

# D64A

1MP Indoor Dome with D/N, Adaptive IR, Vari-focal Lens



- 1 Megapixel with 720p
- Day & Night with Adaptive IR LED
- Vari-focal Lens with f2.8-12mm/ F1.4
- 30 fps at 1280 x 720
- Vandal Resistant (IK09)

## PHOTO INDICATION

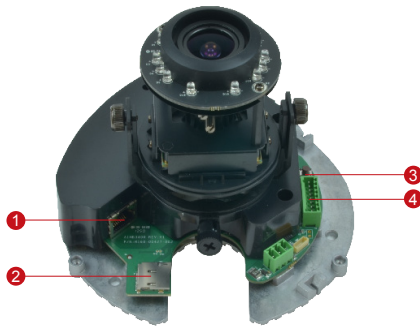

- 1 Ethernet Port
- 2 Memory Card Slot
- 3 Reset Button
- 4 Digital Input/Output and Audio-In / Audio-out

## DIMENSION DIAGRAM

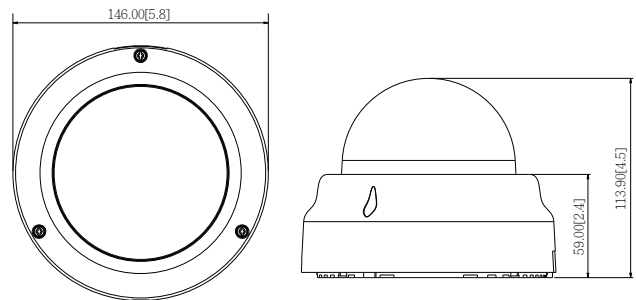







Unit: mm [inch]

## ACCESSORY OPTIONS

Dome Cover		
PDCX-1101		4-inch, smoked, vandal proof (IK10)

Power Supply		
PPOE-0001		IEEE 802.3af PoE Injector for Class 1, 2 or 3 devices, with universal adapter

Popular Mounting Solutions		
Surface	Accessories not required	
Wall	PMAX-0313	
Pendant	PMAX-0101 PMAX-0103	
Corner	PMAX-0313 PMAX-0402	
Pole	PMAX-0313 PMAX-0503	
Flush	PMAX-1003	
Gang Box	PMAX-0803	

\* For more mounting solutions, please refer to Project Planner on [www.acti.com](http://www.acti.com)

**PRODUCT SPECIFICATION****D64A****• Device**

Device Type	Indoor Dome Camera
Image Sensor	Progressive Scan CMOS
Sensor Size	1/4"
Effective Pixels	1280 (H) x 800 (V) (1.02 MP)
Horizontal Resolution	700 TVL
Day / Night	Yes
Low Light Sensitivity	Standard
Minimum Illumination	Color: 0.1 lux at F1.4 (30 IRE, 2400°K); B/W: 0 lux (IR LED on)
Color to B/W Switch	ISP based switch, configurable
Mechanical IR Cut Filter	Yes
IR Sensitivity Range	700~1100nm
IR LED	Adaptive IR LED x 15 (850nm)
IR Working Distance	30 m (0 lux, 30 IRE, Gain 255 auto shutter mode)
Electronic Shutter	1/5 ~ 1/2,000 sec (manual mode); 1/5 ~ 1/10,000 sec (auto mode)
S/N Ratio	52 dB

**• Lens**

Focal Length / Aperture	Vari-focal, f2.8 - 12 mm / F1.4
Iris	Fixed iris
Focus	Manual focus
Mount Type	Board mount
Horizontal Viewing Angle	59.8° - 24.7°
Viewing Angle Adjustment	Pan: 0° - 350°; Tilt: 17° - 163°; Rotate: 0° - 350°

**• Video**

Compression	H.264 (Baseline/ Main/ High profile), MJPEG
Max. Frame Rate vs. Resolution	30 fps at 1280 x 720; 30 fps at 800 x 600; 30 fps at 640 x 480; 15 fps at 320 x 240
Multi-Streaming	Simultaneous dual streams based on two configurations
Bit Rate	28 Kbps - 6 Mbps (per stream)
Bit Rate Mode	Constant, Variable
Image Enhancement	White balance: automatic, hold, and manual; Brightness; Contrast; Sharpness (auto); Auto gain control; Digital noise reduction; Flickerless
Privacy Mask	4 configurable regions
Text Overlay	User defined text on video
Image Orientation	Image flip and mirror

**• Audio**

Compression	8 kHz, Mono, PCM, 16 bit encoding; G.711
Audio-In	Terminal block
Audio-Out	Terminal block

**• Network**

Protocol & Service	TCP, UDP, HTTP, HTTPS, DHCP, PPPoE, RTP, RTSP, IPv4, IPv6, DNS, DDNS, NTP, ICMP, ARP, IGMP, SMTP, FTP, UPnP, SNMP, Bonjour
Ethernet Port	1, Ethernet (10/100 Base-T), RJ-45 connector
Security	IP address filtering; HTTPS encryption; Password protected user levels; Anonymous login; IEEE802.1X network access control

**• Alarm**

Alarm Trigger	Video motion detection (3 regions); External device through digital input; Sound detection
Alarm Response	Notify control center; Change camera settings; Command other devices; E-mail notification with snapshots; Save video or snapshot to local storage; Upload video, snapshot to FTP; Activate external device through digital output

**• Interface**

Digital Input	1, Terminal block
Digital Output	1, Terminal block
Local Storage	MicroSDHC/MicroSDXC memory card slot (card not included)

**• General**

Power Source / Consumption	PoE Class 2 (IEEE802.3af) / 5.95 W (IR on)
Weight	538g (1.186 lb)
Dimensions (Ø x H)	146 mm x 114 mm (5.75" x 4.5")
Environmental Casing	Vandal resistant (IK09 rated); Transparent dome cover
Mount Type	Surface, Pendant, Wall, Corner, Pole, Flush, Gang box
Starting Temperature	-10°C ~ 50°C (14°F ~ 122°F)
Operating Temperature	-10°C ~ 50°C (14°F ~ 122°F)
Operating Humidity	10% ~ 85% RH
Approvals	CE (EN 55022 Class B, EN 55024), FCC (Part15 Subpart B Class B), IK09, UL (for optional PoE injector)

**• Integration**

Unified Solution	Fully compatible with ACTi software
ISV Integration	Software Development Kit (SDK) available; ONVIF compliant
GPS Position	Manual Setting
Firmware Access Browser	Microsoft Internet Explorer 8.0 or newer (full functionality) Safari with QuickTime installed, and other browsers with VLC installed (partial functionality)

\* All specifications are subject to change without notice.

\* All brand names and registered trademarks are the property of their respective owners.

[www.acti.com](http://www.acti.com)