

# Installation and Operation

## Service Bypass Panel

**SBP20KP  
SBP20KRMT4U  
SBP20KRMI4U**

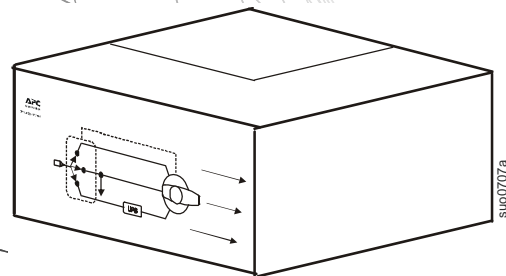



---

This manual and the safety guide are available in English on the enclosed CD and the APC Web site, [www.apc.com](http://www.apc.com).

Uživatelská příručka a bezpečnostní pokyny jsou k dispozici v češtině na příloženém CD a na webových stránkách APC - [www.apc.com](http://www.apc.com).

Denne vejledning og sikkerhedsvejledningen er tilgængelige på dansk på den vedlagte CD og på APC's websted, [www.apc.com](http://www.apc.com).

Dieses Handbuch sowie die Sicherheitsrichtlinien sind in deutscher Sprache auf der beiliegenden CD und auf der Website von APC unter [www.apc.com](http://www.apc.com) verfügbar.

Este manual y la guía de seguridad están disponibles en español en el CD adjunto y en el sitio Web de APC, [www.apc.com](http://www.apc.com).

Ce manuel et le guide de sécurité sont disponibles en français sur le CD-ROM ci-inclus et sur le site Web d'APC, [www.apc.com](http://www.apc.com).

A használati utasítás és a biztonsági útmutató megtalálható magyarul a csatolt CD-n és az APC honlapján: [www.apc.com](http://www.apc.com).

Il presente manuale e la corrispondente Guida per la sicurezza sono disponibili in italiano sul CD-ROM allegato e sul sito Web di APC all'indirizzo [www.apc.com](http://www.apc.com).

Deze handleiding en het veiligheidshandboek staan in het Nederlands op de bijgevoegde cd en op de APC-website: [www.apc.com](http://www.apc.com).

En norsk versjon av denne håndboken og sikkerhetsveiledningen finnes på den vedlagte CD-en og på APCs webområde [www.apc.com](http://www.apc.com).

Este manual e o guia de segurança estão disponíveis em português no CD incluso e no website da APC, [www.apc.com](http://www.apc.com).

Instrukcja obsługi oraz przewodnik bezpieczeństwa w języku polskim dostępne są na załączonej płycie CD i na stronie internetowej APC, [www.apc.com](http://www.apc.com).

Denna manual och säkerhetsguide finns tillgänglig på svenska på medföljande CD och på APC:s webbsida, [www.apc.com](http://www.apc.com).

Bu kılavuzun ve güvenlik kılavuzunun Türkçe versiyonu ürünle birlikte verilen CD'de ve [www.apc.com](http://www.apc.com) adresindeki APC web sitesinde bulunmaktadır.

Panduan dan petunjuk keselamatan ini tersedia dalam Bahasa Inggris pada CD terlampir dan pada Situs APC, [www.apc.com](http://www.apc.com).

本書及び安全ガイドの日本語版は、同梱のCD及びAPCのWebサイト ([www.apc.com](http://www.apc.com)) からご覧いただけます。

이 매뉴얼과 안전 가이드는 동봉된 CD 와 APC 웹사이트 [www.apc.com](http://www.apc.com) 에서 한글로 이용할 수 있습니다 .

Англоязычный вариант данного руководства и руководства по технике безопасности имеется на прилагаемом компакт-диске, а также на сайте компании APC: [www.apc.com](http://www.apc.com).

คำแนะนำด้านความปลอดภัยและคู่มือที่เป็นภาษาไทย สามารถดูได้ในซีดีที่ให้มาและเว็บไซต์ของ APC, [www.apc.com](http://www.apc.com)

您可以從隨附的 CD 與 APC 網站 ([www.apc.com](http://www.apc.com)) 上獲得本手冊與安全指南的中文版本

Το εγχειρίδιο αυτό και ο οδηγός ασφάλειας είναι διαθέσιμα στα ελληνικά στο CD που εσωκλείεται και στην ιστοσελίδα της APC, [www.apc.com](http://www.apc.com).

# Overview

The APC® by Schneider Electric service bypass panel (SBP), provides utility power to connected equipment during UPS maintenance.

## Inventory

**Read the Safety Guide before installing the UPS.**

Inspect the SBP upon receipt. Notify the carrier and dealer if there is damage.

The package is recyclable; save it for reuse or dispose of it properly.

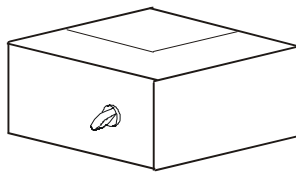

**Literature Kit:**

- Product documentation
- Safety Guide
- Warranty card
- Allen wrench



(1)



Rail Kit

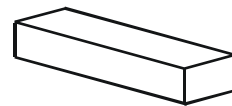

Installation Kit

**Installation Kit Contents**

<p>(8)</p>	<p>(8)</p>	<p>(8)</p>	<p>(2)</p>
<p>(1 pair)</p>	<p>(1 pair)</p>	<p>(1 pair)</p>	<p>(1 pair)</p>

# Specifications

## Electrical Specifications

SBP model	Rated Input Voltage	Rated Output Voltage	Input Current maximum	Output Power Watts/VA maximum
SBP20KP	200/208/240 VAC 50/60 Hz, 2P+PE	200/208/240 VAC 50/60 Hz, 2P+PE	125 A each phase	30,000
	220/230/240 VAC 50/60 Hz, 1P+N+PE	220/230/240 VAC 50/60 Hz, 1P+N+PE	125 A each phase	30,000
	380/400/415 VAC 50/60 Hz, 3P+N+PE	220/230/240 VAC 50/60 Hz, 1P+N+PE	125 A each phase	30,000
SBP20KRMT4U	200/208/240 VAC 50/60 Hz, 2P+PE	200/208/240 VAC 50/60 Hz, 2P+PE	125 A each phase	30,000
SBP20KRMI4U	220/230/240 VAC 50/60 Hz, 1P+N+PE	220/230/240 VAC 50/60 Hz, 1P+N+PE	125 A each phase	30,000
	380/400/415 VAC 50/60 Hz, 3P+N+PE	220/230/240 VAC 50/60 Hz, 1P+N+PE	125 A each phase	30,000



**Note:** The table above represents the electrical ratings of the SBP and not those of the UPS.

UPS wire specifications may vary. The SBP requires a minimum wire size of 25 mm<sup>2</sup> and a maximum wire size of 50 mm<sup>2</sup>. Refer to the UPS user manual for UPS wiring specifications.

SBP ratings must be equal to or greater than those of the UPS to which it is connected.

The input circuit breaker should not exceed the rating recommended on the UPS.

The system load must not exceed the electrical rating of the UPS. For example, if a 3840 VA SBP is used with a 3000 VA UPS the maximum load that the system will support is 3000 VA.

## Environmental Specifications

Temperature	Operating	0° to 40° C (32° to 104° F)	This unit is intended for indoor use only.
	Storage	-15° to 45° C (-40° to 113° F)	
Maximum Elevation	Operating	3,000 m (10,000 ft)	Do not operate the service bypass panel where there is excessive dust or the temperature or humidity are outside specified limits.
	Storage	15,000 m (50,000 ft)	
Humidity	0 to 95% relative humidity, non-condensing		Be sure the air vents on the SBP are not blocked. Allow adequate space for proper ventilation.



**Changes and modifications to this unit not expressly approved by APC could void the warranty.**

# Front panel

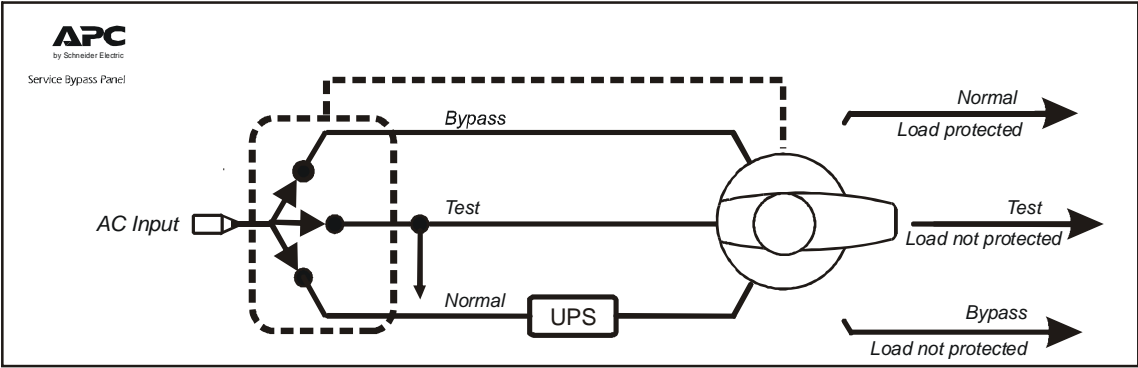

# Rear panels

Callout	Description
1	Equipment outlets
2	Equipment outlet circuit breakers
3	Utility input power hardwire access
4	Output power hardwire access

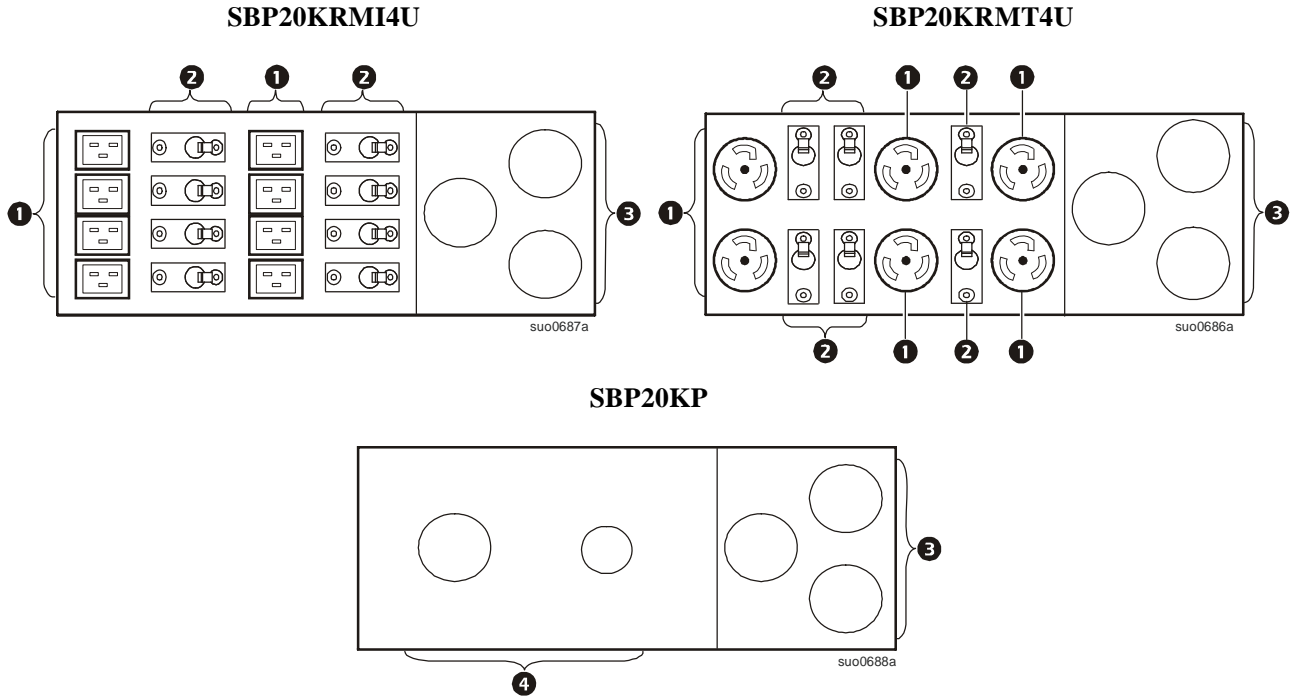

# Installation

## Stack configuration

Always place the SBP above the external battery packs and the UPS.

Four ornamental screws (supplied), must be used to secure each tie bracket to the units, (see diagram).

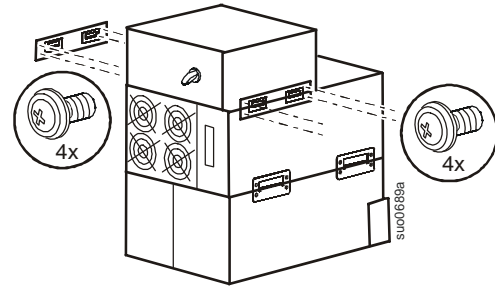

## Rack-mount configuration

### Install rails in rack

For details on rail installation refer to the instructions included in the rail kit.

### Install rack-mount brackets

Secure the brackets to the unit using eight flat head screws (supplied).

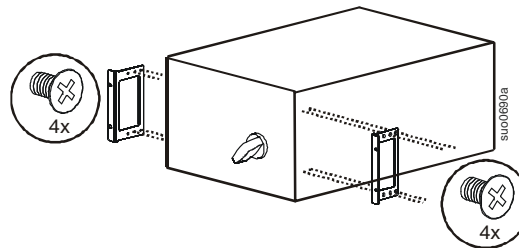

### Install cleats

Secure the cleats to the unit using eight Pan head screws (supplied).

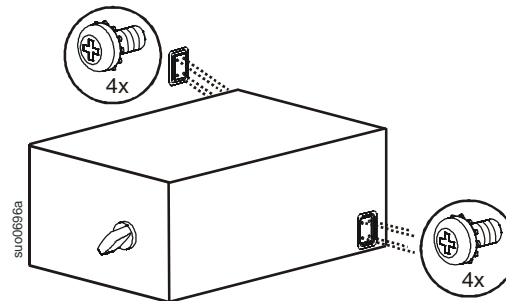

### Install in rack

Always place the SBP above the external battery packs and the UPS.

A cage nut and an ornamental screw (supplied), must be used in the top hole of each rack-mount bracket when securing the unit in the rack.

The bottom hole of each rack-mount bracket must be secured using an ornamental screw (supplied), in the threaded hole.

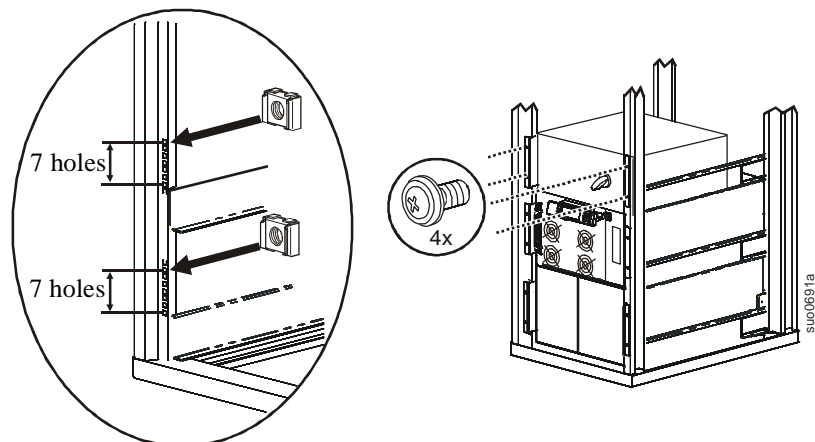

# Wall-mount configuration

Secure the wall-mount brackets to the unit using eight ornamental screws (supplied), four in each bracket.

Secure the SBP to the wall. Select screws (not supplied), that are appropriate for the weight of the unit and the mounting surface material.

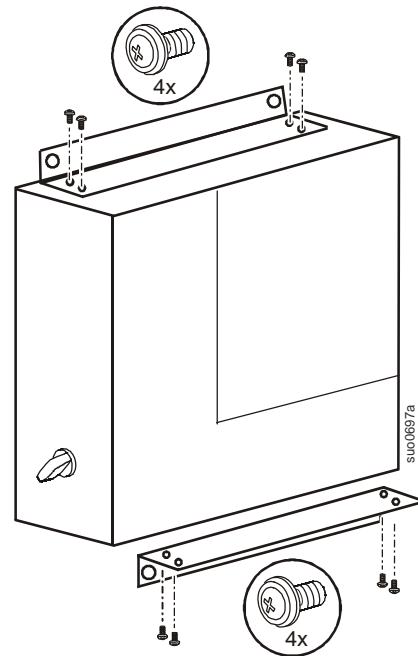

# Hardwire the SBP

Hardwiring must be performed by a qualified electrician.

Adhere to all national and local electrical codes.

Switch the utility circuit breaker off.

Remove the terminal block access panel located on top of the unit.

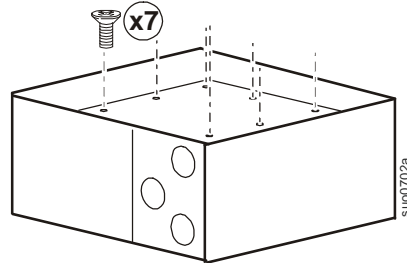

**On all models**, remove the access panel with three knockout pieces.

Remove all three knockout pieces from the panel.

**Model SBP20KP** has two access panels. Remove both of the access panels.

Remove all three knockout pieces from the small panel. Remove one of the knockout pieces from the large panel.

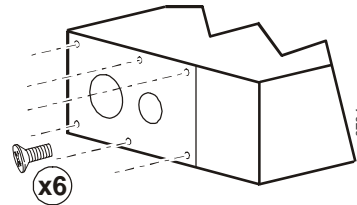
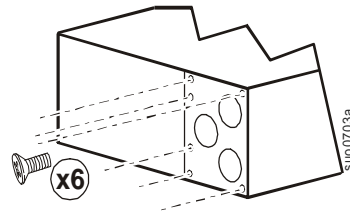

Strip 24 mm (1 inch), of insulation from the cable ends.



Insert cables through the holes in the access panel(s). Connect the ground terminal first.

Install an appropriate strain relief (not supplied), on each cable.

Secure the cables in the terminal blocks. Refer to the terminal block configurations on the following page.

Use the Allen wrench supplied to tighten the terminal block screws.

**Torque terminals to 6 Nm (53 in-lb) minimum, 8 Nm (71 in-lb) maximum.**

Replace the access panel(s) using all of the screws removed in the previous steps. Failure to do so may result in personal injury or equipment damage.

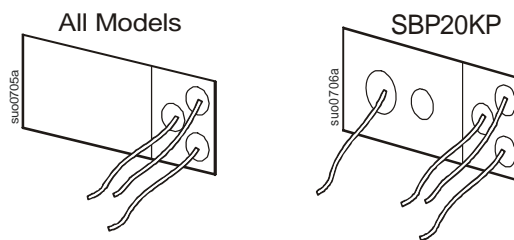



SBP20KRMI4U

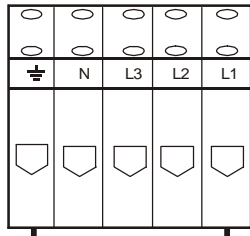

UPS  
INPUT

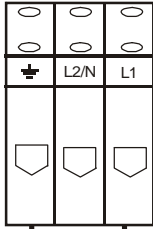

UPS  
OUTPUT

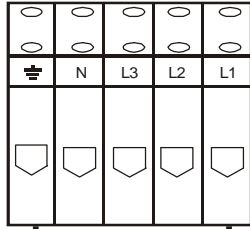

AC LINE  
INPUT

SBP20KRMT4U

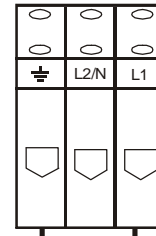

UPS  
INPUT

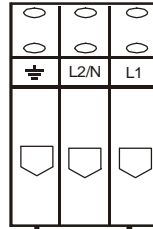

UPS  
OUTPUT

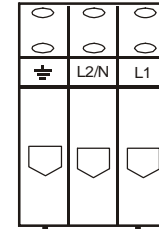

AC LINE  
INPUT

SBP20KP

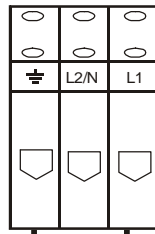

LOAD

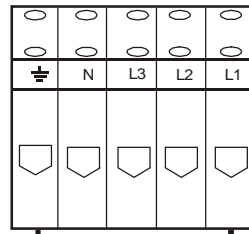

UPS  
INPUT

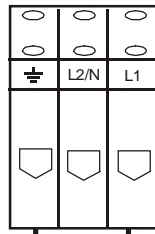

UPS  
OUTPUT

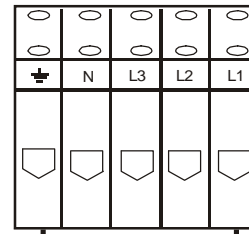

AC LINE  
INPUT

## Hardwire the UPS

Refer to the UPS user manual for detailed instructions.

# Operation

## Normal mode

While the SBP operates in normal mode, power is supplied to connected equipment from the UPS providing protection from power variations and disturbances.

## Test mode

1. Switch the UPS to **Bypass** mode. Verify that no UPS fault conditions exist. In the event that a fault condition exists, refer to the user manuals for the UPS and SBP.
2. Switch the SBP to Test mode.



**Note:** While the SBP is in **Test** mode connected equipment receives direct utility power and is not protected by the UPS.

The UPS will continue to receive input utility power.

The Equipment Protection Policy is not valid while the SBP is operating in **Test** mode.

## Bypass mode

Bypass mode enables connected equipment to operate on utility power while UPS maintenance is performed.

While in SBP **Bypass** mode the UPS will not receive utility input power. The UPS will receive battery power while in SBP **Bypass** mode. Refer to the UPS user manual for shutdown procedures.



**Note:** Connected equipment is not protected by the UPS while the SBP is in **Bypass** mode.

The Equipment Protection Policy is not valid while the SBP is operating in **Bypass** mode.

# Reconnect SBP to UPS

## Bypass mode

1. Put the SBP in **Bypass** mode.
2. Correctly configure the input, output and battery connections on the UPS.  
**DO NOT turn on the UPS at this time.**

## Test mode

1. Switch the SBP to **Test** mode.
  - a. The connected equipment will receive direct input utility power.
  - b. The UPS will receive input utility power.
2. Verify that no UPS fault conditions exist. In the event that a fault condition exists, refer to the user manuals for the UPS and SBP.
3. Turn on the UPS output power.

## Normal mode

1. Switch the UPS to Bypass mode. Verify that no UPS fault conditions exist. In the event that a fault condition exists, refer to the user manuals for the UPS and SBP.
2. Switch the SBP to **Normal** mode.
3. Switch the UPS to **Online** mode. Verify that no UPS fault conditions exist. In the event that a fault condition exists, refer to the user manuals for the UPS and SBP.

The SBP will now supply power to connected equipment from the UPS providing protection from power variations and disturbances.

# Troubleshooting

Use the table to solve minor installation and operation problems.

Refer to the APC Web site, [www.apc.com](http://www.apc.com) for assistance with complex problems.

Problem and/or Possible Cause	Solution
<b>UPS will not turn on</b>	
SBP is in <b>Bypass</b> mode.	Rotate the SBP switch to <b>TEST</b> .
There is no power at the UPS input.	Verify that the power cables from the SBP to the utility power, and from the SBP to the UPS input are securely connected.
UPS is faulty or damaged.	Rotate the SBP switch to <b>Test</b> . If the connected equipment is energized, the UPS may be faulty. Refer to Troubleshooting in the UPS user manual for detailed information.
There is no power at the utility power outlet.	Rotate the SBP switch to <b>Test</b> . If the connected equipment does not become energized, the utility power outlet may be faulty. Verify the utility power supply. Contact a qualified electrician to check the building electrical power.
<b>UPS is Online; not providing power to connected equipment</b>	
SBP output circuit breaker has tripped.	Disconnect all nonessential equipment from the SBP. Reset the SBP circuit breaker.
There is no SBP output power.	Verify that the power cable from the SBP to the UPS output is securely connected.

## Contact information

Customer support for this or any other APC product is available at no charge in any of the following ways: Visit the APC Web site to access documents in the APC Knowledge Base and to submit customer support requests.

- [www.apc.com](http://www.apc.com) (Corporate Headquarters)  
Connect to localized APC Web sites for specific countries, each of which provides customer support information.
- [www.apc.com/support/](http://www.apc.com/support/)  
Global support searching APC Knowledge Base and using e-support.
- Contact the APC Customer Support Center by telephone (888) 272 2782, or by e-mail.  
Local, country-specific centers: go to [www.apc.com/support/contact](http://www.apc.com/support/contact) for contact information. For information on how to obtain local customer support, contact the APC representative or other distributors from whom you purchased your APC product.

# Service

If the unit requires service, do not return it to the dealer. Follow these steps:

1. Review the *Troubleshooting* section of the manual to eliminate common problems.
2. If the problem persists, contact APC Customer Support through the APC Web site, **www.apc.com**.
  - a. Note the model number and serial number and the date of purchase. The model and serial numbers are located on the rear panel of the unit and are available through the LCD display on select models.
  - b. Call APC Customer Support and a technician will attempt to solve the problem over the phone. If this is not possible, the technician will issue a Returned Material Authorization Number (RMA#).
  - c. If the unit is under warranty, the repairs are free.
  - d. Service procedures and returns may vary internationally. Refer to the APC Web site for country specific instructions.
3. Pack the unit in its original packaging. If this is not available, refer to **www.apc.com** to obtain a new set.
  - a. Pack the unit properly to avoid damage in transit. Never use foam beads for packaging. Damage sustained in transit is not covered under warranty.
  - b. **For the UPS, always DISCONNECT THE BATTERY before shipping in compliance with U.S. Department of Transportation (DOT) and IATA regulations.** The battery may remain in the unit.
  - c. Internal batteries may remain connected in the XLBP during shipment, (if applicable, not all units have XLBPs).
4. Write the RMA# provided by Customer Support on the outside of the package.
5. Return the unit by insured, pre-paid carrier to the address provided by Customer Support.

## Transport the unit

1. Shut down and disconnect all connected equipment.
2. Disconnect the unit from utility power.
3. Disconnect all internal and external batteries (if applicable).
4. Follow the shipping instructions outlined in the *Service* section of this manual.

# Two-Year Factory Warranty

This warranty applies only to the products you purchase for your use in accordance with this manual.

## Terms of warranty

APC warrants its products to be free from defects in materials and workmanship for a period of two years from the date of purchase. APC will repair or replace defective products covered by this warranty. This warranty does not apply to equipment that has been damaged by accident, negligence or misapplication or has been altered or modified in any way. Repair or replacement of a defective product or part thereof does not extend the original warranty period. Any parts furnished under this warranty may be new or factory-remanufactured.

## Non-transferable warranty

This warranty extends only to the original purchaser who must have properly registered the product. The product may be registered at the APC Web site, **www.apc.com**.

## Exclusions

APC shall not be liable under the warranty if its testing and examination disclose that the alleged defect in the product does not exist or was caused by end user's or any third person's misuse, negligence, improper installation or testing. Further, APC shall not be liable under the warranty for unauthorized attempts to repair or modify wrong or inadequate electrical voltage or connection, inappropriate on-site operation conditions, corrosive atmosphere, repair, installation, exposure to the elements, Acts of God, fire, theft, or installation contrary to APC recommendations or specifications or in any event if the APC serial number has been altered, defaced, or removed, or any other cause beyond the range of the intended use.

**THERE ARE NO WARRANTIES, EXPRESS OR IMPLIED, BY OPERATION OF LAW OR OTHERWISE, OF PRODUCTS SOLD, SERVICED OR FURNISHED UNDER THIS AGREEMENT OR IN CONNECTION HEREWITH. APC DISCLAIMS ALL IMPLIED WARRANTIES OF MERCHANTABILITY, SATISFACTION AND FITNESS FOR A PARTICULAR PURPOSE. APC EXPRESS WARRANTIES WILL NOT BE ENLARGED, DIMINISHED, OR AFFECTED BY AND NO OBLIGATION OR LIABILITY WILL ARISE OUT OF, APC RENDERING OF TECHNICAL OR OTHER ADVICE OR SERVICE IN CONNECTION WITH THE PRODUCTS. THE FOREGOING WARRANTIES AND REMEDIES ARE EXCLUSIVE AND IN LIEU OF ALL OTHER WARRANTIES AND REMEDIES. THE WARRANTIES SET FORTH ABOVE CONSTITUTE APC'S SOLE LIABILITY AND PURCHASER'S EXCLUSIVE REMEDY FOR ANY BREACH OF SUCH WARRANTIES. APC WARRANTIES EXTEND ONLY TO PURCHASER AND ARE NOT EXTENDED TO ANY THIRD PARTIES.**

**IN NO EVENT SHALL APC, ITS OFFICERS, DIRECTORS, AFFILIATES OR EMPLOYEES BE LIABLE FOR ANY FORM OF INDIRECT, SPECIAL, CONSEQUENTIAL OR PUNITIVE DAMAGES, ARISING OUT OF THE USE, SERVICE OR INSTALLATION, OF THE PRODUCTS, WHETHER SUCH DAMAGES ARISE IN CONTRACT OR TORT, IRRESPECTIVE OF FAULT, NEGLIGENCE OR STRICT LIABILITY OR WHETHER APC HAS BEEN ADVISED IN ADVANCE OF THE POSSIBILITY OF SUCH DAMAGES. SPECIFICALLY, APC IS NOT LIABLE FOR ANY COSTS, SUCH AS LOST PROFITS OR REVENUE, LOSS OF EQUIPMENT, LOSS OF USE OF EQUIPMENT, LOSS OF SOFTWARE, LOSS OF DATA, COSTS OF SUBSTITUENTS, CLAIMS BY THIRD PARTIES, OR OTHERWISE.**

**NO SALESMAN, EMPLOYEE OR AGENT OF APC IS AUTHORIZED TO ADD TO OR VARY THE TERMS OF THIS WARRANTY. WARRANTY TERMS MAY BE MODIFIED, IF AT ALL, ONLY IN WRITING SIGNED BY AN APC OFFICER AND LEGAL DEPARTMENT.**

## Warranty claims

Customers with warranty claims issues may access the APC customer support network through the Support page of the APC Web site, [www.apc.com/support](http://www.apc.com/support). Select your country from the country selection pull-down menu at the top of the Web page. Select the Support tab to obtain contact information for customer support in your region.

© 2010 APC by Schneider Electric. APC, the APC logo, and Smart-UPS are owned by Schneider Electric Industries S.A.S., American Power Conversion Corporation, or their affiliated companies. All other trademarks are property of their respective owners.