

INSTALLATION GUIDE

AXIS T94G01P Conduit Back Box

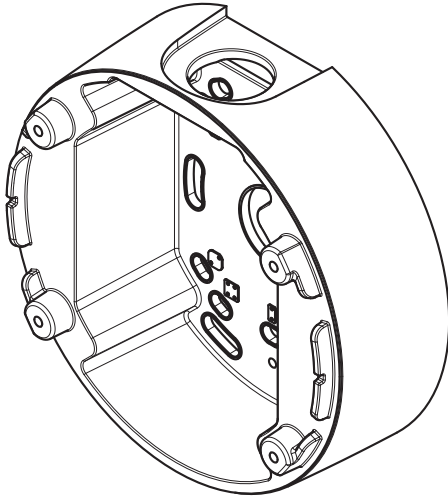

1x

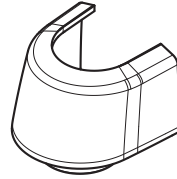

1x

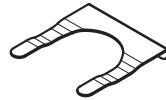

1x

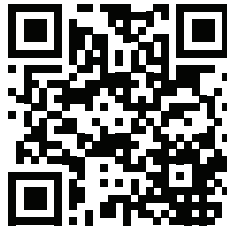

www.axis.com/warranty

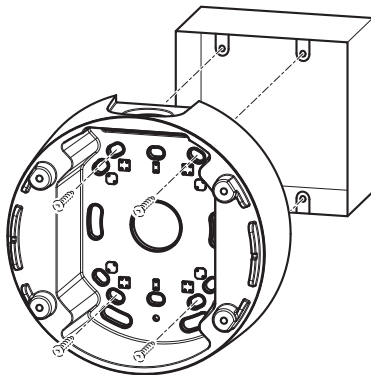
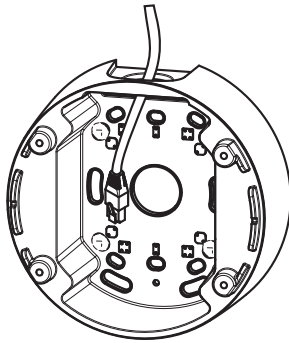
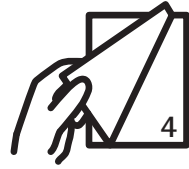
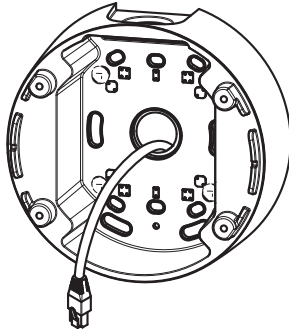

1

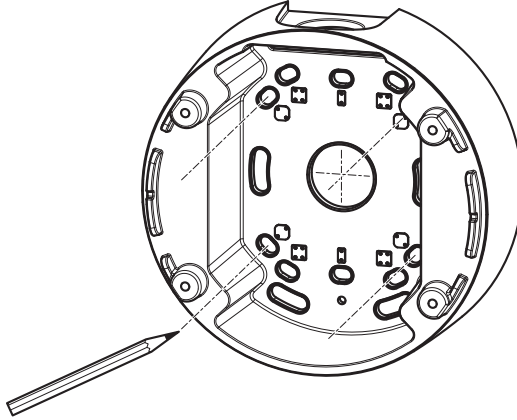

2

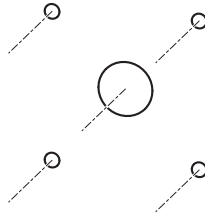
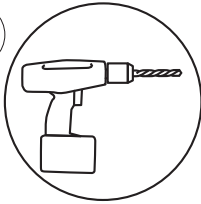

3

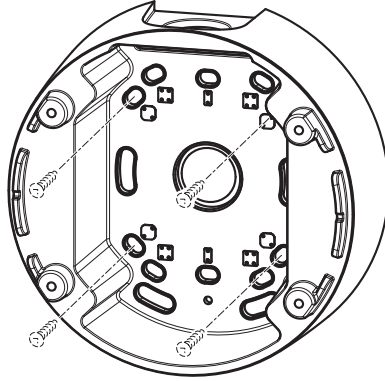

4

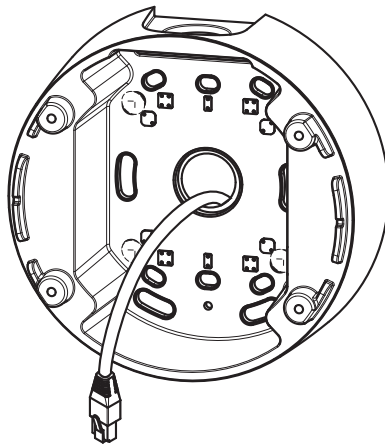

5

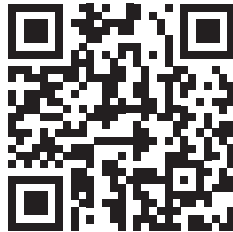
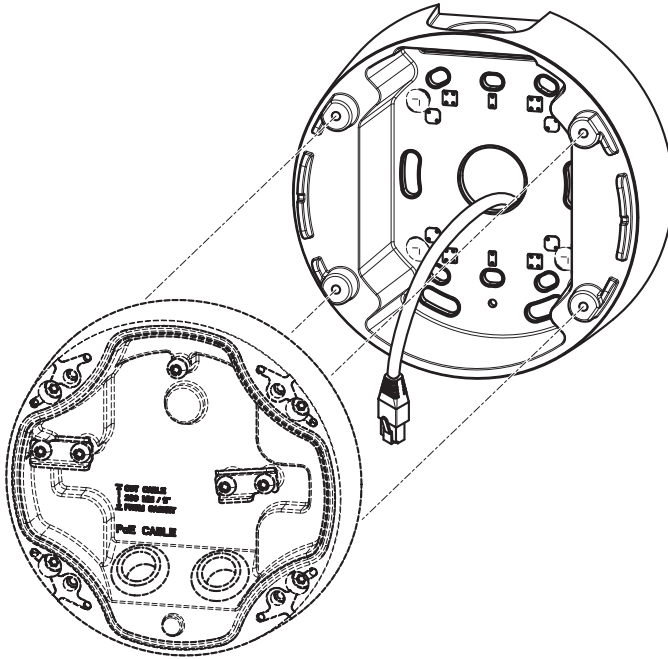

www.axis.com/products/cam_q17651e/

6

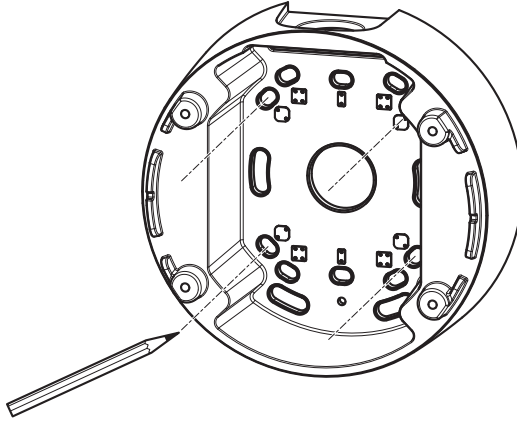

7

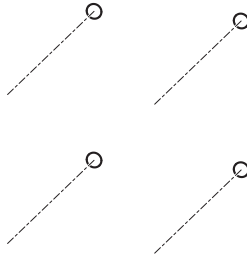
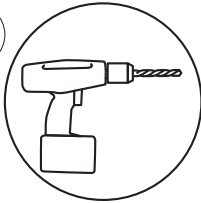

8

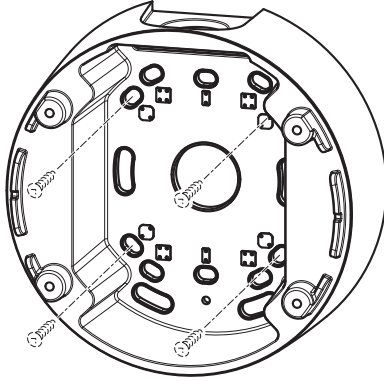

9

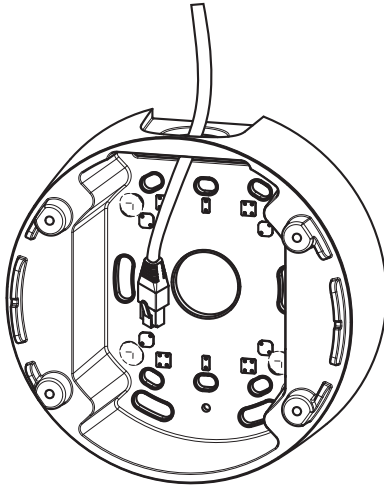

10

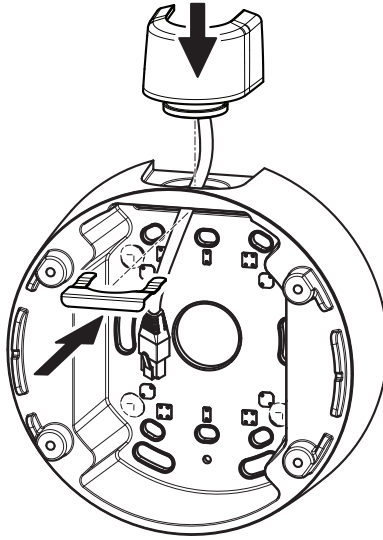

11

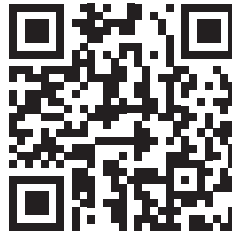
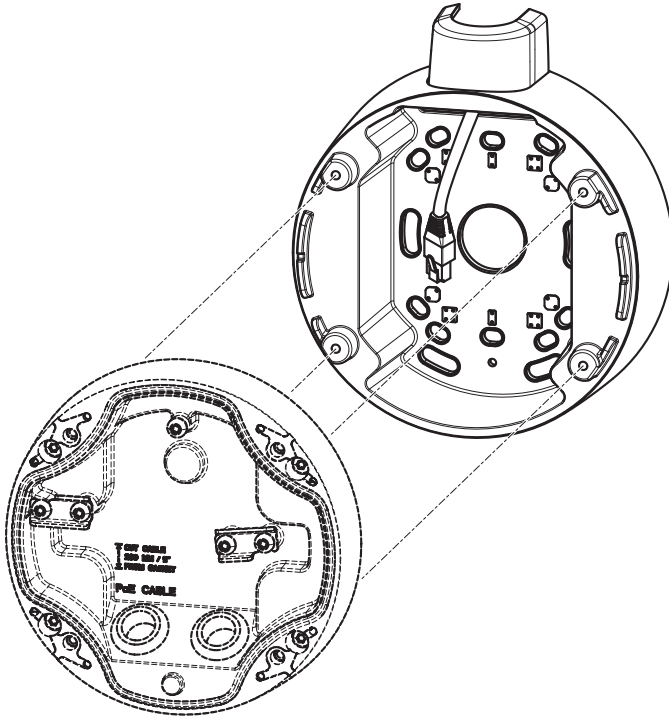

www.axis.com/products/cam_q1765le/

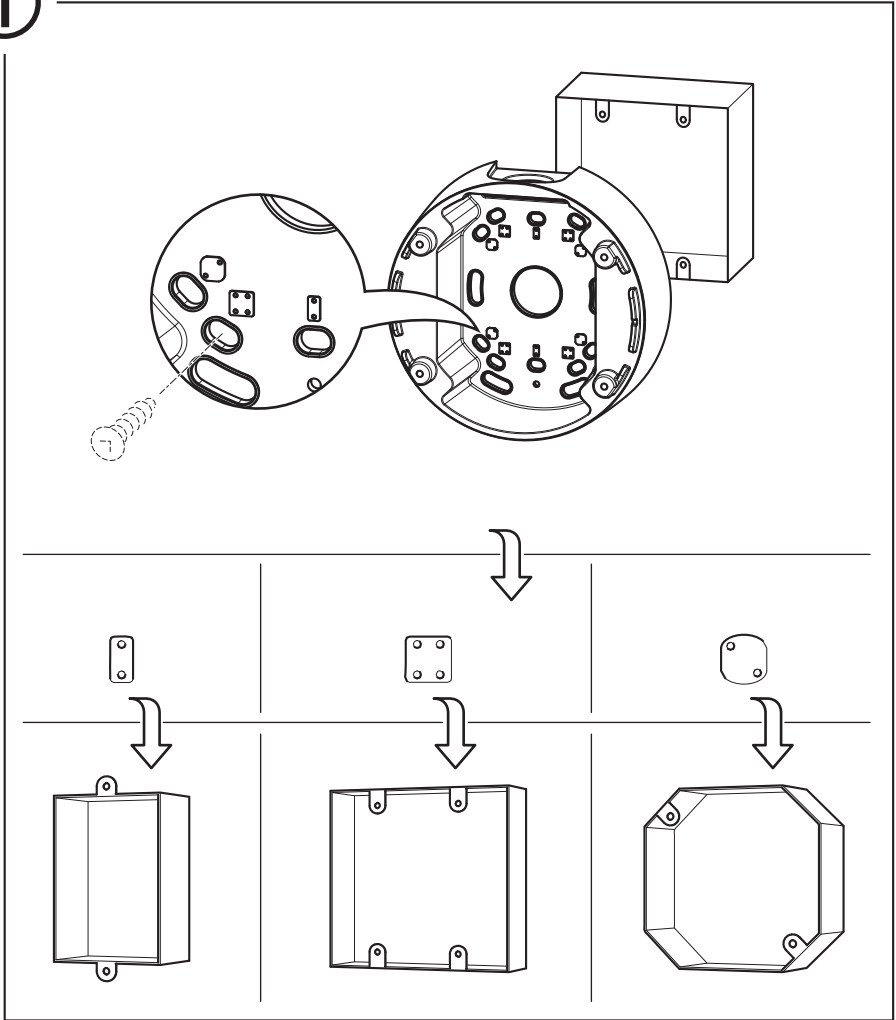

12

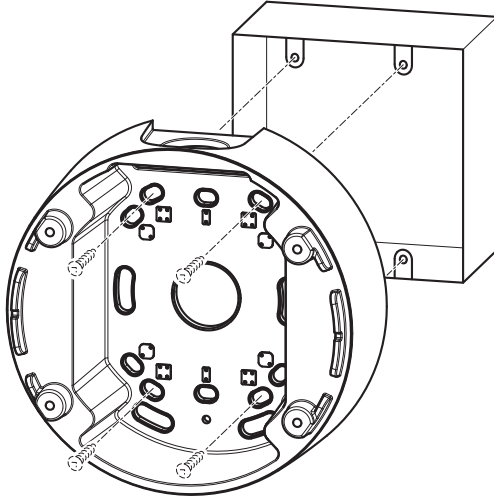

13

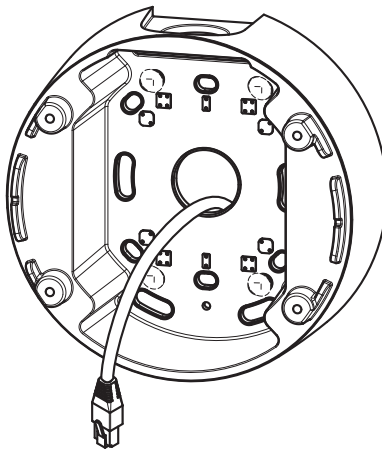

14

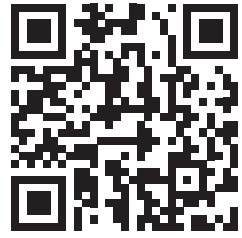
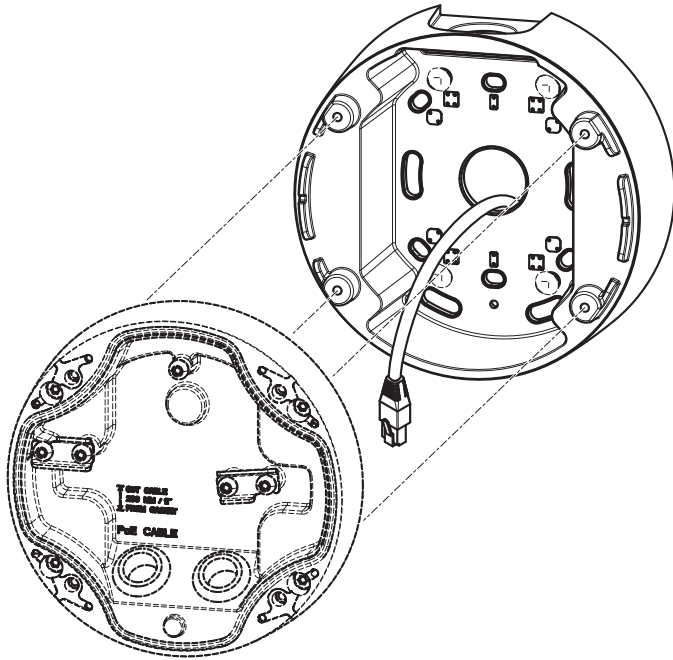

www.axis.com/products/cam_q1765le/

Installation Guide

AXIS T94G01P Conduit Back Box

© Axis Communications AB, 2014

Ver. 1.0

Printed: March 2014

Part No. 56415