

AXIS F1004 Pinhole Sensor Unit

Installation Guide

AXIS F1004 Pinhole Sensor Unit

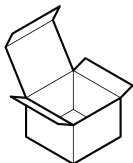

1x

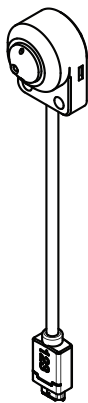

1x

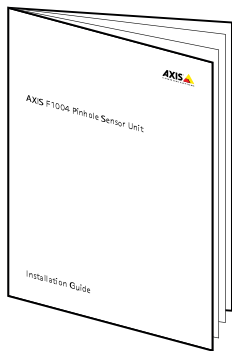

1x

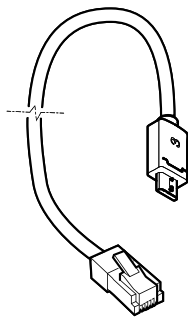

1x

AXIS F1004 Pinhole Sensor Unit

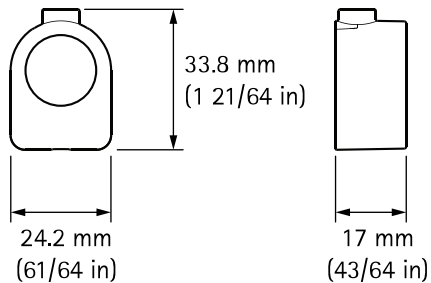
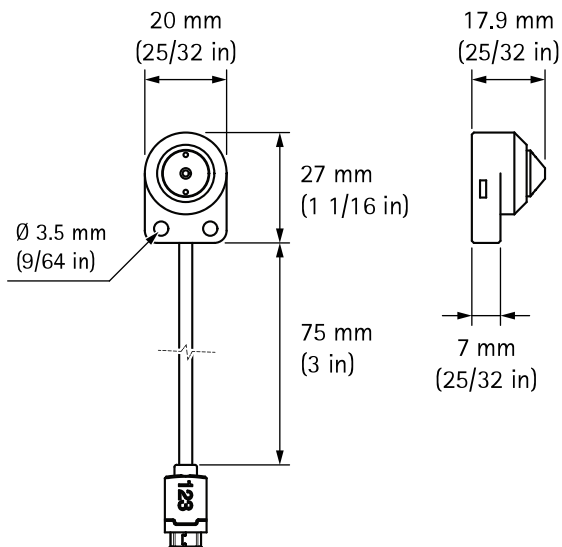

1.1

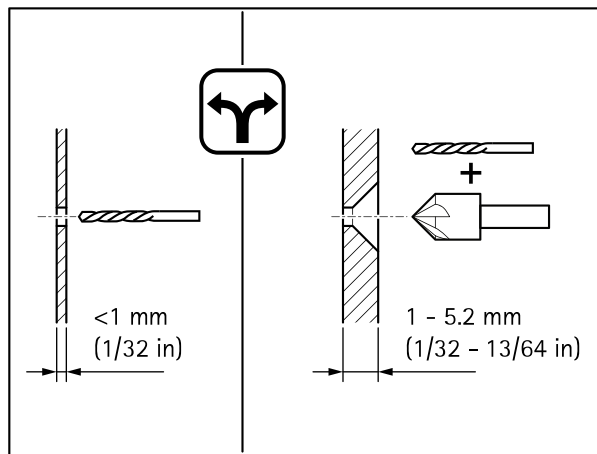
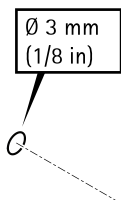
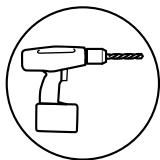

1.2

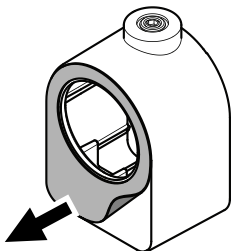

1.3

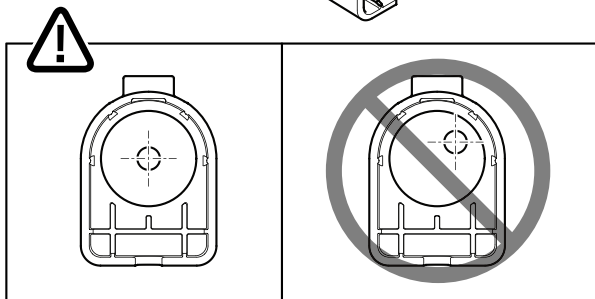
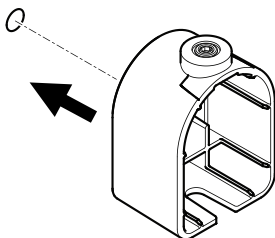

1.4

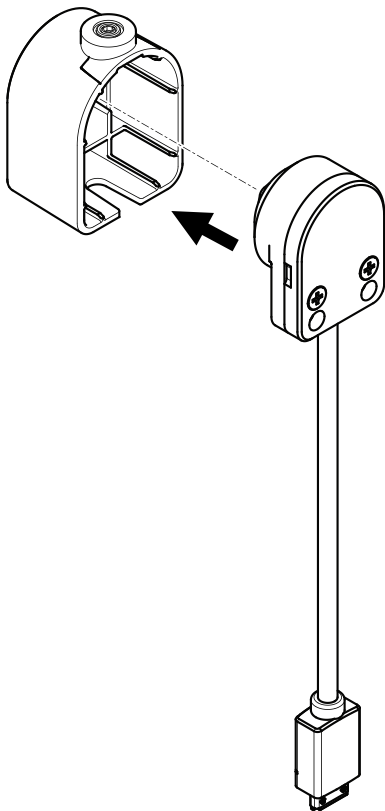

1.5

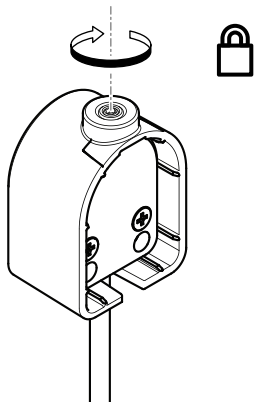

1.6

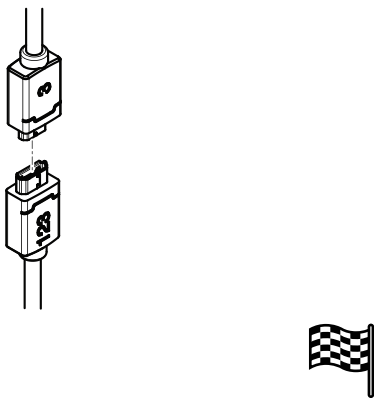

Legal Considerations

Video and audio surveillance can be regulated by laws that vary from country to country. Check the laws in your local region before using this product for surveillance purposes.

Liability

Every care has been taken in the preparation of this document. Please inform your local Axis office of any inaccuracies or omissions. Axis Communications AB cannot be held responsible for any technical or typographical errors and reserves the right to make changes to the product and manuals without prior notice. Axis Communications AB makes no warranty of any kind with regard to the material contained within this document, including, but not limited to, the implied warranties of merchantability and fitness for a particular purpose. Axis Communications AB shall not be liable nor responsible for incidental or consequential damages in connection with the furnishing, performance or use of this material. This product is only to be used for its intended purpose.

Intellectual Property Rights

Axis AB has intellectual property rights relating to technology embodied in the product described in this document. In particular, and without limitation, these intellectual property rights may include one or more of the patents listed at www.axis.com/patent.htm and one or more additional patents or pending patent applications in the US and other countries.

Equipment Modifications

This equipment must be installed and used in strict accordance with the instructions given in the user documentation. This equipment contains no user-serviceable components. Unauthorized equipment changes or modifications will invalidate all applicable regulatory certifications and approvals.

Trademark Acknowledgments

AXIS COMMUNICATIONS, AXIS, ETRAX, ARTPEC and VAPIX are registered trademarks or trademark applications of Axis AB in various jurisdictions. All other company names and products are trademarks or registered trademarks of their respective companies.

Regulatory Information

Europe



This product complies with the applicable CE marking directives and harmonized standards:

- Electromagnetic Compatibility (EMC) Directive 2014/30/EU. See *Electromagnetic Compatibility (EMC) on page 8*.
- Low Voltage (LVD) Directive 2014/35/EU. See *Safety on page 9*.
- Restrictions of Hazardous Substances (RoHS) Directive 2011/65/EU. See *Disposal and Recycling on page 9*.

A copy of the original declaration of conformity may be obtained from Axis Communications AB. See *Contact Information on page 9*.

Electromagnetic Compatibility (EMC)

This equipment has been designed and tested to fulfill applicable standards for:

- Radio frequency emission when installed according to the instructions and used in its intended environment.
- Immunity to electrical and electromagnetic phenomena when installed according to the instructions and used in its intended environment.

USA

Using an unshielded network cable (UTP) – This equipment has been tested using an unshielded network cable (UTP) and found to comply with the limits for a Class A digital device, pursuant to part 15 of the FCC Rules. These limits are designed to provide reasonable protection against harmful interference when the equipment is operated in a commercial environment. This equipment generates, uses, and can radiate radio frequency energy and, if not installed and used in accordance with the instruction manual, may cause harmful interference to radio communications. Operation of this equipment in a residential area is likely to cause harmful interference in which case the user will be required to correct the interference at his own expense.

Using a shielded network cable (STP) – This equipment has also been tested using a shielded network cable (STP) and found to comply with the limits for a Class B digital device, pursuant to part 15 of the FCC Rules. These limits are designed to provide reasonable protection against harmful interference in a residential installation. This equipment generates, uses and can radiate radio frequency energy and, if not installed and used in accordance with the instructions, may cause harmful interference to radio communications. However, there is no guarantee that interference will not occur in a particular installation. If this equipment does cause harmful interference to radio or television reception, which can be determined by turning the equipment off and on, the user is encouraged to try to correct the interference by one or more of the following measures:

- Reorient or relocate the receiving antenna.
- Increase the separation between the equipment and receiver.
- Connect the equipment into an outlet on a circuit different from that to which the receiver is connected.
- Consult the dealer or an experienced radio/TV technician for help.

To be used in a residential area or a demanding electrical environment, the product shall be connected using a shielded network cable (STP) that is properly grounded.

Canada

This digital apparatus complies with CAN ICES-3 (Class B). The product shall be connected using a shielded network cable (STP) that is properly grounded. Cet appareil numérique est conforme à la norme CAN NMB-3 (classe B). Le produit doit être connecté à l'aide d'un câble réseau blindé (STP) qui est correctement mis à la terre.

Europe

This digital equipment fulfills the requirements for RF emission according to the Class B limit of EN 55022. The product shall be connected using a shielded network cable (STP) that is properly grounded.

This product fulfills the requirements for immunity according to EN 61000-6-1 residential, commercial and light-industrial environments.

This product fulfills the requirements for immunity according to EN 61000-6-2 industrial environments.

This product fulfills the requirements for immunity according to EN 55024 office and commercial environments.

Australia/New Zealand

This digital equipment fulfills the requirements for RF emission according to the Class B limit of AS/NZS CISPR 22. The product shall be connected using a shielded network cable (STP) that is properly grounded.

Japan

この装置は、クラスB情報技術装置です。この装置は、家庭環境で使用することを目的としていますが、この装置がラジオやテレビジョン受信機に近接して使用されると、受信障害を引き起こすことがあります。取扱説明書に従って正しい取り扱いをして下さい。本製品は、シールドネットワークケーブル(STP)を使用して接続してください。また適切に接地してください。

Korea

이 기기는 가정용(B급) 전자파적합기로서 주로 가정에서 사용하는 것을 목적으로 하며, 모든 지역에서 사용할 수 있습니다. 적절히 접지된 STP (shielded twisted pair) 케이블을 사용하여 제품을 연결 하십시오.

Safety

This product complies with IEC/EN/UL 60950-1, Safety of Information Technology Equipment.

If its connecting cables are routed outdoors, the product shall be grounded either through a shielded network cable (STP) or other appropriate method.

Disposal and Recycling

When this product has reached the end of its useful life, dispose of it according to local laws and regulations. For information about your nearest designated collection point, contact your local authority responsible for waste disposal. In accordance with local legislation, penalties may be applicable for incorrect disposal of this waste.

Europe



This symbol means that the product shall not be disposed of together with household or commercial waste. Directive 2012/19/EU on waste electrical and electronic equipment (WEEE) is applicable in the European Union member states. To prevent potential harm to human health and the environment, the product must be disposed of in an approved and environmentally safe recycling process. For information about your nearest designated collection point, contact your local authority responsible for waste disposal. Businesses should contact the product supplier for information about how to dispose of this product correctly.

This product complies with the requirements of Directive 2011/65/EU on the restriction of the use of certain hazardous substances in electrical and electronic equipment (RoHS).

China



This product complies with the requirements of the legislative act Administration on the Control of Pollution Caused by Electronic Information Products (ACPEIP).

Contact Information

Axis Communications AB
Emdälavägen 14
223 69 Lund
Sweden

Tel: +46 46 272 18 00
Fax: +46 46 13 61 30

www.axis.com

Support

Should you require any technical assistance, please contact your Axis reseller. If your questions cannot be answered immediately, your reseller will forward your queries through the appropriate channels to ensure a rapid response. If you are connected to the Internet, you can:

- find answers to resolved problems in the FAQ database. Search by product, category, or phrase
- report problems to Axis support staff by logging in to your private support area
- chat with Axis support staff
- visit Axis Support at www.axis.com/techsup/

Learn More!

Visit Axis learning center www.axis.com/academy/ for useful trainings, webinars, tutorials and guides.

English

Safety Information

Read through this Installation Guide carefully before installing the product. Keep the Installation Guide for future reference.

Hazard Levels

⚠ DANGER

Indicates a hazardous situation which, if not avoided, will result in death or serious injury.

⚠ WARNING

Indicates a hazardous situation which, if not avoided, could result in death or serious injury.

⚠ CAUTION

Indicates a hazardous situation which, if not avoided, could result in minor or moderate injury.

NOTICE

Indicates a situation which, if not avoided, could result in damage to property.

Safety Instructions

NOTICE

- The Axis product shall be used in compliance with local laws and regulations.
- Store the Axis product in a dry and ventilated environment.
- Avoid exposing the Axis product to shocks or heavy pressure.
- Avoid exposing the Axis product to vibration.
- Do not install the product on unstable brackets, surfaces or walls.
- Use only applicable tools when installing the Axis product. Using excessive force with power tools could cause damage to the product.
- Do not use chemicals, caustic agents, or aerosol cleaners.
- Use a clean cloth dampened with pure water for cleaning.
- Use only accessories that comply with the technical specification of the product. These can be provided by Axis or a third party.
- Use only spare parts provided by or recommended by Axis.
- Do not attempt to repair the product yourself. Contact Axis support or your Axis reseller for service matters.

Transportation

NOTICE

- When transporting the Axis product, use the original packaging or equivalent to prevent damage to the product.

Français

Informations sur la sécurité

Lisez attentivement ce guide d'installation avant d'installer l'appareil. Conservez le guide d'installation pour toute référence ultérieure.

Niveaux de risques

⚠ DANGER

Indique une situation dangereuse qui, si elle n'est pas évitée, entraînera le décès ou des blessures graves.

⚠ AVERTISSEMENT

Indique une situation dangereuse qui, si elle n'est pas évitée, pourrait entraîner le décès ou des blessures graves.

⚠ ATTENTION

Indique une situation dangereuse qui, si elle n'est pas évitée, pourrait entraîner des blessures légères ou modérées.

AVIS

Indique une situation qui, si elle n'est pas évitée, pourrait endommager l'appareil.

Consignes de sécurité

AVIS

- Le produit Axis doit être utilisé conformément aux lois et réglementations locales en vigueur.
- Conserver ce produit Axis dans un environnement sec et ventilé.
- Ne pas exposer ce produit Axis aux chocs ou aux fortes pressions.
- Ne pas exposer ce produit Axis aux vibrations.
- Ne pas installer ce produit sur des supports, surfaces ou murs instables.
- Utiliser uniquement des outils recommandés pour l'installation de l'appareil Axis. L'application d'une force excessive sur l'appareil avec des outils puissants pourrait l'endommager.
- Ne pas utiliser de produits chimiques, de substances caustiques ou de nettoyeurs pressurisés.
- Utiliser un chiffon propre imbibé d'eau pure pour le nettoyage.
- Utiliser uniquement des accessoires conformes aux caractéristiques techniques du produit. Ils peuvent être fournis par Axis ou un tiers.
- Utiliser uniquement les pièces de rechange fournies ou recommandées par Axis.
- Ne pas essayer de réparer vous-même ce produit. Contacter l'assistance technique d'Axis ou votre revendeur Axis pour des problèmes liés à l'entretien.

Transport

AVIS

- Lors du transport du produit Axis, utilisez l'emballage d'origine ou un équivalent pour éviter d'endommager le produit.

Deutsch

Sicherheitsinformation

Lesen Sie das Installationshandbuch sorgfältig durch bevor sie das Produkt installieren. Bewahren Sie das Installationshandbuch für zukünftige Zwecke auf.

Gefährdungstufen

⚠ GEFAHR

Weist auf eine gefährliche Situation hin, welche , falls nicht verhindert, zu Tod oder schweren Verletzungen führt.

⚠ WARNUNG

Weist auf eine gefährliche Situation hin, welche, falls nicht verhindert, zu Tod oder schweren Verletzungen führen kann.

⚠ VORSICHT

Weist auf eine gefährliche Situation hin, welche, falls nicht verhindert, zu geringfügiger oder mäßiger Verletzung führen kann.

HINWEIS

Weist auf eine gefährliche Situation hin, welche, falls nicht verhindert, zu Sachschäden führen kann.

Sicherheitsanweisungen

HINWEIS

- Die Anwendung des Axis Produkts muss unter Beachtung der örtlich geltenden rechtlichen Bestimmungen erfolgen.
- Lagern Sie das Axis Produkt in einer trockenen und belüfteten Umgebung.
- Achten Sie darauf, dass das Axis Produkt weder Stößen noch starkem Druck ausgesetzt ist.
- Achten Sie darauf, dass das Axis Produkt keinen Vibrationen ausgesetzt ist.
- Installieren Sie das Produkt nicht an instabilen Halterungen, Oberflächen oder Wänden.
- Verwenden Sie bei der Installation des Axis Produkts ausschließlich passende Werkzeuge. Ein zu großer Kraftaufwand mit elektrischen Werkzeugen kann das Produkt beschädigen.
- Verwenden Sie keine chemischen, ätzenden oder aerosolhaltigen Reinigungsmittel.
- Verwenden Sie zum Reinigen ein sauberes, mit destilliertem Wasser angefeuchtetes Tuch.

- Verwenden Sie nur Zubehör, das den technischen Daten des Produkts entspricht. Dieses ist von Axis oder Drittanbietern erhältlich.
- Verwenden Sie ausschließlich Ersatzteile die von Axis bereitgestellt oder empfohlen werden.
- Versuchen Sie nicht, das Produkt selbstständig zu reparieren. Wenden Sie sich bezüglich Reparatur und Wartung an den Axis Support oder Ihren Axis Händler.

Transport

HINWEIS

- Bei Bedarf transportieren Sie das Axis Produkt in der Originalverpackung oder einer entsprechenden Verpackung, so dass Schäden vermieden werden.

Italiano

Informazioni di sicurezza

Leggere con attenzione questa guida all'installazione prima di installare il dispositivo. Conservare questo documento per usi futuri.

Livelli di pericolo

⚠ PERICOLO

Indica una situazione pericolosa che, se non evitata, provoca morte o lesioni gravi.

⚠ AVVERTENZA

Indica una situazione pericolosa che, se non evitata, potrebbe provocare la morte o lesioni gravi.

⚠ ATTENZIONE

Indica una situazione pericolosa che, se non evitata, può provocare lesioni medie o minori.

AWISO

Indica una situazione che, se non evitata, può danneggiare la proprietà.

Informazioni di sicurezza

AWISO

- Il dispositivo Axis deve essere utilizzato in conformità alle leggi e alle disposizioni locali.
- Conservare il dispositivo Axis in un ambiente asciutto e ventilato.
- Evitare di esporre il dispositivo Axis a urti o pressioni eccessive.
- Evitare di esporre il dispositivo Axis a vibrazione.
- Non installare il dispositivo su supporti, superfici o pareti instabili.
- Utilizzare solo strumenti idonei quando si installa il dispositivo Axis. Se si utilizza una forza

ecessiva con strumenti non adatti è possibile causare danni al dispositivo.

- Non utilizzare sostanze chimiche, agenti caustici o detersivi aerosol.
- Utilizzare un panno pulito inumidito in acqua pura per la pulizia.
- Utilizzare solo accessori compatibili con le specifiche tecniche del dispositivo. Questi possono essere forniti da Axis o da terze parti.
- Utilizzare solo parti di ricambio fornite o consigliate da Axis.
- Non tentare di riparare il dispositivo da soli. Contattare l'assistenza o il rivenditore Axis per questioni relative alla manutenzione.

Trasporto

AVISO

- Durante il trasporto del dispositivo Axis, utilizzare l'imballaggio originale o equivalente per evitare danni al dispositivo.

Español

Información de seguridad

Lea esta Guía de instalación con atención antes de instalar el producto. Guarde la Guía de instalación para poder consultarla en otro momento.

Niveles de peligro

▲PELIGRO

Indica una situación peligrosa que, si no se evita, provocará lesiones graves o la muerte.

▲ADVERTENCIA

Indica una situación peligrosa que, si no se evita, puede provocar lesiones graves o la muerte.

▲ATENCIÓN

Indica una situación peligrosa que, si no se evita, puede provocar lesiones moderadas o leves.

AVISO

Indica una situación peligrosa que, si no se evita, puede provocar daños materiales.

Instrucciones de seguridad

AVISO

- El producto de Axis debe utilizarse de acuerdo con las leyes y normativas locales.
- Almacene el producto de Axis en un entorno seco y ventilado.
- Evite la exposición del producto de Axis a choques o a una fuerte presión.
- Evite la exposición del producto de Axis a vibraciones.

- No instale el producto en soportes, superficies o paredes inestables.
- Utilice solo las herramientas correspondientes cuando instale el producto de Axis. La aplicación de una fuerza excesiva con herramientas eléctricas puede provocar daños en el producto.
- No utilice limpiadores en aerosol, agentes cáusticos ni productos químicos.
- Limpie con un paño limpio humedecido con agua pura.
- Utilice solo accesorios que cumplan con las especificaciones técnicas del producto. Estos accesorios los puede proporcionar Axis o un tercero.
- Utilice solo piezas de repuesto proporcionadas o recomendadas por Axis.
- No intente reparar el producto usted mismo. Póngase en contacto con el servicio de asistencia técnica de Axis o con su distribuidor de Axis para tratar asuntos de reparación.

Transporte

AVISO

- Cuando transporte el producto de Axis, utilice el embalaje original o un equivalente para evitar daños en el producto.

日本語

安全情報

本製品を設置する前に、このインストールガイドをよくお読みください。インストールガイドは、後で参照できるように保管しておいてください。

危険レベル

▲危険

回避しない場合、死亡または重傷につながる危険な状態を示します。

▲警告

回避しない場合、死亡または重傷につながるおそれのある危険な状態を示します。

▲注意

回避しない場合、軽傷または中程度の怪我につながるおそれのある危険な状態を示します。

▲注記

回避しない場合、器物の破損につながるおそれのある状態を示します。

安全手順

注記

- 本製品は、お使いになる地域の法律や規制に準拠して使用してください。
- 本製品は乾燥した換気のよい環境に保管してください。
- 本製品に衝撃または強い圧力を加えないでください。
- 本製品に振動を加えないでください。
- 本製品を不安定なプラケット、表面、または壁に設置しないでください。
- 本製品を設置する際には、適切な工具のみを使用してください。電動工具を使用して過剰な力をかけると、製品が損傷することがあります。
- 化学薬品、腐食剤、噴霧式クリーナーは使用しないでください。
- 清掃には、きれいな水に浸した清潔な布を使用してください。
- 製品の技術仕様準拠したアクセサリーのみを使用してください。これらのアクセサリーは、Axisまたはサードパーティから入手できます。
- Axisが提供または推奨する交換部品のみを使用してください。
- 製品を自分で修理しないでください。修理については、Axisサポートまたは販売代理店にお問い合わせください。

輸送

注記

- 本製品を運搬する際は、製品が損傷しないよう、元の梱包が同等の梱包を使用してください。

Português

Informações de segurança

Leia com atenção este Guia de Instalação até o final antes de instalar o produto. Guarde o Guia de Instalação para referência futura.

Níveis de perigo

▲ PERIGO

Indica uma situação perigosa que, se não evitada, irá resultar em morte ou lesões graves.

▲ ATENÇÃO

Indica uma situação perigosa que, se não evitada, poderá resultar em morte ou lesões graves.

▲ CUIDADO

Indica uma situação perigosa que, se não evitada, poderá resultar em lesões leves ou moderadas.

AVISO

Indica uma situação perigosa que, se não evitada, poderá resultar em danos à propriedade.

Instruções de segurança

AVISO

- O produto Axis deve ser usado em conformidade com as leis e regulamentações locais.
- Armazene o produto Axis em um ambiente seco e ventilado.
- Evite expor o produto Axis a impactos ou pressão elevada.
- Evite expor o produto Axis a vibrações.
- Não instale o produto em suportes, superfícies ou paredes instáveis.
- Use apenas as ferramentas recomendadas ao instalar o produto Axis. O uso de força excessiva com ferramentas elétricas poderia danificar o produto.
- Não use produtos químicos, agentes cáusticos ou limpadores aerossóis.
- Use um pano limpo úmido para limpar o produto.
- Utilize apenas acessórios que atendam às especificações técnicas do produto. Esses poderão ser fornecidos pela Axis ou por terceiros.
- Utilize apenas peças sobressalentes fornecidas ou recomendadas pela Axis.
- Não tente reparar o produto por conta própria. Entre em contato com o suporte ou seu revendedor Axis para quaisquer questões relacionadas a serviços.

Transporte

AVISO

- Ao transportar o produto Axis, use a embalagem original ou equivalente para evitar danos ao produto.

РУССКИЙ

Сведения по безопасности

Перед установкой изделия внимательно ознакомьтесь с руководством по установке. Сохраните его для дальнейшего использования.

Уровни опасности

▲ ОПАСНО

Опасная ситуация, которая, если ее не устранить, приведет к смерти или опасным травмам.

▲ ОСТОРОЖНО

Опасная ситуация, которая, если ее не устранить, может привести к смерти или опасным травмам.

▲ ВНИМАНИЕ

Опасная ситуация, которая, если ее не устранить, может привести к травмам незначительной или средней тяжести.

УВЕДОМЛЕНИЕ

Опасная ситуация, которая, если ее не устранить, может вызвать повреждение имущества.

Правила безопасности

УВЕДОМЛЕНИЕ

- Это изделие Axis должно использоваться в соответствии с местными законами и нормативами.
- Устройство Axis должно храниться в сухом, хорошо проветриваемом помещении.
- Не допускайте ударов или приложения высокого давления к устройству Axis.
- Не допускайте сотрясения устройства Axis.
- Не монтируйте устройство на неустойчивых кронштейнах, поверхностях или стенах.
- При установке устройства Axis используйте только предназначенные для этого инструменты. Приложение чрезмерных усилий к инструментам может привести к повреждению устройства.
- Не используйте химикалии, едкие вещества или аэрозольные очистители.
- Для очистки используйте чистую ткань, смоченную чистой водой.
- Используйте только принадлежности, которые соответствуют техническим характеристикам устройства. Они могут поставляться компанией Axis или сторонним производителем.
- Используйте только запасные части, поставляемые или рекомендованные компанией Axis.
- Не пытайтесь отремонтировать устройство самостоятельно. По вопросам обслуживания обращайтесь в службу поддержки Axis или к своему реселлеру Axis.

Транспортировка

УВЕДОМЛЕНИЕ

- При транспортировке устройства Axis используйте оригинальную упаковку или ее эквивалент во избежание повреждения изделия.

中文

安全信息

安装该产品前请仔细阅读该安装指南。请保管好安装指南以供以后查阅。

危险等级

⚠危险

表示有危险的情形, 如果不能避免, 将导致死亡或严重的个人伤害。

⚠警告

表示有危险的情形, 如果不能避免, 将导致死亡或严重的个人伤害。

⚠小心

表示有危险的情形, 如果不能避免, 将导致轻微或中度的个人伤害。

注意

表示一种情形, 如果不能避免, 将导致对财产的损坏。

安全说明

注意

- 使用该安讯士产品必须符合当地法律法规要求。
- 安讯士产品应存放在干燥通风的环境中。
- 应避免对安讯士产品造成冲撞或重压。
- 应避免对安讯士产品造成振动。
- 不得将本产品安装于不稳固的支架、表面或墙面上。
- 安装安讯士产品时, 请使用适用工具。使用电动工具时过度用力可能对产品造成损坏。
- 请勿使用化学制剂、腐蚀性制剂或气雾性清洁剂。
- 使用浸有净水的干净抹布进行清洁。
- 所用附件必须符合该产品的技术规格要求。可由安讯士或第三方供应商提供。
- 必须使用安讯士提供或推荐的零件。
- 请勿试图自己修理该产品。维修事务请联系安讯士支持人员或您的安讯士经销商。

运输

注意

- 安讯士产品运输途中, 应使用其原包装或等效包装, 以防对产品造成损坏。

한국어

안전 정보

제품을 설치하기 전에 설치 안내서를 주의 깊게 읽어보시고 설치 안내서를 보관하여 향후 참조하시기 바랍니다.

위험 레벨

⚠위험

방지하지 않을 경우 사망이나 심각한 상해가 발생할 수 있는 위험한 상황을 나타냅니다.

⚠ 경고

방지하지 않을 경우 사망이나 심각한 상해가 발생할 수 있는 위험한 상황을 나타냅니다.

⚠ 주의

방지하지 않을 경우 경미한 상해가 발생할 수 있는 위험한 상황을 나타냅니다.

주의 사항

방지하지 않을 경우 재산 피해가 발생할 수 있는 상황을 나타냅니다.

안전 지침

주의 사항

- 본 Axis 제품은 해당 지역 법률 및 규정을 준수하여 사용해야 합니다.
- 통풍이 잘되고 건조한 장소에 Axis 제품을 보관하십시오.
- Axis 제품에 충격이나 강한 압력을 가하지 마십시오.
- Axis 제품에 진동을 가하지 마십시오.
- 불안정한 브래킷, 표면 또는 벽에 제품을 설치하지 마십시오.
- Axis 제품을 설치할 때에는 적합한 도구만을 사용하십시오. 전원 도구에 과도한 힘을 가하면 제품이 손상될 수 있습니다.
- 화학약품, 부식제 또는 에어로졸 세정제를 사용하지 마십시오.
- 깨끗한 물에 적신 천을 사용하여 닦으십시오.
- 해당 제품의 기술 사양을 준수하는 액세서리만 사용하십시오. 이러한 액세서리는 Axis 또는 타사에서 구입할 수 있습니다.
- Axis가 제공하거나 권장하는 예비 부품만 사용하십시오.
- 고객이 직접 제품을 수리하지 마십시오. 서비스 문제에 대해서는 Axis 지원 팀이나 해당 지역 Axis 리셀러에게 문의하십시오.

운반

주의 사항

- Axis 제품을 운반할 때는 원래 포장이나 이에 준하는 포장을 사용해 제품이 손상되지 않도록 하십시오.

Installation Guide

AXIS F1004 Pinhole Sensor Unit

© Axis Communications AB, 2016

Ver. M1.6

Date: June 2016

Part No. 1596135