

AXIS M30-P Network Camera Series

AXIS M3047-P Network Camera

AXIS M3048-P Network Camera

User Manual

AXIS M30-P Network Camera Series

Table of Contents

Solution overview	3
Product overview	4
Quick start guide	5
Setup	12
How to access the product	12
About the product's built-in help	13
About capture modes	13
How to choose video compression format	14
How to reduce bandwidth and storage	15
How to reduce noise in low-light conditions	15
How to select exposure mode	15
How to set up a monitor	15
How to trigger an action	16
About overlays	16
About applications	16
Troubleshooting	17
How to reset to factory default settings	17
How to check the current firmware	17
How to upgrade the firmware	17
Technical issues, clues and solutions	18
Performance considerations	19
Specifications	20
SD card slot	20
Buttons	20
Connectors	20

AXIS M30-P Network Camera Series

Solution overview

Solution overview

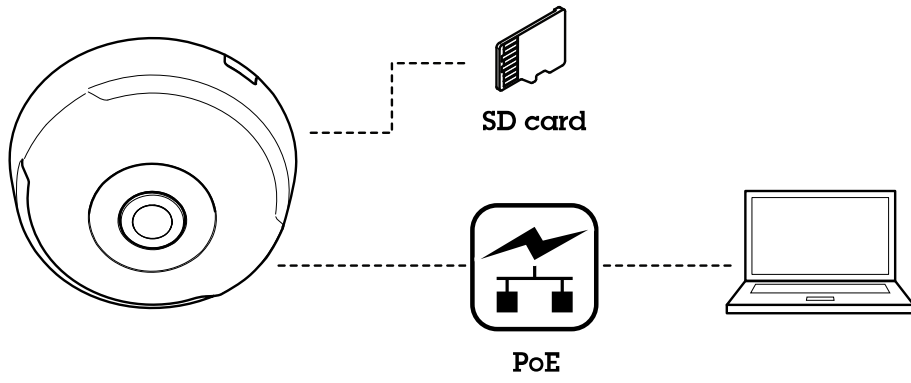

AXIS M30-P Network Camera Series

Product overview

Product overview

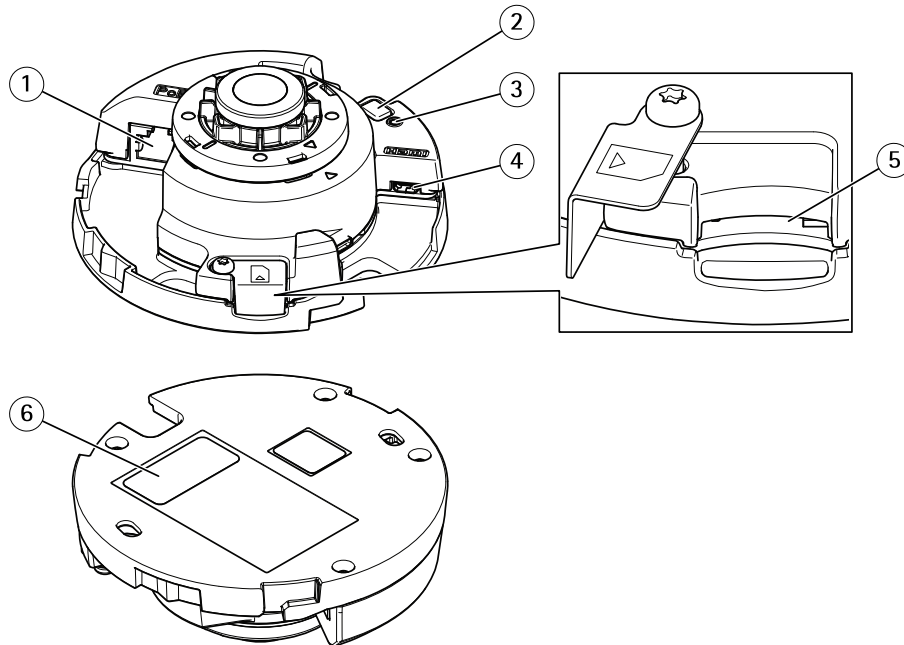

- 1 Network connector (PoE)
- 2 Control button
- 3 Status LED indicator
- 4 HDMI out connector
- 5 SD card slot
- 6 Part number (P/N) & Serial number (S/N)

AXIS M30-P Network Camera Series

Quick start guide

Quick start guide

After starting up the camera for the first time, create a login and start the Get started guide.

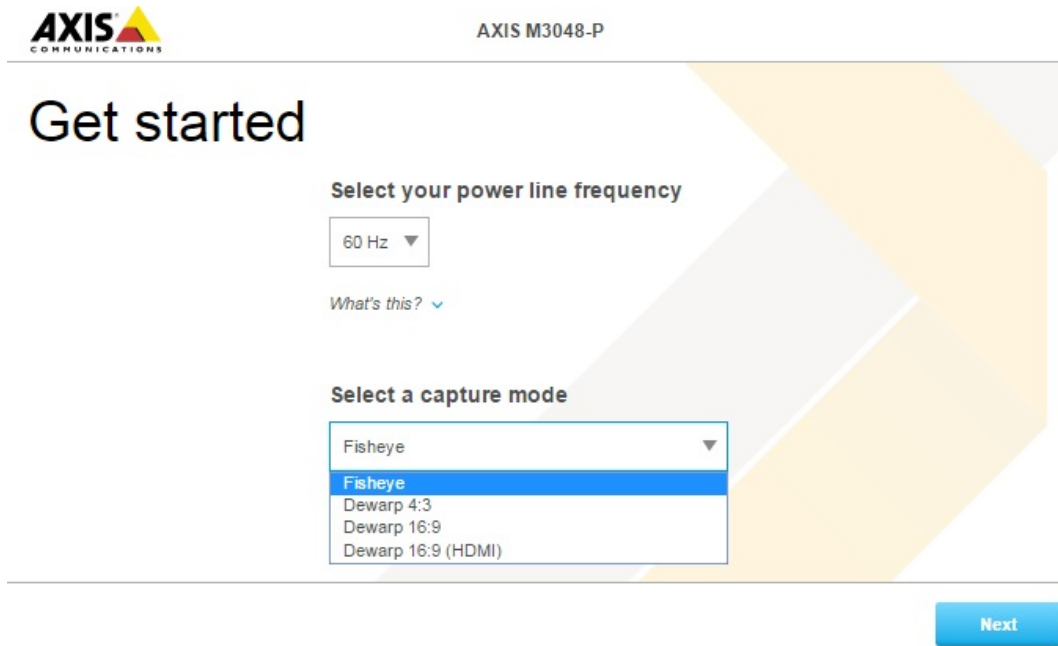

Select the power line frequency and capture mode. Please be aware of that the supported resolutions for dewarped views differ depending on the selected capture mode. Selecting the Fisheye mode, you will have access only to the full overview image via web interface and no other views.

Note

You should select the HDMI capture mode only when intend to connect a monitor to the HDMI output. The supported resolutions will be limited for this mode and for the HDMI output source, you can choose between the overview and the selected dewarped view.

AXIS M30-P Network Camera Series

Quick start guide

AXIS COMMUNICATIONS

AXIS M3048-P Network Camera

Get started

IPv4

Automatic IP (DHCP) and DNS (DHCP) ▼

Date and time

Automatic date and time

Year: 2017, Month: 05, Day: 16

Hour: 08, Min: 42

Connect to NTP-server

Automatically (DHCP)

Manually

Time zone

GMT (Dublin, Lisbon, London, Reykjavik) ▼

Daylight saving time adjustment

Next

In the next step, set the IP settings and date/time.

AXIS COMMUNICATIONS

AXIS M3048-P

View Area 1&2

Perspective

Dewarped view

View Areas 1&2 ▼

The view or family of views you select here becomes the preset in the list of available streams. Besides this view, you'll be able to select the overview.

Done

Continue and select the perspective/orientation depending on how the camera is installed. In this step, you will select the preferred dewarped view as well (not for Fisheye mode).

In the wall mount mode, some views are not available due to that they don't fit in this mount option. See the table below for the available views in different perspective/orientation modes.

AXIS M30-P Network Camera Series

Quick start guide

View \ Perspective	Ceiling	Wall	Desktop
Overview	X	X	X
Panorama	X	X	X
Double Panorama	X	-	X
Quad	X	-	X
View Areas 1&2	X	X	X
Corner Left	X	-	X
Corner Right	X	-	X
Double Corner	X	-	X
Corridor	X	X	X

Selecting the Fisheye, you will have access to only full overview image where the highest resolution is 2048x2048 for AXIS M3047-P and 2880x2880 for AXIS M3048-P. In the next table you can also see the highest/lowest available resolution for different views in each capture mode for AXIS M3047-P and AXIS M3048-P.

View \ Capture mode	Dewarp 4:3	Dewarp 16:9	Dewarp 16:9 (HDMI)	Dewarp 16:9 25/30 fps, M3047-P only
Overview	1920x1920/2048x2048 480x480	1920x1920/2048x2048 480x480	1920x1920/2048x2048 480x480	1200x1200/480x480
Panorama	1920x720/2304x864 640x240	2304x648/2560x720 1280x360	2304x648/2560x720	2048x576/1280x360
Double Panorama	1920x1440/2304x1728 480x360	2304x1296/2560x1440 640x360	2304x1296/2560x1440 640x360	2048x1152/640x360
Quad	1920x1440/2304x1728 480x360	2304x1296/2560x1440 640x360	2304x1296/2560x1440 640x360	2048x1152/640x360
View Areas 1&2	1920x1440/1920x1440 480x360	1920x1080/2048x1152 640x360	1920x1080/2048x1152 640x360	1280x720/640x360
Corner Left	1920x720/1728x864 640x240/1440x720	1728x648/1920x720 640x240	1728x648/1920x720 640x240	1728x648/640x240
Corner Right	1920x720/1728x864 640x240/1440x720	1728x648/1920x720 640x240	1728x648/1920x720 640x240	1728x648/640x240
Double Corner	1920x1440/1728x1728 480x360/480x480	1728x1296/1920x1440 480x360	1728x1296/1920x1440 480x360	1728x1296/480x360
Corridor	1920x1440/1728x1728 480x360/480x480	2304x1296/2560x1440 640x360	2304x1296/2560x1440 640x360	2048x1152/640x360

Please note that the most of lowest values are the same for both AXIS M3047-P and AXIS M3048-P.

When you have selected the desired perspective and dewarped view, click **Done**.

AXIS M30-P Network Camera Series

Quick start guide

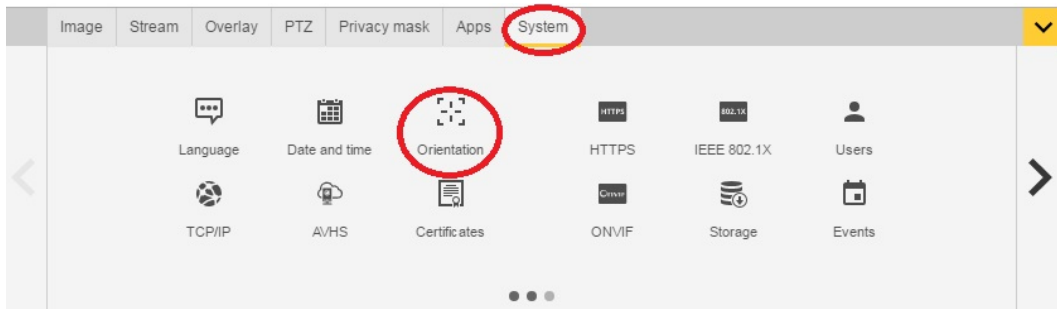

After the setup is completed, it is still possible to change the configurations in the camera's web pages. To change the dewarped view or perspective mode, go to **System > Orientation**.

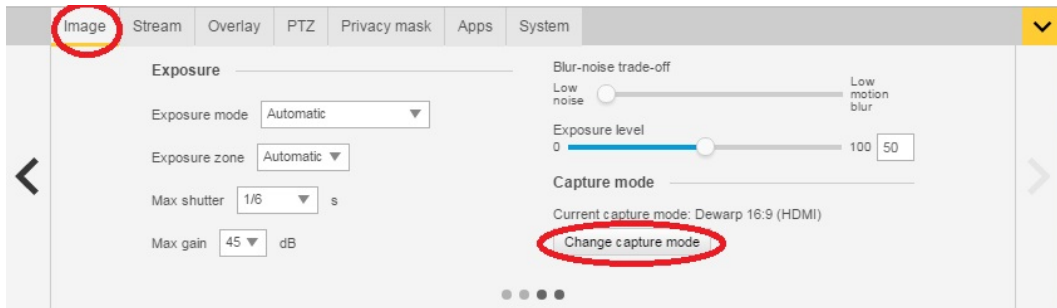

To change capture mode, go to **Settings > Image > Capture mode**. Click **Change capture mode**.

Important

When changing the capture mode, the boundaries of the video image will be changed. It also resets other image settings, such as:

- Exposure zones
- Guard tours
- Image overlays
- Motion detection windows
- Preset positions
- Privacy masks
- View areas

To change/adjust the view areas

1. Go to **Settings > Image > Capture mode**.
2. Select **dewarp 16:9** or **4:3** capture mode.
3. Select **View Areas 1&t2** in the orientation option.
4. Go to **Settings > PTZ**.
5. In your video stream, click on the pointer in the middle of the circle.
6. Hold the mouse button and drag the pointer around to find your desired view area.

AXIS M30-P Network Camera Series

Quick start guide

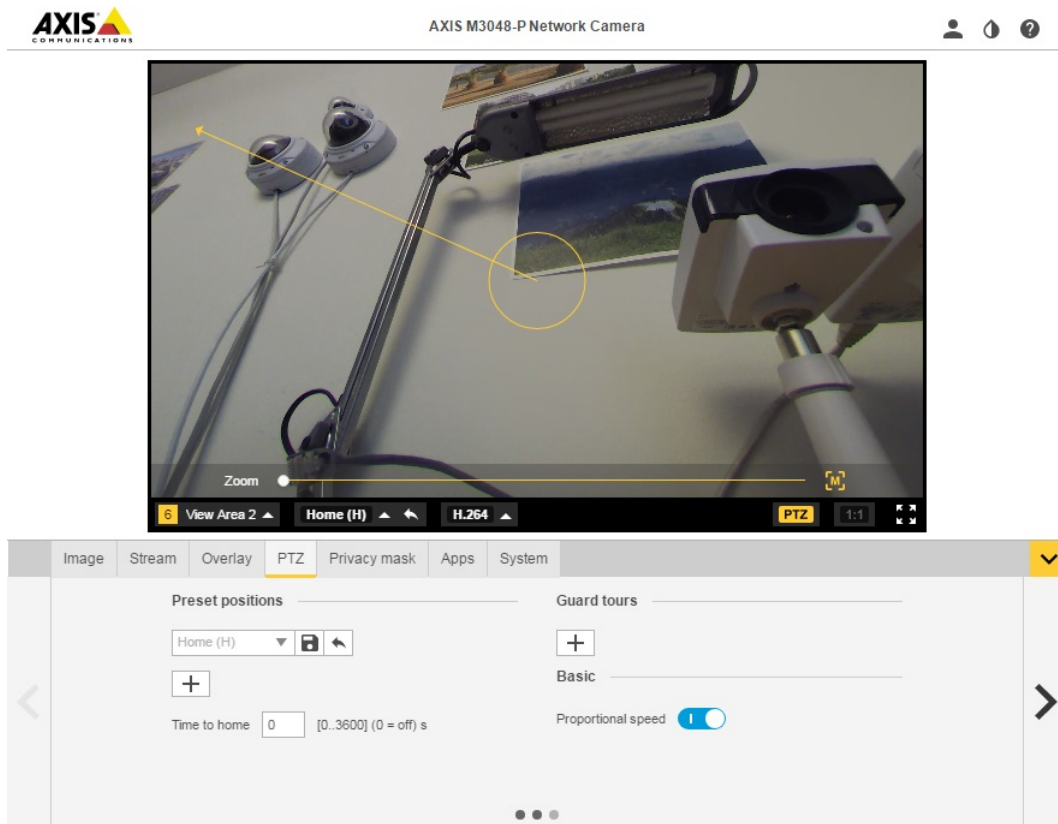

You might create several preset positions and do the above steps for each position.

Set up multiple video streams

The tables shows different possible video streams which can be pulled simultaneously from AXIS M3047-P and AXIS M3048-P.

Fisheye

		AXIS M3047-P	AXIS M3048-P		
Stream	View	Resolution	Resolution	FPS	Codec
s1	fisheye	2048x2048	2880x2880	25/30	h264 or mjpeg
s2	fisheye	<=2048x2048	<=2048x2048	25/30	h264 or mjpeg
s3	fisheye	<=720x720	<=720x720	25/30	h264 and mjpeg
s4	fisheye	<=720x720	<=720x720	25/30	h264 and mjpeg

Dewarp 4:3

		AXIS M3047-P	AXIS M3048-P		
Stream	View	Resolution	Resolution	FPS	Codec
s1	fisheye	1920x1920	2048x2048	12.5/15	h264 or mjpeg

AXIS M30-P Network Camera Series

Quick start guide

s2	dewarp	max dewarp resolution	max dewarp resolution	12.5/15	h264 or mjpeg
s3	fisheye	<=1920x1920	<=1920x1920	12.5/15	h264 or mjpeg
s3	dewarp	<=1920x1440	<=1920x1440	12.5/15	h264 or mjpeg
s4	fisheye	<=720x720	<=720x720	12.5/15	h264 and mjpeg
s4	dewarp	w<=720 h<=720	w<=720 h<=720	12.5/15	h264 and mjpeg

Dewarp 16:9

		AXIS M3047-P	AXIS M3048-P		
Stream	View	Resolution	Resolution	FPS	Codec
s1	fisheye	1920x1920	2048x2048	12.5/15	h264 or mjpeg
s2	dewarp	max dewarp resolution	max dewarp resolution	12.5/15	h264 or mjpeg
s3	fisheye	<=1920x1920	<=1920x1920	12.5/15	h264 or mjpeg
s3	dewarp	<=1920x1080	<=1920x1440	12.5/15	h264 or mjpeg
s4	fisheye	<=720x720	<=720x720	12.5/15	h264 and mjpeg
s4	dewarp	w<=720 h<=720	w<=720 h<=720	12.5/15	h264 and mjpeg

Dewarp 16:9 HDMI

		AXIS M3047-P	AXIS M3048-P		
Stream	View	Resolution	Resolution	FPS	Codec
s1	fisheye	1920x1920	2048x2048	12.5/15	h264 or mjpeg
s2	dewarp	max dewarp resolution	max dewarp resolution	12.5/15	h264 or mjpeg
s3	HDMI output fisheye	720p	720p	N/A	N/A
s3	HDMI output dewarp	720p	720p	N/A	N/A
s4	fisheye	<=720x720	<=720x720	12.5/15	h264 and mjpeg
s4	dewarp	w<=720 h<=720	w<=720 h<=720	12.5/15	h264 and mjpeg, 32:9 resolutions not available

(AXIS M3047-P only) - Dewarp 16:9@30fps

		AXIS M3047-P			
Stream	View	Resolution		FPS	Codec
s1	fisheye	1200x1200		25/30	h264 or mjpeg
s2	dewarp	max dewarp resolution		25/30	h264 or mjpeg
s3	fisheye	<=1200x1200		25/30	h264 or mjpeg
s3	dewarp	<= 1920x1296		25/30	h264 or mjpeg

AXIS M30-P Network Camera Series

Quick start guide

s4	fisheye	<=720x720		25/30	h264 and mjpeg
s4	dewarp	w<=720 h<=720		25/30	h264 and mjpeg

HDMI Supported output formats

- 720x480p @ 59.94/60Hz
- 1280x720p @ 59.94/60Hz
- 720x576p @ 50Hz
- 1280x720p @ 50Hz

AXIS M30-P Network Camera Series

Setup

Setup

How to access the product

AXIS IP Utility and AXIS Camera Management are recommended methods for finding Axis products on the network and assigning them IP addresses in Windows®. Both applications are free and can be downloaded from axis.com/support

The product can be used with the following browsers:

- Windows®: Chrome™ (recommended), Firefox®, Edge®, or Opera®
- OS X®: Chrome™ (recommended) or Safari®
- Other operating systems: Chrome™ or Firefox®.

If you need more information about recommended browsers, go to axis.com/browser-support

How to access the product from a browser

1. Start a web browser.
2. Enter the IP address or host name of the Axis product in the browser's address field.

To access the product from a Mac computer (OS X), go to Safari, click on Bonjour and select the product from the drop-down list. To add Bonjour as a browser bookmark, go to **Safari > Preferences**.

If you do not know the IP address, use AXIS IP Utility to locate the product on the network. For information about how to discover and assign an IP address, see the document *Assign an IP Address and Access the Video Stream* on Axis Support web at axis.com/support

3. Enter your username and password. If this is the first time the product is accessed, the root password must first be configured.
4. The product's live view page opens in your browser.

About secure passwords

Important

Axis devices send the initially set password in clear text over the network. To protect your device after the first login, set up a secure and encrypted HTTPS connection and then change the password.

The device password is the primary protection for the data and services. Axis devices do not impose a password policy as they may be used in various types of installations. To protect your data we recommend that you:

- Change the default password that comes with the devices.
- Use a password with at least 8 characters, preferably created by a password generator.
- Don't expose the password.
- Change password at a recurring interval, at least once a year.

Set a secure password for the root account

Important

The default administrator user name **root** cannot be deleted. If the password for root is lost, the device must be reset to the factory default settings.

1. Make sure to follow the instructions about secure passwords. See *About secure passwords* on page 12.

AXIS M30-P Network Camera Series

Setup

2. Type a password and then retype it to confirm the spelling.
3. Click Create login. The password has now been configured.

About the product's built-in help

You can access the built-in help through your product's webpage. The help provides more detailed information on the product's features and their settings.

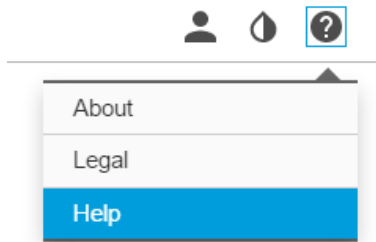

About capture modes

A capture mode is one of the possible views for this product and can be accessed from the drop-down list in the product's live stream view.

In the table you can see the highest and lowest available resolution for different views in each capture mode.

AXIS M3047-P

View \ Capture mode	Dewarp 4:3	Dewarp 16:9	Dewarp 16:9 (HDMI)	Dewarp 16:9 25/30 fps, M3047-P only
Overview	1920x1920 480x480	1920x1920 480x480	1920x1920 480x480	1200x1200 480x480
Panorama	1920x720 640x240	2304x648 1280x360	2304x648 -	2048x576 1280x360
Double Panorama	1920x1440 480x360	2304x1296 640x360	2304x1296 640x360	2048x1152 640x360
Quad	1920x1440 480x360	2304x1296 640x360	2304x1296 640x360	2048x1152 640x360
View Areas 1&2	1920x1440 480x360	1920x1080 640x360	1920x1080 640x360	1280x720 640x360
Corner Left	1920x720 640x240	1728x648 640x240	1728x648 640x240	1728x648 640x240
Corner Right	1920x720 640x240	1728x648 640x240	1728x648 640x240	1728x648 640x240
Double Corner	1920x1440 480x360	1728x1296 480x360	1728x1296 480x360	1728x1296 480x360
Corridor	1920x1440 480x360	2304x1296 640x360	2304x1296 640x360	2048x1152 640x360

AXIS M30-P Network Camera Series

Setup

AXIS M3048-P

View \ Capture mode	Dewarp 4:3	Dewarp 16:9	Dewarp 16:9 (HDMI)
Overview	2048x2048 480x480	2048x2048 480x480	2048x2048 480x480
Panorama	2304x864 640x240	2560x720 1280x360	2560x720 -
Double Panorama	2304x1728 480x360	2560x1440 640x360	2560x1440 640x360
Quad	2304x1728 480x360	2560x1440 640x360	2560x1440 640x360
View Areas 1&2	1920x1440 480x360	2048x1152 640x360	2048x1152 640x360
Corner Left	1728x864 1440x720	1920x720 640x240	1920x720 640x240
Corner Right	1728x864 1440x720	1920x720 640x240	1920x720 640x240
Double Corner	1728x1728 480x480	1920x1440 480x360	1920x1440 480x360
Corridor	1728x1728 480x480	2560x1440 640x360	2560x1440 640x360

How to select capture mode

Which capture mode to choose depends on the requirements of frame rate and resolution for the specific surveillance setup. For specifications about available capture modes, see the product's datasheet. To find the latest version of the datasheet, go to axis.com

How to choose video compression format

Decide which compression method to use based on your viewing requirements, and on the properties of your network. The available options are:

Motion JPEG

Motion JPEG or MJPEG is a digital video sequence that is made up of a series of individual JPEG images. These images are then displayed and updated at a rate sufficient to create a stream that shows constantly updated motion. For the viewer to perceive motion video the rate must be at least 16 image frames per second. Full motion video is perceived at 30 (NTSC) or 25 (PAL) frames per second.

The Motion JPEG stream uses considerable amounts of bandwidth, but provides excellent image quality and access to every image contained in the stream.

H.264 or MPEG-4 Part 10/AVC

Note

H.264 is a licensed technology. The Axis product includes one H.264 viewing client license. Installing additional unlicensed copies of the client is prohibited. To purchase additional licenses, contact your Axis reseller.

H.264 can, without compromising image quality, reduce the size of a digital video file by more than 80% compared to the Motion JPEG format and by as much as 50% compared to the MPEG-4 standard. This means that less network bandwidth and storage space are required for a video file. Or seen another way, higher video quality can be achieved for a given bitrate.

AXIS M30-P Network Camera Series

Setup

How to reduce bandwidth and storage

Important

If you reduce the bandwidth it can result in loss of details in the picture.

1. Go to live view and select **H.264**.
2. Go to **Settings > Stream**.
3. Do one or more of the following:
 - Turn on the Zipstream functionality and select the desired level.
 - Turn on dynamic GOP and set a high GOP length value.
 - Increase the compression.
 - Turn on dynamic FPS.

How to reduce noise in low-light conditions

To reduce noise in low-light conditions, you can adjust one or more of the following settings:

- Make sure that the exposure mode is automatic.

Note

Increasing the max shutter value can result in motion blur.

- The shutter speed should be as slow as possible, which means you should set max shutter to the highest possible value.
- Reduce sharpness in the image.

How to select exposure mode

There are different exposure mode options in the camera that adjusts aperture, shutter speed, and gain to improve image quality for specific surveillance scenes. Go to **Settings > Image > Exposure** and select between the following exposure modes:

- For most use cases, select **Automatic** exposure.
- For environments with certain artificial lighting, for example fluorescent lighting, select **Flicker-free**.
Select the same frequency as the power line frequency.
- For environments with certain artificial light and bright light, for example outdoors with fluorescent lighting at night and sun during daytime, select **Flicker-reduced**.
Select the same frequency as the power line frequency.
- To lock the current exposure settings, select **Hold current**.

How to set up a monitor

The product can be connected to a HDMI display and transmit video to that display without the need for a network connection. The display can either be used for surveillance or as a public view monitor e.g. in a store.

1. Connect an external monitor using the HDMI connector.
2. Confirm capture mode **Dewarp 16:9 (HDMI)** is selected.
3. Change the HDMI settings under **System > HDMI**. For more information about HDMI settings, please see the online help 

AXIS M30-P Network Camera Series

Setup

How to trigger an action

1. Go to **Settings > System > Events** to set up an action rule. The action rule defines when the camera will perform certain actions. Action rules can be setup as scheduled, recurring, or for example, triggered by motion detection.
2. Select what **Trigger** must be met to trigger the action. If you specify more than one trigger for the action rule, all of them must be met to trigger the action.
3. Select which **Action** the camera should perform when the conditions are met.

Note

If you make changes to an active action rule, the action rule needs to be restarted for the changes to take effect.

About overlays

Note

Image and text overlay will not be displayed on video stream over HDMI.

Overlays are superimposed over the video stream. They are used to provide extra information during recordings, such as a timestamp, or during product installation and configuration.

About applications

AXIS Camera Application Platform (ACAP) is an open platform that enables third parties to develop analytics and other applications for Axis products. To find out more about available applications, downloads, trials and licenses, go to axis.com/applications

To find the user manuals for Axis applications, go to axis.com

Note

- Several applications can run at the same time but some applications might not be compatible with each other. Certain combinations of applications might require too much processing power or memory resources when run in parallel. Verify that the applications work together before deployment.

AXIS M30-P Network Camera Series

Troubleshooting

Troubleshooting

How to reset to factory default settings

Important

Reset to factory default should be used with caution. A reset to factory default resets all settings, including the IP address, to the factory default values.

To reset the product to the factory default settings:

1. Disconnect power from the product.
2. Press and hold the control button while reconnecting power. See *Product overview on page 4*.
3. Keep the control button pressed for 15–30 seconds until the status LED indicator flashes amber.
4. Release the control button. The process is complete when the status LED indicator turns green. The product has been reset to the factory default settings. If no DHCP server is available on the network, the default IP address is 192.168.0.90
5. Use the installation and management software tools to assign an IP address, set the password, and access the video stream.

The installation and management software tools are available from the support pages on axis.com/support

It is also possible to reset parameters to factory default via the web interface. Go to **Settings > System > Maintenance** and click **Default**.

How to check the current firmware

Firmware is the software that determines the functionality of network devices. One of your first actions when troubleshooting a problem should be to check the current firmware version. The latest version may contain a correction that fixes your particular problem.

To check the current firmware:

1. Go to the product's webpage.
2. Click on the help menu. 
3. Click **About**.

How to upgrade the firmware

Important

Preconfigured and customized settings are saved when the firmware is upgraded (provided that the features are available in the new firmware) although this is not guaranteed by Axis Communications AB.

Important

Make sure the product remains connected to the power source throughout the upgrade process.

Note

When you upgrade the product with the latest firmware, the product receives the latest functionality available. Always read the upgrade instructions and release notes available with each new release before upgrading the firmware. To find the latest firmware and the release notes, go to axis.com/support/firmware

1. Download the latest firmware file to your computer, available free of charge at axis.com/support/firmware

AXIS M30-P Network Camera Series

Troubleshooting

2. Log in to the product as an administrator.
3. Go to **Settings > System > Maintenance** in the product's webpage and follow the instructions. When the upgrade has finished, the product restarts automatically.

AXIS Camera Management can be used for multiple upgrades. Find out more at axis.com/products/axis-camera-management

Technical issues, clues and solutions

If you can't find what you're looking for here, try the troubleshooting section at axis.com/support

Problems upgrading the firmware

Firmware upgrade failure	If the firmware upgrade fails, the product reloads the previous firmware. The most common reason is that the wrong firmware file has been uploaded. Check that the name of the firmware file corresponds to your product and try again.
--------------------------	---

Problems setting the IP address

The product is located on a different subnet	If the IP address intended for the product and the IP address of the computer used to access the product are located on different subnets, you cannot set the IP address. Contact your network administrator to obtain an IP address.
--	---

The IP address is being used by another device	Disconnect the Axis product from the network. Run the ping command (in a Command/DOS window, type <code>ping</code> and the IP address of the product): <ul style="list-style-type: none">• If you receive: <code>Reply from <IP address>: bytes=32; time=10...</code> this means that the IP address may already be in use by another device on the network. Obtain a new IP address from the network administrator and reinstall the product.• If you receive: <code>Request timed out</code>, this means that the IP address is available for use with the Axis product. Check all cabling and reinstall the product.
--	---

Possible IP address conflict with another device on the same subnet	The static IP address in the Axis product is used before the DHCP server sets a dynamic address. This means that if the same default static IP address is also used by another device, there may be problems accessing the product.
---	---

The product cannot be accessed from a browser

Cannot log in	When HTTPS is enabled, ensure that the correct protocol (HTTP or HTTPS) is used when attempting to log in. You may need to manually type <code>http</code> or <code>https</code> in the browser's address field.
---------------	--

If the password for the user `root` is lost, the product must be reset to the factory default settings. See *How to reset to factory default settings* on page 17.

The IP address has been changed by DHCP	IP addresses obtained from a DHCP server are dynamic and may change. If the IP address has been changed, use AXIS IP Utility or AXIS Camera Management to locate the product on the network. Identify the product using its model or serial number, or by the DNS name (if the name has been configured).
---	---

If required, a static IP address can be assigned manually. For instructions, go to axis.com/support

Certificate error when using IEEE 802.1X	For authentication to work properly, the date and time settings in the Axis product must be synchronized with an NTP server. Go to Settings > System > Date and time
--	---

The product is accessible locally but not externally

Router configuration	Check that your router allows incoming data traffic to the Axis product. The router must support UPnP®.
----------------------	---

Firewall protection	Check the Internet firewall with your network administrator.
---------------------	--

AXIS M30-P Network Camera Series

Troubleshooting

Problems with streaming

Multicast H.264 only accessible by local clients	Check if your router supports multicasting, or if the router settings between the client and the product need to be configured. The TTL (Time To Live) value may need to be increased.
No multicast H.264 displayed in the client	Check with your network administrator that the multicast addresses used by the Axis product are valid for your network. Check with your network administrator to see if there is a firewall preventing viewing.
Poor rendering of H.264 images	Ensure that your graphics card is using the latest driver. The latest drivers can usually be downloaded from the manufacturer's website.
Color saturation is different in H.264 and Motion JPEG	Modify the settings for your graphics adapter. Go to the adapter's documentation for more information.
Lower frame rate than expected	<ul style="list-style-type: none">• See <i>Performance considerations on page 19</i>.• Reduce the number of applications running on the client computer.• Limit the number of simultaneous viewers.• Check with the network administrator that there is enough bandwidth available.• Lower the image resolution.• The maximum frames per second is dependent on the utility frequency (60/50 Hz) of the Axis product.

Performance considerations

When setting up your system, it is important to consider how various settings and situations affect the performance. Some factors affect the amount of bandwidth (the bitrate) required, others can affect the frame rate, and some affect both. If the load on the CPU reaches its maximum, this also affects the frame rate.

The following factors are the most important to consider:

- High image resolution or lower compression levels result in images containing more data which in turn affects the bandwidth.
- Access by large numbers of Motion JPEG or unicast H.264 clients affects the bandwidth.
- Simultaneous viewing of different streams (resolution, compression) by different clients affects both frame rate and bandwidth.

Use identical streams wherever possible to maintain a high frame rate. Stream profiles can be used to ensure that streams are identical.

- Accessing Motion JPEG and H.264 video streams simultaneously affects both frame rate and bandwidth.
- Heavy usage of event settings affects the product's CPU load which in turn affects the frame rate.
- Using HTTPS may reduce frame rate, in particular if streaming Motion JPEG.
- Heavy network utilization due to poor infrastructure affects the bandwidth.
- Viewing on poorly performing client computers lowers perceived performance and affects frame rate.
- Running multiple AXIS Camera Application Platform (ACAP) applications simultaneously may affect the frame rate and the general performance.

AXIS M30-P Network Camera Series

Specifications

Specifications

To find the latest version of the product's datasheet, go to the product page on axis.com and locate **Support & Documentation**.

LED indicators

Note

- The Status LED can be configured to flash while an event is active.

Status LED	Indication
Unlit	Connection and normal operation.
Green	Shows steady green for 10 seconds for normal operation after startup completed.
Amber	Steady during startup. Flashes during firmware upgrade or reset to factory default.
Amber/Red	Flashes amber/red if network connection is unavailable or lost.
Red	Firmware upgrade failure.

SD card slot

NOTICE

- Risk of damage to SD card. Do not use sharp tools, metal objects, or excessive force when inserting or removing the SD card. Use your fingers to insert and remove the card.
- Risk of data loss and corrupted recordings. Do not remove the SD card while the product is running. Unmount the SD card from the product's webpage before removal.

This product supports microSD/microSDHC/microSDXC cards.

For SD card recommendations, see axis.com

Buttons

Control button

The control button is used for:

- Resetting the product to factory default settings. See *How to reset to factory default settings on page 17*.
- Connecting to an AXIS Video Hosting System service. To connect, press and hold the button for about 3 seconds until the status LED flashes green.

Connectors

HDMI connector

Use the HDMI™ connector to connect a display or public view monitor.

Network connector

RJ45 Ethernet connector with Power over Ethernet (PoE).

