

## **AXIS P1367 Network Camera**

## **User Manual**

# AXIS P1367 Network Camera

## Table of Contents

---

<b>System overview</b> .....	3
<b>Product overview</b> .....	4
<b>How to access the product</b> .....	5
How to access the product from a browser .....	5
About secure passwords .....	5
<b>Setup</b> .....	7
About the product's built-in help .....	7
How to replace the lens .....	7
How to hide parts of the image with privacy masks .....	7
How to reduce noise in low-light conditions .....	7
How to select exposure mode .....	8
How to maximize details in an image .....	8
How to monitor long and narrow areas .....	8
How to enhance facial recognition .....	9
About view area .....	9
How to handle scenes with strong backlight .....	10
About overlays .....	10
How to show a text overlay when the camera detects motion .....	10
How to choose video compression format .....	11
How to reduce bandwidth and storage .....	11
How to set up network storage .....	12
How to add audio to your recording .....	12
How to record and watch video .....	12
About events .....	12
How to trigger an action .....	12
How to record video when the camera detects motion .....	13
About applications .....	13
<b>Troubleshooting</b> .....	14
How to reset to factory default settings .....	14
How to check the current firmware .....	14
How to upgrade the firmware .....	14
Technical issues, clues and solutions .....	15
Performance considerations .....	16
<b>Specifications</b> .....	17
SD card slot .....	17
Buttons .....	17
Connectors .....	18
Operating conditions .....	19
Power consumption .....	19

# AXIS P1367 Network Camera

## System overview

---

### System overview

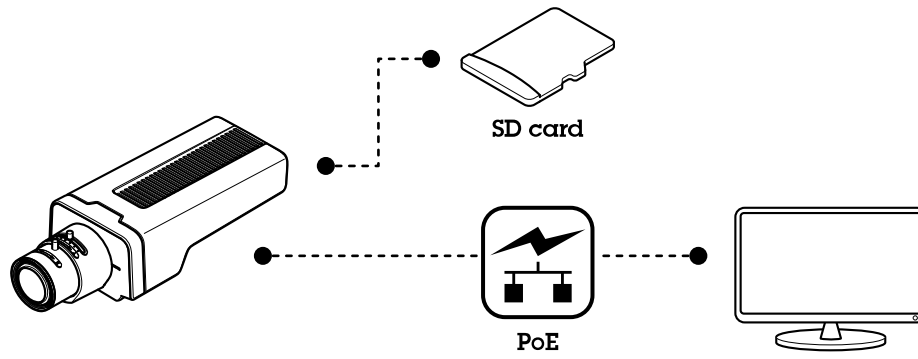

# AXIS P1367 Network Camera

## Product overview

---

### Product overview

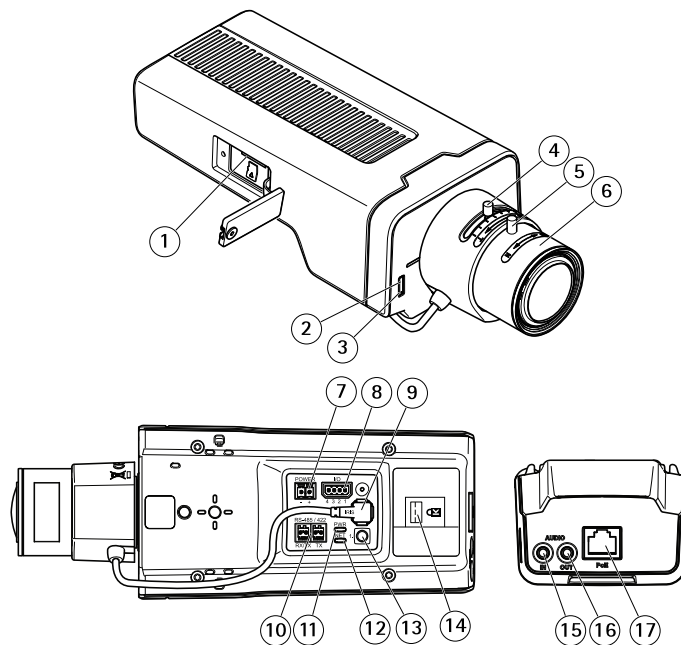

- 1 *microSD card slot*
- 2 *Status LED*
- 3 *Built-in microphone*
- 4 *Zoom puller*
- 5 *Lock screw for focus ring*
- 6 *Focus ring*
- 7 *Power connector (DC)*
- 8 *I/O connector*
- 9 *Iris connector*
- 10 *RS485/422 connector*
- 11 *Power LED*
- 12 *Network LED*
- 13 *Control button*
- 14 *Security slot*
- 15 *Audio in*
- 16 *Audio out*
- 17 *Network connector (PoE)*

# AXIS P1367 Network Camera

## How to access the product

---

### How to access the product

AXIS IP Utility and AXIS Camera Management are recommended methods for finding Axis products on the network and assigning them IP addresses in Windows®. Both applications are free and can be downloaded from [axis.com/support](https://axis.com/support)

The product can be used with the following browsers:

- Chrome™ (recommended), Firefox®, Edge®, or Opera® with Windows®
- Chrome™ (recommended) or Safari® with OS X®
- Chrome™ or Firefox® with other operating systems.

### How to access the product from a browser

1. Start a web browser.
2. Enter the IP address or host name of the Axis product in the browser's address field.

To access the product from a Mac computer (OS X), go to Safari, click on Bonjour and select the product from the drop-down list.

If you do not know the IP address, use AXIS IP Utility to locate the product on the network. For information about how to discover and assign an IP address, see the document *Assign an IP Address and Access the Video Stream* on Axis Support web at [axis.com/support](https://axis.com/support)

#### Note

To show Bonjour as a browser bookmark, go to **Safari > Preferences**.

3. Enter your username and password. If this is the first time the product is accessed, the root password must first be configured.
4. The product's live view page opens in your browser.

### About secure passwords

#### Important

When setting the initial password, the password is sent in clear text over the network. If there is a risk of network sniffing, first set up a secure and encrypted HTTPS connection before resetting the passwords.

The device password is the primary protection for the data and services. Axis' products do not impose a password policy as products may be used in various types of installations, but to protect your data do the following:

- Don't use the default password that comes with the products.
- Use a password with at least 8 characters, preferably using a password generator.
- Don't expose the password.
- Change password at a recurring interval, at least once a year.

### Set a password for the root account

#### Important

The default administrator user name **root** cannot be deleted. If the password for root is lost, the product must be reset to the factory default settings.

# AXIS P1367 Network Camera

## How to access the product

---

The default root account has full privileges and should be reserved for administrative tasks. Always create a user account with limited privileges for daily use. This reduces the exposure of the administrative account.

1. Make sure to follow the instructions about secure passwords, see *About secure passwords on page 5*.
2. Type a password and then retype it to confirm the spelling.
3. Click **Create login**. The password has now been configured.

# AXIS P1367 Network Camera

## Setup

---

### Setup

#### About the product's built-in help

You can access the built-in help through your product's web page. The help provides more detailed information on the product's features and their settings.

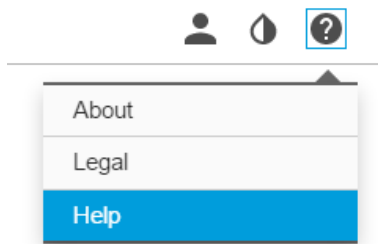

#### How to replace the lens

1. Stop all recordings and disconnect power from the product.
2. Disconnect the lens cable and remove the standard lens.
3. Attach the new lens and connect the lens cable.
4. Reconnect the power.
5. Go to the **Image** tab in the product's webpage and select the **P-Iris** lens you have installed.

##### Note

If you use a DC iris lens, select **Generic DC Iris**.

6. Adjust the zoom and focus.

#### How to hide parts of the image with privacy masks

If you want to hide parts of the image due to privacy reasons, use one or several privacy masks.

##### What is a privacy mask?

A privacy mask is a user-defined area that covers parts of the monitored area. Privacy masks appear as blocks of solid color and are applied on the video stream.

Privacy masks can not be bypassed through the VAPIX® application programming interface (API).

##### Important

If you add many privacy masks, this may affect the product's performance.

##### How to create a privacy mask

To create or edit a privacy mask, go to **Settings > Privacy mask**.

#### How to reduce noise in low-light conditions

To reduce noise in low-light conditions, you can adjust one or more of the following settings:

# AXIS P1367 Network Camera

## Setup

---

- Make sure that the exposure mode is automatic.

### Note

Increasing the max shutter value can result in motion blur.

- The shutter speed should be as slow as possible, which means you should set max shutter to the highest possible value.
- Reduce sharpness in the image.
- Try lowering the max gain value.

## How to select exposure mode

There are several exposure mode options in the camera that adjusts aperture, shutter speed, and gain to improve image quality for specific surveillance scenes. In the **Image** tab, select between the following options:

- For most use cases, select **Automatic** exposure.
- For environments with certain artificial lighting, for example fluorescent lighting, select **Flicker-free**.  
Select the same frequency as the power line frequency.
- For environments with certain artificial light and bright light, for example outdoors with fluorescent lighting at night and sun during daytime, select **Flicker-reduced**.  
Select the same frequency as the power line frequency.
- To lock the current exposure settings, select **Hold current**.

## How to maximize details in an image

### Important

If you maximize details in an image, bitrate increases and might lead to reduced frame rate.

- Make sure to select capture mode that has the highest resolution.
- Set compression as low as possible.
- Select MJPEG streaming.
- Turn off the Zipstream functionality.

## How to monitor long and narrow areas

Use corridor format to better utilize the full field of view in a long and narrow area, for example a staircase, hallway, road, or tunnel.



# AXIS P1367 Network Camera

## Setup

---

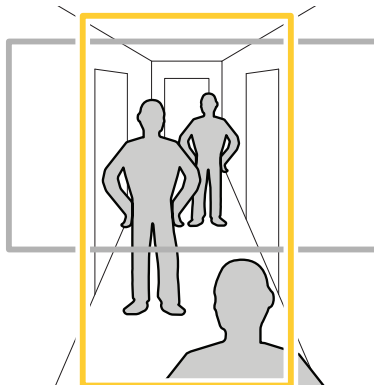

1. Depending on your product, turn the camera or the 3-axis lens in the camera 90° or 270°.
2. Go to **Settings > Stream > Orientation** on the product's webpage and rotate the view 90° or 270°.

Find out more at [axis.com/axis-corridor-format](http://axis.com/axis-corridor-format)

## How to enhance facial recognition

To better recognize the face of a person passing by the camera, you can set the optimal pixel resolution with the camera's pixel counter.

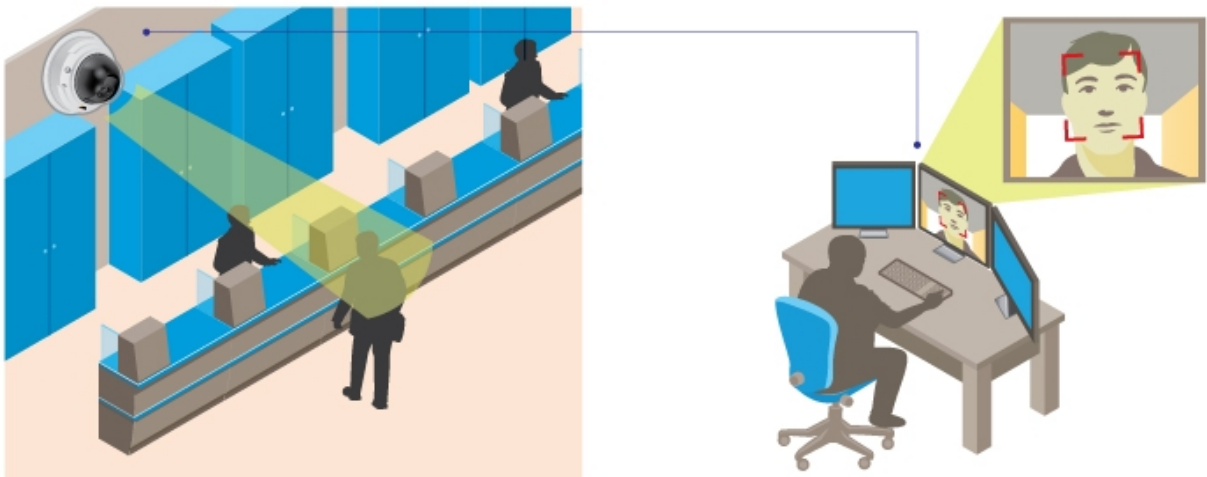

1. Draw a rectangle on the camera's live view around the area of interest, e.g. where the faces of passing persons are expected to appear. The camera then shows the number of pixels represented by the sides of the rectangle.
2. Adjust and move around the selected area as needed using drag and drop.

### Note

You can use an object of a known size in the view as a reference to decide how much resolution is needed for recognition.

## About view area

A view area is a cropped part of the full view. You can stream and store view areas instead of the full view to minimize bandwidth and storage needs. If you enable PTZ for a view area, you can pan, tilt and zoom within it. By using view areas you can remove parts of the full view, for example sky.

# AXIS P1367 Network Camera

## Setup

---

When you set up a view area, we recommend you to set the video stream resolution to the same size as or smaller than the view area size. If you set the video stream resolution larger than the view area size it implies digitally scaled up video after sensor capture, which requires more bandwidth without adding image information.

### How to handle scenes with strong backlight

Use WDR to make both dark and bright areas of the image visible.

1. Go to Settings > Image.
2. Turn on WDR under Wide dynamic range.



*Image without WDR.*



*Image with WDR.*

#### Note

If you use WDR, you may experience some WDR artifacts in the image.

Find out more about WDR and how to use it at [axis.com/web-articles/wdr](https://axis.com/web-articles/wdr)

### About overlays

Overlays are superimposed over the video stream. They are used to provide extra information during recordings, such as a timestamp, or during product installation and configuration.

### How to show a text overlay when the camera detects motion

This example explains how to display the text "Motion detected" when the camera detects motion:

1. Go to Settings > Overlay.

# AXIS P1367 Network Camera

## Setup

---

2. Enter #D in the text field.
3. Choose alignment, text size and appearance.
4. Include the text overlay.
5. Go to **System > Events > Action rules**.
6. Create an action rule with **AXIS Video Motion Detection** as trigger.
7. From the list of actions, select **Overlay text**.
8. Type "Motion detected".
9. Set the duration.

### How to choose video compression format

Deciding which compression method to choose depends on your viewing requirements, and on the properties of your network. The available options are:

#### Motion JPEG

Motion JPEG or MJPEG is a digital video sequence that is made up of a series of individual JPEG images. These images are then displayed and updated at a rate sufficient to create a stream that shows constantly updated motion. For the viewer to perceive motion video the rate must be at least 16 image frames per second. Full motion video is perceived at 30 (NTSC) or 25 (PAL) frames per second.

The Motion JPEG stream uses considerable amounts of bandwidth, but provides excellent image quality and access to every image contained in the stream.

#### H.264 or MPEG-4 Part 10/AVC

##### Note

H.264 is a licensed technology. The Axis product includes one H.264 viewing client license. Installing additional unlicensed copies of the client is prohibited. To purchase additional licenses, contact your Axis reseller.

H.264 can, without compromising image quality, reduce the size of a digital video file by more than 80% compared to the Motion JPEG format and by as much as 50% compared to the MPEG-4 standard. This means that less network bandwidth and storage space are required for a video file. Or seen another way, higher video quality can be achieved for a given bitrate.

Find out more at [axis.com/compression-formats](http://axis.com/compression-formats)

### How to reduce bandwidth and storage

##### Important

If you reduce the bandwidth it can result in less details in the picture.

1. Go to live view and select H.264.
2. Go to the **Stream** tab.
3. Do one or more of the following:
  - Turn on the Zipstream functionality and select the desired level.
  - Turn on the GOP and set a high GOP length value.
  - Increase the compression.
  - Turn on the dynamic FPS.

# AXIS P1367 Network Camera

## Setup

---

### How to set up network storage

To store recordings on the network, you need to set up network storage:

1. Go to **Settings > System > Storage**.
2. Click **Setup** under **Network storage**.
3. Enter the IP address of the host server.
4. Enter the name of the shared location on the host server.
5. Move the switch if the share requires a login, and enter username and password.
6. Click **Connect**.

### How to add audio to your recording

Edit the stream profile which is used for the recording:

1. Go to **Settings > System > Stream profiles**.
2. Select the stream profile to modify.
3. In the **Audio** tab, select the **Audio stream** checkbox and select **On** from the drop-down list.
4. Click **Ok**.

### How to record and watch video

To record video you must first set up network storage, see *How to set up network storage*, or have an SD card installed.

1. Go to the camera's live view.
2. Click on **Record** once to start recording and one more time to stop recording.

To watch your recording:

1. Click on **Storage > Go to recordings**.
2. Select your recording in the list and it will play automatically.

### About events

The event pages allow you to configure your product to perform actions when different events occur. For example, the product can start a recording or send an email notification when motion is detected. The set of conditions that defines how and when the action is triggered is called an action rule.

### How to trigger an action

1. Go to **Settings > System > Events** to set up an action rule. The action rule defines when the product will perform certain actions. Action rules can be setup as scheduled, recurring, or for example, triggered by motion detection.
2. Select what **Trigger** must be met to trigger the action. If you specify more than one trigger for the action rule, all of them must be met to trigger the action.
3. Select which **Action** the camera should perform when the conditions are met.

#### Note

If you make changes to an active action rule, the action rule needs to be restarted for the changes to take effect.

# AXIS P1367 Network Camera

## Setup

---

### How to record video when the camera detects motion

This example explains how to set up the camera to start recording to the SD card five seconds before it detects motion and to stop one minute after.

Make sure the AXIS Video Motion Detection application is running:

1. Go to **Settings > Apps > AXIS Video Motion Detection**.
2. Start the application if it is not already running.
3. Make sure you have set up the application according to your needs.

Create an action rule:

4. Go to **Settings > System > Events** and add an action rule.
5. Type a name for the action rule.
6. From the list of triggers, select **Applications** and then select **AXIS Video Motion Detection (VMD)**.
7. From the list of actions, select **Record video**.
8. Select an existing stream profile or create a new one.
9. Set the pre-trigger time to 5 seconds.
10. Set the post-trigger time to 60 seconds.
11. Select **SD card** from the list of storage options.
12. Click **Ok**.

### About applications

AXIS Camera Application Platform (ACAP) is an open platform that enables third parties to develop analytics and other applications for Axis products. To find out more about available applications, downloads, trials and licenses, go to [axis.com/applications](http://axis.com/applications)

To find the user manuals for Axis applications, go to [axis.com](http://axis.com)

#### Note

- It is recommended to run one application at a time.
- Avoid running applications when the built-in motion detection is active.

# AXIS P1367 Network Camera

## Troubleshooting

---

### Troubleshooting

#### How to reset to factory default settings

##### Important

Reset to factory default should be used with caution. A reset to factory default resets all settings, including the IP address, to the factory default values.

To reset the product to the factory default settings:

1. Disconnect power from the product.
2. Press and hold the control button while reconnecting power. See *Product overview*.
3. Keep the control button pressed for 15–30 seconds until the status LED indicator flashes amber.
4. Release the control button. The process is complete when the status LED indicator turns green. The product has been reset to the factory default settings. If no DHCP server is available on the network, the default IP address is 192.168.0.90
5. Use the installation and management software tools to assign an IP address, set the password, and access the video stream.  
The installation and management software tools are available from the support pages on [axis.com/support](https://axis.com/support)
6. Refocus the product.

#### How to check the current firmware

Firmware is the software that determines the functionality of network devices. One of your first actions when troubleshooting a problem should be to check the current firmware version. The latest version may contain a correction that fixes your particular problem.

To check the current firmware:

1. Go to the product's webpage.
2. Click on the help menu. 
3. Click **About**.

#### How to upgrade the firmware

##### Important

Preconfigured and customized settings are saved when the firmware is upgraded (provided that the features are available in the new firmware) although this is not guaranteed by Axis Communications AB.

##### Note

When you upgrade the product with the latest firmware, the product receives the latest functionality available. Always read the upgrade instructions and release notes available with each new release before upgrading the firmware. To find the latest firmware and the release notes, go to [axis.com/support/firmware](https://axis.com/support/firmware)

1. Download the latest firmware file to your computer, available free of charge at [axis.com/support/firmware](https://axis.com/support/firmware)
2. Log in to the product as an administrator.
3. Go to **Settings > System > Maintenance** in the product's webpage and follow the instructions.

# AXIS P1367 Network Camera

## Troubleshooting

---

4. The upgrade takes a while, don't break the power to the product. When the upgrade is finished, the product restarts automatically.

AXIS Camera Management can be used for multiple upgrades. Find out more at [axis.com/products/axis-camera-management](http://axis.com/products/axis-camera-management)

## Technical issues, clues and solutions

If you can't find what you're looking for here, try the troubleshooting section at [axis.com/support](http://axis.com/support)

### Problems upgrading the firmware

---

Firmware upgrade failure	If the firmware upgrade fails, the product reloads the previous firmware. The most common reason is that the wrong firmware file has been uploaded. Check that the name of the firmware file corresponds to your product and try again.
--------------------------	---

### Problems setting the IP address

---

The product is located on a different subnet	If the IP address intended for the product and the IP address of the computer used to access the product are located on different subnets, you cannot set the IP address. Contact your network administrator to obtain an IP address.
--	---

The IP address is being used by another device	Disconnect the Axis product from the network. Run the ping command (in a Command/DOS window, type <code>ping</code> and the IP address of the product): <ul style="list-style-type: none"><li>• If you receive: <code>Reply from &lt;IP address&gt;: bytes=32; time=10...</code> this means that the IP address may already be in use by another device on the network. Obtain a new IP address from the network administrator and reinstall the product.</li><li>• If you receive: <code>Request timed out</code>, this means that the IP address is available for use with the Axis product. Check all cabling and reinstall the product.</li></ul>
--	---

Possible IP address conflict with another device on the same subnet	The static IP address in the Axis product is used before the DHCP server sets a dynamic address. This means that if the same default static IP address is also used by another device, there may be problems accessing the product.
---	---

### The product cannot be accessed from a browser

---

Cannot log in	When HTTPS is enabled, ensure that the correct protocol (HTTP or HTTPS) is used when attempting to log in. You may need to manually type <code>http</code> or <code>https</code> in the browser's address field.  If the password for the user <code>root</code> is lost, the product must be reset to the factory default settings. See <i>How to reset to factory default settings</i> .
---------------	--

The IP address has been changed by DHCP	IP addresses obtained from a DHCP server are dynamic and may change. If the IP address has been changed, use AXIS IP Utility or AXIS Camera Management to locate the product on the network. Identify the product using its model or serial number, or by the DNS name (if the name has been configured).
---	---

If required, a static IP address can be assigned manually. For instructions, go to [axis.com/support](http://axis.com/support).

Certificate error when using IEEE 802.1X	For authentication to work properly, the date and time settings in the Axis product must be synchronized with an NTP server. Go to <b>Settings &gt; System &gt; Date and time</b>
--	---

### The product is accessible locally but not externally

---

Router configuration	Check that your router allows incoming data traffic to the Axis product. The router must support UPnP®.
----------------------	---

Firewall protection	Check the Internet firewall with your network administrator.
---------------------	--

# AXIS P1367 Network Camera

## Troubleshooting

---

### Problems with streaming

---

Multicast H.264 only accessible by local clients	Check if your router supports multicasting, or if the router settings between the client and the product need to be configured. The TTL (Time To Live) value may need to be increased.
No multicast H.264 displayed in the client	Check with your network administrator that the multicast addresses used by the Axis product are valid for your network.  Check with your network administrator to see if there is a firewall preventing viewing.
Poor rendering of H.264 images	Ensure that your graphics card is using the latest driver. The latest drivers can usually be downloaded from the manufacturer's website.
Color saturation is different in H.264 and Motion JPEG	Modify the settings for your graphics adapter. Go to the adapter's documentation for more information.
Lower frame rate than expected	<ul style="list-style-type: none"><li>• See <i>Performance considerations on page 16</i>.</li><li>• Reduce the number of applications running on the client computer.</li><li>• Limit the number of simultaneous viewers.</li><li>• Check with the network administrator that there is enough bandwidth available.</li><li>• Lower the image resolution.</li><li>• In the product's webpage, set a capture mode that prioritizes frame rate. Changing the capture mode to prioritize frame rate might lower the maximum resolution depending on the product used and capture modes available.</li><li>• The maximum frames per second is dependent on the utility frequency (60/50 Hz) of the Axis product.</li></ul>

### Performance considerations

When setting up your system, it is important to consider how various settings and situations affect the performance. Some factors affect the amount of bandwidth (the bitrate) required, others can affect the frame rate, and some affect both. If the load on the CPU reaches its maximum, this also affects the frame rate.

The following factors are the most important to consider:

- High image resolution or lower compression levels result in images containing more data which in turn affects the bandwidth.
- Access by large numbers of Motion JPEG or unicast H.264 clients affects the bandwidth.
- Simultaneous viewing of different streams (resolution, compression) by different clients affects both frame rate and bandwidth.

Use identical streams wherever possible to maintain a high frame rate. Stream profiles can be used to ensure that streams are identical.

- Accessing Motion JPEG and H.264 video streams simultaneously affects both frame rate and bandwidth.
- Heavy usage of event settings affects the product's CPU load which in turn affects the frame rate.
- Using HTTPS may reduce frame rate, in particular if streaming Motion JPEG.
- Heavy network utilization due to poor infrastructure affects the bandwidth.
- Viewing on poorly performing client computers lowers perceived performance and affects frame rate.
- Running multiple AXIS Camera Application Platform (ACAP) applications simultaneously may affect the frame rate and the general performance.



# AXIS P1367 Network Camera

## Specifications

---

### Specifications

To find the latest version of the product's datasheet, go to [axis.com](http://axis.com) > [product] > Support & Documentation.

#### LED Indicators

Status LED	Indication
Green	Steady green for normal operation.
Amber	Steady during startup. Flashes when restoring settings.

Network LED	Indication
Green	Steady for connection to a 100 Mbit/s network. Flashes for network activity.
Amber	Steady for connection to a 10 Mbit/s network. Flashes for network activity.
Unlit	No network connection.

Power LED	Indication
Green	Normal operation.
Amber	Flashes green/amber during firmware upgrade.

#### Status LED behavior for focus assistant

The status LED flashes when the Focus Assistant is active.

Color	Indication
Red	The image is out of focus. Adjust the lens.
Amber	The image is close to focus. The lens needs fine tuning.
Green	The image is in focus.

#### SD card slot

##### **NOTICE**

- Risk of damage to SD card. Do not use sharp tools, metal objects, or excessive force when inserting or removing the SD card. Use your fingers to insert and remove the card.
- Risk of data loss and corrupted recordings. Do not remove the SD card while the product is running. Unmount the SD card from the product's webpage before removal.

This product supports microSD/microSDHC/microSDXC cards (not included).

For SD card recommendations, see [axis.com](http://axis.com)

#### Buttons

##### Control button

The control button is used for:

# AXIS P1367 Network Camera

## Specifications

---

- Enabling the Focus Assistant. Press and very quickly release the Control button.
- Resetting the product to factory default settings. See *How to reset to factory default settings on page 14*.
- Connecting to an AXIS Video Hosting System service. To connect, press and hold the button for about 3 seconds until the status LED flashes green.

## Connectors

### Network connector

RJ45 Ethernet connector with Power over Ethernet (PoE).

### Audio connector

The Axis product has the following audio connectors:

- **Audio in (pink)** – 3.5 mm input for a mono microphone, or a line-in mono signal.
- **Audio out (green)** – 3.5 mm output for audio (line level) that can be connected to a public address (PA) system or an active speaker with a built-in amplifier. It is recommended to use a stereo connector for audio out.

For audio in, the left channel is used from a stereo signal.

3.5 mm audio connectors  
(stereo)

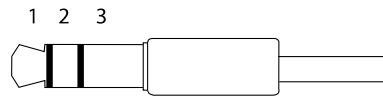

	1 Tip	2 Ring	3 Sleeve
Audio Input	Microphone/Line in	Microphone bias voltage	Ground
Audio Output	Line out, mono	Line out, mono	Ground

### I/O connectors

Use the I/O connector with external devices in combination with, for example, tampering alarms, motion detection, event triggering, and alarm notifications. In addition to the 0 V DC reference point and power (DC output), the I/O connector provides the interface to:

**Digital output** – For connecting external devices such as relays and LEDs. Connected devices can be activated by the VAPIX® Application Programming Interface or in the product's webpage.

**Digital input** – For connecting devices that can toggle between an open and closed circuit, for example PIR sensors, door/window contacts, and glass break detectors.

4-pin terminal block

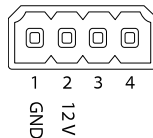

# AXIS P1367 Network Camera

## Specifications

### Power connector

2-pin terminal block for DC power input. Use a Safety Extra Low Voltage (SELV) compliant limited power source (LPS) with either a rated output power limited to  $\leq 100$  W or a rated output current limited to  $\leq 5$  A.

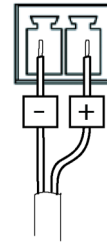

### RS485/RS422 connector

Two 2-pin terminal blocks for RS485/RS422 serial interface used to control auxiliary equipment such as pan-tilt devices.

The serial port can be configured to support:

- Two-wire RS485 half duplex
- Four-wire RS485 full duplex
- Two-wire RS422 simplex
- Four-wire RS422 full duplex point to point communication

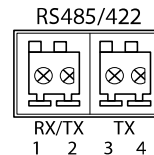

Function	Pin	Notes
RS485B alt RS485/422 RX(B)	1	RX pair for all modes (combined RX/TX for 2-wire RS485)
RS485A alt RS485/422 RX(A)	2	
RS485/RS422 TX(B)	3	TX pair for RS422 and 4-wire RS485
RS485/RS422 TX(A)	4	

#### Important

The maximum cable length is 30 m (98 ft).

### Operating conditions

The Axis product is intended for indoor use.

Product	Temperature	Humidity
AXIS P1367	0 °C to 50 °C (32 °F to 122 °F)	10–85% RH (non-condensing)

### Power consumption

#### NOTICE

Use a limited power source (LPS) with either a rated output power limited to  $\leq 100$ W or a rated output current limited to  $\leq 5$ A.

Product	Power over Ethernet (PoE) IEEE 802.3af/802.3at Type 1 Class 3	DC, 8–28 V DC
AXIS P1367	Max. 8.9 W Typical 5.0 W	Max. 8.8 W Typical 5.0 W

