

AXIS P32 Network Camera Series

AXIS P3235–LV Network Camera

AXIS P3235–LVE Network Camera

AXIS P32 Network Camera Series

Table of Contents

About this manual	3
Solution overview	4
.....	4
Product overview	5
.....	5
How to access the product	6
How to access the product from a browser	6
About secure passwords	6
Setup	8
Product webpage overview	8
Image quality	10
Privacy masks	14
Overlays	14
Streaming and storage	15
Events	16
Applications	20
Troubleshooting	21
How to reset to factory default settings	21
How to check the current firmware	21
How to upgrade the firmware	21
Technical issues, clues and solutions	22
Performance considerations	23
Specifications	25
LED indicators	25
SD card slot	25
Buttons	25
Connectors	26

AXIS P32 Network Camera Series

About this manual

About this manual

This user manual describes multiple products. Some of the instructions may not be relevant for your product.

AXIS P32 Network Camera Series

Solution overview

Solution overview

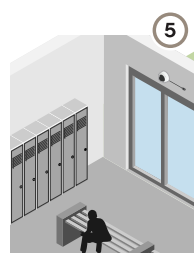
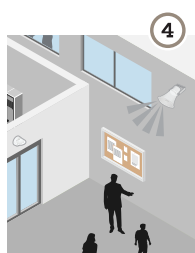
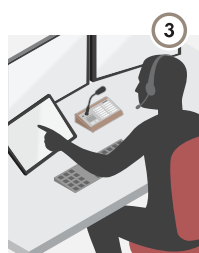
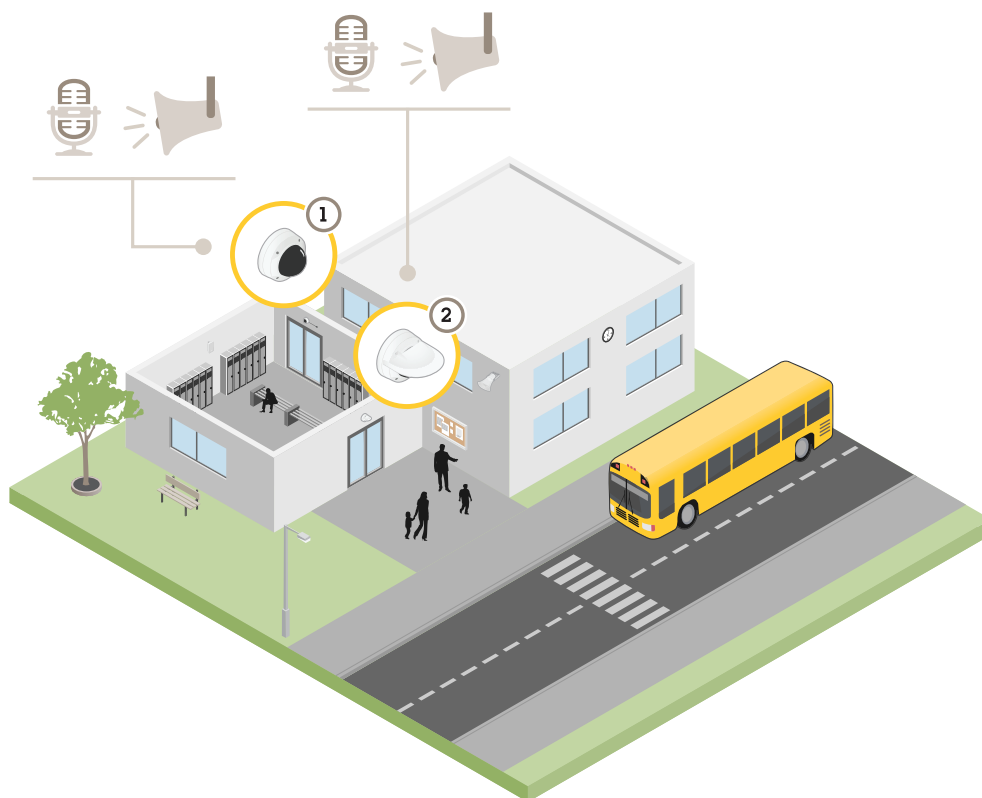

- 1 *AXIS P3235-LV*
- 2 *AXIS P3235-LVE*
- 3 *Surveillance center*
- 4 *Audio out*
- 5 *Audio in*

This is an example of how the products can be installed and used. The products can be connected to a speaker via audio out and a microphone via audio in, which makes it possible to watch, listen and broadcast information from the surveillance center.

AXIS P32 Network Camera Series

Product overview

Product overview

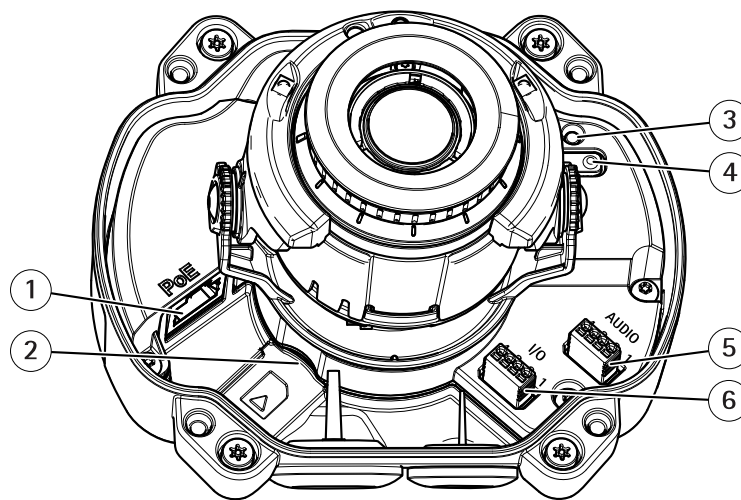

- 1 Network connector (PoE)
- 2 SD memory card slot
- 3 Status LED indicator
- 4 Control button
- 5 Audio
- 6 I/O

AXIS P32 Network Camera Series

How to access the product

How to access the product

AXIS IP Utility and AXIS Device Manager are recommended methods for finding Axis products on the network and assigning them IP addresses in Windows®. Both applications are free and can be downloaded from axis.com/support

The product can be used with the following browsers:

- Windows®: Chrome™ (recommended), Firefox®, Edge®, or Opera®
- OS X®: Chrome™ (recommended) or Safari®
- Other operating systems: Chrome™ or Firefox®.

If you need more information about recommended browsers, go to axis.com/browser-support

How to access the product from a browser

1. Start a web browser.
2. Enter the IP address or host name of the Axis product in the browser's address field.

To access the product from a Mac computer (OS X), go to Safari, click on Bonjour and select the product from the drop-down list. To add Bonjour as a browser bookmark, go to **Safari > Preferences**.

If you do not know the IP address, use AXIS IP Utility to locate the product on the network. For information about how to discover and assign an IP address, see the document *How to assign an IP address and access your device* on the product page at axis.com.

3. Enter your username and password. If this is the first time the product is accessed, the root password must first be configured.
4. The product's live view page opens in your browser.

About secure passwords

Important

Axis devices send the initially set password in clear text over the network. To protect your device after the first login, set up a secure and encrypted HTTPS connection and then change the password.

The device password is the primary protection for the data and services. Axis devices do not impose a password policy as they may be used in various types of installations. To protect your data we recommend that you:

- Change the default password that comes with each device.
- Use a password with at least 8 characters, preferably created by a password generator.
- Don't expose the password.
- Change the password at a recurring interval, at least once a year.

Set a secure password for the root account

Important

The default administrator username is **root**. If the password for root is lost, reset the device to factory default settings.

1. Type a password. Follow the instructions about secure passwords. See *About secure passwords* on page 6.
2. Retype the password to confirm the spelling.

AXIS P32 Network Camera Series

How to access the product

3. Click **Create login**. The password has now been configured.

AXIS P32 Network Camera Series

Setup

Setup

Product webpage overview



- 1 *Live view control bar*
- 2 *Live view*
- 3 *Product name*
- 4 *Controls*
- 5 *Video control bar*
- 6 *Settings toggle*

AXIS P32 Network Camera Series

Setup

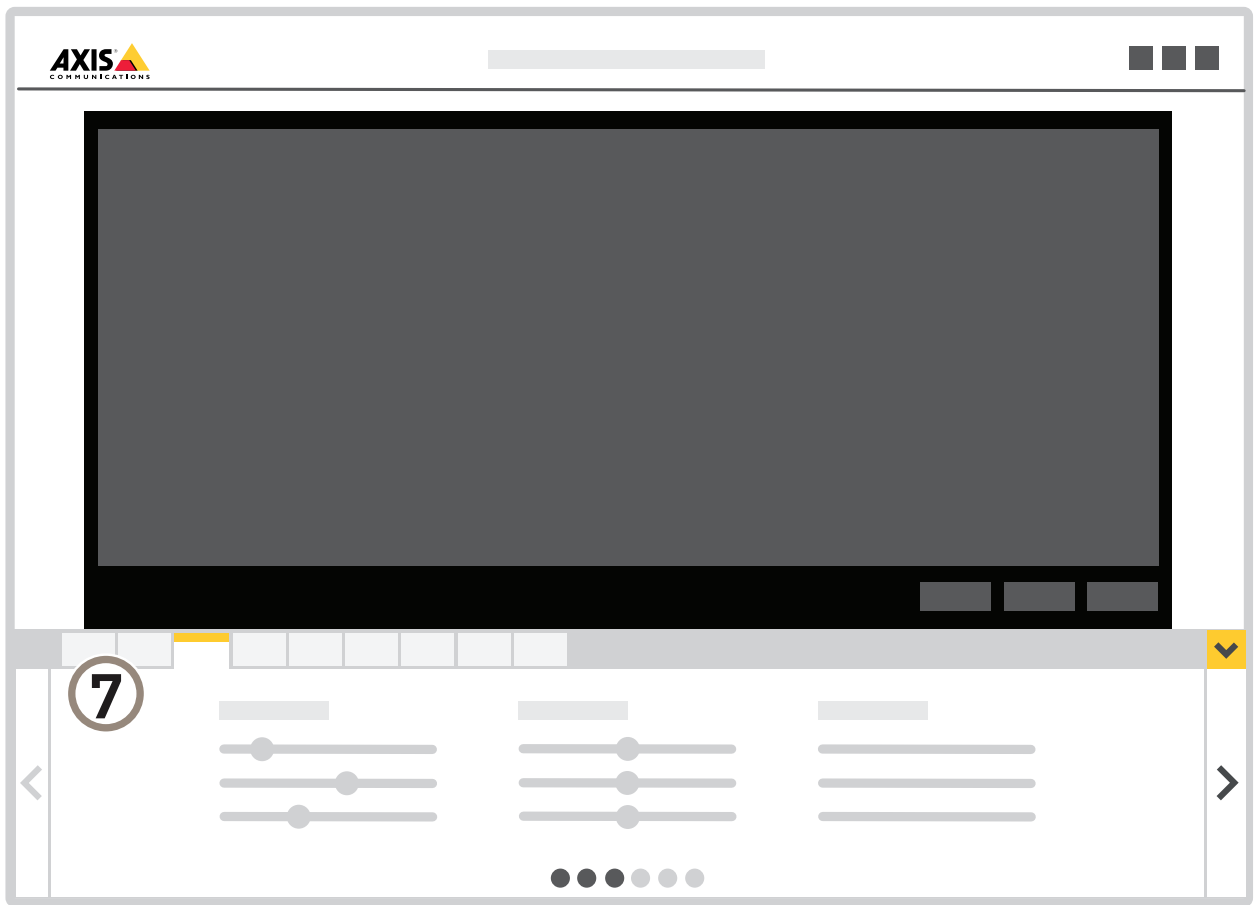

7 Settings tabs

About the product's built-in help

You can access the built-in help from the product's webpage. The help provides more detailed information on the product's features and their settings.

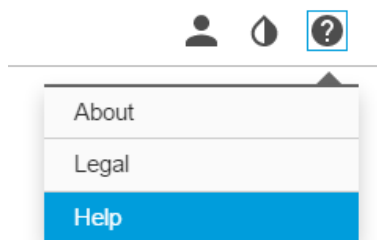

AXIS P32 Network Camera Series

Setup

Image quality

About capture modes

Capture mode defines the maximum frame rate available in the Axis product. Depending on which capture mode you select, you may not be able to use WDR.

A capture mode consists of a resolution and the corresponding frame rate available in the product. The capture mode setting affects the camera's field of view and aspect ratio.

The lower resolution capture mode is cropped out from the highest resolution.



The image shows how the field of view and aspect ratio can change between two different capture modes.

How to select capture mode

Which capture mode to choose depends on the requirements of frame rate and resolution for the specific surveillance setup. For specifications about available capture modes, see the product's datasheet. To find the latest version of the datasheet, go to axis.com

How to focus

1. Log in to the product's webpage and go to **Settings > Image > Focus**.
2. To set which area of the image that should be in focus, click **Show AF area**. If you don't select an autofocus area, the camera focuses on the entire scene.
3. Click **Autofocus**.
4. To fine tune the focus, use the focus slider.

About remote focus and zoom

The remote focus and zoom functionality allows you to make focus and zoom adjustments to your camera from a computer. It is a convenient way to ensure that the scene's focus, viewing angle and resolution are optimized without having to visit the camera's installation location.

AXIS P32 Network Camera Series

Setup



Left: no focus. Right: remote focus applied.



Left: no zoom. Right: remote zoom applied.

How to benefit from IR light in low-light conditions using night mode

Your camera uses visible light to deliver color images during the day. As light diminishes, you can set the camera to automatically shift to night mode. In night mode the camera uses both visible light and near-infrared light to deliver black-and-white images. Since the camera uses more of the available light it can deliver brighter, more detailed, images.

1. Go to **Settings > Image > Day and night**, and make sure that the **IR cut filter** is set to **Auto**.
2. Enable **Allow IR illumination** and **Synchronize IR illumination** to use the camera's built-in IR light when the night mode is activated.

How to reduce noise in low-light conditions

To reduce noise in low-light conditions, you can adjust one or more of the following settings:

Note

Increasing the max shutter value can result in motion blur.

- The shutter speed should be as slow as possible, which means you should set max shutter to the highest possible value.
- Reduce sharpness in the image.
- Try lowering the max gain value.

AXIS P32 Network Camera Series

Setup

How to handle scenes with strong backlight

Dynamic range is the difference in light levels in an image. In some cases the difference between the darkest and the brightest areas can be significant. The result is often an image where either the dark or the bright areas are visible. Wide dynamic range (WDR) makes both dark and bright areas of the image visible.

1. Go to **Settings > Image**.
2. Turn on WDR under **Wide dynamic range**.
3. Use the **Local contrast** slider to adjust the amount of WDR.



Image without WDR.



Image with WDR.

Note

WDR may cause artifacts in the image.

Find out more about WDR and how to use it at axis.com/web-articles/wdr

How to monitor long and narrow areas

Use corridor format to better utilize the full field of view in a long and narrow area, for example a staircase, hallway, road, or tunnel.

AXIS P32 Network Camera Series

Setup

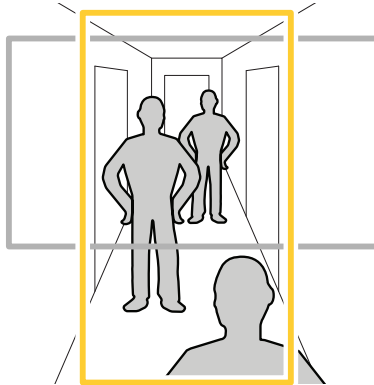



1. Depending on your product, turn the camera or the 3-axis lens in the camera 90° or 270°.
2. If your product doesn't rotate the view automatically, log in to the product's webpage and go to **Settings > Stream > Orientation**. Rotate the view 90° or 270°.

Find out more at axis.com/axis-corridor-format

How to enhance facial recognition

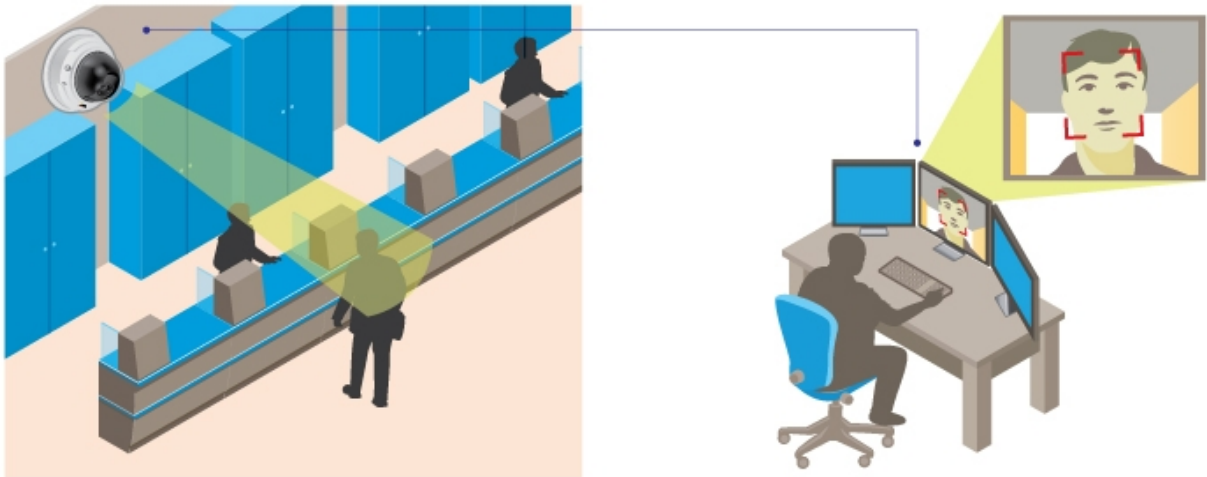
To better recognize the face of a person passing by the camera, you can set the optimal pixel resolution with the camera's pixel counter.



1. Go to **Settings > System > Orientation** and click .
2. Adjust the size and placement of the rectangle in the camera's live view around the area of interest, for example where the faces of passing persons are expected to appear. You can then see the number of pixels represented by the sides of the rectangle.

Note

You can use an object of a known size in the view as a reference to decide how much resolution is needed for recognition.

AXIS P32 Network Camera Series

Setup

About view area

A view area is a cropped part of the full view. You can stream and store view areas instead of the full view to minimize bandwidth and storage needs. If you enable PTZ for a view area, you can pan, tilt and zoom within it. By using view areas you can remove parts of the full view, for example, the sky.

When you set up a view area, we recommend you to set the video stream resolution to the same size as or smaller than the view area size. If you set the video stream resolution larger than the view area size it implies digitally scaled up video after sensor capture, which requires more bandwidth without adding image information.

Privacy masks

How to hide parts of the image with privacy masks

What is a privacy mask?

A privacy mask is a user-defined area that prevents users from viewing a part of the monitored area. In the video stream, privacy masks appear as blocks of solid color or blurred image elements.

You'll see the privacy mask on all snapshots, recorded video, and live streams.

You can use the VAPIX® application programming interface (API) to turn off the privacy masks.

Important

Using multiple privacy masks may affect the product's performance.

How to create a privacy mask

To create a privacy mask, go to **Settings > Privacy mask**.

Overlays

About overlays

Overlays are superimposed over the video stream. They are used to provide extra information during recordings, such as a timestamp, or during product installation and configuration.

How to show a text overlay when the camera detects motion

This example explains how to display the text "Motion detected" when the camera detects motion:

Make sure the AXIS Video Motion Detection application is running:

1. Go to **Settings > Apps > AXIS Video Motion Detection**.
2. Start the application if it is not already running.
3. Make sure you have set up the application according to your needs.

Add the overlay text:

4. Go to **Settings > Overlay**.
5. Enter #D in the text field.
6. Choose alignment, text size and appearance.

Create an action rule:

7. Go to **System > Events > Action rules**.

AXIS P32 Network Camera Series

Setup

8. Create an action rule with AXIS Video Motion Detection as trigger.
9. From the list of actions, select **Overlay text**.
10. Type "Motion detected".
11. Set the duration.

Streaming and storage

How to choose video compression format

Decide which compression method to use based on your viewing requirements, and on the properties of your network. The available options are:

Motion JPEG

Motion JPEG or MJPEG is a digital video sequence that is made up of a series of individual JPEG images. These images are then displayed and updated at a rate sufficient to create a stream that shows constantly updated motion. For the viewer to perceive motion video the rate must be at least 16 image frames per second. Full motion video is perceived at 30 (NTSC) or 25 (PAL) frames per second.

The Motion JPEG stream uses considerable amounts of bandwidth, but provides excellent image quality and access to every image contained in the stream.

H.264 or MPEG-4 Part 10/AVC

Note

H.264 is a licensed technology. The Axis product includes one H.264 viewing client license. Installing additional unlicensed copies of the client is prohibited. To purchase additional licenses, contact your Axis reseller.

H.264 can, without compromising image quality, reduce the size of a digital video file by more than 80% compared to the Motion JPEG format and by as much as 50% compared to the MPEG-4 standard. This means that less network bandwidth and storage space are required for a video file. Or seen another way, higher video quality can be achieved for a given bitrate.

How to reduce bandwidth and storage

Important

If you reduce the bandwidth it can result in loss of details in the picture.

1. Go to live view and select H.264.
2. Go to **Settings > Stream**.
3. Do one or more of the following:
 - Turn on the Zipstream functionality and select the desired level.
 - Turn on dynamic GOP and set a high GOP length value.
 - Increase the compression.
 - Turn on dynamic FPS.

How to set up network storage

To store recordings on the network, you need to set up network storage:

1. Go to **Settings > System > Storage**.
2. Click **Setup** under **Network storage**.

AXIS P32 Network Camera Series

Setup

3. Enter the IP address of the host server.
4. Enter the name of the shared location on the host server.
5. Move the switch if the share requires a login, and enter username and password.
6. Click **Connect**.

How to add audio to your recording

Edit the stream profile which is used for the recording:

1. Go to **Settings > System > Stream profiles**.
2. Select the stream profile and click **Modify**.
3. In the **Audio** tab, select the **Audio stream** checkbox and select **On** from the drop-down list.
4. Click **Ok**.

How to record and watch video

To record video you must first set up network storage, see *How to set up network storage on page 15*, or have an SD card installed.

1. Go to the camera's live view.
2. Click on **Record** once to start recording and one more time to stop recording.

To watch your recording:

1. Click on **Storage > Go to recordings**.
2. Select your recording in the list and it will play automatically.

Events

About events

The event pages allow you to configure your product to perform actions when different events occur. For example, the product can start a recording or send an email notification when motion is detected. The set of conditions that defines how and when the action is triggered is called an action rule.

How to trigger an action

1. Go to **Settings > System > Events** to set up an action rule. The action rule defines when the camera will perform certain actions. Action rules can be setup as scheduled, recurring, or for example, triggered by motion detection.
2. Select what **Trigger** must be met to trigger the action. If you specify more than one trigger for the action rule, all of them must be met to trigger the action.
3. Select which **Action** the camera should perform when the conditions are met.

Note

If you make changes to an active action rule, the action rule needs to be restarted for the changes to take effect.

How to record video when the camera detects motion

This example explains how to set up the camera to start recording to the SD card five seconds before it detects motion and to stop one minute after.

Make sure the AXIS Video Motion Detection application is running:

AXIS P32 Network Camera Series

Setup

1. Go to **Settings > Apps > AXIS Video Motion Detection**.
2. Start the application if it is not already running.
3. Make sure you have set up the application according to your needs.

Create an action rule:

4. Go to **Settings > System > Events** and add an action rule.
5. Type a name for the action rule.
6. From the list of triggers, select **Applications** and then select **AXIS Video Motion Detection (VMD)**.
7. From the list of actions, select **Record video**.
8. Select an existing stream profile or create a new one.
9. Enable and set the pre-trigger time to 5 seconds.
10. Enable **While the rule is active**.
11. Enable and set the post-trigger time to 60 seconds.
12. Select **SD card** from the list of storage options.
13. Click **Ok**.

How to record video when a PIR detector senses motion

This example explains how to connect an Axis PIR detector to the camera, and set up the camera to start recording when the detector senses motion.

Required hardware

- 3-wire cable (ground, power, I/O)
- Axis PIR detector

NOTICE

Disconnect the camera from power before connecting the wires. Reconnect to power after all connections are done.

Connect the wires to the camera's I/O connector

Note

For information on the I/O connector, see *Connectors* on page 26

1. Connect the ground wire to pin 1 (GND/-).
2. Connect the power wire to pin 2 (12V DC output).
3. Connect the I/O wire to pin 3 (I/O input).

Connect the wires to the PIR detector's I/O connector

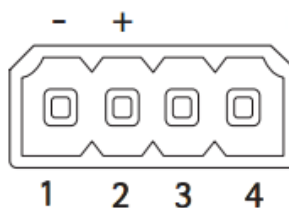

AXIS P32 Network Camera Series

Setup

1. Connect the other end of the ground wire to pin 1 (GND/-).
2. Connect the other end of the power wire to pin 2 (DC input/+).
3. Connect the other end of the I/O wire to pin 3 (I/O output).

Configure the I/O port in the camera's webpage

1. Go to **Settings > System > I/O ports**.
2. Give the input module a descriptive name.
3. To make the PIR detector send a signal to the camera when it senses motion, select **Closed circuit** in the drop-down list.

To trigger the camera to start recording when it receives a signal from the PIR detector, you need to create an action rule in the camera's webpage.

How to record video when the camera detects loud noises

This example explains how to set up the camera to start recording to the SD card five seconds before it detects loud noise and to stop one minute after.

Make sure audio turned on:

1. Set up the stream profile to include audio, see *How to add audio to your recording on page 16*.

Make sure the audio detection is set up:

2. Go to **Settings > System > Detectors > Audio detection**.
3. Adjust the alarm level according to your needs.

Create an action rule:

4. Go to **Settings > System > Events** and add an action rule.
5. Type a name for the action rule.
6. From the list of triggers, select **Detectors** and then select **Audio Detection**.
7. From the list of actions, select **Record video**.
8. Select the stream profile where audio has been turned on or create a new one.
9. Enable and set the pre-trigger time to 5 seconds.
10. Enable **While the rule is active**.
11. Enable and set the post-trigger time to 60 seconds.
12. Select **SD card** from the list of storage options.
13. Click **OK**.

How to use audio to deter intruders

This example explains how to connect a speaker to the camera and set it up to play a warning message when the camera detects motion in a restricted area.

Required hardware

- Speaker with connecting wires

AXIS P32 Network Camera Series

Setup

NOTICE

Make sure the camera is disconnected from power before making the connections. Reconnect to power after connecting the wires.

Physical connection

1. Connect the audio wire from the speaker to the AUDIO OUT pin on the camera. See *Product overview on page 5*.
2. Connect the grounding wire from the speaker to the GND AUDIO OUT pin on the camera. See *Product overview on page 5*.

Add audio clip to the camera

1. Go to **Settings > Audio > Output** and click  to add your audio clip.
2. Click **Add**.
3. Select **Upload** under **Add Audio Clip Options**.
4. Browse to locate the audio clip and click **Upload**.

To trigger the camera to play the audio clip when it detects motion, create an action rule in the camera's webpage.

How to detect tampering with input signal

This example explains how to trigger an alarm when the input signal has been cut or short-circuited. For more information about the I/O connector, see *page 26*.

1. Go to **Settings > System > I/O Ports** and enable **Supervised I/O**.

Create an action rule:

1. Go to **Settings > System > Events** and create an action rule.
2. Type a name for the action rule.
3. From the list of triggers, select **Input Signal** and then **Digital input port**. Select **Input 1** and set **Tampered to Yes**.
4. From the list of schedules, select **Always**.
5. From the list of actions, select **Send Notification** and then select a recipient or create a new recipient.
6. Click **OK**.

How to automatically send an email if someone spray paints the lens

1. Go to **System > Detectors**.
2. Turn on **Trigger on dark images**. This will trigger an alarm if the lens is sprayed, covered, or rendered severely out of focus.
3. Set a duration for **Trigger after**. The value indicates the time that must pass before an email is sent.

Create an action rule:

4. Go to **Events > Action rules** and add an action rule.
5. Enter a name for the action rule.
6. From the list of triggers, select **Detectors** and then select **Tampering**.
7. From the list of actions, select **Send Notification** and then select a recipient from the list or click **New Recipient** to create a new recipient.

AXIS P32 Network Camera Series

Setup

8. Enter name and address for the email.
9. Click Ok.

Applications

About applications

AXIS Camera Application Platform (ACAP) is an open platform that enables third parties to develop analytics and other applications for Axis products. To find out more about available applications, downloads, trials and licenses, go to axis.com/applications

To find the user manuals for Axis applications, go to axis.com

Note

- Several applications can run at the same time but some applications might not be compatible with each other. Certain combinations of applications might require too much processing power or memory resources when run in parallel. Verify that the applications work together before deployment.

AXIS People Counter

AXIS People Counter is an analytic application that can be installed on a network camera.

The counter is embedded in the camera which means you do not need a dedicated computer to run the application. AXIS People Counter is intended for retail environments, like stores or shopping malls, or other environments where you want to count people.

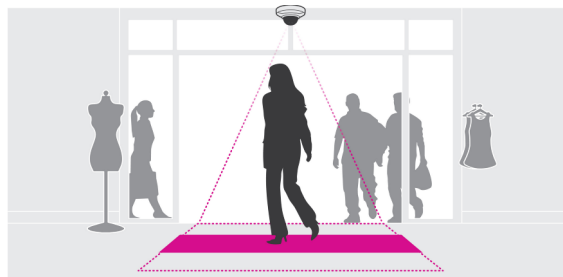

AXIS P32 Network Camera Series

Troubleshooting

Troubleshooting

If you can't find what you're looking for here, try the troubleshooting section at axis.com/support

How to reset to factory default settings

Important

Reset to factory default should be used with caution. A reset to factory default resets all settings, including the IP address, to the factory default values.

Note

The camera has been preconfigured with AXIS License Plate Verifier. If you reset to factory default, you need to reinstall the license key. See .

To reset the product to the factory default settings:

1. Disconnect power from the product.
2. Press and hold the control button while reconnecting power. See *Product overview on page 5*.
3. Keep the control button pressed for 15–30 seconds until the status LED indicator flashes amber.
4. Release the control button. The process is complete when the status LED indicator turns green. The product has been reset to the factory default settings. If no DHCP server is available on the network, the default IP address is 192.168.0.90
5. Use the installation and management software tools to assign an IP address, set the password, and access the video stream.

The installation and management software tools are available from the support pages on axis.com/support

It is also possible to reset parameters to factory default through the web interface. Go to **Settings > System > Maintenance** and click **Default**.

How to check the current firmware

Firmware is the software that determines the functionality of network devices. One of your first actions when troubleshooting a problem should be to check the current firmware version. The latest version may contain a correction that fixes your particular problem.

To check the current firmware:

1. Go to the product's webpage.
2. Click on the help menu. 
3. Click **About**.

How to upgrade the firmware

Important

Preconfigured and customized settings are saved when the firmware is upgraded (provided that the features are available in the new firmware) although this is not guaranteed by Axis Communications AB.

Important

Make sure the product remains connected to the power source throughout the upgrade process.

AXIS P32 Network Camera Series

Troubleshooting

Note

When you upgrade the product with the latest firmware, the product receives the latest functionality available. Always read the upgrade instructions and release notes available with each new release before upgrading the firmware. To find the latest firmware and the release notes, go to axis.com/support/firmware

1. Download the latest firmware file to your computer, available free of charge at axis.com/support/firmware
2. Log in to the product as an administrator.
3. Go to **Settings > System > Maintenance**. Follow the instructions on the page. When the upgrade has finished, the product restarts automatically.

AXIS Device Manager can be used for multiple upgrades. Find out more at axis.com/products/axis-device-manager

Technical issues, clues and solutions

If you can't find what you're looking for here, try the troubleshooting section at axis.com/support

Problems upgrading the firmware

Firmware upgrade failure	If the firmware upgrade fails, the product reloads the previous firmware. The most common reason is that the wrong firmware file has been uploaded. Check that the name of the firmware file corresponds to your product and try again.
--------------------------	---

Problems setting the IP address

The product is located on a different subnet	If the IP address intended for the product and the IP address of the computer used to access the product are located on different subnets, you cannot set the IP address. Contact your network administrator to obtain an IP address.
--	---

The IP address is being used by another device	Disconnect the Axis product from the network. Run the ping command (in a Command/DOS window, type <code>ping</code> and the IP address of the product): <ul style="list-style-type: none">• If you receive: <code>Reply from <IP address>: bytes=32; time=10...</code> this means that the IP address may already be in use by another device on the network. Obtain a new IP address from the network administrator and reinstall the product.• If you receive: <code>Request timed out</code>, this means that the IP address is available for use with the Axis product. Check all cabling and reinstall the product.
--	---

Possible IP address conflict with another device on the same subnet	The static IP address in the Axis product is used before the DHCP server sets a dynamic address. This means that if the same default static IP address is also used by another device, there may be problems accessing the product.
---	---

The product cannot be accessed from a browser

Cannot log in	When HTTPS is enabled, ensure that the correct protocol (HTTP or HTTPS) is used when attempting to log in. You may need to manually type <code>http</code> or <code>https</code> in the browser's address field. If the password for the user <code>root</code> is lost, the product must be reset to the factory default settings. See <i>How to reset to factory default settings on page 21</i> .
---------------	---

The IP address has been changed by DHCP	IP addresses obtained from a DHCP server are dynamic and may change. If the IP address has been changed, use AXIS IP Utility or AXIS Device Manager to locate the product on the network. Identify the product using its model or serial number, or by the DNS name (if the name has been configured). If required, a static IP address can be assigned manually. For instructions, go to axis.com/support
---	---

AXIS P32 Network Camera Series

Troubleshooting

The product is accessible locally but not externally

Router configuration	Check that your router allows incoming data traffic to the Axis product. The router must support UPnP®.
Firewall protection	Check the Internet firewall with your network administrator.

Problems with streaming

Multicast H.264 only accessible by local clients	Check if your router supports multicasting, or if the router settings between the client and the product need to be configured. The TTL (Time To Live) value may need to be increased.
No multicast H.264 displayed in the client	Check with your network administrator that the multicast addresses used by the Axis product are valid for your network. Check with your network administrator to see if there is a firewall preventing viewing.
Poor rendering of H.264 images	Ensure that your graphics card is using the latest driver. The latest drivers can usually be downloaded from the manufacturer's website.
Color saturation is different in H.264 and Motion JPEG	Modify the settings for your graphics adapter. Go to the adapter's documentation for more information.
Lower frame rate than expected	<ul style="list-style-type: none">• See <i>Performance considerations on page 23</i>.• Reduce the number of applications running on the client computer.• Limit the number of simultaneous viewers.• Check with the network administrator that there is enough bandwidth available.• Lower the image resolution.• Log in to the product's webpage and set a capture mode that prioritizes frame rate. Changing the capture mode to prioritize frame rate might lower the maximum resolution depending on the product used and capture modes available.

Performance considerations

When setting up your system, it is important to consider how various settings and situations affect the performance. Some factors affect the amount of bandwidth (the bitrate) required, others can affect the frame rate, and some affect both. If the load on the CPU reaches its maximum, this also affects the frame rate.

The following factors are the most important to consider:

- High image resolution or lower compression levels result in images containing more data which in turn affects the bandwidth.
- Rotating the lens manually will result in better performance compared to rotating the image from the GUI.
- Access by large numbers of Motion JPEG or unicast H.264 clients affects the bandwidth.
- Simultaneous viewing of different streams (resolution, compression) by different clients affects both frame rate and bandwidth.

Use identical streams wherever possible to maintain a high frame rate. Stream profiles can be used to ensure that streams are identical.

- Accessing Motion JPEG and H.264 video streams simultaneously affects both frame rate and bandwidth.
- Heavy usage of event settings affects the product's CPU load which in turn affects the frame rate.
- Using HTTPS may reduce frame rate, in particular if streaming Motion JPEG.
- Heavy network utilization due to poor infrastructure affects the bandwidth.
- Viewing on poorly performing client computers lowers perceived performance and affects frame rate.

AXIS P32 Network Camera Series

Troubleshooting

- Running multiple AXIS Camera Application Platform (ACAP) applications simultaneously may affect the frame rate and the general performance.

AXIS P32 Network Camera Series

Specifications

Specifications

To find the latest version of the product's datasheet, go to the product page at axis.com and locate **Support & Documentation**.

LED indicators

Status LED	Indication
Unlit	Connection and normal operation.
Green	Shows steady green for 10 seconds for normal operation after startup completed.
Amber	Steady during startup. Flashes during firmware upgrade or reset to factory default.
Amber/Red	Flashes amber/red if network connection is unavailable or lost.

SD card slot

⚠ CAUTION

 Risk of injury. Moving parts. Keep your body parts away from the product when in operation. Disconnect from power supply before installing or performing maintenance on the product.

⚠ CAUTION

 Risk of injury. Hot surface. Do not touch the product when in operation. Disconnect from power supply and allow the surfaces to cool before performing maintenance on the product.

NOTICE

- Risk of damage to SD card. Do not use sharp tools, metal objects, or excessive force when inserting or removing the SD card. Use your fingers to insert and remove the card.
- Risk of data loss and corrupted recordings. Do not remove the SD card while the product is running. Unmount the SD card from the product's webpage before removal.

This product supports microSD/microSDHC/microSDXC cards.

For SD card recommendations, see axis.com



microSD, microSDHC, and microSDXC Logos are trademarks of SD-3C LLC. microSD, microSDHC, microSDXC are trademarks or registered trademarks of SD-3C, LLC in the United States, other countries or both.

Buttons

Control button

The control button is used for:

- Resetting the product to factory default settings. See *How to reset to factory default settings on page 21*.
- Connecting to an AXIS Video Hosting System service. To connect, press and hold the button for about 3 seconds until the status LED flashes green.

AXIS P32 Network Camera Series

Specifications

Connectors

Network connector

RJ45 Ethernet connector with Power over Ethernet (PoE).

Audio connector

4-pin white terminal block for audio input and output.

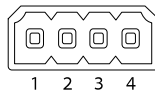

Function	Pin	Notes
GND	1	Ground
Ring power	2	12 V for external source
Microphone/Line in	3	Microphone (analog or digital) or line in (mono). 5 V microphone bias is available.
Line out	4	Line level audio output (mono). Can be connected to a public address (PA) system or an active speaker with a built-in amplifier.

I/O connector

Use the I/O connector with external devices in combination with, for example, motion detection, event triggering, and alarm notifications. In addition to the 0 V DC reference point and power (DC output), the I/O connector provides the interface to:

Digital input – For connecting devices that can toggle between an open and closed circuit, for example PIR sensors, door/window contacts, and glass break detectors.

Supervised input – Enables possibility to detect tampering on a digital input.

Digital output – For connecting external devices such as relays and LEDs. Connected devices can be activated by the VAPIX® Application Programming Interface or from the product's webpage.

4-pin terminal block

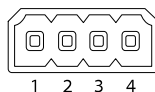

Function	Pin	Notes	Specifications
DC ground	1		0 V DC
DC output	2	Can be used to power auxiliary equipment. Note: This pin can only be used as power out.	12 V DC Max load = 25 mA
Digital Input or Supervised Input	3	Connect to pin 1 to activate, or leave floating (unconnected) to deactivate. To use supervised input, install end-of-line resistors. See connection diagram for information about how to connect the resistors.	0 to max 30 V DC
Digital Output	4	Connect to pin 1 to activate, or leave floating (unconnected) to deactivate. If used with an inductive load, e.g., a relay, connect a diode in parallel with the load, to protect against voltage transients.	0 to max 30 V DC, open drain, 100 mA

AXIS P32 Network Camera Series

Specifications

Example

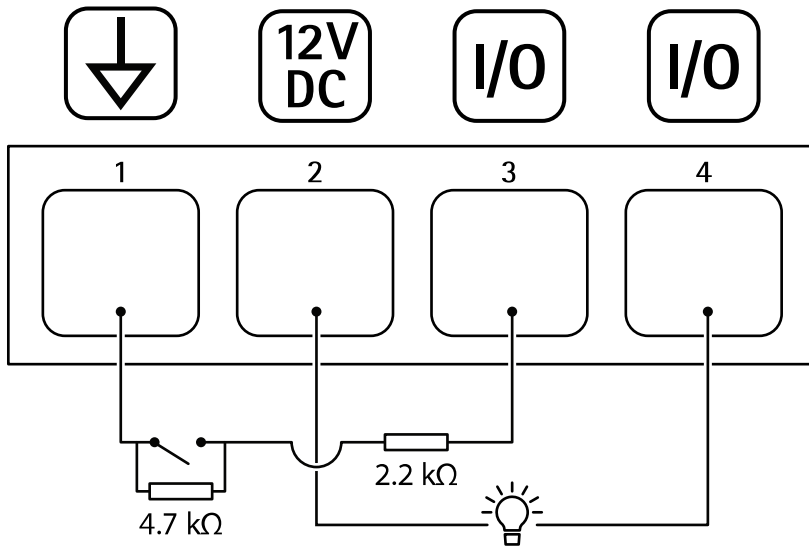

- 1 DC ground
- 2 DC output 12 V, max 25 mA
- 3 I/O supervised input
- 4 I/O digital output

