

USER'S MANUAL

AXIS P8221 Network I/O Audio Module



Notices

This manual is intended for administrators and users of the AXIS P8221 Network I/O Audio Module, and is applicable for firmware release 5.10 and later. It includes instructions for using and managing the product on your network. Previous experience of networking will be of use when using this product. Some knowledge of UNIX or Linux-based systems may also be beneficial, for developing shell scripts and applications. Later versions of this document will be posted to the Axis Website, as required. See also the product's online help, available via the Web-based interface.

Liability

Every care has been taken in the preparation of this manual. Please inform your local Axis office of any inaccuracies or omissions. Axis Communications AB cannot be held responsible for any technical or typographical errors and reserves the right to make changes to the product and manuals without prior notice. Axis Communications AB makes no warranty of any kind with regard to the material contained within this document, including, but not limited to, the implied warranties of merchantability and fitness for a particular purpose. Axis Communications AB shall not be liable nor responsible for incidental or consequential damages in connection with the furnishing, performance or use of this material.

Intellectual Property Rights

Axis AB has intellectual property rights relating to technology embodied in the product described in this document. In particular, and without limitation, these intellectual property rights may include one or more of the patents listed at <http://www.axis.com/patent.htm> and one or more additional patents or pending patent applications in the US and other countries.

This product contains licensed third-party software. See the menu item "About" in the product's user interface for more information.

This product contains source code copyright Apple Computer, Inc., under the terms of Apple Public Source License 2.0 (see <http://www.opensource.apple.com/apsl/>). The source code is available from: <http://developer.apple.com/darwin/projects/bonjour/>

Equipment Modifications

This equipment must be installed and used in strict accordance with the instructions given in the user documentation. This equipment contains no user-serviceable components. Unauthorized equipment changes or modifications will invalidate all applicable regulatory certifications and approvals.

Trademark Acknowledgments

Apple, Boa, Bonjour, Ethernet, Internet Explorer, Linux, Microsoft, Mozilla, Netscape Navigator, OS/2, Real, QuickTime, UNIX, Windows, WWW are registered trademarks of the respective holders. Java and all Java-based trademarks and logos are trademarks or registered trademarks of Sun Microsystems, Inc. in the United States and other countries. Axis Communications AB is independent of Sun Microsystems Inc. UPnP™ is a certification mark of the UPnP™ Implementers Corporation.

Support

Should you require any technical assistance, please contact your Axis reseller. If your questions cannot be answered immediately, your reseller will forward your queries through the appropriate channels to ensure a rapid response. If you are connected to the Internet, you can:

- download user documentation and firmware updates
- find answers to resolved problems in the FAQ database. Search by product, category, or phrases
- report problems to Axis support by logging in to your private support area
- visit Axis Support at www.axis.com/techsup

Contents

Overview	4
Key features	4
Hardware overview	5
Accessing the product	6
Access from a browser	6
Access from the Internet	6
Setting the root password	7
The Live View page	8
Audio Streams	10
AXIS Media Control (AMC)	10
Alternative methods of accessing audio	11
Setup Tools	12
Audio	13
Audio equipment	13
Audio Settings	14
Audio Clips	16
Ports & Devices	17
I/O Ports	17
COM Port	18
Live View Config	19
Layout	19
Events	21
Event Servers	21
Event Types	21
System Options	23
Security	23
Date & Time	24
Network	25
Maintenance	29
Support	29
Advanced	30
About	30
Resetting to Factory Default Settings	31
Unit connectors	32
LED indicators	34
Troubleshooting	35
Checking the firmware	35
Upgrading the firmware	35
Symptoms, possible causes, and remedial action	37
Index	39

Overview

This manual applies to the AXIS P8221 Network I/O Audio Module.

Key features

- **Eight configurable digital I/O ports**
AXIS P8221 enables remote control of I/O devices. The eight configurable input/output (I/O) ports allow devices such as sensors and relays to be integrated into a network video system.
- **Superb audio quality**
AXIS P8221 provides high-quality audio in simplex, half and full duplex. For improved quality, audio can be encoded in AAC at up to 128 kbit/s with 32 kHz sampling. G.711 and G.726 are also supported.
- **Speaker output**
AXIS P8221 offers different alternatives for audio output including line out and amplified speaker output.
- **Balanced microphone support**
Built-in pre-amplifier and phantom power saves installation costs by allowing balanced microphones to be connected directly to AXIS P8221.
- **Power over Ethernet**
With support for Power over Ethernet (PoE) no extra cables are needed for power, making the installation easy and reliable.
- **Control over legacy equipment**
Analog equipment can be controlled via the RS-232/RS-422/RS-485 serial port.

Hardware overview

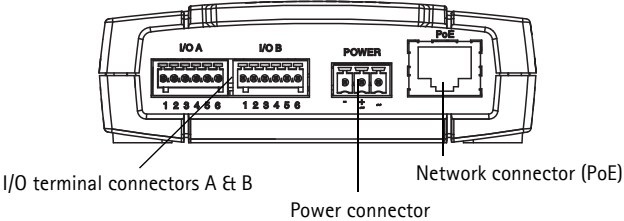
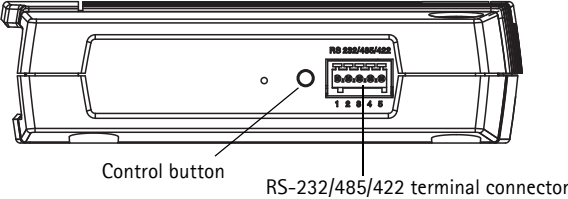
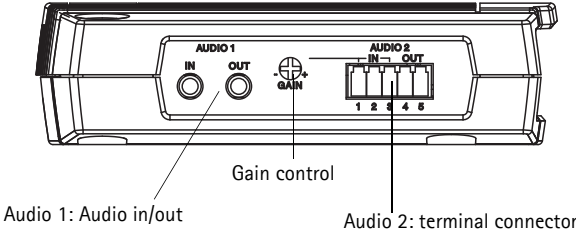
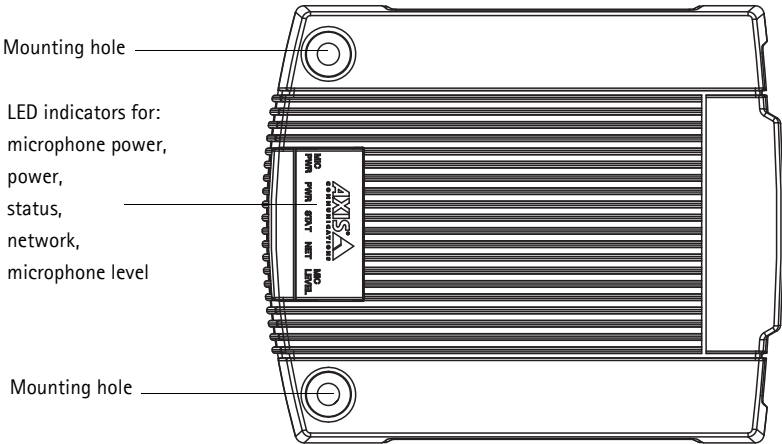

For descriptions of the connectors, please refer to *Unit connectors*, on page 32.

Accessing the product

To install the AXIS P8221 Network I/O Audio Module, refer to the Installation Guide supplied with your product.

AXIS P8221 can be used with most operating systems and browsers. The recommended browsers are Internet Explorer with Windows, Safari with Mac OSX and Firefox with other operating systems. See *Technical Specifications*, on page 39.

Notes:

- To access audio using Internet Explorer, set your browser to allow ActiveX controls and install AXIS Media Control (AMC) on your workstation.
- Internet Explorer with AXIS Media Control is recommended for full functionality.
- For one-way audio, QuickTime™ is also supported.
- The product includes one (1) AAC decoder license for accessing audio streams using AMC. The license is automatically installed with AMC. The administrator can disable installation of the decoder, to prevent installation of unlicensed copies.

Access from a browser

1. Start a browser (Internet Explorer, Firefox, Safari).
2. Enter the device's IP address or host name in the **Location/Address** field of your browser.
To access the device from a Macintosh computer (Mac OSX), click on the Bonjour tab and select AXIS P8221 from the drop-down list.
3. If this is the first time you access the product, see *Setting the root password*, on page 7. Otherwise enter your user name and password, set by the administrator.
4. The **Live View** page appears in your browser.

Note:

The layout of the Live View page depends on your browser and can also be customized to specific requirements. The image below shows a customized Live View page in Internet Explorer; some features may differ from those displayed on your own Live View page.



Access from the Internet

Once connected, AXIS P8221 is accessible on your local network (LAN). To access AXIS P8221 from the Internet you must configure your broadband router to allow incoming data traffic to the device. To do this, enable the NAT-traversal feature, which will attempt to automatically configure the router to allow access to the device. This is enabled from **Setup > System Options > Network > TCP/IP Advanced**.

For more information, please see *NAT traversal (port mapping) for IPv4*, on page 26. See also AXIS Internet Dynamic DNS Service at www.axiscam.net For Technical notes on this and other topics, visit Axis Support web at www.axis.com/techsup

Setting the root password

To gain access to the product, you must set the password for the default administrator user – 'root'. This is done in the 'Configure Root Password' dialog, which appears when AXIS P8221 is accessed for the first time. To prevent network eavesdropping the root password can be set via an encrypted HTTPS connection, which requires an HTTPS certificate.

Note:

HTTPS (Hypertext Transfer Protocol over SSL) is a protocol used to encrypt traffic between web browsers and servers. The HTTPS certificate ensures encrypted exchange of information.

To create an HTTPS connection, click this button.

To configure the password directly via an unencrypted connection, enter the password here.

To set the password via a standard HTTP connection, enter it directly in the first dialog shown above.

To set the password via an encrypted HTTPS connection, follow these steps:

1. Click the **Create self-signed certificate** button.
2. Provide the requested information and click **OK**. The certificate is created and the password can now be set securely. All traffic to and from AXIS P8221 is encrypted from this point on.
3. Enter a password and then re-enter it to confirm the spelling. Click **OK**. The password has now been configured.

Notes:

- The default administrator user name 'root' is permanent and cannot be deleted.
- If the password for root is lost, the product must be reset to the factory default settings. See page 31.
- If prompted, click **Yes** to install AXIS Media Control, which gives access to the audio stream in Internet Explorer. You will need administrator rights on the computer to do this. If using Windows Vista you must also run Internet Explorer as administrator; right-click the Internet Explorer icon and select **Run as administrator**.
- If required, click the link to install the **AAC decoder**.

The Live View page

The Live View page of AXIS P8221 can be used to:

- Display the status of input ports
- Control devices connected to output ports
- Access two-way audio (listen and talk) via AXIS Media Control (Internet Explorer only)
- View an external video source via AXIS Media Control (Internet Explorer only), see *View an external video source*, on page 20
- Play audio clips

If your device has been customized to meet specific requirements the buttons and other items described below may or may not be displayed on the Live View page. The following provides an overview of each available button:

General controls

These buttons and controls are configured under Setup > Live View Config > Layout.



Output buttons control devices connected to the output ports directly from the Live View page.

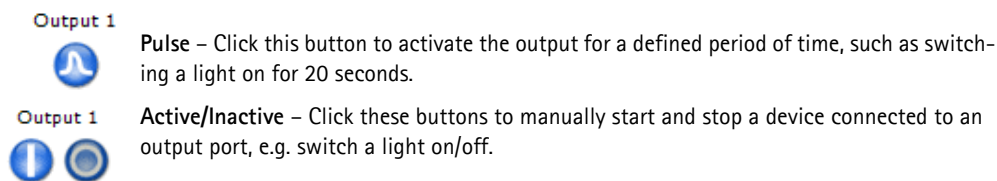

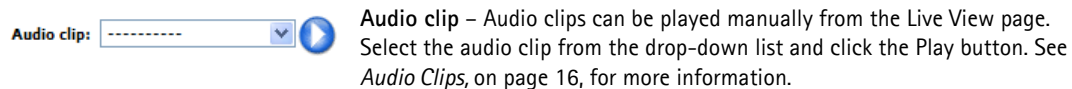

Pulse – Click this button to activate the output for a defined period of time, such as switching a light on for 20 seconds.

Active/Inactive – Click these buttons to manually start and stop a device connected to an output port, e.g. switch a light on/off.





AXIS Media Control toolbar

The AXIS Media Control viewer toolbar is available in Internet Explorer only. See *AXIS Media Control (AMC)*, on page 10 for more information. The toolbar displays the following buttons:

-  The **Play** button connects to the Axis product and starts playing a media stream.
-  The **Stop** button stops the media stream being played.
-  The **Record** button is used to record the current media stream (video and/or audio). The location where the recording is saved can be specified in the AMC Control Panel.

The following buttons are available when video from an external video source (see page 20) is displayed on the Live View page:

-  The **Snapshot** button takes a snapshot of the current image. The location where the image is saved can be specified in the AMC Control Panel.
-  Click the **View Full Screen** button and the video image will fill the entire screen. Press **Esc** (Escape) on the computer keyboard to cancel full screen view.

AMC Audio controls

AMC audio buttons control the speakers and microphone connected to the client computer.



Speaker button – Click to switch the sound on or off.



Microphone button – Click to switch the sound on or off.

In Simplex - Network I/O Audio Module speaker only mode, click this button to stop sending audio to the device.



Use the sliders to control the **volume** of the speakers and the microphone.



Half-duplex mode

The **Talk/Listen button** is used to switch between sending and receiving audio. The button can be configured from the Audio tab in the AMC Control panel:

- Push-To-Talk mode: Click and hold the button to talk/send, release the button to listen.
- Toggle mode: Click once to switch between talking and listening.

Simplex – Network I/O Audio Module speaker only mode

To send audio, the Talk and Microphone buttons must both be enabled. Click either button to stop audio transmission.

Audio Streams

AXIS P8221 provides several audio stream formats. Your requirements and the properties of your network will determine the type you use.

The Live View page provides access to audio streams. Other applications and clients can access audio streams directly, without going via the Live View page.

AXIS Media Control (AMC)

AXIS Media Control (AMC) in Internet Explorer in Windows is the recommended method of accessing audio from the product.

The AMC Control Panel can be used to configure various audio and network settings. Please see the AXIS Media Control User’s Manual for more information.

The AMC Control Panel is automatically installed on first use, after which it can be configured. Open the AMC Control Panel from:

- Windows Control Panel (from the Start menu)
- Right-click above the AMC Toolbar on the Live View page and select **Settings**

AXIS Media Control negotiates with the network product to determine the transport protocol to use. Deciding which combination of protocols and methods to use depends on your requirements, and on the properties of your network. The order of priority, listed in the AMC Control Panel, can be changed and the options disabled, to suit specific requirements.

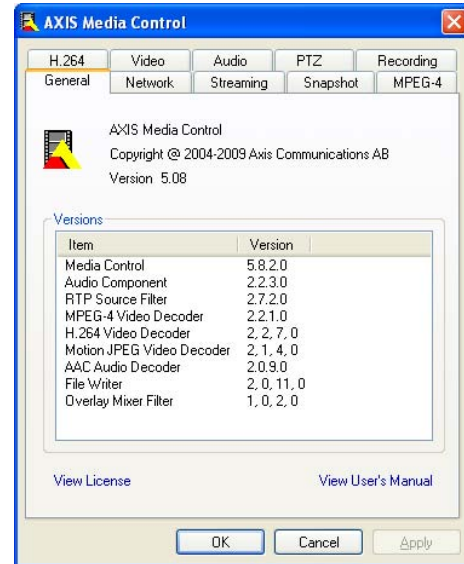

Unicast RTP	This unicast method (RTP over UDP) is used for live unicast audio, especially when it is important to always have an up-to-date stream, even if some audio data is lost.	Unicasting is used for audio-on-demand transmission, so that there is no traffic on the network until a client connects and requests the stream. Note that there are a maximum of 20 simultaneous unicast connections.
RTP over RTSP	This unicast method (RTP tunneled over RTSP) is useful as it is relatively simple to configure firewalls to allow RTSP traffic.	
RTP over RTSP over HTTP	This unicast method can be used to traverse firewalls. Firewalls are commonly configured to allow the HTTP protocol, thus allowing RTP to be tunneled.	
Multicast RTP	This method (RTP over UDP) should be used for live multicast audio. The stream is always up-to-date, even if some audio data is lost. Multicasting provides the most efficient usage of bandwidth when there are large numbers of clients accessing audio simultaneously. A multicast cannot however, pass a network router unless the router is configured to allow this. It is not possible to multicast over the Internet, for example. Note also that all multicast clients count as one unicast client in the maximum total of 20 simultaneous connections.	

Alternative methods of accessing audio

QuickTime and Windows Media Player

Simplex audio can be accessed via QuickTime and Windows Media Player by using the paths below. QuickTime supports G.711 and AAC audio encoding.

- Windows Media Player. This requires AXIS Media Control to be installed. The paths that can be used are listed below in the order of preference:
 - Unicast via RTP: `axrtpu://<ip>/axis-media/media.amp`
 - Unicast via RTSP: `axrtsp://<ip>/axis-media/media.amp`
 - Unicast via RTSP, tunneled via HTTP: `axrtsphhttp://<ip>/axis-media/media.amp`
 - Multicast: `axrtpm://<ip>/axis-media/media.amp`
- To access audio from **QuickTime™** the following paths can be used:
 - `rtsp://<ip>/axis-media/media.amp`
 - `rtsp://<ip>/axis-media/media.3gp`

Notes:

- AXIS P8221 supports QuickTime 6.5.1 and later.
- QuickTime adds latency to the audio stream (up to 3 seconds).
- It may be possible to use other players, although Axis does not guarantee this.
- `<ip>` = IP address

VAPIX®

Audio streamed via RTP/RTSP can be accessed through the VAPIX® application programming interface (API). For more information visit <http://www.axis.com/techsup>

Setup Tools

AXIS P8221 can be configured by users with administrator or operator rights:

- Administrators have unrestricted access to all settings.
- Operators have access to Audio, Live View Config and Events.

To configure the product, click **Setup** in the top right-hand corner of the Live View page. Click  to access the online help that explains the setup tools.

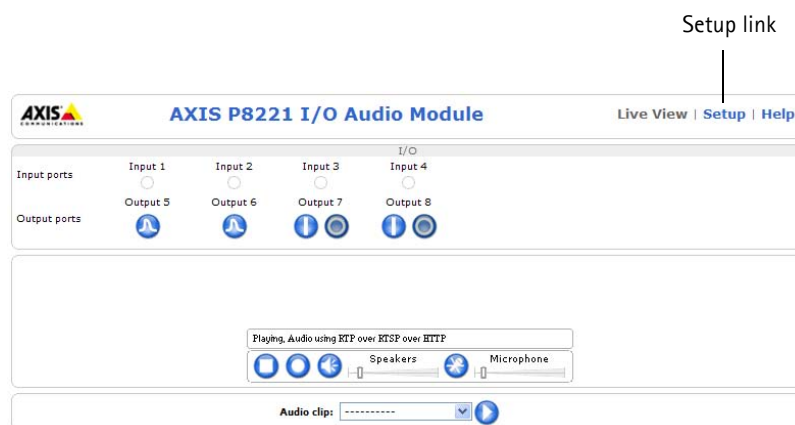

Audio

Audio equipment

AXIS P8221 has two connectors, Audio 1 and Audio 2, for external audio equipment. See table below for examples of supported audio equipment.

The Audio 2 terminal connector can power microphones requiring 48 V phantom power and has a built-in amplifier enabling direct connection of passive speakers. The Audio 1 connector can power small electret microphones.

Please see *Unit connectors*, on page 32, for wiring information.

Examples of supported audio equipment		
	Audio 1 (3.5 mm audio jacks)	Audio 2 (terminal connector)
Input	Electret microphone Unbalanced dynamic microphone Line in	Balanced microphone
Output	Line out Active speaker Headphones	Passive speaker

Notes:

- Input from Audio 1 can be combined with output from Audio 2, and vice versa
- If speakers are connected to both Audio 1 and Audio 2, the Audio 1 output will be used

Input gain adjustment (Audio 2)

The gain adjustment screw and mic level LED indicator are used to configure the input gain for microphones connected to Audio 2.

The mic level LED indicates the strength of the sound captured by the microphone. To minimize distortions, the LED should turn amber, but not red, at the highest sound levels.

To adjust the gain, reproduce the loudest sounds the microphone will be exposed to and simultaneously turn the gain screw using a screwdriver until the mic level LED shows amber.

Note:

The mic level LED is enabled and disabled under **Setup > Audio Settings > Audio Input**.

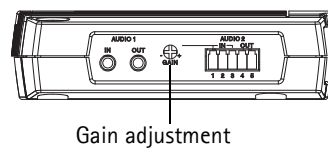
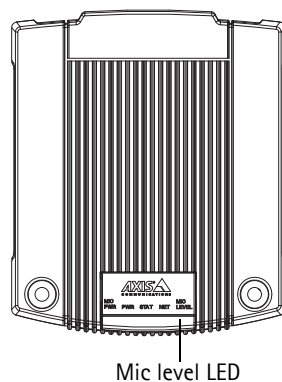

Audio Settings

The audio settings are configured under **Setup > Audio > Audio Settings**.

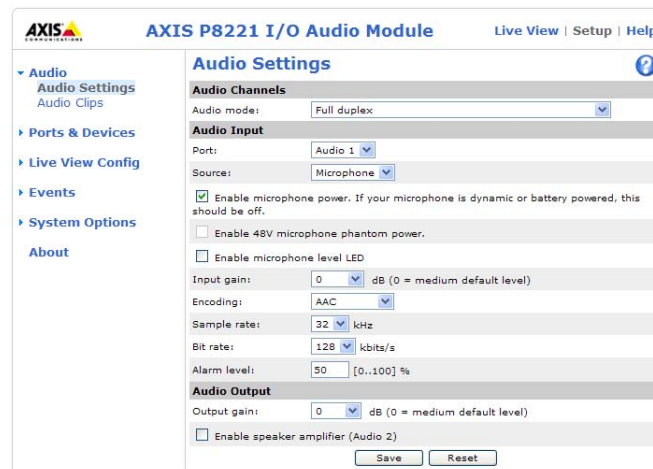

Audio Channels

Audio mode – The available audio modes are

- **Full duplex.** Simultaneous two-way audio allowing you to transmit and receive audio (talk and listen) at the same time.
Note: There is no echo cancellation; if feedback loops appear, try moving the microphone or the speaker.
- **Half duplex.** Audio can be transmitted in both directions between AXIS P8221 and the client computer, but only in one direction at a time. You must actively transmit/receive sound using the **Talk/Listen** button available on the Live View page (see *AXIS Media Control toolbar*, on page 8). In Push-To-Talk mode, click and hold the button to speak and release it when finished speaking. In Toggle mode, click once to switch between speaking and listening.
Note: The Talk/Listen button is configured from the Audio tab in the AMC control panel (see *AXIS Media Control (AMC)*, on page 10).
- **Simplex – Network I/O Audio Module speaker only.** Audio is transmitted from the client to AXIS P8221 and played by the speaker connected to AXIS P8221. To send audio, the **Talk** and **Microphone** buttons in the AMC toolbar must both be enabled. Click either button to stop audio transmission.
- **Simplex – Network I/O Audio Module microphone only.** Audio captured by the microphone connected to AXIS P8221 is transmitted from the device to one or more clients.

Audio Input

To configure the audio input settings, first select Audio 1 or Audio 2 from the **Port** drop-down list. When using Audio 1, set the audio **Source** to Microphone or Line depending on the connected device.

AXIS P8221 can power connected microphones:

- The **Enable microphone power** option provides DC power for a microphone connected to **Audio 1**. If using a small electret condenser microphone such as a clip-on microphone or a computer microphone, enable this option.
- The **Enable 48V microphone phantom power** option provides 48 V DC phantom power to a microphone connected to **Audio 2**.

Note:

Do not enable microphone power when using a high impedance dynamic microphone connected to Audio 1. Microphone power will not harm the microphone; if you are uncertain, try switching it off and on.

The mic level LED can be enabled and disabled by the **Enable microphone level LED** option.

If the sound input is too low or too high, adjust the **input gain** for the microphone attached to AXIS P8221. See also *Input gain adjustment (Audio 2)*, on page 13.

Select the desired audio **Encoding** format, G711 μ -law, G726 or AAC.

Select the required **Sample rate** (number of times per second the sound is sampled). The higher the sample rate, the better the audio quality and the greater the bandwidth required.

Changing the **Bit rate** changes the audio compression level and hence audio quality. A higher bit rate can improve audio quality but requires more bandwidth.

AXIS P8221 can be configured to trigger an event if the incoming sound level rises above, falls below, or passes the set **Alarm level**.

Audio Output

If the sound from the connected speaker (connected to Audio 1 or Audio 2) is too low or too high, adjust the **Output gain**.

To use the built-in amplifier for speakers connected to Audio 2, check **Enable speaker amplifier (Audio 2)**.

Note:

If speakers are connected to both Audio 1 and Audio 2, the Audio 1 output will be used.

The settings under Audio Input (see above) also determine the audio output format used when sending audio to AXIS P8221 from AXIS Media Control. See table below for details.

Audio input settings	Audio output format
G.711 μ -law	μ -law 16 kHz
G.726 24 kbit/s	G.726 24 kbit/s
G.726 32 kbit/s	G.726 32 kbit/s
AAC	μ -law 16 kHz

Audio detection

AXIS P8221 can be configured to alarm when the sound detected by the microphone rises above, falls below or passes the alarm level:

1. Go to **Setup > Audio > Audio Settings** and set the **alarm level**.
2. Go to **Setup > Events > Event Types** and create a **triggered event**, see *How to set up a triggered event*, on page 22.
3. Select **Audio detection** from the **Triggered by...** list.
4. Select the desired event action(s) under **When triggered...**, see page 22.

See *Events*, on page 21, for more information about events.

Audio Clips

An audio clip is a sound file that can be played when an event occurs or manually from the Live View page. Audio clips can be recorded by a microphone connected to AXIS P8221 or uploaded to the device.

Add a new audio clip

To add an audio clip, go to **Setup > Audio > Audio Clips** and click **Add...** The dialog expands with two choices **Record** and **Upload**.

Record

To record a clip using the microphone:

1. Select the **Record** radio button.
2. Enter a descriptive **Name**.
3. If the recording should not start immediately upon clicking the **Record...** button, enter the number of seconds to wait.
4. Enter the number of seconds to record.
5. Click **Record...** to start the recording. Once started, the recording cannot be aborted.

Notes:

- The Status indicator flashes amber while waiting to record and flashes red while recording.
- If audio quality is not satisfactory, try adjusting the Input gain under Audio Settings.
- Recording time is limited to 60 seconds.

Upload

To upload a file from a local hard drive or network disk, select the **Upload** radio button and click **Browse**. Navigate to the desired file and click **Upload**.

Supported file formats for audio clips:

File type	Encoding	Sample rate (kHz)
.au	G.711 μ -law, 8-bit, mono	8, 16
.wav	PCM, 16-bit, mono	8, 16, 32

Automatic audio announcements

AXIS P8221 can be configured to play automated audio announcements when triggered by a signal.

1. Go to **Setup > Audio > Audio Clips** and record or upload the audio clip containing the announcement. See above.
2. Go to **Setup > Events > Event Types** and create a **triggered event**, see *How to set up a triggered event*, on page 22.
3. Select the desired event trigger.
4. Under **When Triggered...**, check **Play audio clip** and select the audio clip from the drop-down list.

See *Events*, on page 21, for more information about events.

Ports & Devices

I/O Ports

AXIS P8221 has eight configurable input and output ports for connection of external devices.

- **Output ports** – For connecting external devices such as relays and switches. Devices connected to an output port can for example be used to remotely control devices such as lights and doors.
- **Input ports** – For connecting external alarm devices that can toggle between an open and closed (grounded) circuit, for example smoke detectors, PIRs, glass break detectors, door/window contacts.

Please refer to *Unit connectors*, on page 32, for information on how to connect external devices.

To configure a port, go to **Setup > Ports & Devices > I/O Ports** and select the port type (**Input**) or (**Output**) from the drop-down list. Ports can be given descriptive names and their **Normal states** can be configured as **Open circuit** or **Grounded circuit**.

The status (**Active** or **Inactive**) of each port is displayed under **Current State**.

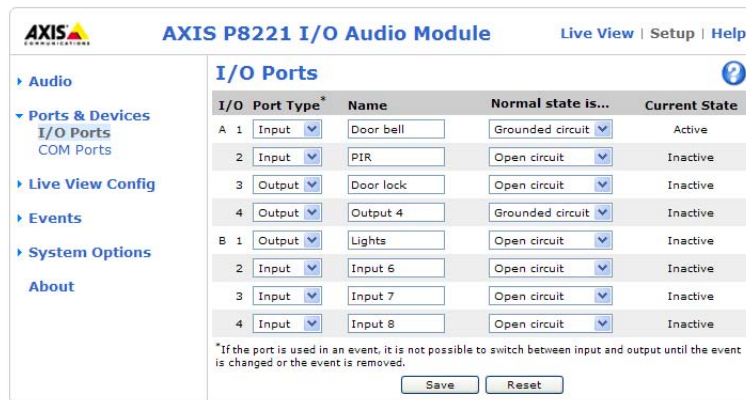



Note:

If a port is used in an event, the port type cannot be changed until the event is changed or removed.

Input ports

The current status of the input ports can be monitored on the Live View page:

Input 1  Input is active

Input 1  Input is inactive

To display input ports on the Live View page, go to **Setup > Live View Config** and check the boxes under Input ports.

Input ports can be used to trigger events, see *Events*, on page 21.

Output ports

Devices connected to output ports can be controlled by output buttons on the Live View page, by events and by the VAPIX® Application Programming Interface.

To display output buttons on the Live View page, go to **Setup > Live View Config** and select the type of control to use for the output from the drop-down list:

- **Pulse** – Activates the output for a defined period of time
- **Active/Inactive** – Displays two buttons, one for each action (on/off)

To control an output port by an event, go to **Setup > Events > Event Types** and set up an event, see *Events*, on page 21.

To control output ports via VAPIX®, please refer to the VAPIX® specification on the Developer pages at www.axis.com/developer

COM Port

AXIS P8221 has a RS-232/RS-485/RS-422 serial port for connection of auxiliary external equipment. See *Unit connectors*, on page 32, for information on how to connect external equipment.

To configure the serial port:

1. Go to **Setup > Ports & Devices > COM Ports**.
2. Select the **port mode** from the drop-down list. Click **Apply**.
3. If needed, change the port settings under Generic TCP/IP Settings.
4. Click **Save**.

Live View Config

Go to Setup > Live View Config > Layout to customize the appearance of the Live View page.

Layout

Viewer Settings

The administrator can disable the installation of the AAC decoder included with AXIS Media Control. This is used to prevent the installation of unlicensed copies. Further decoder licenses can be purchased from your Axis dealer.

Check **Enable recording button** to enable recording from the Live View page. The recordings are saved to the location specified in the AMC Control Panel, see *AXIS Media Control (AMC)*, on page 10.

Action Buttons

Check the **Play audio clips enabled** checkbox to display the audio clip drop-down list on the Live View page. See *Audio Clips*, on page 16.

User Defined Links

User-defined links can link to web pages, or can be used to run scripts or activate and control external devices connected to AXIS P8221. Once configured, the links appear on the Live View page.

To set up a link, check the **Show custom link** box, select the cgi or web link radio button, enter the URL and a descriptive name in the provided field.

A link defined as a web link will open in a new window, while a cgi link will run for example a script in the background.

User-defined cgi links can be used to issue API requests. For more information on the VAPIX® Application Programming Interface (API), see the Video developer pages at Axis Web site www.axis.com/developer

Input Ports

Check the boxes to display input ports and their status on the Live View page.

Output Buttons

The output buttons are used to manually activate and inactivate the output port, for example, to switch a light on and off. To display the output buttons on the Live View page, select the type of control to use for the port from the drop-down list:

- Pulse – Activates the output for a defined period of time
- Active/Inactive – Displays two buttons, one for each action (on/off)

View an external video source

Audio from AXIS P8221 can be combined with live video from Axis network cameras and video encoders. When enabled, live video is displayed on the Live View page (Internet Explorer only).

1. Go to Setup > Live View Config.
2. Under External Video Source Setup, check External video enabled.
3. Enter the IP address of the video source.
4. Select video format (H.264 or MPEG-4).
5. Optionally, enter the user name and password for the video source.

Note: If no user credentials are entered, a login window will appear when accessing the Live View page.

6. Click Save.

Notes:

- User name and password are saved and sent unencrypted.
- Select H.264 if the video source supports both H.264 and MPEG-4 video.
- To view live video, the H.264/MPEG-4 decoder provided with the video source must be installed on the client computer.
- To receive synchronized video and audio, it is recommended that the time settings in AXIS P8221, the video source and the client computer are synchronized with an NTP Server. This is enabled under Setup > System Options > Date & Time.

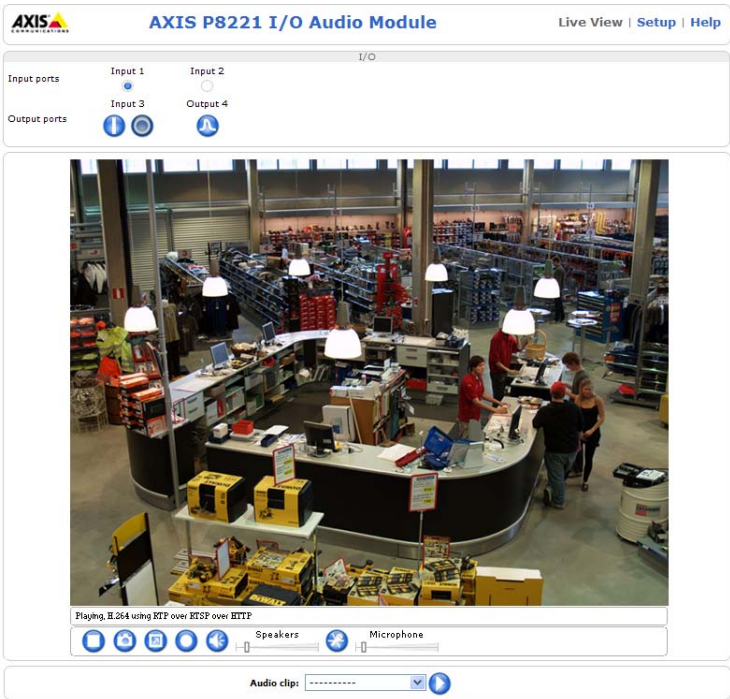

www.mycompany.com

User-defined link

Events

An event or **Event Type** in AXIS P8221 triggers certain actions when activated. The event is a set of parameters that defines these actions. A common event type is an alarm that causes AXIS P8221 to activate output ports.

A **triggered event** is an event that is started by a signal, for example from a device connected to the input ports.

A **scheduled event** runs at pre-programmed times.

An **action** refers to what happens when the event occurs, for example activation of an output port or sending a notification email.

Event Servers

Event Servers are used to receive notification messages. To set up an Event Server connection, go to **Setup > Events > Event Servers** and enter the required information for the required server type.

Server type	Purpose	Information required
HTTP Server	<ul style="list-style-type: none"> Receives notification messages 	<ul style="list-style-type: none"> Descriptive name URL (IP address or host name) User name and password Proxy settings
TCP Server	<ul style="list-style-type: none"> Receives notification messages 	<ul style="list-style-type: none"> Descriptive name Network address (IP address or host name) Port number

For details on each setting, see the online help  available from each web page.

When the setup is complete, the connection can be tested by clicking **Test** (the connection test takes approximately 10 seconds).

Event Types

An **Event Type** describes how and when the device performs certain actions. Up to 10 event types can be configured.

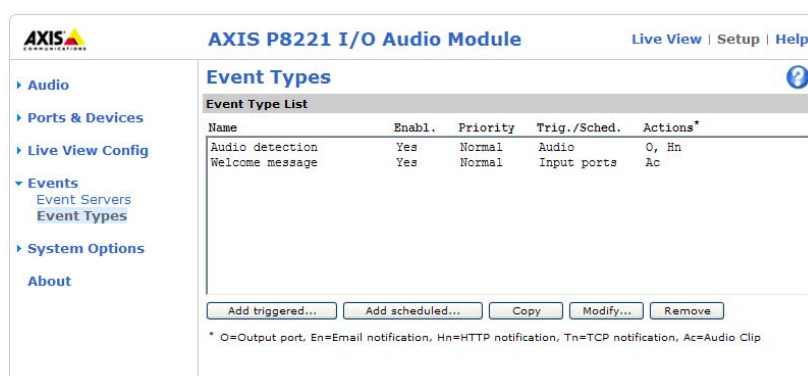

Example: If the sound level rises above the defined alarm level and an event has been configured to detect audio, AXIS P8221 can send notification messages and activate output ports, for example to lock or unlock doors.

Triggered Event

A triggered event can be activated by:

- Input ports – see page 17
- Audio detection – see page 15.
- On boot – for example after power loss

How to set up a triggered event

To set up a triggered event, follow these steps:

1. Go to **Setup > Events > Event Types**.
2. Click **Add triggered...** The **Triggered Event Type Setup** window appears.
3. Enter a descriptive **Name** for the event.
4. Set the **Priority** – High, Normal or Low.
5. Set the **Respond to Trigger...** parameters to define when the event is active, for example, after office hours.
6. Select the desired trigger from the **Triggered by...** drop-down list.
7. Set the **When Triggered...** parameters, that is, define what AXIS P8221 will do when the event is triggered.
8. Click **OK** to save the event in the Event Types list.

Please see the online help  for descriptions of each available option.

Scheduled event

A Scheduled event can be activated at preset times, in a repeating pattern on selected weekdays.

How to set up a scheduled event

To set up a scheduled event, follow these steps:

1. Go to **Setup > Events > Event Types**.
2. Click **Add scheduled...** The **Scheduled Event Type Setup** window appears.
3. Enter a descriptive **Name** for the event.
4. Set the **Priority** (High, Normal or Low).
5. Set the **Activation Time** parameters to define when the event will be active. For example, select **Recurrence pattern**, specify the desired weekdays, start time and duration.
6. Set the **When Activated...** parameters, that is, define what AXIS P8221 should do when the event is activated.
7. Click **OK** to save the Event in the Event Types list.

Please see the online help  for descriptions of each available option.

Event actions

When an event occurs, AXIS P8221 can

- Activate output ports – see page 17
- Send a notification message (email, HTTP, TCP) – Notification messages can be formatted using modifiers, see File Naming & Date/Time Formats in the online help.
- Play an audio clip – see page 16

System Options

Security

Users

User access control is enabled by default. An administrator can set up other users, by giving them user names and passwords. It is also possible to allow anonymous viewer login, which means that anybody may access the Live View page, as described below:

The user list displays the authorized users and user groups (levels):

Viewer	Provides the lowest level of access, which only allows access to the Live View page.
Operator	An operator can view the Live View page, create and modify events, and adjust certain other settings. Operators have no access to System Options.
Administrator	An administrator has unrestricted access to all menus for configuration and can determine the registration of all other users.

HTTP/RTSP Password Settings – Select the type of password. You may need to allow unencrypted passwords if there are clients that do not support encryption, or if you recently upgraded the firmware and the existing clients support encryption, but need to log in again, and be configured to use this functionality.

User Settings – Check the relevant box to enable **anonymous viewer login** – allows any viewer direct access to the Live View page.

IP Address Filter

Enable IP Address Filtering to allow or deny access to the device. Once enabled, the IP addresses in the list are allowed or denied access according to the choice made in the drop-down list **Allow/Deny the following IP addresses**.

The administrator can add up to 256 IP address entries to the list (a single entry can contain multiple IP addresses). The users from these IP addresses need to be specified in the user list with the appropriate access rights. This is done from **Setup > System Options > Security > Users**.

HTTPS

AXIS P8221 supports encrypted browsing using HTTPS.

A **self-signed certificate** can be used until a Certificate Authority-issued certificate has been obtained. Click the **Create self-signed certificate** button to install a self-signed certificate. Although self-signed certificates are free and offer some protection, true security is only implemented after the installation of a signed certificate issued by a Certificate Authority.

A signed certificate can be obtained from an issuing Certificate Authority by clicking the **Create Certificate Request** button. When the signed certificate is returned, click the **Install signed certificate** button to import the certificate. The properties of any certificate request currently resident in AXIS P8221 or installed can also be viewed by clicking the **Properties...** button. The HTTPS Connection Policy must also be set in the drop-down lists to enable HTTPS in the device.

For more information, please refer to the online help .

IEEE 802.1X

IEEE 802.1X is an IEEE standard for port-based Network Admission Control. It provides authentication to devices attached to a network port (wired or wireless), establishing a point-to-point connection, or, if authentication fails, preventing access on that port. 802.1X is based on EAP (Extensible Authentication Protocol).

In an IEEE 802.1X enabled network switch, clients equipped with the correct software can be authenticated and allowed or denied network access at the Ethernet level.

Clients and servers in an IEEE 802.1X network may need to authenticate each other by some means. In Axis implementation this is done with the help of digital certificates provided by a **Certification Authority**. These are then validated by a third-party entity, such as a **RADIUS server**, examples of which are Free Radius and Microsoft Internet Authentication Service. To perform the authentication, the RADIUS server uses various EAP methods/protocols, of which there are many. The one used in Axis implementation is EAPOL using EAP-TLS (EAP-Transport Layer Security).

The Axis network product presents its certificate to the network switch, which in turn forwards this to the RADIUS server. The RADIUS server validates or rejects the certificate and responds to the switch, and sends its own certificate to the client for validation. The switch then allows or denies network access accordingly, on a preconfigured port.

Certificates

CA Certificate – This certificate is created by the Certification Authority for the purpose of validating itself, so AXIS P8221 needs this certificate to check the server's identity. Provide the path to the certificate directly, or use the **Browse...** button to locate it. Then click the **Upload** button. To remove a certificate, click the **Remove** button.

Client certificate/private key – AXIS P8221 must also authenticate itself, using a client certificate and a private key. Provide the path to the certificate in the first field, or use the **Browse...** button to locate it. Then click the **Upload** button. To remove a certificate, click the **Remove** button.

Alternatively, it may be possible to upload the certificate and key in one combined file, (e.g. a PFX file or PEM file). Provide the path to the file, or use the **Browse...** button to locate it. Click **Upload** to load the file. To remove a certificate and key, click the **Remove** button.

Settings

EAPOL version – Select the EAPOL version (1 or 2) as used in your network switch.

EAP identity – Enter the user identity associated with your certificate. A maximum of 16 characters can be used.

Private key password – Enter the password (maximum 16 characters) for your user identity.

Enable IEEE 802.1X – Check the provided box to enable the IEEE 802.1X protocol.

Date & Time

Current Server Time

Displays the current date and time (24h clock). The time can be displayed in 12h clock format in the overlay (see below).

New Server Time

Select your **time zone** from the drop-down list. If you want the server clock to automatically adjust for daylight savings time, select the **Automatically adjust for daylight saving time changes** option.

Note:

The time zone setting only applies when the device's time is synchronized with an NTP server.

From the **Time mode** section, select the preferred method to use for setting the time:

- **Synchronize with computer time** – Sets the time from the clock on your computer.
- **Synchronize with NTP Server** – The time will be obtained from an NTP server.
- **Set manually** – This option allows you to manually set the time and date.

Note:

If using a host name for the NTP server, a DNS server must be configured under **TCP/IP** settings. See *Basic TCP/IP Settings*, on page 25.

Network

Basic TCP/IP Settings

AXIS P8221 supports both IP version 4 and IP version 6. Both versions may be enabled simultaneously, and at least one version must always be enabled. When using IPv4, the IP address can be set automatically via DHCP, or a static IP address can be set manually. If IPv6 is enabled, the device receives an IP address according to the configuration in the network router. There is also the option of using AXIS Internet Dynamic DNS Service. For more information on setting the IP address, please refer to the Installation Guide supplied with your product.

Network Settings

Click the **View** button for an overview of the IP configuration of the device.

IPv4 Address Configuration

Check the **Enable IPv4** box option to enable IPv4.

Obtain IP address via DHCP – Dynamic Host Configuration Protocol (DHCP) is a protocol that lets network administrators centrally manage and automate the assignment of IP addresses on a network. DHCP is enabled by default. Although a DHCP server is mostly used to set an IP address dynamically, it is also possible to use it to set a static, known IP address for a particular MAC address.

Note:

DHCP should only be enabled if using dynamic IP address notification, or if your DHCP server can update a DNS server, which then allows you to access AXIS P8221 by name (host name). If DHCP is enabled and you cannot access the unit, run AXIS IP Utility to search the network for connected Axis products or reset the unit to factory default settings and then perform the installation again.

Use the following IP address – To use a static IP address for AXIS P8221, check the radio button and then make the following settings:

- **IP address** – Specify a unique IP address for your AXIS P8221. (To check if the IP address you intend to use is available or not, click the Test button)
- **Subnet mask** – Specify the mask for the subnet AXIS P8221 is located on
- **Default router** – Specify the IP address of the default router (gateway) used for connecting devices attached to different networks and network segments.

IPv6 Address Configuration

Check the **Enable IPv6** box option to enable IPv6. Other settings for IPv6 are configured in the network router.

Services

Enable ARP/Ping setting of IP address – The IP address can be set using the ARP/Ping method, which associates the unit's MAC address with an IP address. Check this box to enable the service. Leave disabled to prevent unintentional resetting of the IP address.

Notes:

- The ARP/Ping service is automatically disabled two minutes after the unit is started, or as soon as an IP address is set. In order to reset the IP address, the unit must be restarted to activate ARP/Ping for an additional two minutes.
- Pinging the unit is still possible when this service is disabled.

AXIS Internet Dynamic DNS Service – Use AXIS Internet Dynamic DNS service to assign a host name for easy access to your device. Click **Settings...** to register the device with AXIS Internet Dynamic DNS service, or to modify the existing settings (requires access to the Internet). The domain name currently registered at AXIS Internet Dynamic DNS service for your product can at any time be removed.

For more information, please refer to www.axiscam.net and to the online help.

Advanced TCP/IP Settings

DNS Configuration

DNS (Domain Name Service) provides the translation of host names to IP addresses on your network.

Obtain DNS server address via DHCP – Automatically use the DNS server settings provided by the DHCP server. Click the **View** button to see the current settings.

Use the following DNS server address – Enter the desired DNS server by specifying the following:

- **Domain name** – Enter the domain(s) to search for the host name used by the device. Multiple domains can be separated by semicolons (;). The host name is always the first part of a Fully Qualified Domain Name, for example, myserver is the host name in the Fully Qualified Domain Name myserver.mycompany.com where mycompany.com is the Domain name.
- **DNS servers** – Enter the IP addresses of the primary and secondary DNS servers.
Note: This is not mandatory with regard to secondary DNS servers.

NTP Configuration

Obtain NTP server address via DHCP – Check this radio button to automatically look up and use the NTP server settings as provided by DHCP. Click the **View** button to see the current settings.

Use the following NTP server address – To create manual settings, check this radio button and enter the host name or IP address of the NTP server.

Host Name Configuration

AXIS P8221 can be accessed using a host name, instead of an IP address. The host name is usually the same as the assigned DNS Name.

Link-Local IPv4 Address

This is enabled by default and assigns the device an additional IP address for use with UPnP™. The device can have both a Link-Local IP and a static/DHCP-supplied IP address at the same time – these will not affect each other.

HTTP and HTTPS

The default HTTP/HTTPS port numbers (80 and 443 respectively) can be changed to any port within the range 1024-65535. This is useful for simple security port mapping, for example.

NAT traversal (port mapping) for IPv4

A broadband router allows devices on a private network (LAN) to share a single connection to the Internet. This is done by forwarding network traffic from the private network to the "outside", that is, the Internet. Security on the private network (LAN) is increased since most broadband routers are pre-configured to stop attempts to access the private network (LAN) from the public network (Internet).

Use **NAT traversal** when your device is located on an intranet (LAN) and you wish to make it available from the other (WAN) side of a NAT router. With NAT traversal properly configured, all HTTP traffic to an external HTTP port in the NAT router is forwarded to the device.

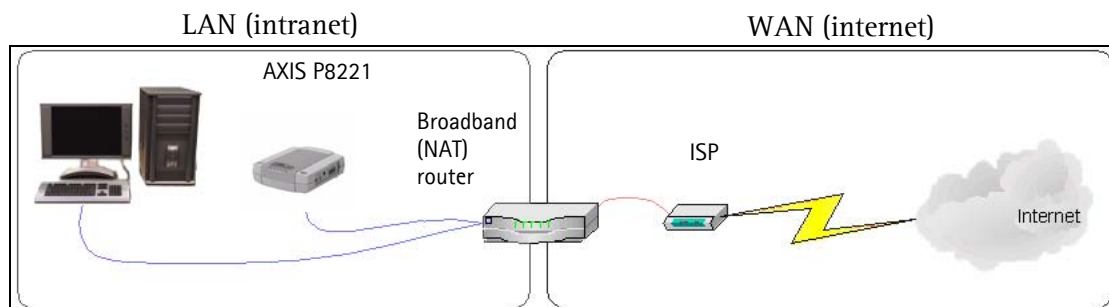

Notes:

- For NAT traversal to work, this must be supported by the broadband router. The router must also support UPnP™.
- The broadband router has many different names: "NAT router", "Network router", "Internet Gateway", "Broadband sharing device" or "Home firewall" but the essential purpose of the device is the same.

Enable/Disable – When enabled, the device attempts to configure port mapping in a NAT router on your network, using UPnP™. Note that UPnP™ must be enabled in the device (see **System Options > Network > UPnP**).

Use manually selected NAT router – Select this option to manually select a NAT router and enter the IP address for the router in the field provided.

If a router is not manually specified, the device automatically searches for NAT routers on your network. If more than one router is found, the default router is selected.

Alternative HTTP port – Select this option to manually define an external HTTP port. Enter the port number in the field provided. If no port is entered here a port number is automatically selected when NAT traversal is enabled.

Notes:

- An alternative HTTP port can be used/be active even if NAT traversal is disabled. This is useful if your NAT router does not support UPnP and you need to manually configure port forwarding in the NAT router.
- If you attempt to manually enter a port that is already in use, another available port is automatically selected.
- When the port is selected automatically it is displayed in this field. To change this enter a new port number and click Save.

FTP

The FTP server running in AXIS P8221 enables the upload of new firmware and user applications. Check the box to enable the service.

RTSP

The RTSP protocol allows a connecting client to start an audio stream. Check the box to enable the server and enter the RTSP port number to use. The default setting is 554. Note that audio streams will not be available if this service is not enabled.

SOCKS

SOCKS is a networking proxy protocol. The Axis product can be configured to use a SOCKS server to reach networks on the other side of a firewall/proxy server. This functionality is useful if the product is located on a local network behind a firewall, and notifications, alarms, and such need to be sent to a destination outside the local network (such as the Internet). See the online help  for more information.

QoS (Quality of Service)

Quality of Service (QoS) guarantees a certain level of a specified resource to selected traffic on a network. Quality can be defined as a maintained level of bandwidth, low latency, and no packet losses. The main benefits of a QoS-aware network can be summarized as:

- The ability to prioritize traffic and thus allow critical flows to be served before flows with lesser priority.
- Greater reliability in the network, thanks to the control of the amount of bandwidth an application may use, and thus control over bandwidth races between applications.

The QoS in Axis products marks the data packets for various types of network traffic originating from the product. This makes it possible for network routers and switches to reserve a fixed amount of bandwidth for these types of traffic. The device marks the following types of traffic:

- live audio
- event/alarm
- management network traffic

QoS Settings – For each type of network traffic supported by your Axis network video product, enter a DSCP (Differentiated Services Codepoint) value. This value is used to mark the traffic's IP header. When the marked traffic reaches a network router or switch, the DSCP value in the IP header tells the router or switch the type of treatment to apply to this type of traffic, for example, how much bandwidth to reserve for it. Note that DSCP values can be entered in decimal or hex form, but saved values are always shown in decimal.

For more information on Quality of Service, please see the Axis support web at www.axis.com/techsup

SMTP (email)

Enter the host names (or IP addresses) and port numbers for your primary and secondary mail servers in the fields provided, to enable the sending of notification messages from AXIS P8221 to predefined addresses via SMTP.

If your mail server requires authentication, check the box for **Use authentication to log in to this server** and enter the necessary information. See the online help  for more information.

SNMP

The Simple Network Management Protocol (SNMP) allows remote management of network devices. An SNMP community is the group of devices and management station running SNMP. Community names are used to identify groups.

Depending on the level of security required, select the version of SNMP to use.

SNMP v1/v2

Select either SNMP V1 that includes no security, or SNMP V2c that uses very simple security.

The community name can be specified as a password for read or read/write access to all supported SNMP objects. The community is the group of network devices using SNMP. The default password for the **Read Community** is **public** and the default password for the **Write community** is **write**.

Traps for SNMP v1/v2

Traps are used by AXIS P8221 to send messages to a management system for important events or status changes.

If **Enable traps** is selected, enter the email address where the trap message is to be sent as well as the **Trap community** that should receive the message.

There are four types of traps available for AXIS P8221.

- Cold start
- Warm start
- Link up
- Authentication failed

SNMP v3

SNMP V3 – provides encryption and secure passwords. HTTPS must be enabled. To use traps with SNMP v3 an SNMP v3 management application is required.

If the **Enable SNMP v3** option is enabled, provide the Initial user password. Note that the initial password is activated only when HTTPS is enabled and can only be set once.

If HTTPS is enabled, SNMP v1 and SNMP v2c should be disabled.

When SNMP configuration is ready, click **Save** to use the new settings or **Reset** to return to the default values.

UPnP™

AXIS P8221 includes support for UPnP™. UPnP™ is enabled by default, and the device then is automatically detected by operating systems and clients that support this protocol.

RTP/Audio

These settings are the port range, IP address, port number, and Time-To-Live value to use for multicast audio stream(s). Only certain IP addresses and port numbers should be used for multicast streams. For more information please see the online help.

Bonjour

AXIS P8221 includes support for Bonjour. When enabled, the device is automatically detected by operating systems and clients that support this protocol.

Maintenance

Restart – The device is restarted without changing any settings.

Restore – The device is restarted and most current settings are reset to factory default values. The settings that do not reset are:

- the boot protocol (DHCP or static)
- the static IP address
- the default router
- the subnet mask
- the product interface language
- the system time
- the 802.1x settings

Default – The default button should be used with caution. Pressing this returns all settings to the factory default values (including the IP address).

Upgrade Server – See *Upgrading the firmware*, on page 35.

Support

Support Overview

The **Support Overview** page provides valuable information on troubleshooting and contact information, should you require technical assistance.

System Overview

System Overview is an overview of the device's status and settings. Information that can be found here includes firmware version, IP address, security, event settings and recent log items. Many of the captions are also links to the proper **Setup page** to conveniently make adjustments in the device's settings.

Logs & Reports

When contacting Axis support, please be sure to provide a valid Server Report with your query. The Access Log is automatically included in the server report.

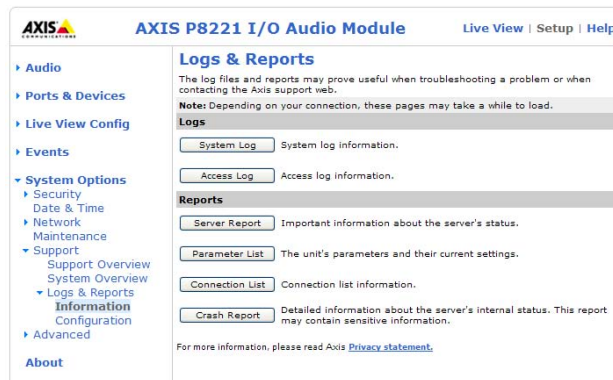

Information

The **Server Report** and **Parameter List** may prove useful when troubleshooting a problem or when contacting the Axis support.

- **System Log** - Provides information about system events.
- **Access Log** - By default, the Access Log lists all failed attempts to access the device but can be configured to list all connections to the device, whether successful or not. Go to **Support > Logs & Reports > Configuration** and select the desired level of information from the list. See below for more information. The Access Log is useful for various purposes such as tracking all access to the product, system analysis and troubleshooting.
- **Server Report** - Provides information about the server status and should always be included when requesting support.
- **Parameter List** - Shows the unit's parameters and their current settings.
- **Connection List** - Lists all clients that are currently accessing the product. It is also used for system analysis and troubleshooting.
- **Crash Report** - Generates an archive with debugging information. Note that the report takes several minutes to generate.

Configuration

From the drop-down lists, select the size and level of information to be added to the **System Log** and **Access Log** files.

The default information level for the Access Log is set to Critical & Warnings, i.e. failed connections. However, in an error situation and when requesting support, set it to the highest information level Critical & Warnings & Info.

For the **Log Level for Email**, select from the drop-down list the level of information to send as email and enter the destination email address.

Advanced

Scripting

Scripting is an advanced function that enables you to customize and use scripts. This function is a very powerful tool.

Caution!

Improper use may cause unexpected behavior or even cause loss of contact with the unit. If a script does cause problems, reset the unit to its factory default settings.

Axis strongly recommends that you do not use this function unless you understand the consequences. Note that Axis support does not provide assistance for problems with customized scripts.

For more information, please visit the Video developer pages at www.axis.com/developer

File Upload

Files (e.g. web pages and images) can be upload to AXIS P8221 and used as custom settings. Uploaded files are accessed through `http://<ip address>/local/<user>/<file name>` where <user> is the selected user access group (viewer, operator or administrator) for the uploaded file.

Plain Config

Plain Config is for the advanced user with experience of Axis network video product configuration. All parameters can be set and modified from this page. Help is available from the standard help pages.

About

Here you can find basic information about your AXIS P8221. You can also view third party software licenses.

Resetting to Factory Default Settings

To reset the unit to the original factory default settings, go to the **System Options > Maintenance** web page (as described in *Maintenance*, on page 29) or use the **Control button** on the side of the unit (see page 5) as described below:

Using the Control Button

This will reset all parameters, including the IP address, to the factory default settings:

1. Disconnect power from the device.
2. Press and hold the Control button while reconnecting power.
3. Keep the Control button pressed until the **Status indicator** color changes to amber (this may take up to 15 seconds).
4. Release the Control button. When the Status indicator changes to green (which may take up to 1 minute), the process is complete and the device has been reset. The unit now has the default IP address 192.168.0.90
5. Re-assign the IP address, for instructions see the Installation Guide supplied with the product.

Unit connectors

RS-232/485/422 connector – 5-pin terminal block for the RS-232/485/422 serial interface used to control auxiliary equipment. The port can be used in the following modes:

- 2TX/2RX RS-232 interface (RD, TD, RTS, CTS)
- Bidirectional RS-485 half-duplex port for data transmission using two wires, one combined RS/TX pair
- Bidirectional RS-485 full-duplex port for data transmission using four wires, one RX pair and one TX pair
- Unidirectional RS-422 port for transmitting and receiving data using two wires, RX- or TX pair
- Bidirectional RS-422 full-duplex port for data transmission (point-to-point) using four wires, one RX pair and one TX pair

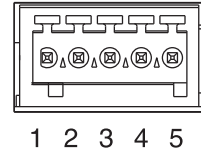

Note:

When using a long cable and high communication speeds it is recommended to insert a 120 ohm termination resistor between the RS-485 wires at both ends of the cable.

Function	Pin	Notes
RS-232 TD alt RS-485/422TX(B)	1	RS-232 Driver Output TX pair for RS-422 and 4-wire RS-485 (combined RX/TX pair for 2-wire RS-485)
RS-232 RTS alt RS-485/422TX(A)	2	
GND	3	Ground
RS-232 CTS alt RS-485/422RX(B)	4	RS-232 Receiver Input RX pair for all RS-485/422 modes
RS-232 RD alt RS-485/422RX(A)	5	

Audio 1:

Audio in (pink) – 3.5 mm input for a mono microphone, or a line-in mono signal (left channel is used from a stereo signal).

Audio out (green) – 3.5 mm output for audio (line level) that can be connected to a public address (PA) system or an active speaker with a built-in amplifier. A pair of headphones can also be attached. A stereo connector must be used for the audio out.

Audio 2:

Audio terminal block connector – 5-pin terminal block for connecting external audio equipment.

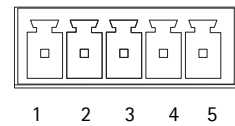

Function	Pin	Notes
MIC+	1	Microphone in
MIC-	2	Provides 48 V DC phantom power
GND	3	Ground
SPKR+	4	Speaker out with built-in amplifier
SPKR-	5	1 W RMS at 10% THD, min. 4 ohm

Gain – Controls the microphone in level (Audio 2). Use a screwdriver (2.5 mm flathead) to adjust the level.

Network connector – RJ-45 Ethernet connector. Supports Power over Ethernet (PoE class 3). Using shielded cables is recommended.

Power connector – 3-pin terminal block used for power input.

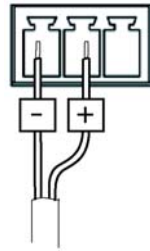

DC power input
8-34 V DC, max 8.2 W

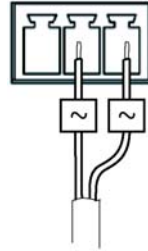

AC power input
20-24 V AC, max 13.7 VA

I/O terminal connectors A and B – Used in applications for e.g. event triggering and alarm notifications. In addition to an auxiliary power and a GND pin, each I/O terminal connector has 4 pins that can be configured as either input or output. These pins provide the interface to:

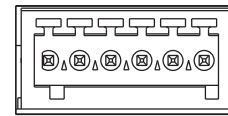

1 2 3 4 5 6

- Digital output – For connecting external devices such as relays and LEDs. Connected devices can be activated by the VAPIX® Application Programming Interface, output buttons on the Live View page or by an **Event Type**. The output will show as active (shown under **Ports & Devices > I/O Ports**) if the alarm device is activated.
- Digital input – An alarm input for connecting devices that can toggle between an open and closed circuit, for example: PIRs, door/window contacts, glass break detectors, etc. When a signal is received the state changes and the input becomes active (shown under **Ports & Devices > I/O Ports**, and, if enabled, on the Live View page).

Function	Pin	Notes	Specifications
GND	1	Ground	
3.3V DC Power	2	Can be used to power auxiliary equipment. Note: This pin can <u>only</u> be used as power out.	Max load = 250mA
Configurable (Input or Output)	3-6	Digital input – Connect to GND to activate, or leave floating (unconnected) to deactivate.	Min. input = -40V DC Max. input= +40V DC
		Digital output – Uses an open-drain NFET transistor with the source connected to GND. If used with an external relay, a diode must be connected in parallel with the load, for protection against voltage transients.	Max. load =100 mA Max. voltage = + 40V DC

Connection diagram

The following connection diagram gives an example of how to connect an auxiliary device to the I/O terminal connectors.

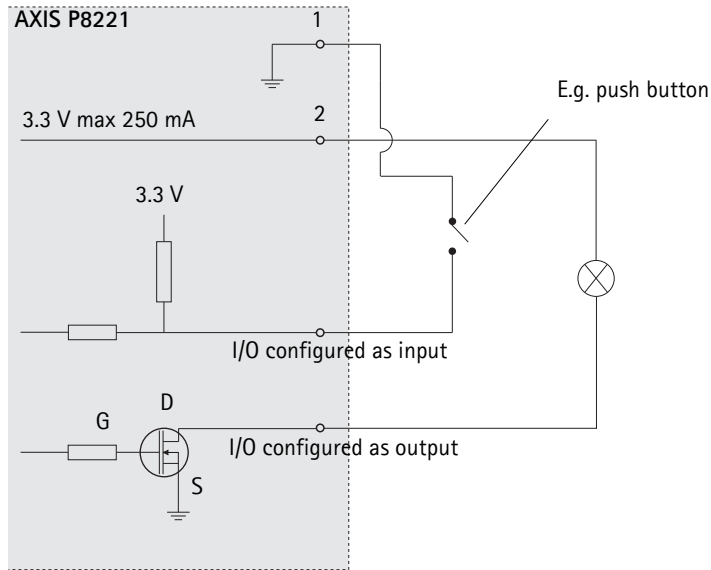

LED indicators

LED	Color	Indication
Mic level	Green	Microphone level signal between -20 dB and -3 dB
	Amber	Microphone level signal between -3 dB and -1 dB
	Red	Microphone level signal above -1 dB
Network	Green	Steady for connection to a 100 Mbit/s network. Flashes for network activity.
	Amber	Steady for connection to 10 Mbit/s network. Flashes for network activity.
	Unlit	No network connection.
Status	Green	Steady green for normal operation.
	Amber	Steady during startup, during reset to factory default or when restoring settings. Flashes while waiting to record.
	Red	Flashes while recording audio clips. Slow flash for failed upgrade.
Power	Green	Normal operation.
	Amber	Flashes green/amber during firmware upgrade.
Mic power	Amber	48 V DC phantom power on
	Unlit	48 V DC phantom power off

Note:

The microphone level LED can be enabled and disabled from Setup > Audio > Audio Settings.

Troubleshooting

Checking the firmware

Firmware is software that determines the functionality of network devices. One of your first actions when troubleshooting a problem should be to check the current firmware version. The latest version may contain a correction that fixes your particular problem. The current firmware version in your product is displayed on the page **Setup > About**.

Upgrading the firmware

When you upgrade AXIS P8221 with the latest firmware from Axis website, your product receives the latest functionality available. Always read the upgrade instructions and release notes available with each new release, before updating the firmware.

Note:

Preconfigured and customized settings are saved when the firmware is upgraded (providing the features are available in the new firmware) although this is not guaranteed by Axis Communications.

1. Save the firmware file to your computer. The latest version of the firmware is available free of charge from the Axis website at www.axis.com/techsup
2. Go to **Setup > System Options > Maintenance** in the product's web pages.
3. In the **Upgrade Server** section, browse to the desired firmware file on your computer. Click **Upgrade**.



Notes:

- After starting the upgrade process, always wait at least 5-10 minutes before restarting the product, even if you suspect the upgrade has failed.
- Your dealer reserves the right to charge for any repair attributable to faulty upgrading by the user.
- AXIS Camera Management can be used for multiple upgrades. Please see the Axis website at www.axis.com for more information.

Emergency Recovery Procedure

If power or the network connection to AXIS P8221 is lost during the upgrade, the process fails and the unit becomes unresponsive. A flashing red Status LED indicates a failed upgrade. To recover the unit, follow the steps below. The serial number is found on the label attached to the bottom of the unit.

1. **UNIX/Linux** - From the command line, type the following:

```
arp -s <IP address of unit> <serial number> temp
ping -s 408 <IP address of unit>
```

Windows - From a command/DOS prompt, type the following:

```
arp -s <IP address of unit> <serial number>
ping -l 408 -t <IP address of unit>
```

2. If the unit does not reply within a few seconds, restart it and wait for a reply. Press CTRL+C to stop Ping.
3. Open a browser and type in the unit's IP address. In the page that appears, use the **Browse** button to select the upgrade file to use, for example, **AXIS_P1343.bin**. Then click the **Load** button to restart the upgrade process.
4. After the upgrade is complete (1-10 minutes), the unit automatically restarts and shows a steady green on the Power and Status LEDs and flashing green or amber on the Network LED.
5. Reinstall the unit, referring to the installation guide.

If the emergency recovery procedure does not get the product up and running again, please contact Axis support at www.axis.com/techsup/

Axis Support

If you contact Axis support, please help us resolve your problem expediently by providing a Server Report and a detailed description of the problem.

The **Server Report** contains important information about the product and its software, as well as a list of the current parameters. The Access Log is also included in the Server Report. Go to **Setup > System Options > Support > Support Overview** to generate a Server Report.

Symptoms, possible causes, and remedial action

Problems setting the IP address	
When using ARP/Ping	Try the installation again. The IP address must be set within two minutes after power has been applied. Ensure the Ping length is set to 408. See the Installation Guide.
AXIS P8221 is located on a different subnet	If the IP address intended for the unit and the IP address of your computer are located on different subnets, you will not be able to set the IP address. Contact your network administrator to obtain an appropriate IP address.
The IP address is being used by another device	Disconnect the unit from the network. Run the Ping command. (In a Command/DOS window, type ping and the IP address of the unit). If you receive: Reply from <IP address>: bytes = 32; time = 10 ms..... - this means that the IP address may already be in use by another device on your network. You must obtain a new IP address and reinstall the unit. If you see: Request timed out - this means that the IP address is available for use with your unit. In this case, check all cabling and reinstall the unit.
Possible IP address conflict with another device on the same subnet	The static IP address in the unit is used before the DHCP server sets a dynamic address. This means that if the same default static IP address is also used by another device, there may be problems accessing the unit. To avoid this, set the static IP address to 0.0.0.0.
AXIS P8221 cannot be accessed from a browser	
Cannot log in	When HTTPS is enabled, ensure that the correct protocol (HTTP or HTTPS) is used when attempting to log in. You may need to manually type http or https in the browser's address field.
The IP address has been changed by DHCP	If the device and client are on the same network, Run AXIS IP Utility to locate the device. Identify the device using its model or serial number Alternatively: 1) Move the unit to an isolated network or to one with no DHCP or BOOTP server. Set the IP address again, using AXIS IP Utility (see the Installation Guide) or the ARP/Ping commands. 2) Access the unit and disable DHCP in the TCP/IP settings. Return the unit to the main network. The unit now has a fixed IP address that will not change.
Other networking problems	Test the network cable by connecting it to another network device, then Ping that device from your workstation. See instructions above.
AXIS P8221 is accessible locally, but not externally	
Broadband router configuration	To configure your broadband router to allow incoming data traffic to AXIS P8221, enable the NAT-traversal feature which will attempt to automatically configure the router to allow access to the device. This is enabled from Setup > System Options > Network > TCP/IP Advanced . Note that the router must support UPnP™.
Firewall protection	Check the Internet firewall with your system administrator.
Default routers required	Check if you need to configure the default router settings.
Problems with audio streaming	
No audio in the client	Make sure that AXIS Media Control (AMC) is installed on your workstation.
	Check that the correct network interface is selected in the AMC Control Panel (Streaming tab)
	Check that the relevant RTSP connection methods are enabled in the AMC Control Panel (Streaming tab).
No multicast audio in the client	Check with your network administrator that the multicast addresses used by the device are valid for your network.
	Check with your network administrator to see if there is a firewall preventing access.
Multicast audio only accessible by local clients	Check if your router supports multicasting, or if the router settings between the client and the server need to be configured. The TTL (Time To Live) value may need to be increased.
No audio	
Incorrect setup	Check the sound card in the PC. Ensure that the mute button is not pressed and the volume settings are correct.
No audio or very poor audio quality	Check that the correct Audio Input Port (Audio 1 or Audio 2) and Source (Microphone or Line) are selected under Setup > Audio > Audio Settings .
Audio volume too low/high	
Volume settings incorrect	The volume of the microphone is either too high or too low. Change the volume for the microphone in the toolbar on the Live View page.
Poor audio quality	
CPU overloaded	Reduce the number of clients.
Unsynchronized audio and video	It is recommended that the device's time setting is synchronized with an NTP Server. This is enabled under System Options > Date & Time .

Distorted audio (Audio 2)	Adjust the input gain, see page 13.
Echo	Feedback loops might appear in full-duplex mode. Try moving the microphone or the speaker, or use half-duplex mode instead.
The Power indicator is not constantly lit	
Faulty power supply	Check that you are using the same indoor power supply that came with the product.
The Status and Network indicator LEDs are flashing red rapidly	
Hardware failure	Contact your Axis reseller.
The Status indicator LED is flashing red and the product is inaccessible	
A firmware upgrade has been interrupted or the firmware has otherwise been damaged	See <i>Emergency Recovery Procedure</i> above.
Problems uploading files	
Limited space	There is only limited space available for the upload of your own files. Try deleting existing files to free up space.

For further assistance, please contact your reseller or see the support pages on Axis website at www.axis.com/techsup

Index

A

Active/Inactive 18, 20
 Administrator 12, 23
 Alarm 33
 AMC 6
 ARP/Ping 25
 Audio input 14
 Audio output 15
 Audio Settings 14
 AXIS Media Control 7, 14
 AXIS Media Control toolbar 8

B

Bonjour 6

C

CGI link 19
 Control Button 31

D

Date & Time 24
 Digital input 33
 Digital output 33
 DNS Configuration 26
 DNS Server 26
 Domain Name 26

E

Echo cancellation 14
 Emergency Recovery 35
 Enable ARP/Ping 25
 Event Servers 21
 Events 21

H

Host Name 26
 HTTP Server 21
 HTTPS 7, 23, 26

I

I/O connectors 33
 IEEE 802.1X 23
 Input 33
 Input port 17
 IP Address Filtering 23

L

Live View 6, 8
 Live View Config 19
 Logs & Reports 29

N

NAT traversal 6, 26
 Network Settings 25

NTP Server 24

O

Output 33
 Output Buttons 20
 Output port 17

P

Pulse 18, 20

Q

QoS (Quality of Service) 27

R

Recovery 35
 Restore 29
 RS-232/485/422 connector 32

S

Security 23
 Serial port 32
 Server Time 24
 SNMP 28
 Support 29
 System Options 23

T

TCP Server 21
 TCP/IP Settings 25
 Time Mode 24
 Troubleshooting 35

U

Upgrade Server 29
 UPnP 28
 Users 23

V

VAPIX 19