

AXIS P9106-V Network Camera

User Manual

AXIS P9106-V Network Camera

Table of Contents

Solution overview	3
Product overview	4
How to access the product	5
Setup	6
About the product's built-in help	6
Image quality	6
Overlays	8
Streaming and storage	9
Events	10
Applications	11
Add audio to your product	11
Troubleshooting	13
How to reset to factory default settings	13
How to check the current firmware	13
How to upgrade the firmware	13
Technical issues, clues and solutions	14
Performance considerations	15
Specifications	17
LED Indicators	17
SD card slot	17
Buttons	17
Connectors	18

AXIS P9106-V Network Camera

Solution overview

Solution overview

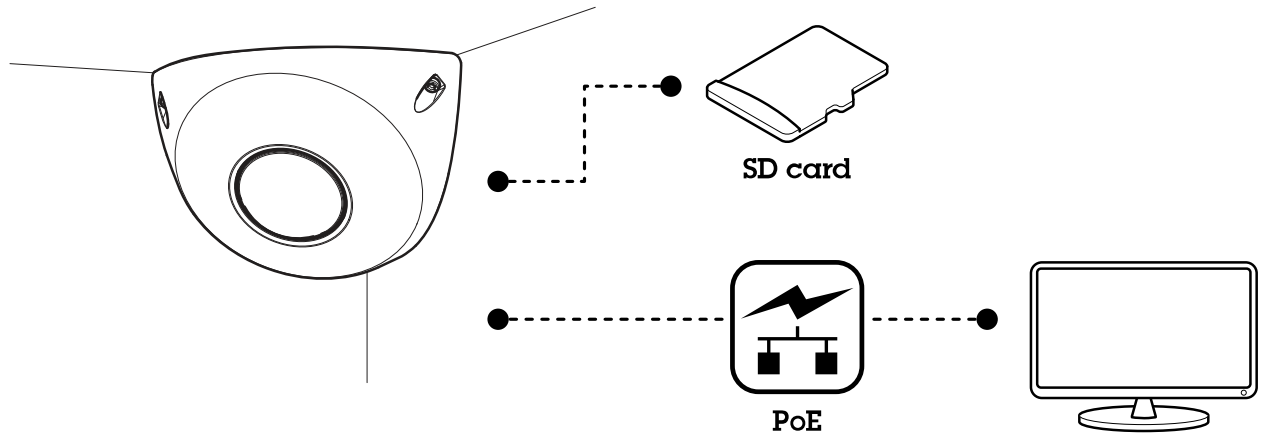

AXIS P9106-V Network Camera

Product overview

Product overview

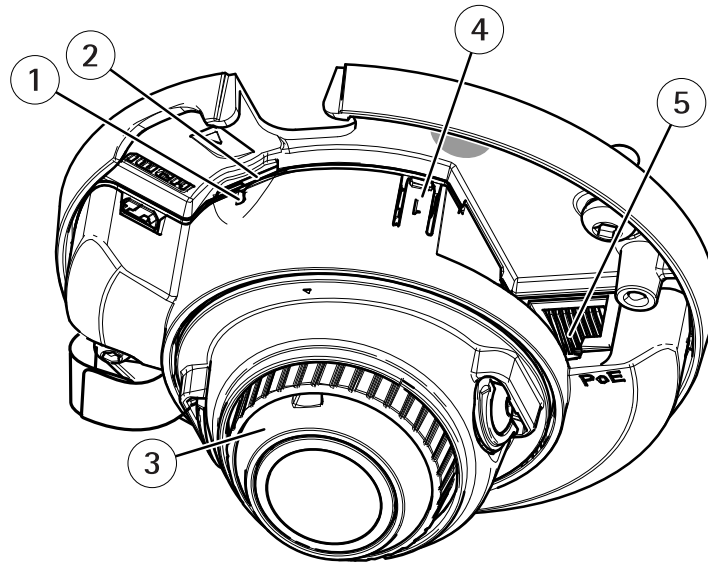

- 1 *Status LED*
- 2 *microSD card slot*
- 3 *Focus ring*
- 4 *Control button*
- 5 *Network connector (PoE)*

AXIS P9106-V Network Camera

How to access the product

How to access the product

AXIS IP Utility and AXIS Device Manager are recommended methods for finding Axis products on the network and assigning them IP addresses in Windows®. Both applications are free and can be downloaded from axis.com/support

The product can be used with the following browsers:

- Windows®: Chrome™ (recommended), Firefox®, Edge®, or Opera®
- OS X®: Chrome™ (recommended) or Safari®
- Other operating systems: Chrome™ or Firefox®.

If you need more information about recommended browsers, go to axis.com/browser-support

How to access the device from a browser

1. Start a web browser.
2. Enter the IP address or host name of the Axis device in the browser's address field.

To access the device from a Mac computer (OS X), go to Safari, click on Bonjour and select the device from the drop-down list. To add Bonjour as a browser bookmark, go to **Safari > Preferences**.

If you do not know the IP address, use AXIS IP Utility to locate the device on the network. For information about how to discover and assign an IP address, see the document *How to assign an IP address and access your device* on the device page at axis.com.

3. Enter your username and password. If this is the first time the device is accessed, the root password must first be configured, go to *Set a secure password for the root account on page 5*.
4. The device's live view page opens in your browser.

About secure passwords

Important

Axis devices send the initially set password in clear text over the network. To protect your device after the first login, set up a secure and encrypted HTTPS connection and then change the password.

The device password is the primary protection for the data and services. Axis devices do not impose a password policy as they may be used in various types of installations. To protect your data we recommend that you:

- Change the default password that comes with each device.
- Use a password with at least 8 characters, preferably created by a password generator.
- Don't expose the password.
- Change the password at a recurring interval, at least once a year.

Set a secure password for the root account

Important

The default administrator username is **root**. If the password for root is lost, reset the device to factory default settings.

1. Type a password. Follow the instructions about secure passwords. See *About secure passwords on page 5*.
2. Retype the password to confirm the spelling.
3. Click **Create login**. The password has now been configured.

AXIS P9106-V Network Camera

Setup

Setup

About the product's built-in help

You can access the built-in help from the product's webpage. The help provides more detailed information on the product's features and their settings.

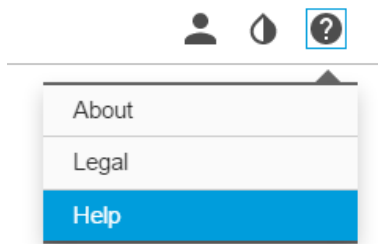

Image quality

How to select exposure mode

There are different exposure mode options in the camera that adjusts aperture, shutter speed, and gain to improve image quality for specific surveillance scenes. Go to **Settings > Image > Exposure** and select between the following exposure modes:

- For most use cases, select **Automatic** exposure.
- For environments with certain artificial lighting, for example fluorescent lighting, select **Flicker-free**.
- For environments with certain artificial light and bright light, for example outdoors with fluorescent lighting at night and sun during daytime, select **Flicker-reduced**.
- To lock the current exposure settings, select **Hold current**.

About view area

A view area is a cropped part of the full view. You can stream and store view areas instead of the full view to minimize bandwidth and storage needs. If you enable PTZ for a view area, you can pan, tilt and zoom within it. By using view areas you can remove parts of the full view, for example, the sky.

When you set up a view area, we recommend you to set the video stream resolution to the same size as or smaller than the view area size. If you set the video stream resolution larger than the view area size it implies digitally scaled up video after sensor capture, which requires more bandwidth without adding image information.

How to hide parts of the image with privacy masks

What is a privacy mask?

A privacy mask is a user-defined area that prevents users from viewing a part of the monitored area. In the video stream, privacy masks appear as blocks of solid color.

You'll see the privacy mask on all snapshots, recorded video, and live streams.

You can use the VAPIX® application programming interface (API) to turn off the privacy masks.

Important

Using multiple privacy masks may affect the product's performance.

AXIS P9106-V Network Camera

Setup

How to create a privacy mask

To create a privacy mask, go to **Settings > Privacy mask**.

How to enhance facial recognition

To better recognize the face of a person passing by the camera, you can set the optimal pixel resolution with the camera's pixel counter.

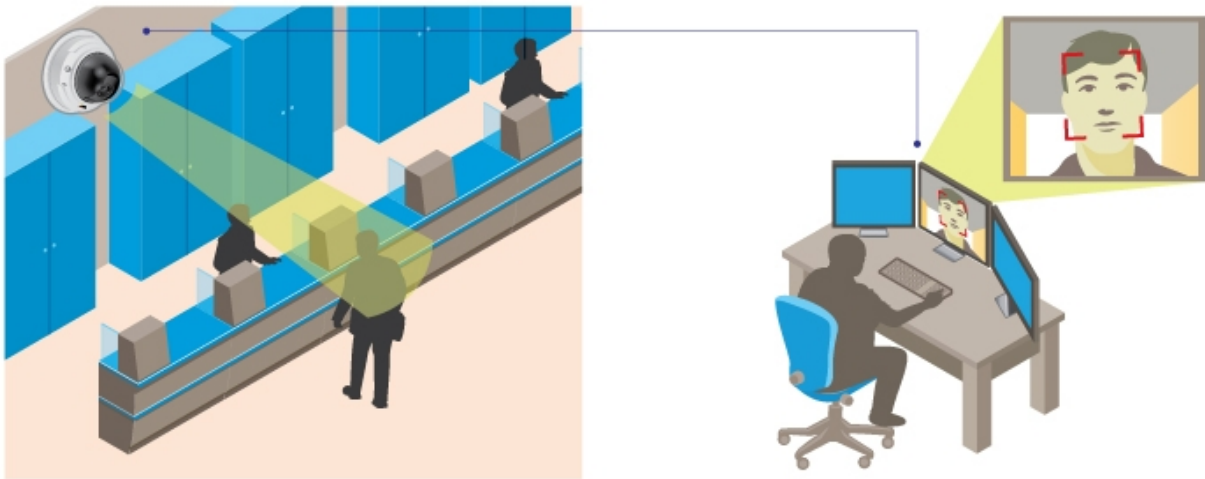

1. Go to **Settings > System > Orientation** and click .
2. Adjust the size and placement of the rectangle in the camera's live view around the area of interest, for example where the faces of passing persons are expected to appear. You can then see the number of pixels represented by the sides of the rectangle.

Note

You can use an object of a known size in the view as a reference to decide how much resolution is needed for recognition.

How to reduce noise in low-light conditions

To reduce noise in low-light conditions, you can adjust one or more of the following settings:

- Make sure that the exposure mode is automatic.

Note

Increasing the max shutter value can result in motion blur.

- The shutter speed should be as slow as possible, which means you should set max shutter to the highest possible value.
- Reduce sharpness in the image.

AXIS P9106-V Network Camera

Setup

How to handle scenes with strong backlight



Image without WDR.

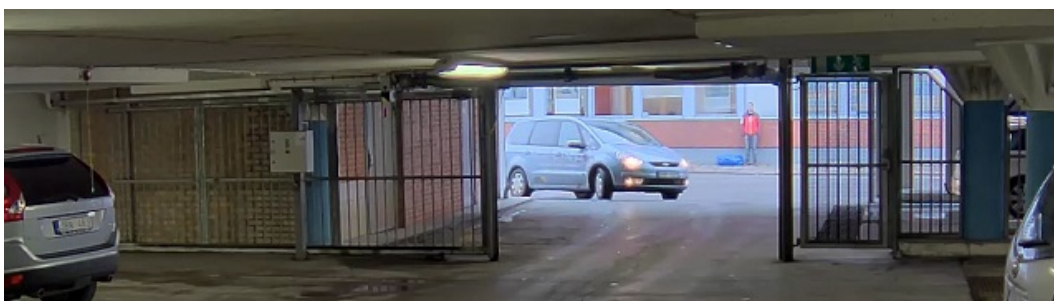

Image with WDR.

Note

WDR may cause artifacts in the image.

Find out more about WDR and how to use it at axis.com/web-articles/wdr

How to maximize details in an image

Important

If you maximize details in an image, the bitrate will probably increase and you might get a reduced frame rate.

- Make sure to select the capture mode that has the highest resolution.
- Set the compression as low as possible.
- Select MJPEG streaming.
- Turn off Zipstream functionality.

Overlays

About overlays

Overlays are superimposed over the video stream. They are used to provide extra information during recordings, such as a timestamp, or during product installation and configuration.

How to show a text overlay when the camera detects motion

This example explains how to display the text "Motion detected" when the camera detects motion:

AXIS P9106-V Network Camera

Setup

Make sure the AXIS Video Motion Detection application is running:

1. Go to **Settings > Apps > AXIS Video Motion Detection**.
2. Start the application if it is not already running.
3. Make sure you have set up the application according to your needs.

Add the overlay text:

4. Go to **Settings > Overlay**.
5. Enter #D in the text field.
6. Choose text size and appearance.

Create an action rule:

7. Go to **System > Events > Action rules**.
8. Create an action rule with **AXIS Video Motion Detection** as trigger.
9. From the list of actions, select **Overlay text**.
10. Type "Motion detected".
11. Set the duration.

Streaming and storage

How to choose video compression format

Decide which compression method to use based on your viewing requirements, and on the properties of your network. The available options are:

Motion JPEG

Motion JPEG or MJPEG is a digital video sequence that is made up of a series of individual JPEG images. These images are then displayed and updated at a rate sufficient to create a stream that shows constantly updated motion. For the viewer to perceive motion video the rate must be at least 16 image frames per second. Full motion video is perceived at 30 (NTSC) or 25 (PAL) frames per second.

The Motion JPEG stream uses considerable amounts of bandwidth, but provides excellent image quality and access to every image contained in the stream.

H.264 or MPEG-4 Part 10/AVC

Note

H.264 is a licensed technology. The Axis product includes one H.264 viewing client license. Installing additional unlicensed copies of the client is prohibited. To purchase additional licenses, contact your Axis reseller.

H.264 can, without compromising image quality, reduce the size of a digital video file by more than 80% compared to the Motion JPEG format and by as much as 50% compared to the MPEG-4 standard. This means that less network bandwidth and storage space are required for a video file. Or seen another way, higher video quality can be achieved for a given bitrate.

How to reduce bandwidth and storage

Important

If you reduce the bandwidth it can result in loss of details in the picture.

1. Go to live view and select **H.264**.

AXIS P9106-V Network Camera

Setup

2. Go to **Settings > Stream**.
3. Do one or more of the following:
 - Turn on the Zipstream functionality and select the desired level.
 - Turn on dynamic GOP and set a high GOP length value.
 - Increase the compression.
 - Turn on dynamic FPS.

How to set up network storage

To store recordings on the network, you need to set up network storage:

1. Go to **Settings > System > Storage**.
2. Click **Setup** under **Network storage**.
3. Enter the IP address of the host server.
4. Enter the name of the shared location on the host server.
5. Move the switch if the share requires a login, and enter username and password.
6. Click **Connect**.

Events

About events

The event pages allow you to configure your product to perform actions when different events occur. For example, the product can start a recording or send an email notification when motion is detected. The set of conditions that defines how and when the action is triggered is called an action rule.

How to trigger an action

1. Go to **Settings > System > Events** to set up an action rule. The action rule defines when the camera will perform certain actions. Action rules can be setup as scheduled, recurring, or for example, triggered by motion detection.
2. Select what **Trigger** must be met to trigger the action. If you specify more than one trigger for the action rule, all of them must be met to trigger the action.
3. Select which **Action** the camera should perform when the conditions are met.

Note

If you make changes to an active action rule, the action rule needs to be restarted for the changes to take effect.

How to record video when the camera detects motion

This example explains how to set up the camera to start recording to the SD card five seconds before it detects motion and to stop one minute after.

Make sure the AXIS Video Motion Detection application is running:

1. Go to **Settings > Apps > AXIS Video Motion Detection**.
2. Start the application if it is not already running.
3. Make sure you have set up the application according to your needs.

AXIS P9106-V Network Camera

Setup

Create an action rule:

4. Go to **Settings > System > Events** and add an action rule.
5. Type a name for the action rule.
6. From the list of triggers, select **Applications** and then select **AXIS Video Motion Detection (VMD)**.
7. From the list of actions, select **Record video**.
8. Select an existing stream profile or create a new one.
9. Enable and set the pre-trigger time to 5 seconds.
10. Enable **While the rule is active**.
11. Enable and set the post-trigger time to 60 seconds.
12. Select **SD card** from the list of storage options.
13. Click **Ok**.

Applications

About applications

AXIS Camera Application Platform (ACAP) is an open platform that enables third parties to develop analytics and other applications for Axis products. To find out more about available applications, downloads, trials and licenses, go to axis.com/applications

To find the user manuals for Axis applications, go to axis.com

Note

- Several applications can run at the same time but some applications might not be compatible with each other. Certain combinations of applications might require too much processing power or memory resources when run in parallel. Verify that the applications work together before deployment.

Add audio to your product

Add audio capability to your product

Even though your Axis network video product has no built-in audio capability, it is still possible to add this functionality, by using a product from the AXIS T61 Series Audio and I/O Interface (supplied separately), which effectively provides microphone capability where it does not exist.

This setup requires the AXIS T61 Series product (2) to be connected between your Axis network video device (1) and the PoE switch (3) providing power.

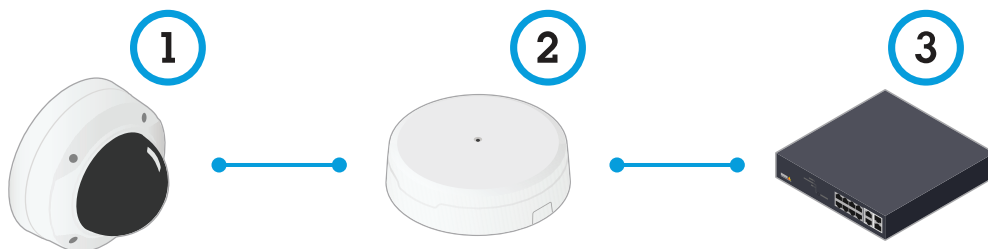

AXIS P9106-V Network Camera

Setup

Once the various devices are correctly connected, there will be an audio tab in the settings for your Axis network video product.

The AXIS T61 Series product can be used to good effect in situations such as interview rooms. The Axis network video product is mounted on the wall or ceiling to give good visual coverage, while the AXIS T61 Series product can be mounted, for example, on or above the interview table.

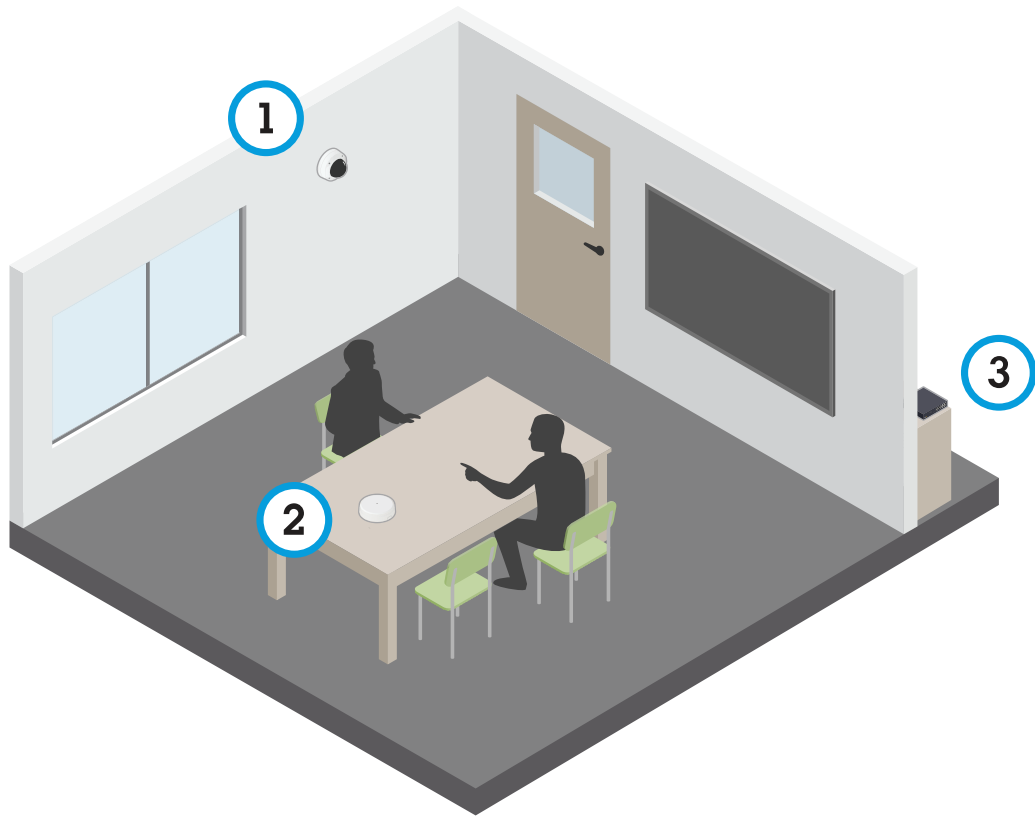

AXIS P9106-V Network Camera

Troubleshooting

Troubleshooting

If you can't find what you're looking for here, try the troubleshooting section at axis.com/support

How to reset to factory default settings

Important

Reset to factory default should be used with caution. A reset to factory default resets all settings, including the IP address, to the factory default values.

To reset the product to the factory default settings:

1. Disconnect power from the product.
2. Press and hold the control button while reconnecting power. See *Product overview on page 4*.
3. Keep the control button pressed for 15–30 seconds until the status LED indicator flashes amber.
4. Release the control button. The process is complete when the status LED indicator turns green. The product has been reset to the factory default settings. If no DHCP server is available on the network, the default IP address is 192.168.0.90
5. Use the installation and management software tools to assign an IP address, set the password, and access the video stream.

The installation and management software tools are available from the support pages on axis.com/support

It is also possible to reset parameters to factory default through the web interface. Go to **Settings > System > Maintenance** and click **Default**.

How to check the current firmware

Firmware is the software that determines the functionality of network devices. One of your first actions when troubleshooting a problem should be to check the current firmware version. The latest version may contain a correction that fixes your particular problem.

To check the current firmware:

1. Go to the product's webpage.
2. Click on the help menu. 
3. Click **About**.

How to upgrade the firmware

Important

Preconfigured and customized settings are saved when the firmware is upgraded (provided that the features are available in the new firmware) although this is not guaranteed by Axis Communications AB.

Important

Make sure the product remains connected to the power source throughout the upgrade process.

Note

When you upgrade the product with the latest firmware, the product receives the latest functionality available. Always read the upgrade instructions and release notes available with each new release before upgrading the firmware. To find the latest firmware and the release notes, go to axis.com/support/firmware

AXIS P9106-V Network Camera

Troubleshooting

1. Download the latest firmware file to your computer, available free of charge at axis.com/support/firmware
2. Log in to the product as an administrator.
3. Go to **Settings > System > Maintenance**. Follow the instructions on the page. When the upgrade has finished, the product restarts automatically.

AXIS Device Manager can be used for multiple upgrades. Find out more at axis.com/products/axis-device-manager

Technical issues, clues and solutions

If you can't find what you're looking for here, try the troubleshooting section at axis.com/support

Problems upgrading the firmware

Firmware upgrade failure	If the firmware upgrade fails, the product reloads the previous firmware. The most common reason is that the wrong firmware file has been uploaded. Check that the name of the firmware file corresponds to your product and try again.
--------------------------	---

Problems setting the IP address

The product is located on a different subnet	If the IP address intended for the product and the IP address of the computer used to access the product are located on different subnets, you cannot set the IP address. Contact your network administrator to obtain an IP address.
--	---

The IP address is being used by another device	Disconnect the Axis product from the network. Run the ping command (in a Command/DOS window, type <code>ping</code> and the IP address of the product): <ul style="list-style-type: none">• If you receive: <code>Reply from <IP address>: bytes=32; time=10...</code> this means that the IP address may already be in use by another device on the network. Obtain a new IP address from the network administrator and reinstall the product.• If you receive: <code>Request timed out</code>, this means that the IP address is available for use with the Axis product. Check all cabling and reinstall the product.
--	---

Possible IP address conflict with another device on the same subnet	The static IP address in the Axis product is used before the DHCP server sets a dynamic address. This means that if the same default static IP address is also used by another device, there may be problems accessing the product.
---	---

The product cannot be accessed from a browser

Cannot log in	When HTTPS is enabled, ensure that the correct protocol (HTTP or HTTPS) is used when attempting to log in. You may need to manually type <code>http</code> or <code>https</code> in the browser's address field.
---------------	--

If the password for the user `root` is lost, the product must be reset to the factory default settings. See *How to reset to factory default settings on page 13*.

The IP address has been changed by DHCP	IP addresses obtained from a DHCP server are dynamic and may change. If the IP address has been changed, use AXIS IP Utility or AXIS Device Manager to locate the product on the network. Identify the product using its model or serial number, or by the DNS name (if the name has been configured).
---	--

If required, a static IP address can be assigned manually. For instructions, go to axis.com/support

Certificate error when using IEEE 802.1X	For authentication to work properly, the date and time settings in the Axis product must be synchronized with an NTP server. Go to Settings > System > Date and time
--	---

The product is accessible locally but not externally

Router configuration	Check that your router allows incoming data traffic to the Axis product. The router must support UPnP®.
----------------------	---

Firewall protection	Check the Internet firewall with your network administrator.
---------------------	--

AXIS P9106-V Network Camera

Troubleshooting

Problems with streaming

Multicast H.264 only accessible by local clients	Check if your router supports multicasting, or if the router settings between the client and the product need to be configured. The TTL (Time To Live) value may need to be increased.
No multicast H.264 displayed in the client	Check with your network administrator that the multicast addresses used by the Axis product are valid for your network. Check with your network administrator to see if there is a firewall preventing viewing.
Poor rendering of H.264 images	Ensure that your graphics card is using the latest driver. The latest drivers can usually be downloaded from the manufacturer's website.
Color saturation is different in H.264 and Motion JPEG	Modify the settings for your graphics adapter. Go to the adapter's documentation for more information.
Lower frame rate than expected	<ul style="list-style-type: none">• See <i>Performance considerations on page 15</i>.• Reduce the number of applications running on the client computer.• Limit the number of simultaneous viewers.• Check with the network administrator that there is enough bandwidth available.• Lower the image resolution.• Log in to the product's webpage and set a capture mode that prioritizes frame rate. Changing the capture mode to prioritize frame rate might lower the maximum resolution depending on the product used and capture modes available.• The maximum frames per second is dependent on the utility frequency (60/50 Hz) of the Axis product.

Problems retrieving additional video streams

'Video Error' displayed in AXIS Companion, or	<p>This camera is designed to deliver up to four different streams. If a fifth unique stream is requested, the camera will not be able to provide it, and an error message is displayed. The error message depends on the way the stream is requested. The streams are used on a first come, first served basis. Examples of instances using a stream are:</p> <ul style="list-style-type: none">• Live viewing in a web browser or other application• While recording – continuous or motion triggered recording• An event using images on the camera, for example an event sending an e-mail with an image every hour• An installed and running application, such as AXIS Video Motion Detection, will always consume a video stream, whether it is used or not. A stopped application does not consume a video stream. <p>The camera can deliver more than four simultaneous streams provided the configuration of any additional stream is identical to any of the first four streams. Identical configuration implies exactly the same resolution, frame rate, compression, video format, rotation etc. For more information see the white paper "Max number of unique video stream configurations", available at axis.com</p>
'Stream: Error. Something went wrong. Maybe there are too many viewers.' in Chrome/Firefox, or	
'503 service unavailable' error in Quick Time, or	
'Camera not available' displayed in AXIS Camera Station, or	
'Error reading video stream' message in browser when using the Java applet	

Performance considerations

When setting up your system, it is important to consider how various settings and situations affect the performance. Some factors affect the amount of bandwidth (the bitrate) required, others can affect the frame rate, and some affect both. If the load on the CPU reaches its maximum, this also affects the frame rate.

The following factors are the most important to consider:

- High image resolution or lower compression levels result in images containing more data which in turn affects the bandwidth.
- Rotating the lens manually will result in better performance compared to rotating the image from the GUI.
- Access by large numbers of Motion JPEG or unicast H.264 clients affects the bandwidth.

AXIS P9106-V Network Camera

Troubleshooting

- Simultaneous viewing of different streams (resolution, compression) by different clients affects both frame rate and bandwidth.

Use identical streams wherever possible to maintain a high frame rate. Stream profiles can be used to ensure that streams are identical.

- Accessing Motion JPEG and H.264 video streams simultaneously affects both frame rate and bandwidth.
- Heavy usage of event settings affects the product's CPU load which in turn affects the frame rate.
- Using HTTPS may reduce frame rate, in particular if streaming Motion JPEG.
- Heavy network utilization due to poor infrastructure affects the bandwidth.
- Viewing on poorly performing client computers lowers perceived performance and affects frame rate.
- Running multiple AXIS Camera Application Platform (ACAP) applications simultaneously may affect the frame rate and the general performance.

AXIS P9106-V Network Camera

Specifications

Specifications

To find the latest version of the product's datasheet, go to the product page at axis.com and locate **Support & Documentation**.

LED Indicators

Note

- The Status LED can be configured to flash while an event is active.
- The Status LED can be configured to flash for identifying the unit. Go to **Settings > System > Plain config**.

Status LED	Indication
Unlit	Connection and normal operation.
Green	Shows steady green for 10 seconds for normal operation after startup completed.
Amber	Steady during startup. Flashes during firmware upgrade or reset to factory default.
Amber/Red	Flashes amber/red if network connection is unavailable or lost.
Red	Firmware upgrade failure.

Note

Amber is a combination of red and green, and can be perceived as either of these colors depending on viewing angle.

SD card slot

NOTICE

- Risk of damage to SD card. Do not use sharp tools, metal objects, or excessive force when inserting or removing the SD card. Use your fingers to insert and remove the card.
- Risk of data loss and corrupted recordings. Do not remove the SD card while the product is running. Unmount the SD card from the product's webpage before removal.

This product supports microSD/microSDHC/microSDXC cards.

For SD card recommendations, see axis.com



microSD, microSDHC, and microSDXC Logos are trademarks of SD-3C LLC. microSD, microSDHC, microSDXC are trademarks or registered trademarks of SD-3C, LLC in the United States, other countries or both.

Buttons

Control button

The control button is used for:

- Resetting the product to factory default settings. See *How to reset to factory default settings on page 13*.
- Connecting to an AXIS Video Hosting System service. To connect, press and hold the button for about 3 seconds until the status LED flashes green.

AXIS P9106-V Network Camera

Specifications

Connectors

HDMI Connector

The HDMI™ connector is not used by this product and it is not possible to get a video stream from it.

Network connector

RJ45 Ethernet connector with Power over Ethernet (PoE).

