

## **AXIS Q6154-E PTZ Dome Network Camera**

## **User Manual**

# AXIS Q6154-E PTZ Dome Network Camera

## Table of Contents

---

<b>Product overview</b> .....	3
<b>How to access the product</b> .....	4
How to access the product from a browser .....	4
About secure passwords .....	4
<b>Setup</b> .....	6
Product webpage overview .....	6
Image quality .....	8
Privacy masks .....	10
Overlays .....	10
PTZ (Pan Tilt Zoom) .....	11
Streaming and storage .....	12
Events .....	13
Applications .....	14
<b>Troubleshooting</b> .....	15
How to reset to factory default settings .....	15
How to check the current firmware .....	15
How to upgrade the firmware .....	15
Technical issues, clues and solutions .....	16
Performance considerations .....	17
<b>Specifications</b> .....	18
LED indicators .....	18
SD card slot .....	18
Buttons .....	18
Connectors .....	18

# AXIS Q6154-E PTZ Dome Network Camera

## Product overview

---

### Product overview

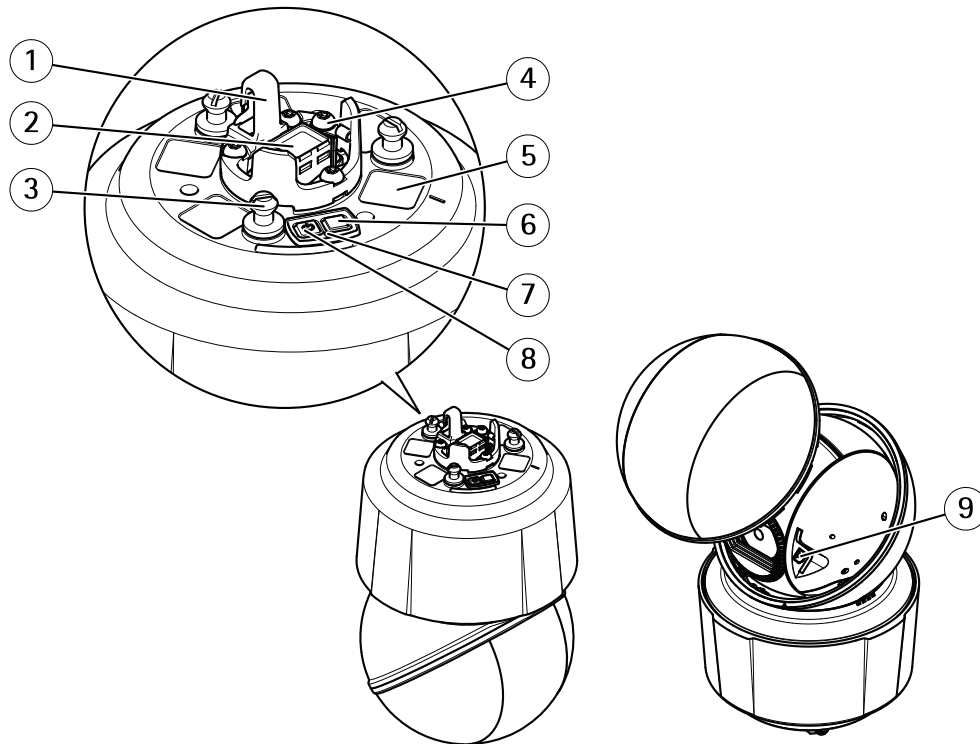

- 1 Hook for safety wire
- 2 Network connector
- 3 Unit holder (3x)
- 4 Ground screw
- 5 Part number (P/N) & Serial number (S/N)
- 6 Control button
- 7 Status LED indicator
- 8 Power button
- 9 SD card slot

# AXIS Q6154–E PTZ Dome Network Camera

## How to access the product

---

### How to access the product

AXIS IP Utility and AXIS Device Manager are recommended methods for finding Axis products on the network and assigning them IP addresses in Windows®. Both applications are free and can be downloaded from [axis.com/support](https://axis.com/support)

The product can be used with the following browsers:

- Windows®: Chrome™ (recommended), Firefox®, Edge®, or Opera®
- OS X®: Chrome™ (recommended) or Safari®
- Other operating systems: Chrome™ or Firefox®.

If you need more information about recommended browsers, go to [axis.com/browser-support](https://axis.com/browser-support)

### How to access the product from a browser

1. Start a web browser.
2. Enter the IP address or host name of the Axis product in the browser's address field.

To access the product from a Mac computer (OS X), go to Safari, click on Bonjour and select the product from the drop-down list. To add Bonjour as a browser bookmark, go to **Safari > Preferences**.

If you do not know the IP address, use AXIS IP Utility to locate the product on the network. For information about how to discover and assign an IP address, see the document *How to assign an IP address and access your device* on the product page at [axis.com](https://axis.com).

3. Enter your username and password. If this is the first time the product is accessed, the root password must first be configured.
4. The product's live view page opens in your browser.

### About secure passwords

#### Important

Axis devices send the initially set password in clear text over the network. To protect your device after the first login, set up a secure and encrypted HTTPS connection and then change the password.

The device password is the primary protection for the data and services. Axis devices do not impose a password policy as they may be used in various types of installations. To protect your data we recommend that you:

- Change the default password that comes with each device.
- Use a password with at least 8 characters, preferably created by a password generator.
- Don't expose the password.
- Change the password at a recurring interval, at least once a year.

### Set a secure password for the root account

#### Important

The default administrator username is **root**. If the password for root is lost, reset the device to factory default settings.

1. Type a password. Follow the instructions about secure passwords. See *About secure passwords* on page 4.
2. Retype the password to confirm the spelling.

# AXIS Q6154-E PTZ Dome Network Camera

## How to access the product

---

3. Click **Create login**. The password has now been configured.

# AXIS Q6154-E PTZ Dome Network Camera

## Setup

---

### Setup

#### Product webpage overview



- 1 *Live view control bar*
- 2 *Live view*
- 3 *Product name*
- 4 *Controls*
- 5 *Video control bar*
- 6 *Settings toggle*

# AXIS Q6154-E PTZ Dome Network Camera

## Setup

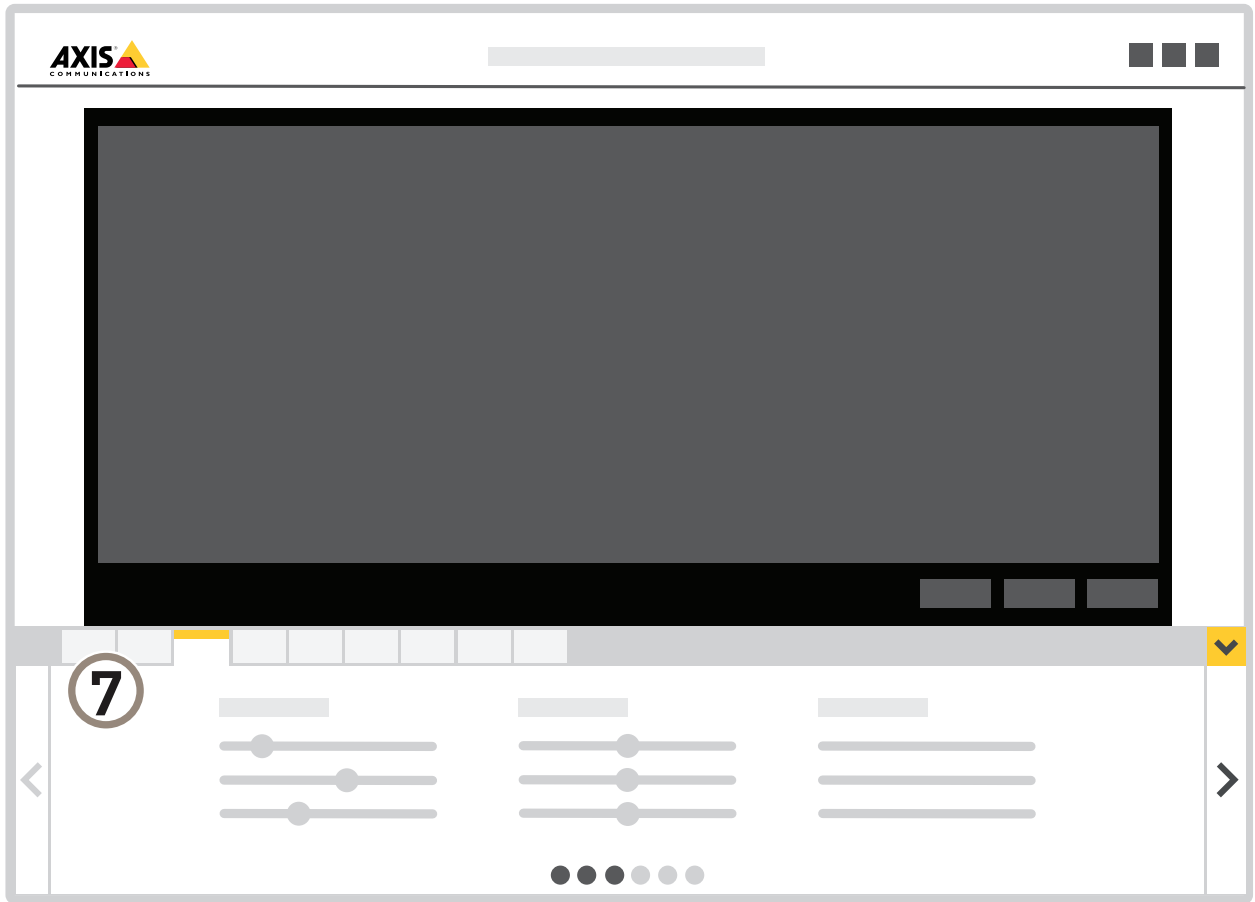

7 Settings tabs

### About the product's built-in help

You can access the built-in help from the product's webpage. The help provides more detailed information on the product's features and their settings.

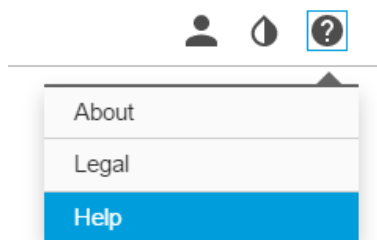

# AXIS Q6154-E PTZ Dome Network Camera

## Setup

---

### Image quality

#### How to benefit from IR light in low-light conditions using night mode

Your camera uses visible light to deliver color images during the day. As light diminishes, you can set the camera to automatically shift to night mode. In night mode the camera uses both visible light and near-infrared light to deliver black-and-white images. Since the camera uses more of the available light it can deliver brighter, more detailed, images.

1. Go to **Settings > Image > Day and night**, and make sure that the **IR cut filter** is set to **Auto**.
2. To determine at what light level you want the camera to shift to night mode, move the **Threshold** slider toward **Bright** or **Dark**.

#### Note

If you set the shift to occur when it's brighter, the image remains sharper as there will be less low-light noise. If you set the shift to occur when it's darker, the image colors are maintained longer but there will be more image blur due to low-light noise.

#### How to handle scenes with strong backlight

Dynamic range is the difference in light levels in an image. In some cases the difference between the darkest and the brightest areas can be significant. The result is often an image where either the dark or the bright areas are visible. Wide dynamic range (WDR) makes both dark and bright areas of the image visible.

1. Go to **Settings > Image**.
2. Turn on WDR under **Wide dynamic range**.



*Image without WDR.*



*Image with WDR.*

#### Note

WDR may cause artifacts in the image.

Find out more about WDR and how to use it at [axis.com/web-articles/wdr](https://axis.com/web-articles/wdr)



# AXIS Q6154-E PTZ Dome Network Camera

## Setup

---

### How to stabilize a shaky image with Electronic Image Stabilization (EIS)

EIS can be used in environments where the product is mounted in an exposed location and subject to vibrations, for example, wind or passing traffic. Turn on EIS to get a smoother and steadier image without blur.

EIS also reduces the file size of the compressed image and lowers the bitrate of the video stream.

#### Note

When EIS is turned on the image is cropped slightly, lowering the maximum resolution.

1. Go to Settings > Image.
2. Turn on EIS.

### About laser focus

The laser focus feature includes a laser that assists focusing by providing a reference point. This means laser focus helps cameras find focus faster than cameras that only have autofocus. It finds focus in challenging lighting conditions, such as scenes with low light or contrast. You get the best focus in the center of the image.

The focus performance depends on the weather conditions, the cleanness of the dome, and the reflection value of the object. For example, a mirror or a window can distract the laser. In situations with insufficient object reflections, the camera only uses the autofocus.



*With moving objects and scenes that change quickly, laser focus finds focus instantly, making it possible to focus, for example, on the license plate of a moving vehicle.*

The laser focus is always enabled. As soon as the camera is turned on, the laser focus starts working.

### How to increase image quality in rainy weather with speed dry

The speed dry function helps to provide sharp images in rainy weather. It can also simplify dome cleaning, allowing for more efficient methods such as high pressure cleaning. With the speed dry function activated, the dome vibrates at high speed. It breaks the surface tension of the water and removes the drips.

# AXIS Q6154-E PTZ Dome Network Camera

## Setup

---



Snapshot from a camera's live view before and after speed dry has been activated.

1. Click on the **Speed dry** button in the Live view control bar.

## Privacy masks

### How to hide parts of the image with privacy masks

What is a privacy mask?

A privacy mask is a user-defined area that prevents users from viewing a part of the monitored area. In the video stream, privacy masks appear as blocks of solid color.

The privacy mask is relative to the pan, tilt, and zoom coordinates, so regardless of where you point the camera, the privacy mask covers the same place or object.

You'll see the privacy mask on all snapshots, recorded video, and live streams.

You can use the VAPIX® application programming interface (API) to turn off the privacy masks.

#### Important

Using multiple privacy masks may affect the product's performance.

#### How to create a privacy mask

To create a privacy mask, go to **Settings > Privacy mask**.

## Overlays

### About overlays

Overlays are superimposed over the video stream. They are used to provide extra information during recordings, such as a timestamp, or during product installation and configuration.

### How to display the pan or tilt position as a text overlay

It may be useful to retrieve, for instance from a recorded video, the pan or tilt position in degrees in which an event has taken place. This can be obtained by including the position in the image as a text overlay, using a so-called modifier.

1. Go to **Settings > Overlay**.
2. In the text field, enter #*x* to show the pan position.  
Enter #*y* to show the tilt position.

# AXIS Q6154-E PTZ Dome Network Camera

## Setup

---

3. Choose alignment, text size and appearance.
4. Include the text overlay.
5. The current pan and tilt positions show up in the live view image and in the recording.

### PTZ (Pan Tilt Zoom)

#### How to limit pan, tilt, and zoom movements

In this example, the camera is surveilling a parking lot with nearby apartment buildings. Set pan, tilt and zoom limits to ensure privacy for residents.

To limit pan, tilt and zoom movements, go to **Settings > PTZ > Limits**.

#### About guard tours



A guard tour displays the video stream from different preset positions either in a predetermined or random order, and for configurable periods of time. Once started, a guard tour continues to run until stopped, even when there are no clients (web browsers) viewing the images.

The guard tour function in this product includes tour recording. This allows recording a custom tour using an input device, such as a joystick, a mouse or a keyboard, or through using the VAPIX® Application Programming Interface (API). A recorded tour is a replay of a recorded sequence of pan/tilt/zoom movements, including their variable speeds and lengths.

#### How to create a guard tour with preset positions

1. Go to **Settings > PTZ > Guard tours**
2. Click **+**.
3. Select **Preset position**.
4. To edit the guard tour's properties, click 
5. Type a name for the guard tour and specify the pause length in minutes between each tour.
6. If you want the guard tour to go to the preset positions in a random order, turn on **Shuffle**.
7. Click **Done**.
8. Click **Add** to add the preset positions that you want in your guard tour.
9. Click **Done** to exit the guard tour settings.
10. To schedule the guard tour, go to **System > Events**.

#### How to create a recorded guard tour

1. Go to **Settings > PTZ > Guard tours**
2. Click **+**
3. Select **Recorded**.
4. To start recording the pan/tilt/zoom movements, click 
5. When you're satisfied, click 
6. If you re-record the guard tour you will overwrite the existing recorded guard tour.

# AXIS Q6154-E PTZ Dome Network Camera

## Setup

---

7. To edit the guard tour's properties, click .
8. Type a name for the guard tour and specify the pause length in minutes between each tour.
9. Click **Done** twice to exit the guard tour settings.
10. To schedule the guard tour, go to **System > Events**.

### About autotracking

Autotracking detects movement in the camera's field of view, for example a moving vehicle or person, and follows the moving object until it stops or disappears from the monitored area. In case there is much simultaneous movement, the product selects the area with the most amount of motion. When there are no moving objects in the field of view, the camera returns to the home position.

#### Important

- The autotracking feature is designed for areas where there is a limited amount of movement.
- If both autotracking and guard tour are enabled, we recommend using the PTZ control queue. In the control queue, guard tour has lower priority than autotracking, preventing the product from stopping autotracking to maintain or start a guard tour.
- Autotracking does not follow object behind privacy masks or objects in exclude areas. You can also set up maximum limits so that the autotracking only triggers within a certain range in the live view.

## Streaming and storage

### How to choose video compression format

Decide which compression method to use based on your viewing requirements, and on the properties of your network. The available options are:

#### Motion JPEG

Motion JPEG or MJPEG is a digital video sequence that is made up of a series of individual JPEG images. These images are then displayed and updated at a rate sufficient to create a stream that shows constantly updated motion. For the viewer to perceive motion video the rate must be at least 16 image frames per second. Full motion video is perceived at 30 (NTSC) or 25 (PAL) frames per second.

The Motion JPEG stream uses considerable amounts of bandwidth, but provides excellent image quality and access to every image contained in the stream.

#### H.264 or MPEG-4 Part 10/AVC

#### Note

H.264 is a licensed technology. The Axis product includes one H.264 viewing client license. Installing additional unlicensed copies of the client is prohibited. To purchase additional licenses, contact your Axis reseller.

H.264 can, without compromising image quality, reduce the size of a digital video file by more than 80% compared to the Motion JPEG format and by as much as 50% compared to the MPEG-4 standard. This means that less network bandwidth and storage space are required for a video file. Or seen another way, higher video quality can be achieved for a given bitrate.

### How to reduce bandwidth and storage

#### Important

If you reduce the bandwidth it can result in loss of details in the picture.

1. Go to live view and select **H.264**.
2. Go to **Settings > Stream**.
3. Do one or more of the following:

# AXIS Q6154-E PTZ Dome Network Camera

## Setup

---

- Turn on the Zipstream functionality and select the desired level.
- Turn on dynamic GOP and set a high GOP length value.
- Increase the compression.
- Turn on dynamic FPS.

## Events

### About events

The event pages allow you to configure your product to perform actions when different events occur. For example, the product can start a recording or send an email notification when motion is detected. The set of conditions that defines how and when the action is triggered is called an action rule.

### How to direct the camera to a preset position when the camera detects motion

This example explains how to set up the camera to go to a preset position when it detects motion in the image.

Make sure the AXIS Video Motion Detection application is running:

1. Go to **Settings > Apps > AXIS Video Motion Detection**.
2. Start the application if it is not already running.
3. Make sure you have set up the application according to your needs.

Add a preset position:

4. Go to **Settings > PTZ** and set where you want the camera to be directed by creating a preset position.

Create an action rule:

5. Go to **Settings > System > Events > Action rules** and add an action rule.
6. Type a name for the action rule.
7. From the list of triggers, select **Applications** and then select **AXIS Video Motion Detection (VMD)**.
8. From the list of actions, select **PTZ Control** and then select **Preset Position**.
9. Select the preset position you want the camera to go to.
10. Click **Ok**.

### How to automatically zoom in on a specific area with gatekeeper

This example explains how to use the gatekeeper functionality to make the camera zoom in automatically on the license plate of a car that passes through a gate. When the car has passed, the camera zooms out to the home position.

Create the preset positions:

1. Go to **Settings > PTZ > Preset positions**.
2. Create the home position that includes the entrance of the gate.
3. Create the zoomed-in preset position so that it covers the area in the image where you assume that the license plate will appear.

Create a motion detection profile:

4. Go to **Settings > Apps** and open **AXIS Video Motion Detection**.

# AXIS Q6154–E PTZ Dome Network Camera

## Setup

---

5. Create a profile that covers the entrance of the gate and then save the profile.

Create an action rule:

6. Go to **Settings > System > Events** and add an action rule.
7. Name the action rule *Gatekeeper*.
8. From the trigger list, select **Applications** and then select the previously created motion detection profile.
9. From the action list, select the previously created preset position.
10. Click **OK**.

### How to record video when the camera detects impact

Shock detection allows the camera to detect tampering caused by vibration or shock. Vibration caused by the environment or an object can trigger an action depending on the shock sensitivity range, which can be set from 0 to 100. In this scenario, someone is throwing rocks at the camera during after hours and you would like to receive a video clip of the event.

1. Go to **Settings > System > Detectors**.
2. Enable shock detection and set shock sensitivity value.
3. Click **Save**.

Create an action rule:

4. Go to **Settings > System > Events** and add an action rule.
5. Type a name for the action rule.
6. From the list of triggers, select **Detectors** and then select **Shock detection**.
7. From the list of schedules, select **After Hours**.
8. From the list of actions, select **Send Video Clip**.
9. Select an existing stream profile or create a new one.
10. Set the pre-trigger time to 5 seconds.
11. Set the post-trigger time to 60 seconds.
12. Select an existing recipient or create a new one.
13. Click **Ok**.

## Applications

### About applications

AXIS Camera Application Platform (ACAP) is an open platform that enables third parties to develop analytics and other applications for Axis products. To find out more about available applications, downloads, trials and licenses, go to [axis.com/applications](http://axis.com/applications)

To find the user manuals for Axis applications, go to [axis.com](http://axis.com)

#### Note

- Several applications can run at the same time but some applications might not be compatible with each other. Certain combinations of applications might require too much processing power or memory resources when run in parallel. Verify that the applications work together before deployment.

# AXIS Q6154-E PTZ Dome Network Camera

## Troubleshooting

---

### Troubleshooting

If you can't find what you're looking for here, try the troubleshooting section at [axis.com/support](https://axis.com/support)

### How to reset to factory default settings

#### Important

Reset to factory default should be used with caution. A reset to factory default resets all settings, including the IP address, to the factory default values.

To reset the product to the factory default settings:

1. Press and hold the control button and the power button. See *Product overview on page 3*.
2. Release the power button but continue to hold down the control button for 15–30 seconds until the status LED indicator flashes amber.
3. Release the control button.
4. The process is now complete. The product has been reset to the factory default settings. If no DHCP server is available on the network, the default IP address is 192.168.0.90
5. Using the installation and management software tools, assign an IP address, set the password and access the video stream.

It is also possible to reset parameters to factory default through the web interface. Go to **Settings > System > Maintenance** and click **Default**.

### How to check the current firmware

Firmware is the software that determines the functionality of network devices. One of your first actions when troubleshooting a problem should be to check the current firmware version. The latest version may contain a correction that fixes your particular problem.

To check the current firmware:

1. Go to the product's webpage.
2. Click on the help menu. 
3. Click **About**.

### How to upgrade the firmware

#### Important

Preconfigured and customized settings are saved when the firmware is upgraded (provided that the features are available in the new firmware) although this is not guaranteed by Axis Communications AB.

#### Important

Make sure the product remains connected to the power source throughout the upgrade process.

#### Note

When you upgrade the product with the latest firmware, the product receives the latest functionality available. Always read the upgrade instructions and release notes available with each new release before upgrading the firmware. To find the latest firmware and the release notes, go to [axis.com/support/firmware](https://axis.com/support/firmware)

# AXIS Q6154-E PTZ Dome Network Camera

## Troubleshooting

---

1. Download the latest firmware file to your computer, available free of charge at [axis.com/support/firmware](http://axis.com/support/firmware)
2. Log in to the product as an administrator.
3. Go to **Settings > System > Maintenance**. Follow the instructions on the page. When the upgrade has finished, the product restarts automatically.

AXIS Device Manager can be used for multiple upgrades. Find out more at [axis.com/products/axis-device-manager](http://axis.com/products/axis-device-manager)

## Technical issues, clues and solutions

If you can't find what you're looking for here, try the troubleshooting section at [axis.com/support](http://axis.com/support)

### Problems upgrading the firmware

---

Firmware upgrade failure	If the firmware upgrade fails, the product reloads the previous firmware. The most common reason is that the wrong firmware file has been uploaded. Check that the name of the firmware file corresponds to your product and try again.
--------------------------	---

### Problems setting the IP address

---

The product is located on a different subnet	If the IP address intended for the product and the IP address of the computer used to access the product are located on different subnets, you cannot set the IP address. Contact your network administrator to obtain an IP address.
--	---

The IP address is being used by another device	Disconnect the Axis product from the network. Run the ping command (in a Command/DOS window, type <code>ping</code> and the IP address of the product): <ul style="list-style-type: none"><li>• If you receive: <code>Reply from &lt;IP address&gt;: bytes=32; time=10...</code> this means that the IP address may already be in use by another device on the network. Obtain a new IP address from the network administrator and reinstall the product.</li><li>• If you receive: <code>Request timed out</code>, this means that the IP address is available for use with the Axis product. Check all cabling and reinstall the product.</li></ul>
--	---

Possible IP address conflict with another device on the same subnet	The static IP address in the Axis product is used before the DHCP server sets a dynamic address. This means that if the same default static IP address is also used by another device, there may be problems accessing the product.
---	---

### The product cannot be accessed from a browser

---

Cannot log in	When HTTPS is enabled, ensure that the correct protocol (HTTP or HTTPS) is used when attempting to log in. You may need to manually type <code>http</code> or <code>https</code> in the browser's address field.
---------------	--

If the password for the user `root` is lost, the product must be reset to the factory default settings. See *How to reset to factory default settings on page 15*.

The IP address has been changed by DHCP	IP addresses obtained from a DHCP server are dynamic and may change. If the IP address has been changed, use AXIS IP Utility or AXIS Device Manager to locate the product on the network. Identify the product using its model or serial number, or by the DNS name (if the name has been configured).
---	--

If required, a static IP address can be assigned manually. For instructions, go to [axis.com/support](http://axis.com/support)

Certificate error when using IEEE 802.1X	For authentication to work properly, the date and time settings in the Axis product must be synchronized with an NTP server. Go to <b>Settings &gt; System &gt; Date and time</b>
--	---

### The product is accessible locally but not externally

---

Router configuration	Check that your router allows incoming data traffic to the Axis product. The router must support UPnP®.
----------------------	---

Firewall protection	Check the Internet firewall with your network administrator.
---------------------	--



# AXIS Q6154-E PTZ Dome Network Camera

## Troubleshooting

---

### Problems with streaming

---

Multicast H.264 only accessible by local clients	Check if your router supports multicasting, or if the router settings between the client and the product need to be configured. The TTL (Time To Live) value may need to be increased.
No multicast H.264 displayed in the client	Check with your network administrator that the multicast addresses used by the Axis product are valid for your network.  Check with your network administrator to see if there is a firewall preventing viewing.
Poor rendering of H.264 images	Ensure that your graphics card is using the latest driver. The latest drivers can usually be downloaded from the manufacturer's website.
Color saturation is different in H.264 and Motion JPEG	Modify the settings for your graphics adapter. Go to the adapter's documentation for more information.
Lower frame rate than expected	<ul style="list-style-type: none"><li>• See <i>Performance considerations on page 17</i>.</li><li>• Reduce the number of applications running on the client computer.</li><li>• Limit the number of simultaneous viewers.</li><li>• Check with the network administrator that there is enough bandwidth available.</li><li>• Lower the image resolution.</li><li>• Log in to the product's webpage and set a capture mode that prioritizes frame rate. Changing the capture mode to prioritize frame rate might lower the maximum resolution depending on the product used and capture modes available.</li><li>• The maximum frames per second is dependent on the utility frequency (60/50 Hz) of the Axis product.</li></ul>

## Performance considerations

When setting up your system, it is important to consider how various settings and situations affect the performance. Some factors affect the amount of bandwidth (the bitrate) required, others can affect the frame rate, and some affect both. If the load on the CPU reaches its maximum, this also affects the frame rate.

The following factors are the most important to consider:

- High image resolution or lower compression levels result in images containing more data which in turn affects the bandwidth.
- Rotating the lens manually will result in better performance compared to rotating the image from the GUI.
- Access by large numbers of Motion JPEG or unicast H.264 clients affects the bandwidth.
- Simultaneous viewing of different streams (resolution, compression) by different clients affects both frame rate and bandwidth.

Use identical streams wherever possible to maintain a high frame rate. Stream profiles can be used to ensure that streams are identical.

- Accessing Motion JPEG and H.264 video streams simultaneously affects both frame rate and bandwidth.
- Heavy usage of event settings affects the product's CPU load which in turn affects the frame rate.
- Using HTTPS may reduce frame rate, in particular if streaming Motion JPEG.
- Heavy network utilization due to poor infrastructure affects the bandwidth.
- Viewing on poorly performing client computers lowers perceived performance and affects frame rate.
- Running multiple AXIS Camera Application Platform (ACAP) applications simultaneously may affect the frame rate and the general performance.

# AXIS Q6154-E PTZ Dome Network Camera

## Specifications

---

### Specifications

To find the latest version of the product's datasheet, go to the product page at [axis.com](http://axis.com) and locate **Support & Documentation**.

### LED indicators

Status LED	Indication
Unlit	Connection and normal operation.
Green	Shows steady green for 10 seconds for normal operation after startup completed.
Amber	Steady during startup. Flashes during firmware upgrade or reset to factory default.
Amber/Red	Flashes amber/red if network connection is unavailable or lost.

### SD card slot

#### **NOTICE**

- Risk of damage to SD card. Do not use sharp tools, metal objects, or excessive force when inserting or removing the SD card. Use your fingers to insert and remove the card.
- Risk of data loss and corrupted recordings. Do not remove the SD card while the product is running. Unmount the SD card from the product's webpage before removal.

This product supports SD/SDHC/SDXC cards.

For SD card recommendations, see [axis.com](http://axis.com)



SD, SDHC, and SDXC Logos are trademarks of SD-3C LLC. SD, SDHC and SDXC are trademarks or registered trademarks of SD-3C, LLC in the United States, other countries or both.

### Buttons

#### Control button

The control button is used for:

- Resetting the product to factory default settings. See *How to reset to factory default settings on page 15*.
- Connecting to an AXIS Video Hosting System service. To connect, press and hold the button for about 3 seconds until the status LED flashes green.

#### Power button

The power button is used with the control button to reset the camera to factory default settings. See *page 15*.

### Connectors

#### Network connector

RJ45 Push-pull Connector (IP66) with High Power over Ethernet (High PoE).

#### **NOTICE**

Use the supplied midspan.

# AXIS Q6154-E PTZ Dome Network Camera

## Specifications

---

**NOTICE**

To comply with the IP66-rated design of the camera and maintain the IP66 protection, the supplied RJ45 Push-pull Connector (IP66) shall be used. Alternatively, use the RJ45 IP66-rated cable with premounted connector which is available from your Axis reseller. Do not remove the plastic network connector shield from the camera.

