



# 2015 Product Catalog



CHATSWORTH  
PRODUCTS

Optimize.  
Store.  
Secure.

<b>Introduction to Chatsworth Products</b>	<b>Pages i - viii</b>
--	-----------------------

<b>Cabinet, Containment &amp; Enclosure Systems</b>	<b>Section 1</b>
---	------------------

<b>Cable Management Products</b>	<b>Section 2</b>
----------------------------------	------------------

<b>Cable Runway &amp; Tray Products</b>	<b>Section 3</b>
---	------------------

<b>Environmental Monitoring &amp; Security Systems</b>	<b>Section 4</b>
--	------------------

<b>Grounding &amp; Bonding Products</b>	<b>Section 5</b>
---	------------------

<b>KVM Systems</b>	<b>Section 6</b>
--------------------	------------------

<b>Power Management Products</b>	<b>Section 7</b>
----------------------------------	------------------

<b>Rack Systems</b>	<b>Section 8</b>
---------------------	------------------

<b>Seismic Protection Systems</b>	<b>Section 9</b>
-----------------------------------	------------------

<b>Wall-Mount Systems</b>	<b>Section 10</b>
---------------------------	-------------------

<b>Zone Cabling &amp; Wireless Enclosures</b>	<b>Section 11</b>
---	-------------------

<b>Index</b>	<b>Section 12</b>
--------------	-------------------

# WELCOME FROM CPI

To know Chatsworth Products (CPI) is to know our motto – “Delight the Customer.” As an employee-owned company, it is important for us to work with you on an individual basis to deliver quality products and services for every IT infrastructure need. Whether you are placing an order through customer service or clarifying a project through technical support, CPI’s team of experienced professionals will find the perfect solution. It is that dedication to solving the needs of customers that led to providing our most popular products for IT infrastructure solutions in this catalog. If there is something you cannot find, give us a call at 800-834-4969, and we will be happy to delight you too!

## WHAT WE DO

CPI is a global manufacturer of voice, data and security products that Optimize, Store and Secure information and communications technology (ICT) equipment. Offering quality in-stock products and customized solutions, CPI leads the industry in innovation, configurability and value with an array of integrated system components that cover virtually all equipment storage and cable management needs. Our organization’s knowledge and expertise allow us to communicate and collaborate with IT professionals, architects, contractors, engineers, OEM equipment manufacturers, integrators and end users, working in a partnership each step of the way to create custom-fit IT infrastructure solutions. Headquartered in the United States, CPI operates global offices within the U.S., Mexico, Canada, China, United Arab Emirates and United Kingdom.



## WHY CHOOSE CPI?

### HISTORY

Twenty years ago, CPI began when 90 employees joined together and purchased the Dracon Division of Harris Corporation, using an Employee Stock Ownership Plan (ESOP). With deregulation in the telecommunications industry and technological innovation in voice and data equipment, CPI focused on the explosive needs of the information technology market to manage IT infrastructure equipment. Today, CPI is a leading global supplier of integrated solutions that optimize information and communications technology (ICT) equipment. This pioneering spirit is what motivates CPI to delight the customer by responding rapidly with tailored standard and custom solutions that give them a higher return on their investment.

### WHO WE SERVE

As technology needs evolve, so does CPI. Whether it is organizing cable in a network cabinet, securing data in a brand new facility, ensuring security for banking institutions or satisfying HIPAA requirements in a colocation facility, CPI has the experience and know-how to provide the perfect solution at the perfect time.

Some of the markets we have served include:

- Banking & Financial Services
- Telecommunications
- Government (Federal, State and Local)
- Pharmaceutical & Biotech
- Consulting & Business Services
- Healthcare & Medical
- Insurance
- Media & Entertainment
- Retail
- Information Technology
- Electronics
- Education
- Security

**CPI is committed to being a company of the highest quality in every aspect of its business, providing Quality Products, Quality Services and most of all – Quality People.**

## CUSTOMIZED SOLUTIONS

A great deal of precision and thought goes into the design of today's data center, but plans can change in an instant. Each step comes with its own set of obstacles, from a need to maintain energy costs through thermal management solutions, to the deployment of quality-built cabinets that can withstand high-density loads and earthquakes. As the environment within data centers continually changes, infrastructure systems must be able to change too. That is why CPI provides the marketplace with a variety of high-quality, unique solutions that allow for future technology and evolving standards.

## VALUE-ADDED ONLINE TOOLS

The design and implementation of everything, from network closets, to sprawling data centers is literally filled with twists and turns. That is why CPI has developed a robust support structure at [www.chatsworth.com](http://www.chatsworth.com) that can help you plan designs and solutions for any IT infrastructure need. Some of the most popular online resources include Building Information Modeling (BIM) drawings which are now available on Autodesk Seek, the e-Catalog, a full documentation library and our Product Configurator that has been utilized to create more than 100,000 personalized solutions.

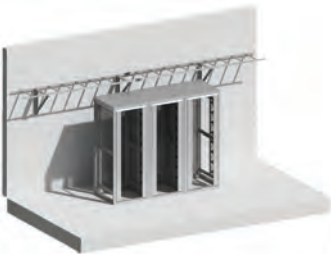

## LEADING THE WAY IN RESEARCH, DEVELOPMENT & TRAINING

With the financial strength to reinvest in the company and continually improve manufacturing and logistical processes, CPI has become an industry leader in product innovation and excellence. Complementing our numerous active patents for ground breaking product designs, CPI has its own Research Development and Training (RD&T) Center. Designed with customers in mind, the RD&T Center is a comprehensive facility complete with a Product Showroom, Customer Meeting Center and a Thermal Test Lab.

In addition to giving customers a chance to learn and interact directly with CPI Products and Solutions, the test lab is equipped to model various heat loads, cabinet configurations and conduct in-house product testing. For more information or to schedule a visit, go to [www.chatsworth.com/rdt](http://www.chatsworth.com/rdt).

## INDUSTRY AFFILIATIONS

CPI maintains its comprehensive product and industry knowledge with help from the following affiliations and associations:

- Industry Advisory Council (IAC)
- Underwriters Laboratories, Inc. (UL)
- The Green Grid
- US Green Builders Council (USGBC)
- AFCOM National and Local Chapters
- ASHRAE
- TIA
- BICSI Platinum Level Prestige Corporate Member (PCM)
- BICSI Standards Committee
  - Data Center Rack and Cabinet Editor
  - Mechanical Group
  - Thermal Consultant
  - BIM Best Practices Subcommittee
- Society of Telecommunications Consultants (STC)
- International Organization for Standardization (ISO)
- Armed Forces Communications and Electronics Association (AFCEA)
- ESOP Association

## EXPERT SERVICE AND SUPPORT

CPI understands that the high-speed world of data management is constantly changing and for this reason, we offer highly trained Technical Support Specialists and Customer Service Representatives to help solve your IT infrastructure needs. Based on your specific requirements, our Technical Support Specialists can help design the precise layout for your data center, and provide a detailed bill of material complete with layout and assembly drawings. Furthermore, our Customer Service Representatives work closely with distributors to maintain product availability, ultimately helping preserve your project's scheduling requirements.

# CPI CONTACT INFORMATION

## CPI Global Offices:

### Corporate Office - Westlake Village, CA

818-735-6100 • 818-735-6199 FAX



### Chatsworth, CA Operations

818-882-8595 • 818-718-0473 FAX



### New Bern, NC Operations

252-514-2779 • 252-514-2977 FAX



### Georgetown, TX Operations

512-863-7800 • 512-869-1374 FAX



### Asia Pacific

Pudong, Shanghai, China

+86-21-6880-0266

[www.chatsworth.com.cn](http://www.chatsworth.com.cn)



### Latin America

Mexico City, Mexico

+52-55-5203-7525, toll free: 01-800-201-7592

[www.chatsworth.com.co](http://www.chatsworth.com.co)

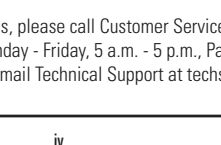

### Europe

Buckinghamshire, England, UK

+44-01628-524-834

[www.chatsworthproducts.co.uk](http://www.chatsworthproducts.co.uk)

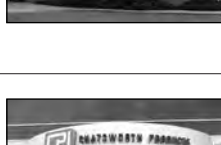

### Middle East & Africa

Dubai, United Arab Emirates

+971-4-2602125

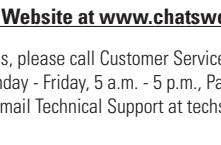

### Canada

Toronto, Ontario, Canada

+905-850-7770

**Visit our Global Website at [www.chatsworth.com](http://www.chatsworth.com)**

For answers to your questions or for custom solutions, please call Customer Service or Technical Support at **1-800-834-4969** (toll free in the U.S. & Canada) Monday - Friday, 5 a.m. - 5 p.m., Pacific Time; **1-818-739-3400** (outside of the U.S. & Canada), or email Technical Support at [techsupport@chatsworth.com](mailto:techsupport@chatsworth.com).

**HOW TO ORDER**

CPI sales are conducted in partnership with a global network of distributors, contractors and resellers. To obtain a purchase price quote and product availability, please locate the CPI partner nearest you by calling 800-834-4969.

This catalog has been developed according to comprehensive product groups. Each group is presented as a convenient section within the catalog and contains part numbers, ordering information and detailed illustrations or photographs.

**TO ORDER, FOLLOW THESE SIMPLE STEPS:**

1. Locate desired product(s) within the appropriate section.
2. Use the complete part number. Pay close attention to the digits indicating product variations such as size, finish (refer to Color Finishes information) and hole pattern.
3. Check "Consists Of" information for each product for a listing of all components and hardware included with the part number.
4. Check to see if product descriptions include "Installation May Require" or "Installation Will Require" the following hardware. These components are not included with the product; however, most of these items are contained in the catalog and may be ordered. Please see part number references where indicated.
5. Indicate quantity and full part numbers in your purchase orders (POs). The description is not essential but should be included when ordering. The product description will appear on your acknowledgment, invoice and packing list.
6. Locate a distributor by calling 800-834-4969 or visiting [www.chatsworth.com](http://www.chatsworth.com). If you are an authorized CPI distributor, send POs via mail or fax to one of our Customer Service Department locations listed to the right.
7. Questions? Call CPI toll-free at 800-834-4969 within the United States and Canada, or visit [www.chatsworth.com](http://www.chatsworth.com).

*Note: Prices and quantity breakdowns are not listed in this product guide. For product pricing, please contact our Customer Service Department at 800-834-4969.*

*All orders received are subject to acceptance by CPI and are subject to a minimum charge of \$200.00. CPI must receive written confirmation for all orders prior to shipment.*

*Products listed do not include export packaging, insurance, taxes, tariffs or duties.*

*All pricing is subject to change. CPI reserves the right to make adjustments to pricing and product offerings for reasons including, but not limited to, changing market conditions, product discontinuations, product unavailability and price changes.*

**FEDERAL, STATE AND LOCAL GOVERNMENT BUSINESS**  
**GSA CONTRACT NO. GS-35F-0184N**

CPI is listed with the General Services Administration (GSA) under Federal Supply Schedule 70 for General Purpose Commercial Information Technology Equipment, Software and Services, is a Small Business manufacturer (SB) and is available through GSA Advantage, NETCENTS, SEWP III, NITAAC-ECSIII, GSA Connections, as well as other channels. For more information, visit [www.chatsworth.com/gov](http://www.chatsworth.com/gov).

**COLOR FINISHES**

CPI utilizes the powder-coating finishing process to produce a durable, long-lasting finish that is aesthetically superior to other techniques. The majority of CPI Products are available in three colors (white, black and gray) and a grained metal finish, referred to as "clear." CPI's powder-coating and curing techniques provide a more consistent, uniform finish. Therefore, the color is evenly applied (even on angles, die cuts or unique shapes) and does not vary among different products. CPI's "White" or "Computer White" will now be distinguished as "Computer Beige." These are the same colors and indicate an off-white color designed to coordinate with typical computer-white products. CPI's bright white cabinet color is designated as "Glacier White."

**CUSTOMER SERVICE DEPARTMENTS****Chatsworth, CA Operations**

Chatsworth, CA 91311-5205  
 Ph: 818-882-8595 • Fax: 818-718-0473

**Georgetown, TX Operations**

Georgetown, TX 78626  
 Ph: 512-863-7800 • Fax: 512-869-1374

**New Bern, NC Operations**

New Bern, NC 28562-5447  
 Ph: 252-514-2779 • Fax: 252-514-2977

**Europe Office**

Buckinghamshire, England, UK SL8 5AS  
 Ph: +44-1628-524-834

**Canada Office**

Toronto, Ontario, Canada  
 Ph: +905-850-7770

**Asia Pacific Office**

Pudong, Shanghai, China  
 Ph: +86 21 6880-0266

**1-800-834-4969** (toll free in the U.S. & Canada)

**1-818-739-3400** (outside of the U.S. & Canada)

**TERMS & CONDITIONS**

CPI maintains a policy of continuous product improvement; therefore, we reserve the right to make changes without notice.

**WARRANTY**

CPI guarantees manufactured products and each part or component thereof against all defects in material and/or workmanship. CPI agrees to remedy any manufacturing defect, either through replacement or repair, at no charge, provided that the defective unit is returned, transportation prepaid, to the CPI factory. The warranty extends for a period of one year from the date of installation or initial use, provided that this period shall not exceed 18 months from the original date of shipment from factory.

Any product that has been repaired or replaced shall be similarly warranted on its repair or replacement for the remaining product warranty period or 90 days from the date of repair or replacement, whichever expires last.

This warranty does not extend to products that have been subjected to neglect, accident or improper use, nor to units that have been altered by non-CPI personnel.

No warranties other than those set forth in this section are given or implied with respect to the products furnished. CPI shall, in no event, be liable for consequential damages, for loss, damage or expense directly or indirectly arising from the use of the products, for any inability to use materials or from any other cause.

**NON-WARRANTY REPLACEMENTS**

CPI Products are not serviceable in the field, and customers are encouraged to return them to CPI Customer Service for repairs.

Some documentation and replacement components are available for purchase from CPI. Please contact CPI Customer Service for ordering information and availability.

**RETURNS AND REPAIRS**

No products or part thereof shall be returned to CPI unless the customer first obtains a Customer Return Authorization Number from a CPI Customer Service Representative. This number must appear clearly and prominently on all shipping containers. Containers without the labels will not be accepted.

Products returned for warranty repair shall be shipped prepaid to CPI. Some products are subject to handling charges if no defects are found during inspection. All products returned to CPI shall be packaged to prevent damage during shipment. Any damage that occurs during shipment is the responsibility of the customer and the shipping company. CPI will send back repaired products freight prepaid.

If CPI finds that products returned for repair, whether in or out of warranty, have failed due to misuse or negligence or have components removed, CPI will repair the product in accordance with "out-of-warranty" charges. If CPI finds products, in or out of warranty, to be damaged beyond repair, the customer can choose to have the product sent back "as is" or scrapped by CPI.

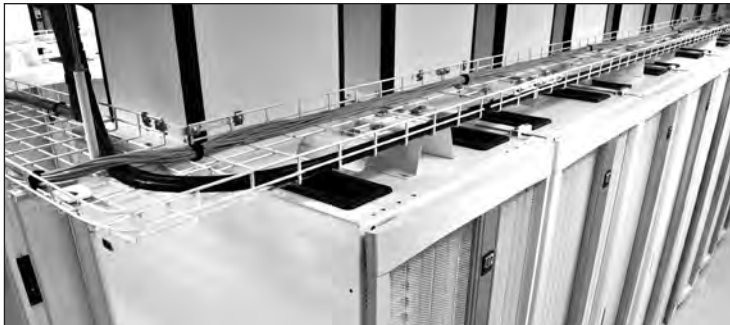



**ISO 9001-2008 REGISTRATION**

<u>Operation</u>	<u>Certificate Registration No.</u>
Chatsworth, CA	10002325 QM08 Ref. 10002325
New Bern, NC	10002325 QM08 Ref. 10004453
Georgetown, TX	10002325 QM08 Ref. 10004454

The UL Registered Firm symbol indicates that the facility has passed UL's evaluation to the international quality standards of the International Organization for Standardization. This means the facility has been thoroughly monitored and has participated in an audit to determine compliance with a strict and comprehensive set of quality specifications. An appropriate quality system must be demonstrated to meet these specifications for quality in the relevant areas of design, development, production, assembly, final inspection and testing.



The UL Classified symbol indicates that Underwriters Laboratories Inc. classifies the product as an equipment grounding conductor only.



The UL Listed symbol indicates the product is listed to applicable UL Standards and requirements by Underwriters Laboratories Inc.



The cULus symbol indicates compliance with both Canadian and U.S. requirements by Underwriters Laboratories Inc.



The UL Component Recognition symbol is used on components that are part of a larger product or system.



The CE Marking is a European marking of conformity, indicating a product complies with the requirements of the applicable European laws with respect to safety, health environment and consumer protection.



**ENVIRONMENTALLY SAFE**

CPI is committed to recycling as the solution to environmental and landfill concerns and continues to pursue packaging solutions that are cost effective and environmentally friendly.

**NON-CPI REGISTRATION MARKS**

- Aironet® is a registered trademark of Cisco Systems, Inc.
- AisleLok® and AisleLok® Acrycell™ are registered trademarks of Upsite Technologies, Inc.
- AT&T® is a registered trademark of AT & T Intellectual Property, Inc.
- AutoCAD® is a registered trademark of Autodesk, Inc.
- Cisco® is a registered trademark of Cisco Systems, Inc.
- Compaq® is a registered trademark of Hewlett Packard Development Company, L.P.
- Dell™ is a trademark of Dell Inc.
- Delrin® is a trademark of E.I duPont de Nemours & Company (DuPont).
- HP® is a registered trademark of Hewlett-Packard Development Company, L.P.
- Hilti® is a Registered trademark of Hilti Corporation
- HotLok® is a registered trademarks of Upsite Technologies
- Hubbell® is a registered trademark of Hubbell Inc.
- IBM® is a registered trademark of IBM Corporation
- Krone® is a registered trademark of ADC GmbH
- KoldLok® is a registered trademarks of Upsite Technologies
- Lexan® is a registered trademark of SABIC Innovative Plastics
- Slip-on® is a registered trademark of Slip-on Lock Nut Company Corporation
- Velcro® is a registered trademark of Velcro Industries B.V.
- Visio® is a registered trademark of Microsoft Corporation.

All other trademarks belong to their respective companies.



## CUSTOMER SERVICE & TECHNICAL SUPPORT

Customer Service is available in the U.S. at 800-834-4969 (Monday - Friday, 5 a.m. - 5 p.m., Pacific Time). For Customer Service locations outside of the U.S., refer to page four for office information. Our friendly and professional Customer Service Representatives have the experience and know-how to ensure you get the right solutions for your needs. Customer Service Representatives are available to answer questions about CPI Products, direct you to a distributor, help you find what you need on CPI's website or to provide product information sheets via fax or e-mail.

Technical Support is also available at 800-834-4969 (Monday - Friday, 5 a.m. - 5 p.m., Pacific Time) or via e-mail at [techsupport@chatsworth.com](mailto:techsupport@chatsworth.com). CPI's team of knowledgeable support personnel takes pride in getting the right answers to you quickly to help you meet your project requirements.



## DESIGN TOOLS

CPI provides a number of free services that can be downloaded from a number of sources. Our new CPI Mini Catalog APP can be downloaded from the Apple Store to your iPad and allows you to create a bill of material (BOM) list, build a part number, search catalog pages by keywords or part number, link to product documentation and bookmark pages. It even allows you to push your BOM list to CPI's Mobile App Suite! Download the CPI Mobile App Suite from the Apple Store or Google Play to your mobile device or tablet, and utilize our Cable Fill Calculator, Cabinet Selector, eConnect PDU Selector and Wall-Mount Product Selector.

Free Visio® Shapes help you plan your next project and free CAD Blocks (dwg files) help you quickly and accurately develop a room layout. BIM models are also available. For more information about these tools, visit [www.chatsworth.com/designtools](http://www.chatsworth.com/designtools).

## ONLINE TOOLS

To accommodate our customers in every possible way, CPI provides a variety of value-added online tools.



## PRODUCT CONFIGURATOR

The Product Configurator will guide you through the steps and selections necessary to create personalized Racks, Cabinets and Enclosure Systems, and Wall-Mount Systems. Once built, the Product Configurator will present a total list price, rendered drawings and offer a selection of distributors or global resellers. Access this tool at [www.chatsworth.com/configurator](http://www.chatsworth.com/configurator).

## eCATALOG

Our eCatalog is a tool that will allow users to view products and their descriptions, create project carts, receive MSRP pricing and locate a distributor for a quote. The eCatalog can be accessed at [www.chatsworth.com](http://www.chatsworth.com).

## CPI PUE CALCULATOR

The CPI PUE Calculator will determine your data center cost savings by combining CPI Passive Cooling® Solutions with today's most effective cooling strategies. By utilizing your existing energy consumption and cost data information, the CPI PUE Calculator will identify the efficiency of CPI Passive Cooling Solutions in your exact data center environment. Check out this tool at [www.chatsworth.com/pue-calculator](http://www.chatsworth.com/pue-calculator).

## DOCUMENTATION CENTER

CPI's Documentation Center is a comprehensive online reference that will provide you with the ability to search specific product and general company information. It is an easy and quick way to retrieve printable documentation to support bids and proposals. Access by selecting "Supports and Downloads" then "Documentation Center" from the [www.chatsworth.com](http://www.chatsworth.com) homepage.

## CPI NEWSLETTER AND BLOG

Let CPI send you updates. Sign up for the CPI newsletter, "The Source" at [www.chatsworth.com/About-CPI-The-Source-Newsletter](http://www.chatsworth.com/About-CPI-The-Source-Newsletter) or our Blog at [www.chatsworth.com/blog](http://www.chatsworth.com/blog).

# CABINET, CONTAINMENT & ENCLOSURE SYSTEMS

Cabinets, Aisle Containment, Thermal & Cable Management Accessories



## Cabinet Comparison Chart

F-Series TeraFrame® Gen 3 Cabinet

F-Series TeraFrame® HD Cabinet

N-Series TeraFrame® Gen 3 Cabinet

GF-Series GlobalFrame® Gen 2 Cabinet

Z4-Series SeismicFrame® Cabinet

M-Series MegaFrame® Cabinets

C-Series SlimFrame® Cabinets

Page 1-3

Page 1-4

Page 1-15

Page 1-19

Page 1-26

Page 1-37

Page 1-43

Page 1-52

E-Series ISP Co Location Cabinets

Cabinet Accessories & Shelves

Aisle Containment Overview

Aisle Containment Door Assembly

Build To Spec (BTS) Hot Aisle (HAC)

Cabinet Supported Hot Aisle (HAC)

Frame Supported Hot Aisle (HAC)

Cabinet Supported Cold Aisle (CAC)

Page 1-56

Page 1-57

Page 1-64

Page 1-65

Page 1-68

Page 1-72

Page 1-76

Page 1-80

# CABINET, CONTAINMENT & ENCLOSURE SYSTEMS

The cabinet platform on which your enterprise is built is just as critical as the equipment it stores. Utilizing a properly configured cabinet that is designed to fit your equipment and work with your data center's cooling system is crucial. Leading the industry with innovative storage solutions, CPI Cabinet and Enclosure Systems provide a trusted frame and secure location for storing multiple servers, switches and various pieces of computer equipment. CPI Cabinet and Enclosure Systems are also designed to promote energy savings and enhanced thermal management solutions that utilize CPI Passive Cooling® through the use of Aisle Containment and Vertical Exhaust Ducts.

Infinite configurability helps meet your growing enterprise needs through additional features, such as remote environmental monitoring, power distribution, seismic accessories, grounding and bonding, locking systems and advanced cable management.

## **CPI Cabinet, Containment and Enclosure Systems feature:**

- Four vertical mounting rails for four-point attachment
- Standard EIA-310-D and EIA/ECA-310-E hole pattern
- Industry-leading performance standards, like high static load ratings and shock pallet options
- High static load rating, ranging from 800 lb (362.9 kg) to 3000 lb (1360 kg)
- High dynamic load rating of 3000 lb (1360 kg) on some models
- Large open base for cable entry and exit
- Rack-mount unit markings on most rails and channels for fast equipment mounting
- Options and accessories that can be pre-installed, reducing data center installation time
- Green energy-saving thermal management options and configurations
- Extensive cable management options and features that keep cables organized and make installation changes easy
- High static load ratings; 750 lb (340.2 kg) to 2200 lb (1000.0 kg)

## **Featured Product:**



*N-Series TeraFrame Gen 3 Network Cabinet*  
Page 1-19



*Z4-Series SeismicFrame Cabinet*  
Page 1-37

## Cabinet Systems

CPI continuously provides flexibility in meeting the challenges of changing data and telecommunications technology. To meet these changes, CPI develops cabinets that are well-designed, forward-thinking and versatile.

The chart below lists the main style differences between CPI's cabinet families. Cabinets are available in several styles and sizes with a choice of included equipment mounting rails, side panels and doors.

### When selecting a CPI Cabinet consider:

- Overall and usable width and depth
- Rack-mount units (U) required
- Aluminum or steel construction
- Style of equipment mounting rail (five to choose from)
- Door style (five styles including double doors)
- Cabinets are available without doors, sides or tops
- Color
- Fully or partially assembled

**CPI Cabinet Comparison Chart**

Product	Key Attribute	Overall/Width (Rack-Mount) in (mm)	Material & Construction	Load Rating lb (kg)	Available Partially Assembled
F-Series TeraFrame® Gen 3 Cabinet System Page 1-4	Select from 561 standard frame sizes to exactly match site requirements.	23.6 (600)/19" EIA 27.6 (700)/19" EIA 31.5 (800)/19" EIA	Steel and Aluminum, Welded and Bolted	3000 (1360) 2500 (1134)	No
F-Series TeraFrame® HD Cabinet System Page 1-15	Quick deployment, re-ship cabinet with equipment pre-installed.	23.6 (600)/19" EIA	Steel and Aluminum, Welded and Bolted	3000 (1360)	No
N-Series TeraFrame® Network Cabinet Page 1-19	Control side exhaust airflow from network and storage switches.	31.5 (800)/19" EIA 40.0 (1016)/19" EIA	Steel and Aluminum, Welded and Bolted	2500 (1134)	No
GF-Series GlobalFrame® Gen 2 Cabinet System Page 1-26	Available in 60 industry standard sizes.	23.6 (600)/19" EIA 27.6 (700)/19" EIA 29.5 (750)/19" EIA 31.5 (800)/19" EIA	Steel and Aluminum, Welded and Bolted	3000 (1360) 2500 (1134)	No
Z4-Series SeismicFrame® Cabinet System Page 1-37	Engineered to meet Zone 4 testing requirements in active seismic areas.	23.6 (600)/19" EIA 31.5 (800)/19" EIA	Steel, Welded and Bolted	1500 (680)	No
M-Series MegaFrame® Cabinet System Page 1-43	Lightweight frame allows easy movement onto the site.	27.3 (693)/19" EIA 27.6 (700)/23" EIA 31.3 (795)/19" EIA	Aluminum, Bolted	2000 (907.2)	Yes
C-Series SlimFrame® Cabinet System Page 1-52	Lightweight frame allows easy movement onto the site.	24.0 (610)/19" EIA	Aluminum, Bolted	2000 (907.2)	Yes
E-Series ISP Co Location Cabinet Page 1-56	Lightweight frame with three secure compartments in one cabinet.	27.3 (693)/19" EIA 31.3 (795)/23"	Aluminum, Bolted	2000 (907.2)	Yes

# F-SERIES TERAFRAME® GEN 3 CABINET SYSTEM



## F-Series TeraFrame® Gen 3 Cabinet System

The F-Series TeraFrame® Gen 3 Cabinet System optimizes, stores and secures computer, data storage and network equipment in the data center, computer room or network environment. Every cabinet is available in a wide range of standard sizes and configurations to match your equipment and facility requirements.

The third generation F-Series TeraFrame features an enhanced frame design, new sizes and panels, easier equipment rail adjustment and smarter airflow management. A new 6-slide frame style increases the cabinet's equipment load bearing capacity and is also available in a standard 52U height to maximize space. Side panels are half height, so they are easier to handle, and the cable openings in the top and bottom panels are wider to accommodate large PDU power plugs. Equipment mounting rails are now Z-shaped with a solid front surface, use no standoff brackets, adjust quickly using less hardware and help block bypass airflow around equipment. There are grommet-sealed cable openings in the rails in wider cabinets that allow a dedicated front-to-rear pathway for cabling, while blocking unwanted bypass airflow. Every cabinet also includes casters to ease placement, and leveling feet can be adjusted quickly using a ball hex driver.

Airflow management is an integral part of every cabinet, so brush seals cover all of the cable openings in the top and bottom panels. A new two-piece server top panel design provides an upgrade path to Vertical Exhaust Duct as thermal loads increase. When ordered with a duct, a bottom panel, airflow director and rear door seal are included with the cabinet to channel hot exhaust air to the duct. For best performance, use with the improved Air Dam and Snap-In Filler Panels to form a complete seal around the sides, top of the cabinet and in between rack-mount equipment.

Combine the F-Series TeraFrame with thermal and cable management accessories to create a solution that fits your exact needs.

### Cabinet Specifications:

- Available in 11 heights, three widths and 17 depths
- Provides front and rear support for 19"W (482.6 mm) EIA rack-mount equipment and shelves
- Adjustable depth, rails slide front-to-back
- Marks on frame for easy vertical alignment
- 1-3/4"H (44.45 mm) U spacing, marked and numbered
- 19"W, EIA-310-E Universal vertical hole spacing
- Load capacity for 6-slide frame (per UL2416):
  - 3000 lb (1360 kg), static load on leveling feet
  - 2250 lb (1020 kg), rolling load on casters
- Load capacity for 4-slide frame (per UL2416):
  - 2500 lb (1134 kg), static load on leveling feet
  - 2000 lb (907.2 kg), rolling load on casters

### Cabinet Includes:

- Welded steel and bolted aluminum four-post frame
- Equipment mounting rails, two pairs
- Equipment rail grommet kit
- Grounding/bonding system and ground lug
- Leveling feet and casters
- Floor attachment brackets
- Baying kit, for 600 mm or 24" spacing
- PDU brackets, one pair, for two 2.2"W (56 mm) vertical CPI PDUs
- Equipment mounting hardware, (50) M6 cage nuts and screws

### Certifications:

- EIA-310-E compliant
- UL Listed 2416, NWWIN, File #E227626

# F-SERIES TERAFRAME® GEN 3 CABINET SYSTEM

Use the part number configurator below to select a standard F-Series TeraFrame. Choose the **Height**, **Width**, **Depth**, **Rail Style**, **Front Door**, **Rear Door**, **Latch**, **Color**, **Top Panel Style**, **Side Panel Style** and **Frame Style**. **Example Cabinet Part Number: FC1U-113B-C42-B**

## Industry Standard Model Matrix:

All selections from this table offer the most affordable pricing and shortest lead times.

<b>F</b>	<b>H</b>	<b>W</b>	<b>D</b>	<b>-</b>	<b>R</b>	<b>F</b>	<b>R</b>	<b>L</b>	<b>-</b>	<b>C</b>	<b>T</b>	<b>S</b>	<b>-</b>	<b>F</b>
----------	----------	----------	----------	----------	----------	----------	----------	----------	----------	----------	----------	----------	----------	----------

1. Height			
U	in	mm	C
42	79.4	2016	<b>C</b>
45	84.6	2149	<b>F</b>
48	89.9	2282	<b>J</b>
52	96.9	2460	<b>N</b>

Height includes casters.

2. Width		
in	mm	
23.6	600	<b>1</b>
27.6	700	<b>2</b>
31.5	800	<b>3</b>

3. Depth		
in	mm	
31.5	800	<b>A</b>
39.4	1000	<b>J</b>
43.3	1100	<b>N</b>
47.2	1200	<b>U</b>

Depth does not include doors.  
Front door adds 2.4" (61 mm)  
Rear door adds 1.5" (38 mm).

4. Rail Style	
Square-Punched, 2-Pair	<b>1</b>

5. Front Door	
None	<b>0</b>
Single, Perforated	<b>1</b>

6. Rear Door	
None	<b>0</b>
Single, Solid Metal	<b>1</b>
Double, Perforated Metal	<b>3</b>

Double Rear Door will include a two-point

11. Frame Style	
<b>B</b>	6-Slide

10. Side Panel Style	
<b>0</b>	None
<b>1</b>	Solid, 1 each
<b>2</b>	Solid, 2 each

9. Top Panel Style	
<b>0</b>	None
<b>2</b>	Network, One-Piece, 4 Cable Openings
<b>4</b>	Server, Two-Piece, 4 Cable Openings
<b>5</b>	Vertical Exhaust Duct, 20"-34"H (508-863 mm)
<b>6</b>	Vertical Exhaust Duct, 34"-60"H (863-1523 mm)

Options 4, 5, & 6 are for cabinets that are 41.3"D (1050 mm) or deeper. Use solid rear door with Vertical Exhaust Duct. Vertical Exhaust Duct includes Bottom Panel and Air Director.

8. Color	
<b>C</b>	Black
<b>E</b>	Glacier White

7. Latch/Locks Kits	
<b>B</b>	Single-Point, Keyed Lock
<b>C</b>	Two-Point, Keyed Lock
<b>D</b>	Single-Point, Keyed/Combination Lock
<b>E</b>	Two-Point, Keyed/Combination Lock
<b>N</b>	None

## Notes:

- Use the perforated doors with Aisle Containment Solutions or traditional hot aisle/cold aisle applications. Use the solid rear door with Vertical Exhaust Duct top panels.
- Select a single-point or two-point latch and a keyed or combination lock. Double doors require a two-point latch. If you select a single-point latch and a double rear door, the front door will have a single-point latch, and the rear door will have a two-point latch.
- There are three styles of top panel. Network top panels are a one-piece panel with four brush-sealed cable openings, one per corner. Server top panels are for cabinets that are 1050 mm D or deeper that may be upgraded with Vertical Exhaust Duct at a future date. Server top panels are two-piece panels with four brush-sealed cable openings, one per corner. The rear piece of the panel is removed to add a Vertical Exhaust Duct. Vertical Exhaust Duct top panels have two brush-sealed cable openings in the front corners, and the duct at the rear of the cabinet. Choose the duct height range that fits the distance between the top of the cabinet and the drop ceiling. Cabinets with Vertical Exhaust Duct top panels include a bottom panel and airflow director and must be used with a solid rear door.

# F-SERIES TERAFRAME® GEN 3 CABINET SYSTEM

Use the part number configurator below to personalize your F-Series TeraFrame. Choose the **Height**, **Width**, **Depth**, **Rail Style**, **Front Door**, **Rear Door**, **Latch**, **Color**, **Top Panel Style**, **Side Panel Style** and **Frame Style**. **Example Cabinet Part Number: FC1U-113B-C42-B**

## Complete Product Matrix:

The complete product matrix includes all options available. The Industry Standard Models that offer affordable pricing and shorter lead times are highlighted.

**F H W D - R F R L - C T S - F**

1. Height			
U	in	mm	C
42	79.4	2016	<b>C</b>
43	81.1	2060	<b>D</b>
44	82.9	2105	<b>E</b>
45	84.6	2149	<b>F</b>
46	86.4	2193	<b>G</b>
47	88.1	2238	<b>H</b>
48	89.9	2282	<b>J</b>
49	91.6	2327	<b>K</b>
50	93.4	2371	<b>L</b>
51	95.1	2416	<b>M</b>
52	96.9	2460	<b>N</b>

Height includes casters.

2. Width		
in	mm	C
23.6	600	<b>1</b>
27.6	700	<b>2</b>
31.5	800	<b>3</b>

3. Depth		
in	mm	C
31.5	800	<b>A</b>
32.5	825	<b>B</b>
33.5	850	<b>C</b>
34.4	875	<b>D</b>
35.4	900	<b>E</b>
36.4	925	<b>F</b>
37.4	950	<b>G</b>
38.4	975	<b>H</b>
39.4	1000	<b>J</b>
40.4	1025	<b>K</b>
41.3	1050	<b>L</b>
42.3	1075	<b>M</b>
43.3	1100	<b>N</b>
44.3	1125	<b>P</b>
45.3	1150	<b>R</b>
46.3	1175	<b>T</b>
47.2	1200	<b>U</b>

Depth does not include doors. Front door adds 2.4" (61 mm) Rear door adds 1.5" (38 mm).

11. Frame Style	
<b>A</b>	4-Slide
<b>B</b>	6-Slide

10. Side Panel Style	
<b>0</b>	None
<b>1</b>	Solid, 1 each
<b>2</b>	Solid, 2 each

9. Top Panel Style	
<b>0</b>	None
<b>2</b>	Network, One-Piece, 4 Cable Openings
<b>4</b>	Server, Two-Piece, 4 Cable Openings
<b>5</b>	Vertical Exhaust Duct, 20"-34" H (508-863 mm)
<b>6</b>	Vertical Exhaust Duct, 34"-60" H (863-1523 mm)

Options 4, 5, & 6 are for cabinets that are 41.3" D (1050 mm) or deeper. Use solid rear door with Vertical Exhaust Duct. Vertical Exhaust Duct includes Bottom Panel and Air Director.

8. Color	
<b>C</b>	Black
<b>E</b>	Glacier White

7. Latch/Locks Kits	
<b>B</b>	Single-Point, Keyed Lock
<b>C</b>	Two-Point, Keyed Lock
<b>D</b>	Single-Point, Keyed/Combination Lock
<b>E</b>	Two-Point, Keyed/Combination Lock
<b>N</b>	None

6. Rear Door	
<b>0</b>	None
<b>1</b>	Single, Solid Metal
<b>3</b>	Double, Perforated Metal

Double Rear Door will include a two-point

5. Front Door	
<b>0</b>	None
<b>1</b>	Single, Perforated

4. Rail Style	
<b>1</b>	Square-Punched, 2-Pair

 = Industry Standard



For the full line of cabinet configurations, use the complete Product matrix or log on to the CPI Configurator on our website at [www.chatsworth.com](http://www.chatsworth.com). For additional assistance, contact Technical Support at 800-843-4969.

## Specifications/Ordering Notes:

1. Heights, Widths, Depths: See tables below for detailed dimensions.

Height Dimensions - in (mm)			
Rack Mount Spaces (U)	Overall with Casters	Frame Only No Casters	Front Opening
42	79.4 (2016)	77.4 (1965)	73.9 (1876)
43	81.1 (2060)	79.1 (2010)	75.6 (1921)
44	82.9 (2105)	80.9 (2054)	77.4 (1965)
45	84.6 (2149)	82.6 (2099)	79.1 (2010)
46	86.4 (2193)	84.4 (2143)	80.9 (2054)
47	88.1 (2238)	86.1 (2187)	82.6 (2099)
48	89.9 (2282)	87.9 (2232)	84.4 (2143)
49	91.6 (2327)	89.6 (2276)	86.1 (2187)
50	93.4 (2371)	91.4 (2321)	87.9 (2232)
51	95.1 (2416)	93.1 (2365)	89.6 (2276)
52	96.9 (2460)	94.9 (2410)	91.4 (2321)

*Casters add approximately 2" (51 mm) to frame and are factory installed on the cabinet.*

Width Dimensions - in (mm)			
Nominal Depth	Overall with Side Panels	Front Opening	Rack-Mount Panel Width
600	23.6 (600)	19.6 (498)	19 (482.6)
700	27.6 (700)	23.5 (598)	19 (482.6)
800	31.5 (800)	27.5 (698)	19 (482.6)

*Mounting Rail clearance is 17.8" (452 mm). Mounting hole spacing is 18.3" (465 mm).*

Depth Dimensions - in (mm)			
Nominal Depth	Overall with Doors	Frame Only No Doors	Maximum Rail Depth
800	35.4 (900)	31.5 (800)	29.3 (745)
825	36.4 (925)	32.5 (825)	30.3 (770)
850	37.4 (950)	33.5 (850)	31.3 (795)
875	38.4 (975)	34.4 (875)	32.3 (820)
900	39.4 (1000)	35.4 (900)	33.2 (843)
925	40.4 (1025)	36.4 (925)	34.2 (870)
950	41.4 (1050)	37.4 (950)	35.2 (895)
975	42.3 (1075)	38.4 (975)	36.2 (920)
1000	43.3 (1100)	39.4 (1000)	37.2 (945)
1025	44.3 (1125)	40.4 (1025)	38.2 (970)
1050	45.3 (1150)	41.3 (1050)	39.2 (995)
1075	46.3 (1175)	42.3 (1075)	40.1 (1020)
1100	47.3 (1200)	43.3 (1100)	41.1 (1045)
1125	48.2 (1225)	44.3 (1125)	42.1 (1070)
1150	49.2 (1250)	45.3 (1150)	43.1 (1095)
1175	50.2 (1275)	46.3 (1175)	44.1 (1120)
1200	51.2 (1300)	47.2 (1200)	45.1 (1145)

*Front Door is approximately 2.4"D (61 mm), and Rear Door is approximately 1.5"D (38 mm) with hinges/latches. Minimum rail depth is 7" (178 mm), and each rail is 3.5"D (89 mm). Rail depth is reduced when vertical accessories are placed in corners.*

- Use the perforated doors with Aisle Containment Solutions or traditional hot aisle/cold aisle applications. Use the solid rear door with Vertical Exhaust Duct top panels.
- Select a single-point or two-point latch and a keyed or combination lock. Double doors require a two-point latch. If you select a single-point latch and a double rear door, the front door will have a single-point latch, and the rear door will have a two-point latch. All doors must have a latch. The (N) option should only be selected if the cabinet has NO doors. Doors have a swing handle on the exterior. The combination lock uses a 3-digit combination entered on 3-dials that are integrated into the swing handle or a key. The combination lock can be reprogrammed in the field.
- There are three styles of top panel. Network top panels are a one-piece panel with four brush-sealed cable openings, one per corner. Server top panels are for cabinets that are 1050 mm D or deeper that may be upgraded with Vertical Exhaust Duct at a future date. Server top panels are two-piece panels with four brush-sealed cable openings, one per corner. The rear piece of the panel is removed to add a Vertical Exhaust Duct. Vertical Exhaust Duct top panels have two brush-sealed cable openings in the front corners, and the duct at the rear of the cabinet. Choose the duct height range that fits the distance between the top of the cabinet and the drop ceiling. Cabinets with Vertical Exhaust Duct top panels include a bottom panel and airflow director, and must be used with a solid rear door.



Patented  
Vertical Exhaust  
Duct



## Vertical Exhaust Duct

Vertical Exhaust Duct attaches to the top of the cabinet to provide a sealed pathway for hot air from the top of the cabinet to an overhead drop ceiling as part of a closed hot air return.

- Used with Solid Rear Door, Bottom Panel, Air Dam, Snap-In Filler Panels and Air Director to completely contain hot exhaust air and remove it from the cabinet and room
- Fits cabinets that are 41.3" D (1050 mm) or deeper that have a two-piece Server top panel
- Two-piece duct adjusts in height to span the distance between the top of the cabinet and the overhead drop ceiling, available in three sizes (see description in order table)
- Features easy height adjustment, has a flexible seal at the top to accommodate variations in the drop ceiling
- Includes a brush-sealed opening on the back for power cords

Part Number Cabinet Width			Description in (mm)	Shipping Weight lb (kg)
23.6" W (600 mm)	27.6" W (700 mm)	31.5" W (800 mm)		
39177-X00	39177-X03	39177-X06	14-20 (356-508)	17 (7.7)
39177-X01	39177-X04	39177-X07	20-34 (508-863)	25 (11.3)
39177-X02	39177-X05	39177-X08	34-60 (863-1523)	43 (19.5)

X=Color; 7=Black, E=Glacier White. Shipping Weights are 800 mm ducts.



## Bottom Panel

Bottom Panel seals the bottom of the cabinet to contain and control airflow in cabinets that are elevated on casters or leveling feet.

- Solid panel with two brush-sealed cable openings
- Two-piece design for easy installation, adjusts in depth to fit cabinet
- Two cable openings, in back corners, are 4.5" W x 9" D (114 mm x 228 mm) without cover, sized for large power plugs
- Brush covers over cable openings, protects cables as they pass through bottom panel, provides a 3.9" W x 8.8" D (99 mm x 223 mm) pass through area for cables
- Brush cover is two halves that snap together around cables and forms a seal
- Used in combination with Air Dam and Vertical Exhaust Duct
- Fits cabinet frames that are 39.4" D (1000 mm) and deeper

Part Number Cabinet Width			Description in (mm)	Shipping Weight lb (kg)
23.6" W (600 mm)	27.6" W (700 mm)	31.5" W (800 mm)		
39132-X00	39132-X01	39132-X02	≥39.4 (1000)	30 (13.6)

X=Color; C=Black, E=Glacier White. Shipping Weights are 800 mm kits.



## Air Dam Kit

Blocks airflow around the top and sides of equipment. Requires a minimum rail setback of 1.3" (33 mm) from the front of the cabinet frame. Compatible with Bottom Panel. Use with Snap-In Filler Panels.

Part Number - Cabinet Width For 6-Slide Frame Style			Height (U)	Shipping Weight lb (kg)
23.6"W (600 mm)	27.6"W (700 mm)	31.5"W (800 mm)		
39085-X00	39085-X11	39085-X22	42	11 (5.0)
39085-X01	39085-X12	39085-X23	43	11 (5.0)
39085-X02	39085-X13	39085-X24	44	11 (5.0)
39085-X03	39085-X14	39085-X25	45	11 (5.0)
39085-X04	39085-X15	39085-X26	46	12 (5.4)
39085-X05	39085-X16	39085-X27	47	12 (5.4)
39085-X06	39085-X17	39085-X28	48	12 (5.4)
39085-X07	39085-X18	39085-X29	49	12 (5.4)
39085-X08	39085-X19	39085-X30	50	12 (5.4)
39085-X09	39085-X20	39085-X31	51	12 (5.4)
39085-X10	39085-X21	39085-X32	52	13 (5.9)

Part Number - Cabinet Width For 4-Slide Frame Style			Height (U)	Shipping Weight lb (kg)
23.6"W (600 mm)	27.6"W (700 mm)	31.5"W (800 mm)		
39130-X00	39130-X11	39130-X22	42	11 (5.0)
39130-X01	39130-X12	39130-X23	43	11 (5.0)
39130-X02	39130-X13	39130-X24	44	11 (5.0)
39130-X03	39130-X14	39130-X25	45	12 (5.4)
39130-X04	39130-X15	39130-X26	46	12 (5.4)
39130-X05	39130-X16	39130-X27	47	12 (5.4)
39130-X06	39130-X17	39130-X28	48	12 (5.4)
39130-X07	39130-X18	39130-X29	49	12 (5.4)
39130-X08	39130-X19	39130-X30	50	13 (5.9)
39130-X09	39130-X20	39130-X31	51	13 (5.9)
39130-X10	39130-X21	39130-X32	52	13 (5.9)

X=Color, C=Black, E=Glacier White. Shipping Weights are 800 mm kits.

## Snap-In Filler Panel

Snap-In Filler Panel blocks airflow in between equipment by sealing unused rack-mount spaces (U) in the cabinet. Use with Air Dam Kit and Bottom Panel to separate cold and hot air within the cabinet.



Part Number			Height (U)	Shipping Weight lb (kg)
Each (1)	Each (6)	Each (50)		
34537-X00	34537-X01	34537-X02	1U	14 (6.4)
34538-X00	34538-X01	34538-X02	2U	21 (9.5)

X=Color, 0=Black, E=Glacier White. Shipping Weights are for 50 pack.



## Side Panel with Brush Seal Openings

Side Panel with Brush Seal Openings features multiple brush-sealed cable openings that allow cables to enter the side of the cabinet, while containing exhaust air within each cabinet.

- Two-piece design with top and bottom halves for easier handling
- Eight cable openings per side, four per half-height panel, one per corner, are 4.5" W x 9" D (114 mm x 228 mm) without cover, sized for large power plugs
- Brush cover over cable openings protects cables as they pass through the side panel and provides a 3.9" W x 8.8" D (99 mm x 223 mm) pass through area for cables
- Tool-less removal, drop in design with integrated locking spring latch secures the side panel to the cabinet frame
- Integrated grounding tabs to electrically bond the side panel to cabinet frame
- Includes: Side panel (two halves, with brushes), hardware, set of keys

Frame Style		Part Number											Cabinet Frame Depth in (mm)	Shipping Weight lb (kg)
6-Slide	4-Slide	Height (U)												
		42	43	44	45	46	47	48	49	50	51	52		
39047	39043	-X00	-X17	-X34	-X51	-X68	-X85	-XAC	-XAY	-XBU	-XCP	-XDL	31.5 (800)	44 (20.0)
		-X01	-X18	-X35	-X52	-X69	-X86	-XAD	-XBA	-XBV	-XCR	-XDM	32.5 (825)	46 (20.9)
		-X02	-X19	-X36	-X53	-X70	-X87	-XAE	-XBB	-XBW	-XCT	-XDN	33.5 (850)	47 (21.3)
		-X03	-X20	-X37	-X54	-X71	-X88	-XAF	-XBC	-XBY	-XCU	-XDP	34.4 (875)	49 (22.2)
		-X04	-X21	-X38	-X55	-X72	-X89	-XAG	-XBD	-XCA	-XCV	-XDR	35.4 (900)	50 (22.7)
		-X05	-X22	-X39	-X56	-X73	-X90	-XAH	-XBE	-XCB	-XCW	-XDT	36.4 (925)	52 (23.6)
		-X06	-X23	-X40	-X57	-X74	-X91	-XAJ	-XBF	-XCC	-XCY	-XDU	37.4 (950)	53 (24.0)
		-X07	-X24	-X41	-X58	-X75	-X92	-XAK	-XBG	-XCD	-XDA	-XDV	38.4 (975)	55 (24.9)
		-X08	-X25	-X42	-X59	-X76	-X93	-XAL	-XBH	-XCE	-XDB	-XDW	39.4 (1000)	56 (25.4)
		-X09	-X26	-X43	-X60	-X77	-X94	-XAM	-XBJ	-XCF	-XDC	-XDY	40.4 (1025)	58 (26.3)
		-X10	-X27	-X44	-X61	-X78	-X95	-XAN	-XBK	-XCG	-XDD	-XEA	41.3 (1050)	59 (26.8)
		-X11	-X28	-X45	-X62	-X79	-X96	-XAP	-XBL	-XCH	-XDE	-XEB	42.3 (1075)	61 (27.7)
		-X12	-X29	-X46	-X63	-X80	-X97	-XAR	-XBM	-XCJ	-XDF	-XEC	43.3 (1100)	62 (28.1)
		-X13	-X30	-X47	-X64	-X81	-X98	-XAT	-XBN	-XCK	-XDG	-XED	44.3 (1125)	64 (29.0)
		-X14	-X31	-X48	-X65	-X82	-X99	-XAU	-XBP	-XCL	-XDH	-XEE	45.3 (1150)	65 (29.5)
		-X15	-X32	-X49	-X66	-X83	-XAA	-XAV	-XBR	-XCM	-XDJ	-XEF	46.3 (1175)	67 (30.4)
-X16	-X33	-X50	-X67	-X84	-XAB	-XAW	-XBT	-XCN	-XDK	-XEG	47.2 (1200)	68 (30.8)		

X=Color: C=Black, E=Glacier White. Shipping Weights are for 4-Slide, 52U panels. 6-Slide panels are approximately 8 lb (3.6 kg) lighter.



## Front-to-Rear Cable Manager

Front-to-Rear Cable Manager attaches to the back of equipment mounting rails, creating a front-to-rear pathway between the front and rear mounting rails for cables.

- For use on 27.6" W (700 mm) and 31.5" W (800 mm) cabinets
- Mounting locations behind cable openings on each rail
- Attaches to mounting rails and extends to match depth
- Creates a 2.5" W (64 mm) x 3" D (78 mm) front-to-rear pathway for cables

Part Number – Cabinet Width			Rail Depth Range in (mm)	Shipping Weight lb (kg)
23.6" W (600 mm)	27.6" W (700 mm)	31.5" W (800 mm)		
N/A	39077-X00	39077-X00	22-34 (558-863)	5 (2.3)

X=Color: C=Black, E=Glacier White.

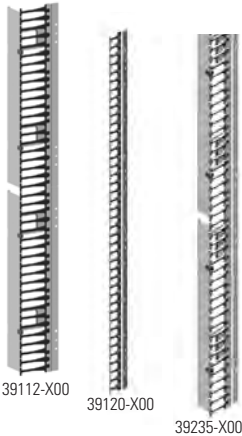

## Finger Cable Manager

Finger Cable Manager attaches to the equipment mounting rail, creating a pathway for cables next to the rail and includes plastic T-shaped cable guides (fingers) that organize cables by rack-mount space (U).

- Attaches to and adjusts with mounting rails, fully compatible with Air Dam
- Plastic, T-shaped cable guides organize cables by rack-mount space (U)
- Openings between cable guides (fingers) align with each rack-mount space on the mounting rail
- Pass up to 48 cables per U space through openings on the Finger Cable Manager. Pass up to 24 cables per U space through openings on the Finger Cable Manager, Short
- Hinged cover included with managers in wider cabinets, cover snaps closed to secure cables
- Includes: finger cable manager, cover (wider cabinets only), installation hardware. Material: Steel panels, plastic guides and latches
- Select part number to match the width, usable height and color of the cabinet

Inside Dimensions, Usable Internal Cable Area, Rails Setback				
Cabinet Width	Width in (mm)	Depth in (mm)	Cable Area in <sup>2</sup> (mm <sup>2</sup> )	Rail Setback in (mm)
Finger Cable Manager				
27.6 (700)	2.6 (66)	8.4 (213)	21.8 (14 060)	10.1 (257)
31.5 (800)	4.6 (117)	8.4 (213)	38.6 (24 900)	10.1 (257)
Finger Cable Manager, Short				
23.6 (600)	.5 (13)	6.0 (150)	3 (1900)	7.6 (193)
27.6 (700)	2.6 (66)	6.0 (150)	15.6 (10 060)	7.6 (193)
31.5 (800)	4.6 (117)	6.0 (150)	27.8 (17 940)	7.6 (193)

Rail setback is the minimum distance required between the front edge of the cabinet frame and the front edge of the equipment mounting rail.

Part Number – Cabinet Width			Height in (mm)	Shipping Weight lb (kg)
23.6" W (600 mm)	27.6" W (700 mm)	31.5" W (800 mm)		
Finger Cable Manager				
N/A	39112-X11	39112-X22	42	22 (10.0)
N/A	39112-X12	39112-X23	43	22 (10.0)
N/A	39112-X13	39112-X24	44	22 (10.0)
N/A	39112-X14	39112-X25	45	23 (10.4)
N/A	39112-X15	39112-X26	46	23 (10.4)
N/A	39112-X16	39112-X27	47	23 (10.4)
N/A	39112-X17	39112-X28	48	25 (11.3)
N/A	39112-X18	39112-X29	49	25 (11.3)
N/A	39112-X19	39112-X30	50	25 (11.3)
N/A	39112-X20	39112-X31	51	26 (11.8)
N/A	39112-X21	39112-X32	52	26 (11.8)
Finger Cable Manager, Short				
39120-X00	39235-X11	39235-X22	42	21 (9.5)
39120-X01	39235-X12	39235-X23	43	21 (9.5)
39120-X02	39235-X13	39235-X24	44	21 (9.5)
39120-X03	39235-X14	39235-X25	45	22 (10.0)
39120-X04	39235-X15	39235-X26	46	22 (10.0)
39120-X05	39235-X16	39235-X27	47	22 (10.0)
39120-X06	39235-X17	39235-X28	48	23 (10.4)
39120-X07	39235-X18	39235-X29	49	23 (10.4)
39120-X08	39235-X19	39235-X30	50	23 (10.4)
39120-X09	39235-X20	39235-X31	51	24 (10.9)
39120-X10	39235-X21	39235-X32	52	24 (10.9)

X= color: C=Black, E=Glacier White. Shipping Weights are for 800 mm kits.



## Full Height PDU Bracket

Full Height PDU Bracket supports two vertical PDUs side-by-side and has multiple slots for CPI Saf-T-Grip® Straps or tie wraps to secure cords to the bracket. Two sizes available, Dual and Wide.

- Attaches to the frame, adjusts in depth independent of the mounting rails
- Dual is 4.8"W (121 mm) and supports two 2.2"W (51 mm) PDUs side-by-side
- Wide is 5.8"W (147 mm) and supports two 2.7"W (69 mm) PDUs side-by-side. Use wide for all 6-breaker PDUs and International Power Strips
- Tool-less mounting on 61.25" (1556 mm) or 64.75" (1645 mm) centers
- Bracket is 4.8"W (121 mm). Order Saf-T-Grips or cable ties separately

Part Number		Height (U)	Shipping Weight lb (kg)
Dual	Wide		
39086-X00	39221-X00	42	9 (4.1)
39086-X01	39221-X01	43	9 (4.1)
39086-X02	39221-X02	44	9 (4.1)
39086-X03	39221-X03	45	10 (4.5)
39086-X04	39221-X04	46	10 (4.5)
39086-X05	39221-X05	47	10 (4.5)
39086-X06	39221-X06	48	10 (4.5)
39086-X07	39221-X07	49	11 (5.0)
39086-X08	39221-X08	50	11 (5.0)
39086-X09	39221-X09	51	11 (5.0)
39086-X10	39221-X10	52	11 (5.0)

X=color: C=Black, E=Glacier White.

## Cable Lashing Bracket

Cable Lashing Bracket creates a simple, separate vertical pathway for a small bundle of cables and has multiple slots for CPI Saf-T-Grip® Straps or tie wraps to secure cables to the bracket.

- Attaches to the frame, adjusts in depth independent of the mounting rails
- Bracket is 1.6"W (41 mm), order Saf-T-Grips or cable ties separately

Part Number - Frame Style		Height (U)	Shipping Weight lb (kg)
6-Slide	4-Slide		
39124-X00	39131-X00	42	4 (1.8)
39124-X01	39131-X01	43	4 (1.8)
39124-X02	39131-X02	44	4 (1.8)
39124-X03	39131-X03	45	5 (2.3)
39124-X04	39131-X04	46	5 (2.3)
39124-X05	39131-X05	47	5 (2.3)
39124-X06	39131-X06	48	5 (2.3)
39124-X07	39131-X07	49	5 (2.3)
39124-X08	39131-X08	50	5 (2.3)
39124-X09	39131-X09	51	5 (2.3)
39124-X10	39131-X10	52	5 (2.3)

X=color: C=Black, E=Glacier White.

## Ring Cable Manager

Ring Cable Manager is independent of the equipment mounting rails, creating a separate vertical pathway for cables and includes plastic cable rings to organize cables.

- Attaches to the frame, adjusts in depth independent of the mounting rails
- Rings have an opening on the front for easy addition or removal of cables
- Includes: brackets, rings, installation hardware



Part Number - Cabinet Width For 6-Slide Frame Style			Height (U)	Shipping Weight lb (kg)
23.6" W (600 mm)	27.6" W (700 mm)	31.5" W (800 mm)		
39087-X00	39088-X00	39089-X00	42	13 (5.9)
39087-X01	39088-X01	39089-X01	43	13 (5.9)
39087-X02	39088-X02	39089-X02	44	13 (5.9)
39087-X03	39088-X03	39089-X03	45	14 (6.4)
39087-X04	39088-X04	39089-X04	46	14 (6.4)
39087-X05	39088-X05	39089-X05	47	14 (6.4)
39087-X06	39088-X06	39089-X06	48	14 (6.4)
39087-X07	39088-X07	39089-X07	49	14 (6.4)
39087-X08	39088-X08	39089-X08	50	15 (6.8)
39087-X09	39088-X09	39089-X09	51	15 (6.8)
39087-X10	39088-X10	39089-X10	52	15 (6.8)
Part Number - Cabinet Width For 4-Slide Frame Style			Height (U)	Shipping Weight lb (kg)
23.6" W (600 mm)	27.6" W (700 mm)	31.5" W (800 mm)		
39127-X00	39128-X00	39129-X00	42	14 (6.4)
39127-X01	39128-X01	39129-X01	43	14 (6.4)
39127-X02	39128-X02	39129-X02	44	14 (6.4)
39127-X03	39128-X03	39129-X03	45	14 (6.4)
39127-X04	39128-X04	39129-X04	46	14 (6.4)
39127-X05	39128-X05	39129-X05	47	15 (6.8)
39127-X06	39128-X06	39129-X06	48	15 (6.8)
39127-X07	39128-X07	39129-X07	49	15 (6.8)
39127-X08	39128-X08	39129-X08	50	15 (6.8)
39127-X09	39128-X09	39129-X09	51	15 (6.8)
39127-X10	39128-X10	39129-X10	52	15 (6.8)

X=Color; C=Black, E=Glacier White. Shipping Weights are 800 mm kits.

Ring Manager Rail Setback Table on right.  
Note: Rail setback is the minimum distance required between the front edge of the cabinet frame and the front edge of the equipment mounting rail.

Inside Dimensions, Usable Internal Cable Area, Rails Setback					
Cabin Width	Width in (mm)	Depth in (mm)	Cable Area in <sup>2</sup> (mm <sup>2</sup> )	Rail Setback in (mm) 6-Slide	Rail Setback in (mm) 4-Slide
23.6 (600)	.9 (29)	3.3 (84)	2.9 (1870)	7.6 (193)	9.1 (231)
27.6 (700)	2.3 (58)	5.5 (140)	12.6 (8130)	8.2 (208)	8.2 (208)
31.5 (800)	4.2 (107)	3.5 (89)	14.7 (9480)	6.4 (163)	6.4 (163)



## Electronic Lock Kit

Electronic Lock Kit is a retrofit kit for the cabinet door that enhances security by eliminating the need for keys and allowing quick lock reprogramming if there is a security concern. Each lock can be programmed with multiple access codes, allowing assignment of administrator and user only rights. Use a master code to open all cabinets, while different user codes open individual cabinets or groups of cabinets.

- Standalone electronic keypad lock (not networked, no audit trail)
- Two options: System 1000 or System 1500
- Three user levels with programmable access codes:
  - Master code (8-digit) – full administrative rights
  - Sub-Master code (8-digit) – set/delete user code
  - User code (4-digit)
- System 1000 supports 3 access codes (1 master, 1 sub-master, 1 user), approximately 15,000 openings with new 2 x 1.5 VDC AAA batteries and has a silver-colored handle with black mounting plate
- System 1500 supports 22 access codes (1 master, 1 sub-master, 20 user), approximately 50,000 openings with new 2 x 3 VDC CR2450 coin batteries, has an audible keypad, dual access code mode and black handle and mounting plate

Part Number - By Door Style For Doors with a Single-Point Latch			Description	Shipping Weight lb (kg)
Front Door Single, Perf	Rear Door Single, Solid	Rear Door Double, Perf		
39222-C00	39223-C00	N/A	System 1000	3 (1.4)
39222-C01	39223-C01	N/A	System 1500	3 (1.4)

Part Number - By Door Style For Doors with a Two-Point Latch			Description	Shipping Weight lb (kg)
Front Door Single, Perf	Rear Door Single, Solid	Rear Door Double, Perf		
39226-C99	39227-C99	39225-C99	System 1000	3 (1.4)
39229-C99	39230-C99	39228-C99	System 1500	3 (1.4)

Note: These part numbers are retrofit electronic lock kits that replace the swing handle on the cabinet door of an F-Series TeraFrame Gen 3 Cabinet. To order this lock kit pre-installed on the cabinet door, use the CPI Product Configurator for the F-Series TeraFrame Gen 3 Cabinet on the CPI website.

## The F-Series TeraFrame® HD Cabinet System

Metric footprint for international use

Available in 600 mm width, three heights and two depths

Includes two pairs of sliding, continuously adjustable equipment mounting rails to provide front and rear support for 19"W (482.6 mm) EIA/ECA-310-E compliant rack-mount equipment and shelves

Mounting rails have 1.75"H (44.45 mm) rack-mount units and are available with square-punched holes that accept cage nuts; rack-mount units are marked and numbered bottom-to-top on all rails

Includes a single-point cam latch with keyed locks

Includes a single, perforated, curved metal front door (79% open); reversible to open from the right or left, easy to remove at 90° open position

Open base for cable entry; includes leveling feet and heavy-duty casters with roller bearings for superior, long-term performance

A bottom panel is available as an accessory



Choose a solid top panel with two (server-style) brush-sealed network cable access ports, or use the Vertical Exhaust Duct option with high heat density applications to isolate and remove hot air from the room

Heavy-duty, welded steel and bolted aluminum frame construction supports up to 3000 lb (1360.0 kg) of equipment in a dynamic environment

Easy to remove solid side panels have recessed spring-loaded latches with keyed locks; cabinets can be bayed (side-by-side) with side panels installed

Choose a solid metal, perforated metal or double, perforated metal rear door

The mounting rails, top panel, side panels and doors are electrically bonded to the cabinet frame; a ground terminal block is included to attach the frame to the CBN or TGB

Organize network cables, power distribution units and power cords along the sides of the cabinet with optional side-mounted vertical cable and power managers

Heavy-duty shock pallet and reusable cushioned carton allow the cabinet to be reshipped after equipment is installed

Heavy-duty welded steel ramp provides a safe method for unloading the cabinet from the pallet upon arrival at customer site

**Static & dynamic load rating of 3000 lb (1360 kg)**





## F-Series TeraFrame® HD Cabinet System

The F-Series TeraFrame® HD Cabinet System is designed for safe transportation of up to 3000 lb (1360 kg) of electronic equipment from a factory integration site, direct to the customer's data center.

Every cabinet includes two pairs of sliding, continuously adjustable equipment mounting rails with square-punched mounting holes for compatibility with most rack-mount equipment. In addition, the F-Series TeraFrame HD Cabinet system includes heavy duty casters with roller bearings for superior long-term performance under load, a shock pallet and a reusable cushioned carton for protection during shipment.

The top panel includes large brush-covered cable openings that will handle large bundles of cables, while preventing undesirable hot air recirculation. The top panel includes a removable cover plate, allowing the use of a Vertical Exhaust Duct for high-density applications. Cabinets include solid side panels to protect equipment.

Heavy-duty steel ramp is an optional accessory designed to simplify unloading the populated cabinet from the shock pallet. An optional bolt-down kit allows the cabinet to be securely anchored to the floor structure and can be installed prior to the cabinet's arrival to minimize installation time. Combine the F-Series TeraFrame HD Cabinet with thermal and cable management accessories to create a custom solution that fits your exact needs.

### Cabinet Specifications:

- Available in 600 mm width, 3 heights and 2 depths
- Provides front and rear support for 19" W EIA equipment and shelves, with two pairs of adjustable depth rack-mount unit marked and numbered equipment mounting rails
- Includes grounding and bonding kit
- Includes leveling feet and casters
- Can be ordered with a server top panel or Vertical Exhaust Duct
- Choose from three rear door styles
- Heavy-duty welded steel and bolted aluminum frame construction
- Load rating:
  - 3000 lb (1360 kg) static
  - 3000 lb (1360 kg) dynamic

### Cabinet Includes:

- (1) Four-post frame (painted finish)
- (4) Vertical Mounting Rails (square-punched)
- (1) Grounding/Bonding Kit
- (2) Locking, Solid Side Panels
- (1) Front Door
- (1) Rear Door
- (1) Top Panel
- (4) Leveling Feet and casters
- (1) Bag of 25 Each M6 Cage Nuts and Screws (square-punched rails)
- (1) Shock pallet rated for 3000 lb of equipment (excluding cabinet weight)
- (1) Reusable cushioned carton

# F-SERIES TERAFRAME® HD CABINET SYSTEM

Use the part number matrix below to select a F-Series TeraFrame HD Cabinet. Choose the **Height**, **Width**, **Depth**, **Rail Style**, **Front Door**, **Rear Door**, **Latch**, **Color**, **Top Panel** and **Side Panel** style to form a part number. To order the cabinet with accessories installed, contact CPI Technical Support. **Example Cabinet Part Number: FHD-F1U-111B-C52**

FHD - H W D - R FD RD L - C TP SP

1. Height					
Cabinet		Frame		U	
in	mm	in	mm		
82.5	2096	78.1	1984	42	C
87.7	2228	83.4	2118	45	F
91.2	2316	86.9	2207	47	H

*Cabinet height includes casters.*

2. Width					
Cabinet		EIA	Frame		
in	mm		in	mm	
23.6	600	19"	23.4	594	1

3. Depth					
Cabinet		Rails		Frame	
in	mm	in	mm	in	mm
46.1	1172	39.4	1001	42.3	1075
51.0	1297	44.3	1126	47.2	1200

4. Rail Style	
Square-Punched, 2-Pair	1

5. Front Door	
1	Single, Perforated Metal

6. Rear Door	
1	Single, Solid Metal
2	Single, Perforated Metal
3	Double, Perforated Metal

7. Latch/Locks Kits	
B	Single-Point, Keyed Lock

*The rear double-door will have a two-point latch.*

8. Color	
C	Black

9. Top Panel Style	
4	Server, 2 Cable Openings
5	Vertical Exhaust Duct, 20"-34"H (508-863 mm)
6	Vertical Exhaust Duct, 34"-60"H (863-1523 mm)

*Use a solid rear door with ducted options.*

10. Side Panel Style	
2	Solid, 2 each

## Notes:

- Height: Three heights are available. The cabinet height is the overall height of the cabinet with a top panel and casters. The frame height is the height of the internal frame without the top panel or casters. Casters add approximately 4.2 inches (107 mm) to the height of the frame and cabinet.
- Width: Overall cabinet width with side panels is 23.6 inches (600 mm). The cabinet includes equipment mounting rails spaced for 19" EIA (482.6 mm) rack-mount equipment.
- Depth: Two depths are available. Cabinet depth is the overall depth of the cabinet including doors. Frame depth is the outside depth of the frame excluding doors. Doors add approximately 3.8 inches (97 mm) to overall depth. Rail depth is the maximum front-to-rear spacing of equipment mounting rails. Rail depth is reduced by an equipment mounting rail setback when accessories are added.
- Rail Style: Square-punched rails use snap-in cage nut hardware that can be changed to match equipment requirements. Order additional mounting hardware as required.
- Front Door Style: The door matches the color of the cabinet and includes an anodized aluminum center beam.
- Rear Door Style: Three rear door styles are available. The double-door reduces the amount of aisle space required to access the rear of the cabinet. Double doors have two-point latches. A single solid metal door must be used when the Vertical Exhaust Duct System top panel style is selected.
- Latches: All doors have a swing handle. Single doors have a single-point cam latch with keyed lock; the double-door has a two-point cam latch with keyed lock. The keyed lock includes a physical key, which matches the locks on the doors and side panels.
- Color: The frame, doors, side panels and top panel are painted black. Mounting rails are zinc plated.
- Top Panel Style: There are two styles of top panels available. Server Top Panels have two large brush-sealed cable openings, and include a removable cover plate for the Vertical Exhaust Duct. The Vertical Exhaust Duct System includes a Server Top Panel, a top-mount Vertical Exhaust Duct, an Airflow Director and a Rear Door Sealing Kit. Select from duct height ranges: 20" to 34" (508 mm – 863 mm) or 34" to 60" (863 mm – 1523 mm) high to match ceiling height. Use with a single solid rear door.
- Side Panel Style: Side panels are solid. Cabinets are bayed with side panels installed. Order baying kits separately.

### TeraFrame HD Cabinet Accessories

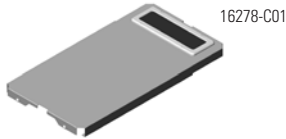
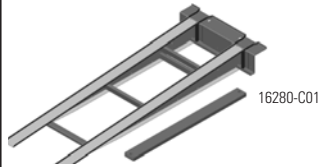

Part Number	Description	Shipping Weight lb (kg)
16280-C01	Unloading Ramp	185 (83.9)
16279-C01	Bolt Down Kit	14 (6.4)
16277-C11	Side Skirt, For 42.3 (1075)	6 (2.7)
16277-C16	Side Skirt, For 47.2 (1200)	6 (2.7)
16271-C02	Baying/Fascia Kit, For 42U Cabinets	10 (4.5)
16271-C05	Baying/Fascia Kit, For 45U Cabinets	10 (4.5)
16271-C07	Baying/Fascia Kit, For 47U Cabinets	10 (4.5)
16270-C02	Air Dam Kit, For 42U Cabinets	12 (5.4)
16270-C05	Air Dam Kit, For 45U Cabinets	13 (5.9)
16270-C07	Air Dam Kit, For 47U Cabinets	13 (5.9)
16278-C01	Bottom Panel	19 (8.6)
16272-C02	Cable Lashing Bar, For 42U Cabinets	7 (3.2)
16272-C05	Cable Lashing Bar, For 45U Cabinets	8 (3.6)
16272-C07	Cable Lashing Bar, For 47U Cabinets	8 (3.6)
16273-C02	Cable Lashing Bracket, For 42U Cabinets	12 (5.4)
16273-C05	Cable Lashing Bracket, For 45U Cabinets	13 (5.9)
16273-C07	Cable Lashing Bracket, For 47U Cabinets	14 (6.4)
16274-C02	Power Strip Bracket, For 42U Cabinets	14 (6.4)
16274-C05	Power Strip Bracket, For 45U Cabinets	15 (8.8)
16274-C07	Power Strip Bracket, For 47U Cabinets	16 (7.3)
16275-C02	Cable Ring Manager, For 42U Cabinets	5 (2.3)
16275-C05	Cable Ring Manager, For 45U Cabinets	5 (2.3)
16275-C07	Cable Ring Manager, For 47U Cabinets	6 (2.7)

Color is black. Power Strip Bracket (-C05) or taller bracket required for 68.5"H (1740 mm) and 70.5"H (1791 mm) PDUs.



## The N-Series TeraFrame® Gen 3 Network Cabinet

Includes large cable entry ports on the top panel, T-shaped cable guides on the front mounting rails and a front-to-rear cable manager to organize cables; vertical cable managers are available as accessories.

Dual slides provide maximum flexibility for mounting and positioning vertical cable management accessories and attaching overhead cable pathway and containment structures.

Frame design provides maximum flexibility for mounting equipment, thermal, cable and power management accessories.

Highly flexible side intake duct that can be adjusted on-site to accommodate a range of switch sizes and manufacturers.

Allows for different size switches to be deployed simultaneously in the same cabinet without additional accessory kits.

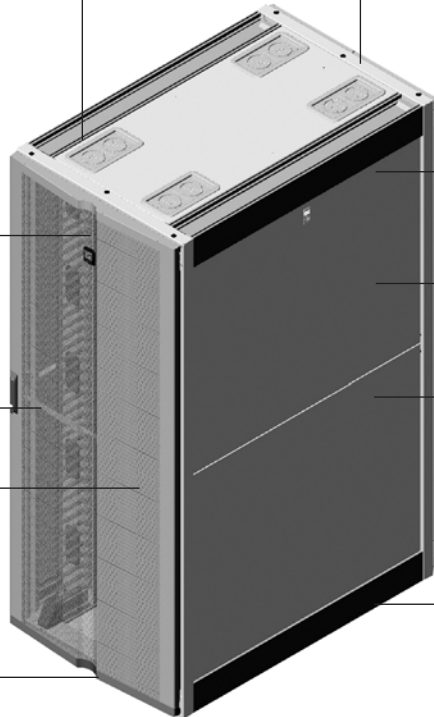

Supports CPI Aisle Containment Solution and has a Vertical Exhaust Duct option available to maintain your data center Aisle Containment strategy.

Frames support up to 2500 lb (1134 kg), static load on leveling feet per UL 2416.

Air Dams - Order the cabinet configured with Air Dams to create front-to-rear or front-to-top airflow.

Side Intake Duct - Order the cabinet configured with Side Intake Duct to create side-to-rear or side-to-top airflow.

Bottom panel - Included with cabinets that have an Air Manager or Vertical Exhaust Duct top panel.

**Engineered solution designed for high-density network and storage switches and cabling. Provides complete separation of hot and cold air within the cabinet to expand your data center aisle containment strategy to your network infrastructure.**

# N-SERIES TERAFRAME® GEN 3 NETWORK CABINET

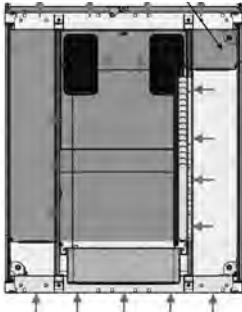

Order the cabinet with a Side Intake Duct when deploying network switches that require side airflow. Use with Snap-In Filler Panels to provide complete front/rear cold/hot air separation within the cabinet.

## N-Series TeraFrame® Gen 3 Network Cabinet

The N-Series TeraFrame® Gen 3 Cabinet System is a network cabinet engineered for high-density cable and thermal management. Network cabinets are unique from server cabinets because they must manage large quantities of cables at both the front and rear of the cabinet, as well as control a mix of front-to-rear and side-to-side airflow through equipment.

To manage network cables, the cabinet includes plastic T-shaped cable management guides (fingers) attached to the front pair of equipment mounting rails with openings that align with each rack mount space (U) for patch cords, and a front-to-back cable manager along the side. Additionally, there is a large, full depth cable opening above both sides of the cabinet covered by a brush-sealed or plastic grommet to block bypass airflow.

To control airflow for switches, the cabinet offers a Vertical Exhaust Duct or perforated rear doors, as well as integrated internal air dams in four standard pre-configured solutions: front-to-rear, front-to-top, side-to-rear or side-to-top airflow. Front-to-rear airflow includes air dams that block airflow around equipment and perforated rear doors, so hot air exits the rear of the cabinet. Front-to-top airflow includes a bottom panel, solid rear door and Vertical Exhaust Duct, so hot air exits the top of the cabinet. Side airflow combines a front air dam and a side intake duct. The side intake duct is a full height plastic panel that is trimmed to match the intake on the switch, a universal solution that does not require you to know which switch will be used. Side-to-top airflow combines the Vertical Exhaust Duct kit, air dam and side intake duct with a partially perforated rear door. Cold air enters the front or rear of the cabinet to provide additional cold air for high-density switches, and hot air exits the top of the cabinet.

### Cabinet Specifications:

- Available in multiple heights, widths and depths
- Available with integrated cable and thermal management accessories to meet front-to-rear and side airflow requirements
- Includes two pairs of mounting rails in the cabinet; Adjustable depth, rails slide front-to-back, marks on the frame for easy vertical alignment
- Static load rating: 2500 (1134 kg) on leveling feet

### Cabinet Includes:

- (1) Welded steel and bolted aluminum four-post Frame
- (2) Equipment Mounting Rails, Pairs
- (1) Perforated Front Door with Swing Handle
- (1) Solid, Perforated or partially Perforated Rear Door options
- (1) Top Panel, two full-depth brush sealed or grommeted cable openings
- (4) Leveler Feet, Transport Casters and Floor attachment brackets
- (1) Ground System and Ground Lug
- (1) Baying Kit
- (1) PDU brackets, one pair, for two 2.2"W (56 mm) vertical CPI PDUs
- (1) Bag of 25 Each M6 Cage Nuts and Screws (square-punched rails)
- (1) Bag of 50 Each #12-24 Rack Channel Mounting Screws (tapped rails)
- Certifications:
  - EIA-310-E compliant
  - UL Listed 2416, NWIN, File #E227626

# N-SERIES TERAFRAME® GEN 3 NETWORK CABINET

Use the part number matrix below to configure a N-Series TeraFrame Gen 3 Cabinet. Choose the **Height**, **With** or **Without** Duct, **Depth**, **Rail** Style, **Front Door**, **Rear Door**, **Latch**, **Color**, **Top Panel** Style, **Side Panel** Style and **Cable Entry** Style. **Example Cabinet Part Number: NF5U-114C-E52-1.**

**N H W D - R F R L - C T S - E**

1. Height			
in	mm	U	C
78.1	1984	42	<b>C</b>
79.9	2029	43	<b>D</b>
81.6	2073	44	<b>E</b>
83.4	2117	45	<b>F</b>
85.1	2162	46	<b>G</b>
86.9	2206	47	<b>H</b>
88.6	2251	48	<b>J</b>
90.4	2295	49	<b>K</b>
92.1	2340	50	<b>L</b>
93.9	2384	51	<b>M</b>
95.6	2429	52	<b>N</b>

Height includes transport casters.

2. Width		Included	
in	mm	Air Manager	
31.5	800	No Air Manager	<b>0</b>
31.5	800	Front Air Dams	<b>7</b>
31.5	800	Side Intake Duct	<b>1</b>
40.0	1016	No Air Manager	<b>6</b>
40.0	1016	Front Air Dams	<b>8</b>
40.0	1016	Side Intake Duct	<b>5</b>

40.0"W (1016 mm) cabinets are only available 44.3"D (1100 mm) or deeper.

3. Depth		With Doors		
in	mm	in	mm	
39.4	1000	43.3	1100	<b>J</b>
40.4	1025	44.3	1125	<b>K</b>
41.3	1050	45.3	1150	<b>L</b>
42.3	1075	46.3	1175	<b>M</b>
43.3	1100	47.3	1200	<b>N</b>
44.3	1125	48.2	1225	<b>P</b>
45.3	1150	49.2	1250	<b>R</b>
46.3	1175	50.2	1275	<b>T</b>
47.2	1200	51.2	1300	<b>U</b>

Frame Depth does not include doors. Front door adds 2.4" (61 mm). Rear door adds 1.5" (38 mm).

4. Equipment Mounting Rail Style	
Square Punch, 2 Pair	<b>1</b>
Tapped, #12-24, Pair	<b>2</b>

11. Cable Entry Cover	
<b>0</b>	Plastic Grommet
<b>1</b>	Brush Sealed

10. Side Panel Style	
<b>0</b>	None
<b>1</b>	Solid, 1 each
<b>2</b>	Solid, 2 each

Include side panels on all cabinets with Front Air Dams or Side Intake Duct Air Managers.

9. Top Panel	
<b>4</b>	Standard Top
<b>5</b>	Vertical Exhaust Duct, 20"-34"H (508-863 mm)
<b>6</b>	Vertical Exhaust Duct, 34"-60"H (863-1523 mm)
<b>7</b>	Vertical Exhaust Duct, 14"-20"H (356-508 mm)

Options 5, 6, & 7 are for cabinets that are 41.3"D (1050 mm) or deeper. Use Solid Metal Rear Door or Solid Metal with Perforated Insert Rear Door with Vertical Exhaust Duct. Vertical Exhaust Duct includes a Bottom Panel.

8. Color	
<b>C</b>	Black
<b>E</b>	Glacier White

7. Latch/Lock Kits	
<b>C</b>	Two-Point, Keyed Lock
<b>E</b>	Two-Point, Cam Latch, Combination Lock
<b>N</b>	None

There is a single-point latch on front door that matches GF-Series GlobalFrame Gen 2 Cabinet.

6. Rear Door Style	
<b>0</b>	None
<b>1</b>	Double, Perforated Metal
<b>4</b>	Solid Metal with Perforated Insert
<b>5</b>	Solid Metal

Use Double Perforated Metal door with Standard Top Panel. Use Solid Metal with Perforated Insert with Vertical Exhaust Duct and Side Intake Duct. Use Solid Metal door with Vertical Exhaust Duct and Air Dams. Solid Metal with Perforated Insert and Solid Metal doors are single doors on the 31.5"W (800 mm) cabinet and double doors on the 40.0"W (1016 mm) cabinet.

5. Front Door Style	
<b>0</b>	None
<b>1</b>	Perforated Metal, matches F-Series TeraFrame Gen 3 Cabinet
<b>2</b>	Perforated Metal, matches GF-Series GlobalFrame Gen 2 Cabinet

Single door on the 31.5"W (800 mm). Double door on the 40.0"W (1016 mm).



Log on to the CPI Product Configurator [www.chatsworth.com/configurator](http://www.chatsworth.com/configurator) to create your cabinet part number.

# N-SERIES TERAFRAME® GEN 3 NETWORK CABINET

## Ordering Notes:

1. Height, Widths, Depths: See tables below for detailed dimensions.
2. Width/Included Air Manager: Order your cabinet configured with internal air managers to support front-to-rear airflow or side airflow. See the next page for standard air manager, rear door and top panel configurations.
7. Latch/Lock Kits: There is a single-point latch on the front door that matches GF-Series GlobalFrame Gen 2 Cabinet.
10. Side Panel Style: Include side panels on all cabinets with Front Air Dams and Side Intake Duct Air Managers.
11. Cable Entry Cover: N-Series Cabinet has front-to-rear cable openings along both sides of the cabinet. Cable Entry Cover identifies the type of cover included with the cabinet to seal the openings. The Plastic Grommet is a solid plastic grommet that can be cut to pass cables. The Brush Sealed cover forms around cables. All cabinets include covers at the top of the cabinet. Cabinets that include Front Air Dams or Side Intake Duct Air Managers have covers at the bottom of the cabinet also.

## Specifications:

Top View

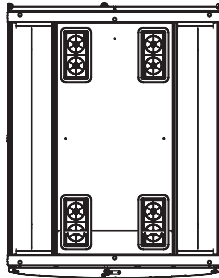

Front View

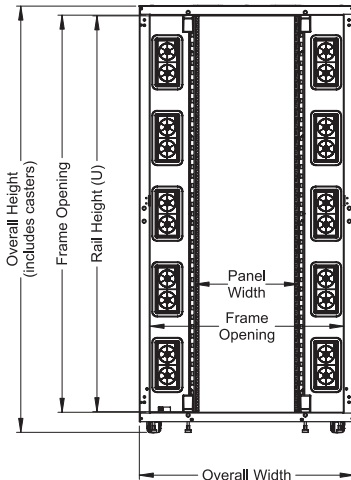

Side View

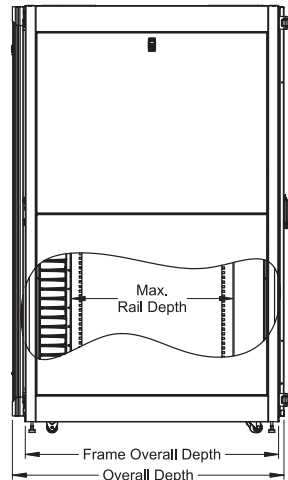

## Cabinet Example Configurations:



**Front-To-Rear Airflow - Example P/N: NX7X-XX3X-X4X-X**  
 Combine Front Air Dams with Perforated Rear Door and Standard Top Panel. Front Air Dams block airflow around the sides of equipment.

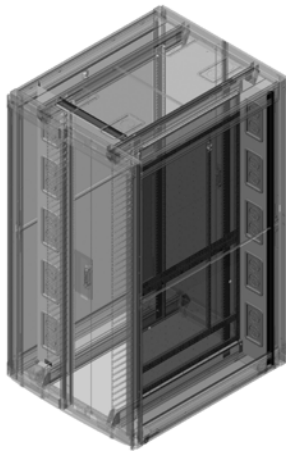

**Side-To-Rear Airflow - Example P/N: NX5X-XX3X-X4X-X**  
 Combine Side Intake Duct with Perforated Rear Door and Standard Top Panel. Side Intake Duct allows cold air to enter either side of a switch.



**Front-To-Top Airflow - Example P/N: NX7X-XX5X-X5X-X**  
 Combine Front Air Dams with Solid Metal Rear Door and Vertical Exhaust Duct Top Panel to remove hot air through the top of the cabinet.

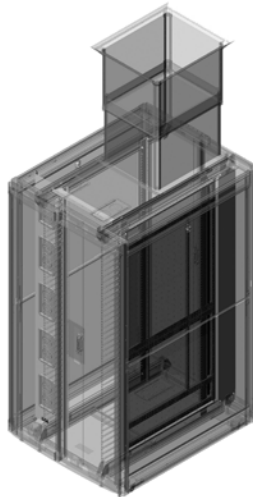

**Side-To-Top Airflow - Example P/N: NX5X-XX4X-X5X-X**  
 Combine Side Intake Duct with Solid Metal Rear Door with Perforated Insert and Vertical Exhaust Duct Top Panel. Side airflow; top exhaust.





## Ring Cable Manager

Ring Cable Manager creates a simple vertical pathway for patch and jumper cords. Use to support cords near the front of the cabinet.

- Attaches to the frame, adjusts in depth independent of the equipment mounting rails
- Rings have an opening on the front for easy addition and removal of cables
- Includes: bracket, rings and installation hardware
- Material: Steel bracket, plastic rings
- Select part number to match the width, usable height and color of the cabinet

Part Number – Cabinet Width		Height (U)	Shipping Weight lb (kg)
31.5"W (800 mm)	40.0"W (1016 mm)		
39128-X00	39129-X00	42	14 (6.4)
39128-X01	39129-X01	43	14 (6.4)
39128-X02	39129-X02	44	14 (6.4)
39128-X03	39129-X03	45	14 (6.4)
39128-X04	39129-X03	46	14 (6.4)
39128-X05	39129-X05	47	15 (6.8)
39128-X06	39129-X06	48	15 (6.8)
39128-X07	39129-X07	49	15 (6.8)
39128-X08	39129-X08	50	15 (6.8)
39128-X09	39129-X09	51	15 (6.8)
39128-X10	39129-X10	52	15 (6.8)

*X=color, C=Black, E=Glacier White. Shipping Weights are for 40.0"W (1016 mm) managers.*

*Cabinet Notes: Use Snap-In Filler Panels, page 1-9, in cabinets with square-punched mounting rails to seal any open rack-mount space (U) once all equipment is installed.*

*Use Full Height PDU Bracket, page 1-12, to support PDUs in the cabinet.*

Inside Dimensions, Usable Internal Cable Area			
Cabinet Width	Width in (mm)	Depth in (mm)	Cable in <sup>2</sup> (mm <sup>2</sup> )
31.5 (800)	2.3 (58)	5.5 (140)	12.6 (8130)
40.0 (1016)	4.2 (107)	3.5 (89)	14.7 (9480)



## Telescoping Cable Manager

Telescoping Cable Manager attaches to the sides of the front and rear equipment mounting rail providing a front-to-rear or vertical pathway for cables.

- Attaches to and adjusts in depth with mounting rails, fully compatible with Front Air Dams and Side Intake Duct
- Five smooth, plastic L-shaped spools support cables
- Spools on 31.5"W (800 mm) model are 2.5"H x 2.6"D (64 mm x 66 mm)
- Spools on 40.0"W (1016 mm) model are 3.3"H x 6.8"D (84 mm x 173 mm)
- Spools rotate and lock in 90-degree increments and can be adjusted to manage horizontal or vertical cable runs
- Includes: cable manager, five cable spools, installation hardware
- Material: Steel manager, plastic spools. Finish: Black or Glacier White
- Select part number to match the color of the cabinet

Part Number – Cabinet Width		Frame Depth in (mm)	Shipping Weight lb (kg)
31.5"W (8 mm)	40.0"W (1016 mm)		
39377-X01	39377-X02	Any	5 (2.3)

*X=color, C=Black, E=Glacier White. Shipping Weights are for 1016 mm kits.*



## Cable Lashing Manager

Cable Lashing Manager creates a simple vertical pathway for multiple cable bundles and has multiple attachment points for securing cables using CPI Saf-T-Grip® Straps or zip ties. Use to support network cables along the sides of the cabinet.

- Attaches to the frame, adjusts in depth independent of the equipment mounting rails. Two sizes: Slim and Wide
- Slim manager is 5"W (130 mm) and has three vertical columns of attachment points for 1.5" (38 mm) diameter cable bundles, 5 in<sup>2</sup> (3200 mm<sup>2</sup>) cable fill area
- Wide manager is 9.8"W (250 mm) and has five vertical columns of attachment points for 1.5" (38 mm) diameter cable bundles, 9.8 in<sup>2</sup> (6320 mm<sup>2</sup>) cable fill area
- Includes: Bracket and installation hardware, order Saf-T-Grips or cable ties separately
- Material: Steel
- Select part number to match usable height and color of the cabinet

Part Number		Height (U)	Shipping Weight lb (kg)
Slim	Wide		
5.1"W (130 mm)	9.8"W (250 mm)		
39380-X00	39381-X00	42	19 (8.9)
39380-X01	39381-X01	43	20 (9.1)
39380-X02	39381-X02	44	20 (9.1)
39380-X03	39381-X03	45	21 (9.5)
39380-X04	39381-X04	46	21 (9.5)
39380-X05	39381-X05	47	21 (9.5)
39380-X06	39381-X06	48	22 (10.0)
39380-X07	39381-X07	49	22 (10.0)
39380-X08	39381-X08	50	23 (10.4)
39380-X09	39381-X09	51	23 (10.4)
39380-X10	39381-X10	52	24 (10.9)

X=color; C=Black, E=Glacier White. Shipping Weights for wide managers.



## Radius Drop

Radius Drop attaches to the top of the cabinet and provides a smooth curved support where cables exit or enter the cable management space along the sides of the cabinet.

- Attaches to the top of the cabinet to support cables as they exit/enter the cabinet
- Radius drop is 11"L (279 mm) with a 1.3" (33 mm) diameter radius
- Includes: radius drop, installation hardware. Material: Aluminum
- Select part number to match the color of the cabinet

Part Number Cabinet Width		Frame Depth in (mm)	Shipping Weight lb (kg)
31.5"W (8 mm)	40.0"W (1016 mm)		
39327-X01	39327-X01	Any	1 (0.5)

X=color; C=Black, E=Glacier White.

# GF-SERIES GLOBALFRAME® GEN 2 CABINET SYSTEM



## GF-Series GlobalFrame® Gen 2 Cabinet System

The GF-Series GlobalFrame® Gen 2 Cabinet System is an industry-standard server and network equipment storage solution for data centers, computer rooms or network facilities.

Available in a select set of industry-standard sizes, GF-Series GlobalFrame features two specific configurations that meet most application requirements. Standard cabinets with perforated front and rear doors support front-to-rear airflow for hot aisle/cold aisle or aisle containment applications. High-density cabinets with perforated front and solid rear doors and a top-mount Vertical Exhaust Duct guide hot exhaust air away from the cabinet to support a closed return application. Both configurations cover the basics with adjustable depth Z-shaped mounting rails that help block bypass airflow around equipment. Cable openings in the top panels are large enough for high-amperage PDU power plugs, casters easily position the cabinet and locking doors and side panels secure equipment.

Additionally, CPI's second generation GF-Series GlobalFrame features new size and finish options, enhanced panels and doors, and smarter airflow management. The frame is now available in a standard 52U height, 700 mm width and 1100 mm depth to maximize space utilization, and a Glacier White finish that reflects more light. Maximum front-to-rear rail depths are increased to support deeper equipment. Top and bottom panels include snap-on plastic grommets to seal cable openings. Perforated areas on the doors are 78% open to maximize airflow, and the improved Air Dam accessory (ordered separately), which creates an airflow barrier around the rails to block bypass air inside the cabinet, allows rails to be adjusted to any depth.

Combine the GF-Series GlobalFrame with thermal and cable management accessories to create a solution that fits your exact needs.

### Cabinet Specifications:

- Available in four heights, four widths and five depths
- Provides front and rear support for 19"W (482.6 mm) EIA rack-mount equipment and shelves
- Adjustable depth, rails slide front-to-back
- Marks on frame for easy vertical alignment
- 1-3/4"H (44.45 mm) U spacing, marked and numbered
- 19"W, EIA-310-E Universal vertical hole spacing
- Load capacity for 6-slide frame (per UL2416):
  - 3000 lb (1360 kg), static load on leveling feet
  - 2250 lb (1020 kg), rolling load on casters
  - 2000 lb (907.2 kg), shipping on shock pallet
- Load capacity for 4-slide frame (per UL2416):
  - 2500 lb (1134 kg), static load on leveling feet
  - 2000 lb (907.2 kg), rolling load on casters

### Cabinet Includes:

- Welded steel and bolted aluminum four-post frame
- Equipment mounting rails, two pairs
- Grounding/bonding system and ground lug
- Leveling feet and casters
- Floor attachment brackets
- Baying kit, for 600 mm or 24" spacing
- PDU brackets, one pair, for two 2.2"W (56 mm) vertical CPI PDUs
- Equipment mounting hardware, (50) M6 cage nuts and screws

### Certifications:

- EIA-310-E compliant
- UL Listed 2416, NWIN, File #E227626

# GF-SERIES GLOBALFRAME® GEN 2 CABINET SYSTEM

Use the part number configurator below to select a GF-Series GlobalFrame Cabinet. Choose the **Height**, **Width**, **Depth**, **Side Panel Style**, **Configuration**, **Color**, and **Frame Style**. **Example Cabinet Part Number: GF-1A100-CB**.

## Industry Standard Model Matrix:

All selections from this table offer the most affordable pricing and shortest lead times.

GF	-	H	W	D	S	C	-	C	F
----	---	---	---	---	---	---	---	---	---

### 600 mm, 700 mm, 800mm Standard Cabinets

GF-	1. Height			2. Width			3. Depth		4. Side Panels	5. Configuration	-	6. Color	7. Frame			
	U	in	mm	in	mm	in	mm	Description	Description	Description		Description				
1	42	79.4	2016	A	23.6	600	1	31.5	800	0	No Sides	Standard Top Panel/Standard Pallet	C	Black	B	6-Slide
2	45	84.6	2149	D	27.6	700	2	39.4	1000	1	One Side		E	Glacier		
3	48	89.9	2282	C	31.5	800	5	43.3	1100	2	Two Sides					
4	52	96.9	2460				4	47.2	1200							

Notes:

Height includes casters.

Frame depth does not include doors. Doors add approximately 4" (100 mm). See page 1-29 for detailed dimensions.

Includes Perforated Front and Rear Doors.

### 600 mm, 700 mm, 800mm Vertical Exhaust Duct Cabinets

GF-	1. Height			2. Width			3. Depth		4. Side	5. Configuration	-	6. Color	7. Frame			
	U	in	mm	in	mm	in	mm	Description	Description	Description		Description				
1	42	79.4	2016	A	23.6	600	5	43.3	1100	0	No Sides	Duct 20-34" H (508-863 mm)/ Standard	C	Black	B	6-Slide
2	45	84.6	2149	D	27.6	700	4	47.2	1200	1	One Side		E	Glacier		
3	48	89.9	2282	C	31.5	800				2	Two Sides					
4	52	96.9	2460													
										1		Duct 34-60" H (863-1523 mm)/ Standard				
										2						

Notes:

Height includes casters. Height does not include Vertical Exhaust Duct.

Frame depth does not include doors. Doors add approximately 4" (100 mm). See page 1-29 for detailed dimensions.

Includes Perforated Front Door.

Solid Rear Door, Vertical Exhaust Duct and Bottom Panel.

### 600 mm, 700 mm Shock Pallet Combinations

GF-	1. Height			2. Width			3. Depth		4. Side Panels	5. Configuration	-	6. Color	7. Frame			
	U	in	mm	in	mm	in	mm	Description	Description	Description		Description				
1	42	79.4	2016	A	23.6	600	5	43.3	1100	0	No Sides	Standard Top Panel/Shock Pallet	C	Black	B	6-Slide
2	45	84.6	2149	D	27.6	700	4	47.2	1200	1	One Side		E	Glacier White		
				C	31.5	800				2	Two Sides					

Notes:

Height includes casters.

Frame depth does not include doors. Doors add approximately 4" (100 mm). See page 1-29 for detailed dimensions.

Includes Perforated Front and Rear Doors.

Reusable Packaging.

# GF-SERIES GLOBALFRAME® GEN 2 CABINET SYSTEM

Use the part number configurator below to select a GF-Series GlobalFrame Cabinet. Choose the **Height**, **Width**, **Depth**, **Side Panel Style**, **Configuration**, **Color**, and **Frame Style**. **Example Cabinet Part Number: GF-1A100-CB.**

## Complete Product Matrix:

The complete product matrix includes all options available.

GF	-	H	W	D	S	C	-	C	F
----	---	---	---	---	---	---	---	---	---

### 600 mm, 700 mm, 800mm Standard Cabinets

GF-	1. Height			2. Width			3. Depth			4. Side		5. Configuration		6. Color		7. Frame	
	U	in	mm	A	in	mm	1	in	mm	Description	Description	Description	Description				
1	42	79.4	2016	A	23.6	600	1	31.5	800	0	No Sides	0	Standard Top Panel/Standard Pallet	C	Black	B	6-Slide
2	45	84.6	2149	D	27.6	700	2	39.4	1000	1	One Side			E	Glacier	A	4-Slide
3	48	89.9	2282	C	31.5	800	3	41.3	1050	2	Two Sides						
4	52	96.9	2460				5	43.3	1100								
							4	47.2	1200								

Notes: Height includes casters.

Frame depth does not include doors. Doors add approximately 4" (100 mm). See page 1-29 for detailed dimensions.

Includes Perforated Front and Rear Doors.

### 600 mm, 700 mm, 800mm Vertical Exhaust Duct Cabinets

GF-	1. Height			2. Width			3. Depth			4. Side Panels		5. Configuration		6. Color		7. Frame	
	U	in	mm	A	in	mm	3	in	mm	Description	Description	Description	Description				
1	42	79.4	2016	A	23.6	600	3	41.3	1050	0	No Sides	1	Duct 20-34" H (508-863 mm)/ Standard	C	Black	B	6-Slide
2	45	84.6	2149	D	27.6	700	5	43.3	1100	1	One Side			E	Glacier	A	4-Slide
3	48	89.9	2282	C	31.5	800	4	47.2	1200	2	Two Sides						
4	52	96.9	2460									2	Duct 34-60" H (863-1523 mm)/ Standard				

Notes: Height includes casters. Height does not include Vertical Exhaust Duct. Frame depth does not include doors. Doors add approximately 4" (100 mm). See page 1-29 for detailed dimensions. Includes Perforated Front Door, Solid Rear Door, Vertical Exhaust Duct and Bottom Panel.

Includes Perforated Front Door, Solid Rear Door, Vertical Exhaust Duct and Bottom Panel.

### 750 mm Standard and Vertical Exhaust Duct Cabinets

GF-	1. Height			2. Width			3. Depth			4. Side		5. Configuration		6. Color		7. Frame	
	U	in	mm	B	in	mm	3	in	mm	Description	Description	Description	Description				
1	42	79.4	2016	B	29.5	750	3	41.3	1050	0	No Sides	0	Standard Top Panel/Standard Pallet	C	Black	B	6-Slide
2	45	84.6	2149				5	43.3	1100	1	One Side			E	Glacier		
3	48	89.9	2282				4	47.2	1200	2	Two Sides						
												1	Duct 20-34" H (508-863 mm)/ Standard				
												2	Duct 34-60" H (863-1523 mm)/ Standard				

Notes: Height includes casters. Height does not include Vertical Exhaust Duct. Frame depth does not include doors. Doors add approximately 4" (100 mm). See page 1-29 for detailed dimensions.

Includes Perforated Front Door, Solid Rear Door, Vertical Exhaust Duct and Bottom Panel.

### 600 mm, 700 mm, 750 mm & 800 mm Shock Pallet Combinations

GF-	1. Height			2. Width			3. Depth			4. Side		5. Configuration		6. Color		7. Frame	
	U	in	mm	A	in	mm	3	in	mm	Description	Description	Description	Description				
1	42	79.4	2016	A	23.6	600	3	41.3	1050	0	No Sides	3	Standard Top Panel/Shock Pallet	C	Black	B	6-Slide
2	45	84.6	2149	D	27.6	700	5	43.3	1100	1	One Side			E	Glacier		
				B	29.5	750	4	47.2	1200	2	Two Sides						
				C	31.5	800											

Notes: Height includes casters. Frame depth does not include doors. Doors add approximately 4" (100 mm). See page 1-29 for detailed dimensions. Includes Perforated Front and Rear Doors. Reusable Packaging.

## Specifications/Ordering Notes:

1. Height, Widths, Depths: See tables below for detailed dimensions.

Height Dimensions - in (mm)			
Rack Mount Spaces (U)	Overall with Casters	Frame Only No Casters	Front Opening
42	79.4 (2016)	77.4 (1965)	73.9 (1876)
45	84.6 (2149)	82.6 (2099)	79.1 (2010)
48	89.9 (2282)	87.9 (2232)	84.4 (2143)
52	96.9 (2460)	94.9 (2410)	91.4 (2321)

*Casters add approximately 2" (51 mm) to frame and are factory installed on the cabinet.*

Depth Dimensions - in (mm)			
Nominal Depth	Overall with Doors	Frame Only No Doors	Maximum Rail Depth
800	35.4 (900)	31.5 (800)	29.3 (745)
1000	43.3 (1100)	39.4 (1000)	37.2 (945)
1050	45.3 (1150)	41.3 (1050)	39.2 (995)
1100	47.3 (1200)	43.3 (1100)	41.1 (1045)
1200	51.2 (1300)	47.2 (1200)	45.1 (1145)

*Front Door is approximately 2.4"D (61 mm), and Rear Door is approximately 1.5"D (38 mm) with hinges/latches. Minimum rail depth is 7" (178 mm), each rail is 3.5"D (89 mm). Rail depth is reduced when vertical accessories are placed in corners.*

Width Dimensions - in (mm)			
Nominal Width	Overall with Side Panels	Front Opening	Rack-Mount Panel Width
600	23.6 (600)	19.6 (498)	19 (482.6)
700	27.6 (700)	23.5 (598)	19 (482.6)
750	29.5 (750)	25.5 (648)	19 (482.6)
800	31.5 (800)	27.5 (698)	19 (482.6)

*Mounting Rail clearance is 17.8" (452 mm). Mounting hole spacing is 18.3" (465 mm).*

- Standard Cabinets include a cabinet with perforated front and rear doors, a solid top panel, casters and leveling feet. They ship on a standard pallet.
- Vertical Exhaust Duct Cabinets include a cabinet with perforated front and solid rear doors, a Vertical Exhaust Duct top panel, casters and leveling feet. They ship on a standard pallet. The Vertical Exhaust Duct ships uninstalled, partially assembled and boxed separately.
- Shock Pallet Combinations include a cabinet with perforated front and rear doors, a solid top panel, casters and leveling feet. They ship on a shock pallet with reusable packaging. The cabinet can be loaded with up to 2000 lb (907.2 kg) of equipment and then reshipped to a customer site.



Log on to the CPI Product Configurator [www.chatsworth.com/configurator](http://www.chatsworth.com/configurator) to create a design that omits front doors or top panels or to see all options available and to create a part number. For additional assistance, contact Technical Support at 800-834-4969.



## Air Dam Kit

Use to block airflow around the top and sides of equipment. Requires a minimum rail setback of 1.3" (33 mm) from the front of the cabinet frame.

- Use with Equipment Rail Grommet Kit, Snap-In Filler Panels and Bottom Panel. Attaches to and adjusts with mounting rails

Part Number - Cabinet Width For 6-Slide Frame Style				Height (U)	Shipping Weight lb (kg)
23.6"W (600 mm)	27.6"W (700 mm)	29.5"W (750 mm)	31.5"W (800 mm)		
39085-X00	39085-X11	39085-X33	39085-X22	42	11 (5.0)
39085-X03	39085-X14	39085-X36	39085-X25	45	11 (5.0)
39085-X06	39085-X17	39085-X39	39085-X28	48	12 (5.4)
39085-X10	39085-X21	N/A	39085-X32	52	13 (5.9)
Part Number - Cabinet Width For 4-Slide Frame Style				Height (U)	Shipping Weight lb (kg)
23.6"W (600 mm)	27.6"W (700 mm)	29.5"W (750 mm)	31.5"W (800 mm)		
39130-X00	39130-X11	N/A	39130-X22	42	11 (5.0)
39130-X03	39130-X14	N/A	39130-X25	45	12 (5.4)
39130-X06	39130-X17	N/A	39130-X28	48	12 (5.4)
39130-X10	39130-X21	N/A	39130-X32	52	13 (5.9)

X=Color, C=Black, E=Glacier White. Shipping Weights are 800 mm kits.



## Equipment Rail Grommet Kit

Set of plastic grommets that cover cable openings in the equipment mounting rails in the wider cabinets to block airflow around equipment.

Part Number	Description H x W (in)	Shipping Weight lb (kg)
39133-001	Equipment Rail Grommet Kit, Pack of 8	2 (0.9)

Note: Use with 27.6"W (700 mm), 29.5"W (750 mm) or 31.5"W (800 mm) rails.



## Snap-In Filler Panel

Snap-In Filler Panel blocks airflow in between equipment by sealing unused rack-mount spaces (U) in the cabinet. Use with Air Dam Kit, Equipment Rail Grommet Kit and Bottom Panel to separate cold and hot air within the cabinet.

Part Number			Height (U)	Shipping Weight lb (kg)
Each (1)	Each (6)	Each (50)		
34537-X00	34537-X01	34537-X02	1U	14 (6.4)
34538-X00	34538-X01	34538-X02	2U	21 (9.5)

X=Color, 0=Black, E=Glacier White. Shipping Weights are for 50 pack.



## Bottom Panel

Bottom Panel with grommet sealed cable openings blocks airflow under the cabinet, so hot air is contained in the rear of the cabinet when the cabinet frame is elevated on leveling feet or casters.

- Upgrade for Standard Cabinets; use with Air Dam
- Solid panel with two large grommet sealed cable opening in the back corners
- Grommets are plastic, snap-on, seal cable openings, and can be cut to pass cables
- Unsealed openings are 4.5"W x 9.0"D (114 mm x 228 mm), wide enough to pass large PDU plugs
- Attaches to the bottom slide on the cabinet; install before rack-mount equipment
- Two piece panel for easier installation, adjusts to fit cabinets 39.4" (1000 mm) or deeper
- Includes: bottom panel, grommets, installation brackets and hardware

Part Number Cabinet Width				Depth in (mm)	Shipping Weight lb (kg)
23.6"W (600 mm)	27.6"W (700 mm)	29.5"W (750 mm)	31.5"W (800 mm)		
39080-X00	39080-X01	39080-X03	39080-X02	≥39.4 (1000)	29 (13.2)

*X=Color, C=Black, E=Glacier White. Shipping Weights are for 800 mm kits.*



## Air Director

Air Director is an angled panel used at the back of cabinets with Vertical Exhaust Duct top panels to guide hot air towards the top of the cabinet.

- Universal, three piece design adjusts in width to fit all cabinets
- Attaches to the bottom slide on the cabinet, adjusts in depth
- Includes: director, installation hardware

Part Number	Description H xW (in)	Shipping Weight lb (kg)
39107-X00	Air Director	10 (4.5)

*X=Color, C=Black, E=Glacier White.*



## Cable Port Brush Kit

Cable Port Brush Kit is a pair of snap-on brush covers that can be used to replace the plastic grommets included with the top, bottom and side panels to form a better seal for cable openings.

- Easy addition and removal of cables through brush opening
- Brushes form a tight seal around cables to minimize air leakage
- Split, two-piece, snap-on design for easy installation around cable bundles

Part Number	Description H xW (in)	Shipping Weight lb (kg)
25190-001	Brush Covers, Pack of 2, Black	2 (0.9)





## Side Panel with Grommet Seal Openings

Side Panel with Grommet Seal Cable Openings features multiple grommet-sealed cable openings that allow cables to enter the side of the cabinet, while containing exhaust air within each cabinet.

- Two-piece design with top and bottom halves for easier handling
- Eight cable openings per side, four per half-height panel, one per corner, are 4.5"W x 9"D(114 mm x 228 mm) without grommet, sized for large power plugs
- Grommets are plastic, snap-on, seal cable opening and can be cut to pass cables
- Tool-less removal, drop in design with integrated locking spring latch secures the side panel to the cabinet frame
- Integrated grounding tabs to electrically bond the side panel to cabinet frame
- Includes: Side panel (two halves, with grommets), installation hardware, set of keys

Part Number						Cabinet Frame Depth in (mm)	Shipping Weight lb (kg)
Frame Style		Height (U)					
6-Slide	4-Slide	42	45	48	52		
39037	39033	-X00	-X51	-XAC	-XDL	31.5 (800)	44 (20.0)
		-X08	-X59	-XAL		39.4 (1000)	56 (25.4)
		-X10	-X61	-XAN	-XEA	41.3 (1050)	59 (26.8)
		-X12	-X63	-XAR	-XEC	43.3 (1100)	62 (28.1)
		-X16	-X67		-XEG	47.2 (1200)	68 (30.8)

X=color: C=Black, E=Glacier White. Shipping Weights are for 4-Slide, 52U panels. 6-Slide panels are approximately 8 lb (3.6 kg) lighter.



## Bay Seal Kit

Bay Seal Kit is only used with 23.6"W (600 mm) cabinets when the cabinets are bayed to align with 24"W (610 mm) floor tiles. The bay seal kit fills the small gaps left between cabinets.

- Flexible plastic insert that blocks airflow between cabinets
- Includes: side baffles, cut to length
- Material: Plastic; Finish: Black only
- Select part number to match the usable height of the cabinet

Part Number	Height (U)	Shipping Weight lb (kg)
39137-700	42	5 (2.3)
39137-703	45	5 (2.3)
39137-706	48	5 (2.3)
39137-710	52	5 (2.3)

Note: All heights (U) available.

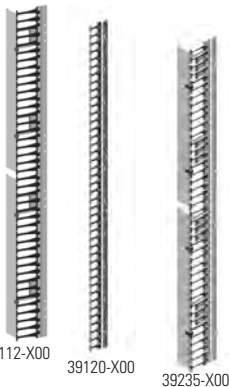

## Finger Cable Manager

Finger Cable Manager attaches to the equipment mounting rail, creating a pathway for cables next to the rail and includes plastic T-shaped cable guides (fingers) that organize cables by rack-mount space (U).

- Attaches to and adjusts with mounting rails, fully compatible with Air Dam
- Plastic, T-shaped cable guides organize cables by rack-mount space (U)
- Openings between cable guides (fingers) align with each rack-mount space on the mounting rail
- Pass up to 48 cables per U space through openings on the Finger Cable Manager. Pass up to 24 cables per U space through openings on the Finger Cable Manager, Short.
- Hinged cover included with managers in wider cabinets, cover snaps closed to secure cables
- Includes: finger cable manager, cover (wider cabinets only), installation hardware. Material: Steel panels, plastic guides and latches
- Select part number to match the width, usable height and color of the cabinet

Inside Dimensions, Usable Internal Cable Area, Rails Setback				
Cabinet Width	Width in (mm)	Depth in (mm)	Cable Area in <sup>2</sup> (mm <sup>2</sup> )	Rail Setback in (mm)
<b>Finger Cable Manager</b>				
27.6 (700)	2.6 (66)	8.4 (213)	21.8 (14 060)	10.1 (257)
39.5 (750)	3.7 (94)	8.4 (213)	31.0 (20 000)	10.1 (257)
31.5 (800)	4.6 (117)	8.4 (213)	38.6 (24 900)	10.1 (257)
<b>Finger Cable Manager, Short</b>				
23.6 (600)	.5 (13)	6.0 (150)	3 (1900)	7.6 (193)
27.6 (700)	2.6 (66)	6.0 (150)	15.6 (10 060)	7.6 (193)
29.5 (750)	3.7 (94)	6.0 (150)	21.6 (13 940)	7.6 (193)
31.5 (800)	4.6 (117)	6.0 (150)	27.8 (17 940)	7.6 (193)

Rail setback is the minimum distance required between the front edge of the cabinet frame and the front edge of the equipment mounting rail.



Part Number – Cabinet Width				Height in (mm)	Shipping Weight lb (kg)
23.6" W (600 mm)	27.6" W (700 mm)	29.5" W (750 mm)	31.5" W (800 mm)		
<b>Finger Cable Manager</b>					
N/A	39112-X11	39112-X33	39112-X22	42	22 (10.0)
N/A	39112-X14	39112-X36	39112-X25	45	23 (10.4)
N/A	39112-X17	39112-X39	39112-X28	48	25 (11.3)
N/A	39112-X21	N/A	39112-X32	52	26 (11.8)
<b>Finger Cable Manager, Short</b>					
39120-X00	39235-X11	39235-X33	39235-X22	42	21 (9.5)
39120-X03	39235-X14	39235-X36	39235-X25	45	22 (10.0)
39120-X06	39235-X17	39235-X39	39235-X28	48	23 (10.4)
39120-X10	39235-X21	N/A	39235-X32	52	24 (10.9)

X=color: C=Black, E=Glacier White. Shipping Weights are for 800 mm kits.

## Front-to-Rear Cable Manager

Front-to-Rear Cable Manager attaches to the back of equipment mounting rails creating a front-to-rear pathway between the front and rear mounting rails for cables.

- For use on 27.6" W (700 mm), 29.5" (750 mm) and 31.5" W (800 mm) cabinets
- Mounting locations behind cable openings on each rail
- Attaches to mounting rails and extends to match depth
- Creates a 2.5" W (64 mm) x 3" D (78 mm) front-to-rear pathway for cables

Part Number – Cabinet Width		Rail Depth Range in (mm)	Shipping Weight lb (kg)
23.6" W (600 mm)	27.6" W (700 mm), 29.5" W (750 mm), 31.5" W (800 mm)		
N/A	39077-X00	22-34 (558-863)	5 (2.3)

X=color: C=Black, E=Glacier White.



## Full Height PDU Bracket

Full Height PDU Bracket supports two vertical PDUs side-by-side and has multiple slots for CPI Saf-T-Grip® Straps or tie wraps to secure cords to the bracket.

- Attaches to the frame, adjusts in depth independent of the mounting rails
- Available in two widths: Dual and Wide
- Dual bracket is 4.8"W (121 mm) and supports two PDUs up to 2.2"W (51 mm) side-by-side
- Dual bracket supports most CPI eConnect PDUs and power strips side-by-side
- Wide bracket is 5.8"W (147 mm) and supports two PDUs up to 2.7"W (69 mm) side-by-side
- Wide bracket is required to mount two 6-Breaker eConnect PDUs (series P/Nx PX-3XXXX), side-by-side
- Tool-less mounting on 28" (711 mm), 61.25" (1556 mm) or 64.75" (1645 mm) centers
- Includes: brackets, installation hardware, order Saf-T-Grips or cable ties separately

Part Number		Height (U)	Shipping Weight lb (kg)
Dual	Wide		
39086-X00	39221-X00	42	9 (4.1)
39086-X03	39221-X03	45	10 (4.5)
39086-X06	39221-X06	48	10 (4.5)
39086-X10	39221-X10	52	11 (5.0)

X=color: C=Black, E=Glacier White.



## Cable Lashing Bracket

Cable Lashing Bracket creates a simple, separate vertical pathway for a small bundle of cables and has multiple slots for CPI Saf-T-Grip® Straps or tie wraps to secure cables to the bracket.

- Attaches to the frame, adjusts in depth independent of the mounting rails
- Bracket is 1.6"W (41 mm); order Saf-T-Grips or cable ties separately

Part Number - Frame Style		Height (U)	Shipping Weight lb (kg)
6-Slide	4-Slide		
39124-X00	39131-X00	42	4 (1.8)
39124-X03	39131-X03	45	5 (2.3)
39124-X06	39131-X06	48	5 (2.3)
39124-X10	39131-X10	52	5 (2.3)

X=color: C=Black, E=Glacier White.



## Leveling Feet Height Adjustment Tool

- Used in drill/driver to adjust the height of leveling feet.
- 5 mm Hex Ball Driver Tool; 12"L (300 mm)

Part Number	Description	Shipping Weight lb (kg)
39150-001	Hex Ball Driver Tool	1 (0.5)



## Ring Cable Manager

Ring Cable Manager is independent of the equipment mounting rails, creating a separate vertical pathway for cables and includes plastic cable rings to organize cables.

- Attaches to the frame, adjusts in depth independent of the mounting rails
- Rings have an opening on the front for easy addition or removal of cables
- Includes: brackets, rings, installation hardware

Inside Dimensions, Usable Internal Cable Area, Rails Setback				
Cabinet Width	Width in (mm)	Depth in (mm)	Cable Area in <sup>2</sup> (mm <sup>2</sup> )	Rail Setback in (mm)
23.6 (600)	.9 (29)	3.3 (84)	2.9 (1870)	7.6 (193)
27.6 (700) 29.5 (750)	2.3 (58)	5.5 (140)	12.6 (8130)	8.2 (208)
31.5 (800)	4.2 (107)	3.5 (89)	14.7 (9480)	6.4 (163)

*Note: Rail Setback is the minimum distance required between the front edge of the cabinet frame and the front edge of the equipment mounting rail.*



Part Number - Cabinet Width For 6-Slide Frame Style			Height (U)	Shipping Weight lb (kg)
23.6"W (600 mm)	27.6"W (700 mm) 29.5"W (750 mm)	31.5"W (800 mm)		
39087-X00	39088-X00	39089-X00	42	13 (5.9)
39087-X03	39088-X03	39089-X03	45	14 (6.4)
39087-X06	39088-X06	39089-X06	48	14 (6.4)
39087-X10	39088-X10	39089-X10	52	15 (6.8)
Part Number - Cabinet Width For 4-Slide Frame Style			Height (U)	Shipping Weight lb (kg)
23.6"W (600 mm)	27.6"W (700 mm)	31.5"W (800 mm)		
39127-X00	39128-X00	39129-X00	42	14 (6.4)
39127-X03	39128-X03	39129-X03	45	14 (6.4)
39127-X06	39128-X06	39129-X06	48	15 (6.8)
39127-X10	39128-X10	39129-X10	52	15 (6.8)

*X=Color; C=Black; E=Glacier White. Shipping Weights are 800 mm kits.*

## Seal Kit

Cover unused holes in the frame for hinges and installation brackets to prevent bypass airflow.

- Pre-cut, plastic, color-matched, adhesive backed labels for easy attachment to the cabinet
- Tough, heat resistant material and adhesive for long life
- Each kit includes 12 sheets; each sheet includes 21 round labels and six rectangular labels
- Round labels are .75" (19 mm) diameter. Rectangular labels are 1.3" x 2.2" (34 mm x 55 mm).
- Material: Thermoplastic polycarbonate film
- Select to match the color of the cabinet

Part Number	Description	Shipping Weight lb (kg)
39076-X00	Seal Kit	1 (0.5)



### Ramp Kit for Shock Pallet Cabinets

Ramp Kit includes a pair of steel ramps used to roll a loaded cabinet off of a shock pallet.

- Durable, welded steel construction for repeated use
- 1" H (25 mm) sides control casters to prevent the cabinet from rolling off ramp
- Gradual, 5' L (1.5 m) incline for controlled exit
- Includes: one pair of steel, black finish ramps
- Order one Ramp Kit per site for Shock Pallet Cabinets

Part Number	Description	Shipping Weight lb (kg)
39207-701	Ramp Kit for Shock Pallet Cabinets, Black	26 (11.8)



### Label Holder Kit

Label Holder Kit includes 24, 1" H x 4" W (25 mm x 100 mm) label holders that can attach to the front or sides of cabinets and hold labels for identifying the cabinet.

- Plastic, L-shaped, adhesive backed label holder for easy attachment to the cabinet. Tough, heat resistant material and adhesive for long life.
- Each kit includes 24 label holders. 1" H x 4" W (25 mm x 100 mm) surface for labels; labels not included. Material: Rigid PVC plastic, UL94-V0.

Part Number	Description	Shipping Weight lb (kg)
39151-001	Label Holder, Pack of 24, Black	1 (0.5)



### Electronic Lock Kit

Electronic Lock Kit is a retrofit kit for the cabinet door that enhances security by eliminating the need for keys. Each lock can be programmed with multiple access codes, allowing assignment of administrator and user only rights.

- Standalone electronic keypad lock (not networked, no audit trail)
- Two options: System 1000 or System 1500
- Three user levels with programmable access codes:
  - Master code (8-digit) – full administrative rights
  - Sub-Master code (8-digit) – set/delete user code
  - User code (4-digit)
- System 1000 supports 3 access codes, approximately 15,000 openings with new batteries 2 x 1.5 VDC AAA batteries and has a silver-colored handle with black mounting plate
- System 1500 supports 22 access codes, approximately 50,000 openings with new 2 x 3 VDC CR2450 coin batteries, has an audible keypad, dual access code mode and black handle and mounting plate.

Part Number - By Door Style			Description	Shipping Weight lb (kg)
Front Door Single, Perf	Rear Door Single, Solid	Rear Door Double, Perf		
39224-C00	39223-C00	39225-C99	System 1000	3 (1.4)
39224-C01	39223-C01	39228-C99	System 1500	3 (1.4)

*Note: These are retrofit electronic lock kits that replace the swing handle on the cabinet door of a GF-Series GlobalFrame Gen 2 Cabinet.*



Load-Tested  
GR-63  
Zone 4

California  
OSHPD  
OPM-0112-13

## Z4-Series SeismicFrame® Cabinet System

The Z4-Series SeismicFrame® Cabinet System is an engineered solution specifically designed to store critical rack-mount server, data storage and network equipment in computer rooms, equipment rooms and other communications facilities that are located in active seismic areas.

Featuring an industry-leading 1500 lb (680 kg) equipment load, the Z4-Series SeismicFrame can also support an additional 100 lb (45 kg) top load for cabling. This cabinet was tested by a Telecommunications Carrier Group and ISO 17025 certified Independent Testing Laboratory (ITL) to meet the Telcordia Technologies GR-63-CORE, Issue 4, April 2012, Sections 4.4 per Zone 4 requirements. GR-63-CORE seismic testing includes a series of physical shaker table tests, during which a loaded cabinet is placed through simulated earthquake conditions. Zone 4 testing includes the most severe test conditions, in which the cabinet must perform with limited movement and survive the test without permanent structural or mechanical damage, ensuring the internal equipment is not damaged.

The cabinet is available with optional solid top panel, solid side panels and perforated doors. Top panel has four cable ports (one per corner). The side panels bolt on, and include locks. The front door is a single door with single point latch. The rear door is double (vertically split) with a three-point latch. Combine the Z4-Series SeismicFrame Cabinet with thermal and cable management accessories to create a solution that fits your exact needs.

### Cabinet Specifications:

- Available in 2 heights, 2 widths, 2 depths
- Provides front and rear support for 19"W (482.6 mm) EIA rack-mount equipment and shelves
- Adjustable depth, rails slide front-to-back
- Marks on frame for easy vertical alignment
- 1-3/4"H (44.45 mm) U spacing, marked and numbered
- 19"W, EIA-310-E Universal vertical hole spacing
- Seismic Load: 1500 lb (680 kg) internal seismic equipment load  
100 lb (45 kg) additional cabinet roof load
- Static Load: 3000 lb (1360 kg) per UL2416

### Cabinet Includes:

- Welded and bolted steel four-post frame
- Equipment mounting rails, two pairs
- Grounding/bonding system and ground lug
- Recessed leveling feet
- Removable transport casters
- Baying kit
- Equipment mounting hardware, (50) M6 cage nuts and screws

### Certifications:

- EIA-310-E compliant
- UL Listed 2416, NWIN, File #E227626
- TCG NEBS Compliant, Telcordia Technologies, GR-63-CORE, Issue 4, April 2012, Sections 4.4, per Zone 4 requirements
- OSHPD OPM-0112-13 California, Office of Statewide Health Planning and Development (OSHPD), Preapproval of Manufacturer's Certification (OPM)



OSHPD OPM-0112-13 provides pre-approved, code-compliant seismic designs of supports and attachments for the cabinet when used in health facilities in California.

# Z4-SERIES SEISMICFRAME® CABINET SYSTEM

Z4-Series SeismicFrame Cabinet is available in three basic configurations: a full cabinet with or without side panels, a cabinet with no doors with or without side panels or a frame only with no doors or panel work. Use the part number configurators below to select a Z4-Series SeismicFrame Cabinet. Choose Height, Width, Depth, Front Door, Locks and Sides based on your requirements.

**Example Cabinet Part Number: Z4-12U-113C-C12.**

## Z4-Series SeismicFrame Cabinets - Frame with Top Panels and Doors, Side Panels are optional.

Z4	-	H	W	D	-	R	FD	RD	L	-	C	TP	SP
<b>Height</b>				<b>Rails</b>				<b>Side Panels</b>					
<b>U</b>	<b>in</b>	<b>mm</b>		Square-Punched	<b>1</b>			<b>0</b>	None				
40	78.7	1999	<b>1</b>					<b>2</b>	Solid, 2 Each				
43	83.9	2132	<b>2</b>	<b>Front Doors</b>				<b>Top Panel</b>					
				None	<b>0</b>			<b>1</b>	Standard				
<b>Width</b>								<b>Color</b>					
<b>in</b>	<b>mm</b>							<b>C</b>	Black				
23.6	600	<b>1</b>		<b>Rear Doors</b>				<b>E</b>	Glacier White				
31.5	800	<b>2</b>		Double, Perforated	<b>3</b>								
<b>Depth</b>				<b>Latches</b>									
<b>in</b>	<b>mm</b>			2-Point, Keyed		<b>C</b>							
41.3	1050	<b>N</b>		2-Point, Keyed Combination		<b>E</b>							
47.3	1200	<b>U</b>											



Z4-12U-113C-C12 shown

## Z4-Series SeismicFrame Cabinets – Frame with Top Panel, no Doors, Side Panels are optional.

Z4	-	H	W	D	-	R	FD	RD	L	-	C	TP	SP
<b>Height</b>				<b>Rails</b>				<b>Side Panels</b>					
<b>U</b>	<b>in</b>	<b>mm</b>		Square-Punched	<b>1</b>			<b>0</b>	None				
40	78.7	1999	<b>1</b>					<b>2</b>	Solid, 2 Each				
43	83.9	2132	<b>2</b>	<b>Front Doors</b>				<b>Top Panel</b>					
				None	<b>0</b>			<b>1</b>	Standard				
<b>Width</b>				<b>Rear Door</b>				<b>Color</b>					
<b>in</b>	<b>mm</b>			None		<b>0</b>			<b>C</b>	Black			
23.6	600	<b>1</b>		<b>Latches</b>				<b>E</b>	Glacier White				
31.5	800	<b>2</b>		None		<b>0</b>							
<b>Depth</b>													
<b>in</b>	<b>mm</b>												
41.3	1050	<b>N</b>											
47.3	1200	<b>U</b>											



Z4-12U-1000-C10 shown

## Z4-Series SeismicFrame Cabinets – Frame Only, No Top Panel, No Doors, or Side Panels.

Z4	-	H	W	D	-	R	FD	RD	L	-	C	TP	SP
----	---	---	---	---	---	---	----	----	---	---	---	----	----

Height		
U	in	mm
40	78.7	1999
43	83.9	2132

Width		
in	mm	
23.6	600	1
31.5	800	2

Depth		
in	mm	
41.3	1050	N
47.3	1200	U

Rails	
Square-Punched	1

Front Doors	
None	0

Rear Door	
None	0

Latches	
None	0

Side Panels	
0	None

Top Panel	
0	None

Color	
C	Black
E	Glacier White



Z4-12U-1000-C00 shown

### Specification/Ordering Notes:

- There are eight possible frame sizes.
- Use the first matrix to order a complete cabinet with top, doors and sides; use the second matrix to order a cabinet with no doors; use the last matrix to order a Frame Only with no top, doors or sides.
- You must include a top panel when ordering a cabinet with doors.
- You can order a cabinet with or without side panels.
- You can order a cabinet with or without a front door.
- Choose latch/lock style: keyed or combination/keyed. Every door must have a latch. The (0) option should only be selected if there are no doors. Doors have a swing handle on the exterior. The combination lock uses a 3-digit combination entered on 3-dials that are integrated into the swing handle or a key. The combination lock can be reprogrammed in the field.
- The front door has a single-point latch; the rear door has a two-point latch.
- Heights, Widths, Depths: see tables below for detailed dimensions.

Height Dimensions - in (mm)			
Rack Mount Spaces (U)	Overall with Casters	Frame Only No Casters	Front Opening
40	78.7 (1999)	77.4 (1965)	70.4 (1789)
43	83.9 (2132)	82.6 (2099)	75.7 (1922)

Casters are factory-installed on the cabinet, used to move the cabinet into position and then removed before installation. The cabinet frame attaches directly to the floor.

Width Dimensions - in (mm)			
Nominal Width	Overall with Side Panels	Front Opening	Rack-Mount Panel Width
600	23.6 (600)	19.6 (498)	19 (482.6)
800	31.5 (800)	27.5 (698)	19 (482.6)

Mounting Rail clearance is 17.8" (452 mm), mounting hole spacing is 18.3" (465 mm).

Depth Dimensions - in (mm)			
Nominal Depth	Overall with Doors	Frame Only No Doors	Maximum Rail Depth
1050	45.1 (1146)	41.3 (1050)	35.8 (911)
1200	51.1 (1296)	47.2 (1200)	41.7 (1061)

Front Door is approximately 2.2"D (56 mm), and Rear Door is approximately 1.7"D (43 mm) with hinges/latches. Minimum rail depth is 10.2" (258 mm). The front rail is 6.7" (170 mm) deep; the rear rail is 3.5" (89 mm) deep. Rail Depth is reduced when vertical accessories are placed in corners.





## Air Dam Kit

Air Dam blocks airflow around the sides and top of the equipment mounting space, so cold air passes through equipment, and hot air does not recirculate around equipment.

- Use with Snap-In Filler Panels and Equipment Rail Grommet Kit
- Attaches to and adjusts with mounting rails
- Requires a minimum rail setback of 2.3" (58 mm) from the front of the frame
- Flexible seal against top and side panels
- Includes: top, bottom and side baffles; installation hardware
- Material: Steel baffles, plastic seals
- Select part number to match the width, usable height and color of the cabinet

Part Number		Height (U)	Shipping Weight lb (kg)
23.6"W (600 mm)	31.5"W (800 mm)		
14435-X00	14435-X02	40	14 (6.4)
14435-X01	14435-X03	43	15 (6.8)

*X=Color; C=Black; E=Glacier White. Shipping Weights are for 800 mm kits.*



## Equipment Rail Grommet Kit

Set of plastic grommets that cover cable openings in the equipment mounting rails in the wider cabinets to block airflow around equipment.

Part Number	Description H x W (in)	Shipping Weight lb (kg)
39133-001	Equipment Rail Grommet Kit, Pack of 8	2 (0.9)

*Note: Color is black. Use with 31.5"W (800 mm) rails.*



## Snap-In Filler Panel

Snap-In Filler Panels block airflow in-between equipment by sealing unused rack-mount spaces (U) in the cabinet. Use with Air Dam to separate cold and hot air within the cabinet.

- Finish: Black or Glacier White
- Available in 1U and 2U heights, individual or bulk packs, color-matched to cabinet

Part Number			Height (U)	Shipping Weight lb (kg)
Each (1)	Pack (6)	Pack (50)		
34537-X00	34537-X01	34537-X02	1U	14 (6.4)
34538-X00	34538-X01	34538-X02	2U	21 (9.5)

*X=Color; D=Black; E=Glacier White. Shipping Weights are for 50 pack.*

## Front-To-Rear Cable Manager

Front-to-Rear Cable Manager attaches to the back of equipment mounting rails, creating a front-to-rear pathway between the front and rear mounting rails for cables.

- For use on 31.5"W (800 mm) cabinets
- Mounting locations behind cable openings on each rail
- Attaches to mounting rails and extends from 17.5" (445 mm) to 30.5" (775 mm) to match rail depth
- Creates a 3.0"H (76 mm) by 2.5"W (64 mm) front-to-rear pathway for cables
- Includes: cable manager, installation hardware
- Material: Steel panels
- Select part number to match the color of the cabinet



Part Number		Rail Depth Range in (mm)	Shipping Weight lb (kg)
23.6"W (600 mm)	31.5"W (800 mm)		
N/A	14485-X00	17.5 - 30.5 (445 - 775)	6 (2.7)

*X=Color, C=Black, E=Glacier White.*

## Ring Cable Manager

Ring Cable Manager is independent of the equipment mounting rails, creating a separate vertical pathway for cables and includes plastic cable rings to organize cables.

- Attaches to the frame in a fixed location, independent of the equipment mounting rails
- Rings have an opening on the front for easy addition or removal of cables
- Includes: brackets, rings, installation hardware
- Material: Steel brackets, plastic rings
- Select part number to match the width, usable height and color of the cabinet



Part Number		Height (U)	Shipping Weight lb (kg)
23.6"W (600 mm)	31.5"W (800 mm)		
14440-X00	14445-X00	40	13 (5.9)
14440-X01	14445-X01	43	13 (5.9)

*X=Color, C=Black, E=Glacier White. Shipping Weights are for 800 mm managers.*

### Inside Dimensions, Usable Internal Cable Area, Rails Setback

Cabin Width	Width in (mm)	Depth in (mm)	Cable Area in <sup>2</sup> (mm <sup>2</sup> )	Rail Setback in (mm)
23.6 (600)	.9 (29)	3.3 (84)	2.9 (1870)	9.5 (240)
31.5 (800)	4.2 (107)	3.5 (89)	14.7 (9480)	9.7 (246)

*Note: Rail setback is the minimum distance required between the front edge of the cabinet frame and the front edge of the equipment mounting rail.*



## Cable Lashing Bracket

Cable Lashing Bracket creates a simple, separate vertical pathway for a small bundle of cables and has multiple slots for CPI Saf-T-Grip® Straps or tie wraps to secure cables to the bracket.

- Attaches to the frame in a fixed location, independent of the equipment mounting rails
- Use multiple to increase capacity
- Bracket is 1.6"W (41 mm)
- Includes: brackets, installation hardware; order Saf-T-Grips or cable ties separately
- Material: Steel
- Select part number to match the usable height and color of the cabinet

Part Number	Height (U)	Shipping Weight lb (kg)
14465-X00	40	3 (1.4)
14465-X01	43	3 (1.4)

*X=color; C=Black, E=Glacier White.*



## Full Height Dual PDU Bracket

Full Height Dual PDU Bracket supports two vertical PDUs side-by-side and has multiple slots for CPI Saf-T-Grip® Straps or tie wraps to secure cords to the bracket.

- Attaches to the frame in a fixed location, independent of the equipment mounting rails
- Available in two widths: Dual and Wide
- Dual bracket is 4.8"W (121 mm) and supports two PDUs up to 2.2"W (51 mm) side-by-side
- Wide bracket is 5.8"W (147 mm) and supports two PDUs up to 2.7"W (69 mm) side-by-side
- Wide bracket is required to mount two 6-breaker eConnect PDUs (series P/Ns PX-3XXXX) side-by-side; eConnect PDUs (series P/Ns PX-3XXXX) will only fit in the 43U cabinet.
- Tool-less mounting on 28" (711 mm), 61.25" (1556 mm) or 64.75" (1645 mm) centers
- Includes: brackets, installation hardware; order Saf-T-Grips or cable ties separately
- Material: Steel
- Select part number to match PDU size, usable height and color of the cabinet

Part Number		Height (U)	Shipping Weight lb (kg)
Dual	Wide		
14480-X00	14481-X00	40	12 (5.4)
14480-X01	14481-X01	43	11 (5.0)

*X=color; C=Black, E=Glacier White. Shipping weights are for Wide managers. eConnect PDUs (P/Ns PX-3XXXX) will not fit inside a 40U cabinet.*

# The M-Series MegaFrame® Cabinet

Attach 12" (300 mm) cable runway easily with pre-drilled attachment holes

Quick and easy assembly with unique patented corner attachment bracket

Adjustable (front to rear) vertical mounting rails allow use as a standard four-post cabinet or two channel rack

Rack-mount units marks simplify installation

Extruded horizontal mounting rail provides support for equipment mounting rails and cabling ring panels

Wide variety of mounting rails with Universal EIA 5/8"-5/8"-1/2" (15.9 mm -15.9 mm - 12.7 mm) alternating hole pattern to meet all equipment installation requirements

Adjustable leveling feet provide stability

Open base allows cable entry, exit and ventilation

Lightweight aluminum construction provides strength, durability, easy handling and lower shipping costs

Top Panel with 6 edge-protected punch-out ports provides cabling access wherever needed

Optional fan kit provides 400 CFM of airflow through cabinet

Fully adjustable side-mounted cabling ring sections provide unsurpassed vertical cable management without protruding into usable space

Inch markers on horizontal mounting rails ensure proper alignment of vertical mounting rails

Standard door options include smoked plexiglass or vented front door and solid aluminum rear door; options include vented plexiglass and perforated metal doors

"Quick release" attachment for front and rear doors provides easy assembly and equipment installation; door can be positioned to open to the right or left side

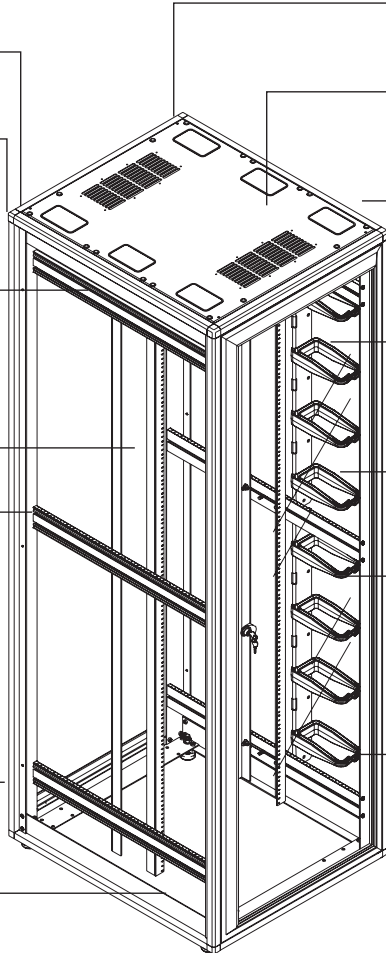

Available in up to 39" (990 mm) usable depth, many heights

Static load rating of 2000 lb (907.2 kg)

Solid aluminum side panels are easy-to-remove and locking

19" or 23" Standard EIA rack width



## M-Series MegaFrame® Cabinet 72", 78" and 84" (1830 mm, 1980 mm and 2130 mm)

The M-Series MegaFrame® Cabinet System supports a vast array of potential applications. The cabinet is available in a variety of heights, widths and depths to meet the most stringent demands. The M-Series Cabinet System also allows the user to select mounting rails to accommodate today's variety of rack-mount equipment.

### Cabinet Specifications:

- Available in three heights; 72", 78" and 84" (1830 mm, 1980 mm and 2130 mm)\*
- Available in 19" or 23" EIA standard rack widths
- Available in four depths; 24", 30", 36" and 39" (610 mm, 760 mm, 910 mm and 990 mm)
- Available with or without top or side panels
- Side panels are easy-to-remove and locking
- Can be ordered with or without doors in a variety of materials and styles
- Cabinet is available with a choice of tapped 12-24, square-punched, Sun® or IBM® rails
- Rack-mount unit marks simplify equipment installation
- Hardware for each rail type is included
- All vertical mounting rails are available in half heights (also sold separately)
- Manufactured from aluminum, custom designed for maximum strength and functionality
- Bolted construction, delivers fully or partially assembled
- Load Rating: 2000 lb (907.2 kg)
- UL Listed: File E212094; Category DUXR (US), DUXR7 (Canada) – Communications - Circuit Accessory

### Cabinet Includes:

- (1) Four-Post Frame (anodized aluminum finish)
- (4) Vertical Mounting Rails & Mounting Hardware
- (2) Locking, Easy-To-Remove Side Panels
- (1) "Quick-Release" Front Door
- (1) "Quick-Release" Rear Door
- (1) Vented Top Panel & Six Cable Access Ports
- (2) Vertical Half Height Cable Managers (wide)
- (4) Leveling Feet
- (1) PDU Mounting Bracket Kit, for two 2.2" (56 mm) CPI PDUs
- (1) Multi-Bay Attachment Hardware Kit
- (4) Floor Anchor Clamps
- (1) Bag of 50 Each #12-24 Rack Channel Mounting Screws with tapped rails
- (1) Bag of 16 each M6 Cage Nuts and Screws, and 25 each #12-24 Cage Nuts and Screws with square-punched rails

\*Note: Special 8' (2.4 m) cabinets are available in standard lead times.

# MegaFrame® Cabinet System 72", 78" and 84" (1830 mm, 1980 mm and 2130 mm)

## Dimensions:

Height Dimensions - in (mm)			
All Cabinet Styles	72 (1830)	78 (1980)	84 (2130)
Usable Vertical Panel Space	38U, 66.50 (1689.1)	42U, 73.50 (1866.9)	45U, 78.75 (2000.3)
Overall Height without Leveling Feet	72.02 (1829.3)	78.02 (1981.7)	84.02 (2130.0)
Overall Height with Leveling Feet	72.92 (1852.2)	78.92 (2004.6)	84.92 (2157.0)
Overall Height with Casters	75.70 (1922.8)	81.70 (2075.2)	87.70 (2230.0)
Frame Vertical Opening	67.90 (1724.7)	73.90 (1877.1)	79.90 (2029.5)

Width Dimensions - in (mm)		
Usable Equipment Panel Width	19" EIA	23" EIA
Overall Width	27.32 (693.9)	31.32 (795.5)
Frame Horizontal Opening	20.20 (513.1)	24.20 (614.7)

Depth Dimension Cabinet Only (With Doors) - in (mm)				
Nominal Cabinet Depth	24 (61)	30 (760)	36 (910)	39 (990)
Maximum Mounting Depth - Rail to Rail	24.00 (609.6)	30.00 (762.0)	36.00 (914.4)	39.00 (990.6)
Overall Depth - Inside Door to Inside Door	27.22 (691.4)	33.22 (843.8)	39.22 (996.2)	42.22 (1072.4)
Overall Depth - Door Face to Door Face	27.62 (701.5)	33.62 (853.9)	39.62 (1006.3)	42.62 (1082.5)

Depth Dimension Frame Only (Without Doors) - in (mm)				
Nominal Cabinet Depth	24 (610)	30 (760)	36 (910)	39 (990)
Maximum Mounting Depth - Rail to Rail	24.00 (609.6)	30.00 (762.0)	36.00 (914.4)	39.00 (990.6)
Overall Depth	26.13 (663.7)	32.13 (816.1)	38.13 (968.5)	41.13 (1044.7)

Shipping Weights - lb (kg)			
All Cabinet Styles - in (mm)	72 (1830)	78 (1980)	84 (2130)
Minimum	152 (68.9)	152 (68.9)	155 (70.3)
Maximum	251 (113.9)	262 (118.8)	287 (130.2)

# M-SERIES MEGAFRAME® CABINET

## Part Number Configurator

When ordering an **M-Series Cabinet**, the part number is always preceded by the letter **M**. Use the part number matrix below to configure your M-Series Cabinet. Choose the **Width**, **Height**, **Depth**, **Cabinet Style**, **Color**, **Door**, and **Shipping Option**.

**Example Cabinet Part Number: M1221-112**

<b>M</b>	<b>W</b>	<b>H</b>	<b>D</b>	<b>S</b>	<b>-</b>	<b>C</b>	<b>D</b>	<b>O</b>
----------	----------	----------	----------	----------	----------	----------	----------	----------

2. Width			
Panel	in	mm	
19" EIA	27.32	693	1
23"	32.32	795	2

3. Height			
in	mm	U	
84	2130	45	0
78	1980	42	1
72	1830	38	2

4. Depth		
in	mm	
24	610	2
30	760	3
39	990	4
36	910	5

*Note: Frame depth listed, doors approximately 1.5" (38 mm).*

8. Shipping Option	
1	Knocked Down
2	Assembled

7. Doors	
0	No front or rear doors
1	Plexiglass front/metal rear
2	Metal front/Metal rear
3	Vented plexiglass front/perforated metal rear
4	Perforated metal front/perforated metal rear

*Perforated metal doors are 63% open for high airflow.*

6. Color <sup>3</sup>	
1	Gray
2	Computer Beige
7	Black

5. Cabinet Style	
0	Tapped rails, top & side panels
1	Tapped rails, top & no side panels
2	Tapped rails, no top or side panels (frame only) <sup>1</sup>
3	Square-punched rails, top & sides
4	Square-punched rails, top, no sides
5	Square-Punched rails, no top or side panels (frame only) <sup>1</sup>



Cabinet Style



Frame Only Style

### Notes:

1. Frame only style cannot be ordered with doors.
2. Color refers to mounting rails and side panels and metal/perforated metal door panels. Frame is silver-colored anodized aluminum.

For further assistance, call 800-834-4969.



## 48" (1220 mm) M-Series MegaFrame® Cabinet

The 48"H (1220 mm) M-Series MegaFrame® Cabinet is designed for space conscious customers who demand value. The cabinet is available in a variety of widths and depths. Multiple cabinets can be mounted side-by-side using optional baying hardware. The cabinet is available in white, black or gray powder-coated finish. The cabinet is also available in a frame only configuration.

Note: When ordering a frame only configuration, the mounting rails have a powder-coated finish based on your color selection. The frame is always silver-colored anodized aluminum.

### Specifications:

- Provides 25U of rack-mount space
- Available in 19" EIA or 23" EIA standard rack widths
- Available in three depths; 24", 30" and 36" (610 mm, 760 mm and 910 mm)
- Load Rating: 2000 lb (907.2 kg)

### Part Number Configurator

When ordering an **M-Series Cabinet**, the part number is always preceded by the letter **M**. Use the part number matrix below to configure your M-Series Cabinet. Choose the **Width**, **Height**, **Depth**, **Cabinet Style**, **Color**, **Door**, and **Shipping Option**.

#### Example Cabinet Part Number: M2530-112

**M** **W** **H** **D** **S** **-** **C** **D** **O**

2. Width			
Panel	in	mm	
19" EIA	27.32	693	1
23"	32.32	795	2

3. Height			
in	mm	U	
48	1220	25	5

4. Depth			
in	mm		
24	610		2
30	760		3
39	990		4
36	910		5

Note: Frame depth listed, doors approximately 1.5" (38 mm).

8. Shipping Option	
1	Knocked Down
2	Assembled

7. Doors	
0	No front or rear doors
1	Plexiglass front/metal rear
2	Metal front/Metal rear
3	Vented plexiglass front/perforated metal rear
4	Perforated metal front/perforated metal rear

Perforated metal doors are 63% open for high airflow.

6. Color <sup>3</sup>	
1	Gray
2	Computer Beige
7	Black

5. Cabinet Style	
0	Tapped rails, top & side panels
1	Tapped rails, top & no side panels
2	Tapped rails, no top or side panels (frame only) <sup>1</sup>
3	Square-punched rails, top & sides
4	Square-punched rails, top, no sides
5	Square-Punched rails, no top or side panels (frame only) <sup>1</sup>



Cabinet Style



Frame Only Style

#### Notes:

1. Frame only style cannot be ordered with doors.
2. Color refers to mounting rails, side panels and metal/perforated metal door panels. Frame is silver-colored anodized aluminum.

For further assistance, call 800-834-4969.





## Air Dam Kit, Cabinet Airflow Baffles

The Air Dam Kit creates a barrier between the cabinet door and the front of equipment along the top, bottom and sides of the cabinet. When used in combination with perforated front and rear doors, the kit helps to channel cool air to the front of equipment and also helps to prevent the mixing of heated air from the rear of the cabinet with cool air at the front of the cabinet.

- 5"D (130 mm) baffles

### Kit consists of:

- (1) Top baffle
- (1) Bottom baffle
- (4) Small side baffles
- (4) Large side baffles
- Installation hardware

Part Number	Description H x W in (mm)	Shipping Weight lb (kg)
<b>For M-Series MegaFrame Cabinet System</b>		
13336-X10	84 (2130) x 19	11 (5.0)
13336-X11	78 (1980) x 19	10 (4.5)
13336-X12	72 (1830) x 19	10 (4.5)
13336-X15	48 (1220) x 19	8 (3.6)
13336-X20	84 (2130) x 23	11 (5.0)
13336-X21	78 (1980) x 23	10 (4.5)
13336-X22	72 (1830) x 23	10 (4.5)
13336-X25	48 (1220) x 23	8 (3.6)

X=color: 1=Gray, 2=Computer Beige, 7=Black

## Fan Kit For M-Series MegaFrame

Fan Kit provides optional ventilation and cooling for the cabinet.

- Four fans mount on two interchangeable frames to fit cabinet top panel
- Grill design and ball-bearing motor offer longer life and quiet operation
- Each fan frame has an IEC C-14 power inlet
- Includes a detachable 15'L (4.6 m) power cord with a molded plug
- Provides up to 400 CFM of ventilation for cabinet
- Can be used on the MegaFrame, SlimFrame and Seismic Frame Cabinets
- UL Recognized

Part Number	Description / Color	Shipping Weight lb (kg)
<b>Cooling Fan Kit - 400 CFM</b>		
12480-701	Black, 115 VAC, 50/60 Hz, NEMA 5-15P	6 (2.7)
12480-702	Black, 230 VAC, 50/60 Hz, NEMA 6-15P	6 (2.7)

<b>Fan Specifications - Each Fan</b>				
Operating Voltage	Airflow	Noise Level (1 Meter Max)	Power Consumption	Operating Frequency
115 VAC	100 CFM	37 dBA	15 Watts	50/60 Hz
230 VAC	100 CFM	37 dBA	15 Watts	50/60 Hz

## Filtered Ventilation System For 30" D (760 mm) MegaFrame® Cabinets

This system has the fans and filters installed at the bottom of the cabinet. Air exhausts through vents in the cabinet top. To allow clearance for cabinet intake air, equipment may not be mounted in the 2U at the bottom of the cabinet. The Standard Filter Cabinet Ventilation System is for the retrofitting of MegaFrame Cabinets with fans already located on the cabinet top.

- For 19" and 23"W x 30"D (760 mm) MegaFrames
- Air Filter Kit with 115 VAC fans provides up to 400 CFM and has an attached 15'L (4.6 m) power cord with a NEMA 5-15P plug
- Air Filter Kit with 230 VAC, 50/60 Hz fans provides up to 400 CFM and has an attached 15'L (4.6 m) power cord with a NEMA 6-15P plug
- Trim-to-fit filter media is readily available from many commercial suppliers or can be ordered from CPI
- 3/8" (9.53 mm) thick filter provides 70-75% dust particle retention
- One filter provided with each kit

*Note: This product is only available for 30" D (760 mm) MegaFrame Cabinets.*

*Unit will generate 48 db noise level.*



12511-50X  
Air Filter Kit with Fans

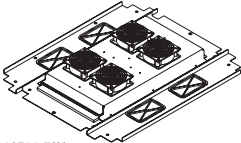

12510-50X  
Air Filter Kit without Fans

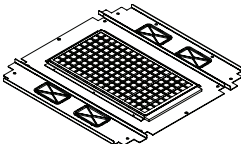

Part Number		Description	Shipping Weight lb (kg)
19"	23"		
<b>Deluxe Filter Cabinet Ventilation System</b>			
12511-501	12511-502	Air Filter Kit w/ 115 VAC Fans	22 (10.0)
12511-503	12511-504	Air Filter Kit w/ 230 VAC Fans	22 (10.0)
<b>Standard Filter Cabinet Ventilation System</b>			
12510-501	12510-502	Air Filter Kit w/o Fans	13 (5.9)
<b>Accessories - in (mm)</b>			
12507-001	12 X 24 X 3/8 (300 x 610 x 9.53) Filter, 6 Pack		1 (0.5)
12505-001	Foam Insert, 2 Pack (for cable ports)		1 (0.5)

## 23"-19" Rail Adapter Kit

Mount your 19"W equipment in a 23"W MegaFrame Cabinet with the 23"-19" Rail Adapter Kit that includes 12 adapters and packaged hardware.

- Made of steel
- Front to rear adjustability remains intact; increases cable routing space
- Rail adapter kit is available for all cabinet heights
- Supports up to 1000 lb (453.6 kg)



Part Number	Description	Shipping Weight lb (kg)
10587-X01	(12) 23"-19" Rail Adapters	5 (2.3)

*X=color: 1=Gray, 2=Computer Beige, 7=Black*

Patented

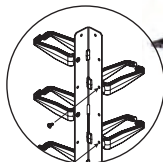

Create two cable pathways using one manager.

## Vertical Cable Manager

Available for 72", 78" and 84" (1830 mm, 1980 mm and 2130 mm) cabinets.

- Includes one pair of sections and eight rings
- Large 3.3"W x 6.5"D (84 mm x 165 mm) heavy duty plastic rings with rounded edges organize and protect cable sheaths
- Position anywhere along horizontal mounting rails
- Use with MegaFrame and Seismic Frame cabinets; use with SlimFrame when bayed without side panels, ships pre-assembled

Part Number	Color Height (pair) in (mm)	Shipping Weight lb (kg)
12465-X05	Cabling Ring Section, 72 (1830)	7 (3.2)
12465-X06	Cabling Ring Section, 78 (1980)	7 (3.2)
12465-X07	Cabling Ring Section, 84 (2130)	7 (3.2)
14068-701	8 Cable Ring Kit, Black	3 (1.4)

X=color: 1=Gray, 2=Computer Beige, 7=Black. Rings are black.

## Enhanced Cable Managers

Enhanced Vertical Managers are available in two sizes for large and extra-large cable capacities. The narrow version can be added to any MegaFrame Cabinet. The wide version is used in any 23"W MegaFrame Cabinet that has been converted into a 19" rack solution with CPI's 23"-19" Rail Adapter Kit. The matching Front-to-Back Managers (sold in pairs) snap-on to the vertical managers and adjust to match the depth of the cable managers.

- Cable openings allow cables to exit by rack-mount unit; openings have rounded edges to protect cables
- The back side has four edge-protected cable pass-through ports for front-to-back cabling
- Includes cover snaps-on and opens to the right or left
- Front-to-Back Managers adjust in depth to connect the front and rear Enhanced Vertical Manager
- Constructed of high-strength, lightweight aluminum

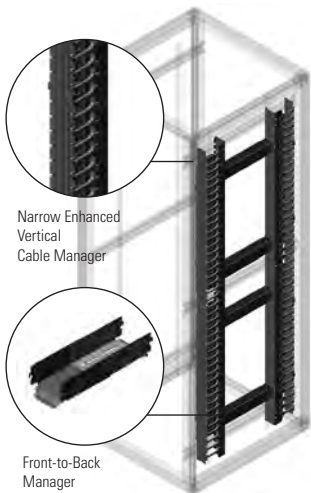

Narrow Enhanced Vertical Cable Manager

Front-to-Back Manager

Shown:  
(2) 13171-700  
(2) 13169-701

Part Number	Description H x W x D in (mm)	Shipping Weight lb (kg)
<b>Enhanced Vertical Manager, Narrow</b>		
13171-702	72 x 3.50 x 5.23 (1830 x 88.9 x 132.8)	9 (4.1)
13171-701	78 x 3.50 x 5.23 (1980 x 88.9 x 132.8)	10 (4.5)
13171-700	84 x 3.50 x 5.23 (2130 x 88.9 x 132.8)	11 (5.0)
<b>Enhanced Vertical Manager, Wide</b>		
13170-702	72 x 4.75 x 8.77 (1830 x 120.7 x 222.8)	11 (5.0)
13170-701	78 x 4.75 x 8.77 (1980 x 120.7 x 222.8)	12 (5.4)
13170-700	84 x 4.75 x 8.77 (2130 x 120.7 x 222.8)	13 (5.9)
<b>Front-to-Back Horizontal Manager, Narrow</b>		
13169-701	2.38 x 1.74 (60.5 x 44.2), 2 each	3 (1.4)
<b>Front-to-Back Horizontal Manager, Wide</b>		
13168-701	2.38 x 3.77 (60.5 x 95.8), 2 each	2 (0.9)

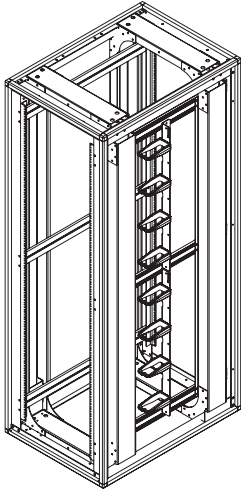

Closeup of reinforced inner frame

## Seismic Frame® Cabinet System

Rated Zone 4 compliant to Bellcore GR-63-CORE for Network Equipment Building Systems (NEBS) Section 4.4.1.1, the Seismic Frame® Cabinet System is designed to withstand the seismic stress of an 8.3 Richter scale earthquake.

Offered in a 84”H x 19”W x 36”D (2130 mm x 910 mm) cabinet solution, the aluminum outer frame provides the sound structural environment necessary for sensitive Information Technology (IT) hardware components.

- Standard 19” EIA rack width
- Features square-punched mounting rails with rack-mount unit marks
- Aluminum outer frame with steel inner frame delivers maximum strength with minimum weight
- Seismic bracing kits and a full line of structural enhancement products are available to support site-specific structural requirements
- Internal cable management provides flexibility for wire routing and fits on-site customization
- Adjustable front-to-rear vertical mounting rails allow use as a standard four-post cabinet or two-channel rack
- Load Rating: 800 lb (362.9 kg) seismic

84”H x 19” W x 36”D (2130 mm x 910 mm ) Seismic Cabinet		
Part Number	Cabinet Door Style	
	Front	Rear
11972-X02	No Front	No Rear
11972-X12	Plexiglass	Metal
11972-X22	Metal	Metal
11972-X32	Vented Plexiglass	Perforated Metal
11972-X42	Perforated Metal	Perforated Metal
84”H x 19” W x 36”D (2130 mm x 910 mm) Without Side Panels		
Part Number	Cabinet Door Style	
	Front	Rear
11973-X02	No Front	No Rear
11973-X12	Plexiglass	Metal
11973-X22	Metal	Metal
11973-X32	Vented Plexiglass	Perforated Metal
11973-X42	Perforated Metal	Perforated Metal

X=color: 1=Gray, 2=Computer Beige, 7=Black. Frame is anodized aluminum.

### Cabinet Dimensions

Usable Height 43U	77.88” (1978.2 mm) or
Usable Depth	36” (910 mm)
Usable Width	19”

Overall Height	84.13” (2136.9 mm)
Overall Depth (w/doors)	39.62” (1006.3 mm)
Overall Width	27.32” (693.9 mm)

Shipping Weight	286 lb Min / 376 lb Max (129.7 kg) / (170.6 kg)
-----------------	--

84”H x 19” W x 36”D (2130 mm x 910 mm) Frame Only**	
Part Number	Cabinet Door Style
11974-X02	Frame Only

X=color: 1=Gray, 2=Computer Beige, 7=Black. \*\*Frame is anodized aluminum.



Requires only 24" (610 mm) of floor space!

## C-Series SlimFrame® Cabinet System

The C-Series SlimFrame® Cabinet System is an ideal storage solution for EIA standard 19" rack-mountable equipment that fits on a standard, 24" (610 mm) access floor tile and provides up to 43U of space. The cabinet can bay to any existing MegaFrame to meet the demand for data storage expansion. Multiple SlimFrame Cabinets bay together by selecting variations without side panels and by using the included Multi-Bay Attachment Hardware Kit.

Two cable management solutions are available for the SlimFrame. CPI's unique Narrow Vertical Cable Manager is included with each cabinet, and the larger vertical cable manager, P/N 12465, is available for greater capacity when buying two or more SlimFrame Cabinets.

### Cabinet Specifications:

- Available in three heights: 72", 78" and 84" (1830 mm, 1980 mm and 2130 mm)
- Available in 19" EIA rack width
- Available in three depths: 22", 30" and 36" (560 mm, 760 mm and 910 mm)
- Available with or without top or side panels
- Side panels are easy-to-remove and locking
- Can be ordered with or without doors in a variety of materials and styles
- Cabinet is available with your choice of tapped #12-24 or square-punched rails
- Rack-mount unit marks simplify equipment installation
- Hardware for each rail type is included
- All vertical mounting rails are available in half heights (also sold separately)
- Manufactured from aluminum, custom designed for maximum strength and functionality
- Bolted construction, delivers fully or partially assembled
- Load Rating: 2000 lb (907.2 kg)

### Cabinet Includes:

- (1) Four-Post Frame (anodized aluminum finish)
- (4) Vertical Mounting Rails & Mounting Hardware
- (2) Locking, Easy-To-Remove Side Panels
- (1) "Quick-Release" Front Door
- (1) "Quick-Release" Rear Door
- (1) Vented Top Panel with Four Cable Access Ports
- (2) Vertical Half Height Cable Managers (narrow)
- (4) Leveling Feet
- (1) PDU Mounting Bracket Kit for two 2.2"W (56 mm) CPI PDUs
- (1) Multi-Bay Attachment Hardware Kit
- (4) Floor Anchor Clamps
- (1) Bag of 50 Each #12-24 Rack Channel Mounting Screws with tapped rails
- (1) Bag of 16 Each M6 Cage Nuts and Screws and 25 Each #12-24

## C-Series SlimFrame® Cabinet System

### Dimensions

Height Dimensions - in (mm)			
All Cabinet Styles	72 (1830)	78 (1980)	84 (2130)
Usable Vertical Panel Space	37U	40U	43U
Overall Height without Leveling Feet	72.00 (1828.8)	78.00 (1981.2)	84.00 (2133.6)
Overall Height with Leveling Feet	72.90 (1851.7)	78.90 (2004.1)	84.90 (2156.5)
Overall Height with Casters	75.38 (1914.7)	81.38 (2067.1)	87.38 (2219.5)
Frame Vertical Opening	64.88 (1648.0)	70.88 (1800.4)	76.88 (1952.8)

Width Dimensions - in (mm)	
Usable Equipment Panel Width	19" EIA
Overall Width	24 (610)
Frame Horizontal Opening	19.84 (500)

Depth Dimension Frame Only ( With Doors) - in (mm)			
Nominal Cabinet Depth	22 (560)	30 (760)	36 (910)
Maximum Mounting Depth - Rail to Rail	21.84 (554.7)	30.00 (762.0)	36.00 (914.4)
Overall Depth - Frame Only	23.96 (608.6)	32.12 (815.8)	38.12 (968.2)
Overall Depth - Door Face to Door Face	25.46 (646.7)	33.62 (853.9)	39.62 (1006.3)

Shipping Weights - lb (kg)			
All Cabinet Styles - in (mm)	72 (1830)	78 (1980)	84 (2130)
Minimum	142 (64.4)	141 (64.0)	149 (67.6)
Maximum	233 (105.7)	249 (112.9)	250 (113.4)

# C-SERIES SLIMFRAME® CABINET

## Part Number Configurator

When ordering an **C-Series Cabinet**, the part number is always preceded by the letter **C**. Use the part number matrix below to configure your C-Series Cabinet. Choose the **Width**, **Height**, **Depth**, **Cabinet Style**, **Color**, **Door**, and **Shipping Option**.

**Example Cabinet Part Number: C1133-732**

**C W H D S - C D O**

2. Width			
Panel	in	mm	
19"EIA	24	610	1

3. Height			
in	mm	U	
84	2130	43	0
78	1980	40	1
72	1830	37	2

4. Depth		
in	mm	
30	760	3
36	910	5
22	560	6

Note: Frame depth listed, doors approximately 1.5" (38 mm).

8. Shipping Option	
1	Knocked Down
2	Assembled

7. Doors	
0	No front or rear doors
1	Plexiglass front/metal rear
2	Metal front/Metal rear
3	Vented plexiglass front/perforated metal rear
4	Perforated metal front/perforated metal rear

Perforated metal doors are 63% open for high airflow.

6. Color <sup>2</sup>	
1	Gray
2	Computer Beige
7	Black

5. Cabinet Style	
0	Tapped rails, top & side panels
1	Tapped rails, top & no side panels
2	Tapped rails, no top or side panels (frame only) <sup>1</sup>
3	Square-punched rails, top & sides
4	Square-punched rails, top, no sides
5	Square-Punched rails, no top or side panels (frame only) <sup>1</sup>



Cabinet Style



Frame Only Style

### Notes:

1. Frame only style cannot be ordered with doors.
2. Color refers to mounting rails, side panels and metal/perforated metal door panels. Frame is silver-colored anodized aluminum.

For further assistance, call 800-834-4969.

## Air Dam Kit, Cabinet Airflow Baffles

The Air Dam Kit creates a barrier between the cabinet door and the front of equipment along the top, bottom and sides of the cabinet. When used in combination with perforated front and rear doors, the Air Dam Kit helps to channel cool air to the front of equipment and also helps to prevent the mixing of heated air from the rear of the cabinet with cool air at the front of the cabinet.

- 5"D (130 mm) baffles

Kit consists of:

- (1) Top baffle
- (1) Bottom baffle
- (4) Small side baffles
- (4) Large side baffles
- Installation hardware



Part Number	Description H x W in (mm)	Shipping Weight lb (kg)
<b>For C-Series SlimFrame Cabinet System</b>		
13336-X10	84 (2130) x 19	11 (5.0)
13336-X11	78 (1980) x 19	10 (4.5)
13336-X12	72 (1830) x 19	10 (4.5)

X=color: 1=Gray, 2=Computer Beige, 7=Black

## Narrow Vertical Cable Manager

This space-saving manager is ideal in CPI's SlimFrame C-Series Cabinets.

- Rings snap-on, making new configurations a simple process
- Control radius helps maintain a proper bend radius in cables
- Includes (2) vertical mounting brackets, (8) pre-assembled cable rings, (1) control radius and (1) hardware kit

Add additional cable rings to the Narrow Vertical Cable Manager.

- Contains (8) black 1.40" H x 1.45" W x 4.13" D plastic U-rings (35.6 mm x 36.8 mm x 104.9 mm)
- U-ring design allows for easy insertion of cables

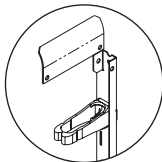

Control radius shown attached to bracket.

Part Number	Description H x W in (mm)	Shipping Weight lb (kg)
11809-X00	For 84"H (2130 mm) Cabinet, 1 Pair 34.7 x 1.75 x 4.13 (881 x 44.5 x 104.9)	5 (2.3)
11809-X01	For 78"H (1980 mm) Cabinet, 1 Pair 31.7 x 1.75 x 4.13 (44.5 x 104.9 x 805)	5 (2.3)
11809-X02	For 72"H (1830 mm) Cabinet, 1 Pair 28.7 x 1.75 x 4.13 (44.5 x 104.9 x 729)	4 (1.8)
11817-001	8 Narrow Cable Ring Kit, Black	1 (0.5)

X=color: 1=Gray, 2=Computer Beige, 7=Black (Rings are black).



# E-SERIES ISP CO LOCATION CABINET SYSTEM

Patented



Optional door-mounted fan keeps equipment cool.

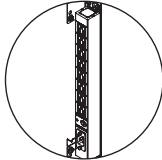

Each compartment includes a 125 VAC, 15 Amp rated power strip.

## E-Series ISP Co Location Cabinet

Three separate, secure compartments in the 7' (2.1 m) cabinet provide 14 usable rack-mount spaces for equipment mounting in each compartment. The E-Series ISP Co Location Cabinet is available in standard 30" and 36" (760 mm and 910 mm) usable mounting depths to accommodate most file server variations. The internal width is 19" or 23".

The cabinet features patented self-squaring construction to allow shipment in both fully assembled and partially assembled configurations. A patented, secure, 3-channel vertical cable raceway provides security for both data and power to each compartment. The cable raceway accommodates either overhead or floor cable access. Separate power distribution to each compartment protects each co-locator's equipment from power surges or outages caused by adjacent co-locators. Front and rear doors are lockable with optional keysets unique for each compartment. Each of the three compartments includes a separate vertical power strip (see bottom of page).

E-Series Cabinets feature an optional door-mounted rear fan that draws in ambient air and expels heated air for effective temperature maintenance. For optimum efficiency when using the fan, the rear door features a solid (rather than perforated) design. Load Rating: 2000 lb (907.2 kg).

### Part Number Configurator

When ordering an **E-Series Cabinet**, the part number is always preceded by the letter **E**. Use the part number matrix below to configure your E-Series Cabinet. Choose the **Width**, **Height**, **Depth**, **Cabinet Style**, **Color**, **Door**, and **Shipping Option**.

**Example Cabinet Part Number: E1051-732**

E	W	H	D	S	-	C	D	O
<b>2. Width/Rails</b>								<b>8. Shipping Option</b>
in								1 Knocked Down
19, Tapped		1						2 Assembled
23, Tapped		2						
19, Square-punched		3						<b>7. Doors</b>
23, Square-punched		4						3 Vented plexiglass front/perforated metal rear
								4 Perforated metal front/perforated metal rear
								<i>Perforated metal doors are 63% open for high airflow.</i>
								<b>6. Color<sup>1</sup></b>
								1 Gray
								2 Computer Beige
								7 Black
								<b>5. Cabinet Style/Accessories</b>
								0 Side panels, no fan, standard locks
								1 Side panels, fan, standard locks
								2 Side panels, no fan, custom-keyed locks
								3 Side panels, fan, custom-keyed locks
								4 Baying, no fan, standard locks
								5 Baying, fan, standard locks
								6 Baying, no fan, custom-keyed locks
								6 Baying, fan, custom-keyed locks



Cabinet Style

*When a fan is included, the rear door is solid with a fan insert.*

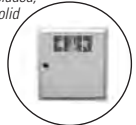

**Notes:**

Color refers to mounting rails, side panels and metal/perforated metal door panels. Frame is silver-colored anodized aluminum.

For further assistance, visit [www.chatsworth.com](http://www.chatsworth.com).

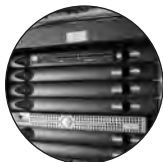

## HotLok® Snap-In Filler Panels

The HotLok Snap-In Filler Panels attach to 19" EIA-310-D and EIA/ECA-310-E compliant square-punched or threaded equipment mounting rails. Universal panels fit .375" (9.5 mm) square-punched equipment mounting rails or M5/M6/#12-24 tapped equipment mounting rails. The cantilevered sealing vanes and snap-spring design create a 99% effective seal between adjacent panels and equipment, blocking most airflow between panels.

Part Number	Description H x W (in)	Shipping Weight lb (kg)
14171-310	1U x 19, Black Panel, Pack of 10	3 (1.4)
14172-310	2U x 19, Black Panel, Pack of 5	3 (1.4)
14171-320	1U x 19, Black Panel with Temperature Strip, Pack of 10	4 (1.8)
14172-320	2U x 19, Black Panel with Temperature Strip, Pack of 10	3 (1.4)

## AisleLok® Acrycell™ Sealing Tape

Seal the gaps between and under cabinets, ensuring that hot and cold air in the data center remain completely separated.



Part Number	Description H x W (in)	Shipping Weight lb (kg)
13876-000	.5" Sealing Tape, Pack of 5, Black .39"W (10 mm) x 32.8"L (10 m)	3 (1.4)
13876-001	1" Sealing Tape, Pack of 5, Black .59"W (15 mm) x 18.4"L (5.6 m)	5 (2.3)
13876-002	2" Sealing Tape, Pack of 5, Black .98"W (25 mm) x 8.5"L (2.6 m)	7 (3.2)

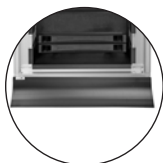

## AisleLok® Under Rack Panel

Seal the gap between the bottom of the cabinet or enclosure and the floor. Uses a strong adhesive backing that remains securely attached.

Part Number	Description H x W (in)	Shipping Weight lb (kg)
13877-002	4.5"H x 27.5"W x 1"D, Pack of 10, Black (115 mm x 699 mm x 25 mm)	2 (0.9)
13877-003	4.5"H x 31.5"W x 1"D, Pack of 10, Black (115 mm x 800 mm x 25 mm)	2 (0.9)

*Note: Not compatible with F-Series TeraFrame Gen 3 or GF-GlobalFrame Gen 2 Cabinet Systems.*



13870-001  
with cover  
13873-001



13576-001



13571-001



13676-001



13874-001

Grommets are now patented.

## KoldLok® Raised Floor Grommet

Reduce bypass airflow, improve data center cooling and block unsealed cable holes with KoldLok® Raised Floor Grommets. Sealing materials resist breaking, deformation and wear for repeated use and are easy to install. Grommets can be positioned in the middle or edge of floor tiles, allowing large bundles of cables and large power connectors to pass-through openings.

- KoldLok Wave™ Raised Floor Grommet offers over 45 in<sup>2</sup> of usable cable area; durable, impact-resistant ABS frame with optional cover for increased safety
- Integral Grommet is a flush-mount design with two styles: Integral Grommet (one-piece) and Split Integral Grommet (two-piece)
- Surface-Mount Grommet is two-piece with three sizes available: Surface-Mount, Large Surface-Mount and Extra-Large Surface-Mount
- Extended Grommet is three-piece and covers a long, narrow slot; available in two sizes: Extended 3" (76 mm) Brush Grommet and Extended 6" (152 mm) Brush Grommet
- Mini Grommet and Round Floor Grommet are smaller flush-mount designs

Part Number		Description	Shipping Weight lb (kg)
1 Each	10 Each		
13870-001	13870-002	KoldLok Wave™ Split Integral Grommet	11 (5.0)
13873-001	13873-002	Cover, KoldLok Wave™ Split Integral Grommet	6 (2.7)
13571-001	13571-002	Integral Grommet	16 (7.3)
13671-001	13671-002	Split Integral Grommet	18 (8.2)
13576-001	13576-002	Surface-Mount Grommet	21 (9.5)
13676-001	13676-002	Large Surface-Mount Grommet	43 (19.5)
13677-001	13677-002	Extra-Large Surface-Mount Grommet	43 (19.5)
13674-001	13674-002	Extended 3" (76 mm) Brush Grommet	29 (13.2)
13675-001	13675-002	Extended 6" (152 mm) Brush Grommet	37 (16.8)
13872-001	13872-002	Mini Grommet	5 (2.3)
13874-001	13874-002	4" (100 mm) Round Grommet	5 (2.3)
13875-001	13875-002	6" (150 mm) Round Grommet	5 (2.3)

Part Number	Overall Size			Cable Opening		Hole in Floor	
	Height	Width	Depth	Width	Depth	Width	Depth
13870-00X	1-7/8" (48 mm)	11" (279 mm)	9" (229 mm)	7-3/4" (197 mm)	5-7/8" (149 mm)	9-1/4" (235 mm)	6-3/4" (172 mm)
13571-00X	1-5/8" (41 mm)	11" (279 mm)	8-1/4" (210 mm)	8" (203 mm)	4" (102 mm)	9-1/4" (235 mm)	6-3/4" (172 mm)
13671-00X	1-5/8" (41 mm)	11" (279 mm)	8-1/4" (210 mm)	8" (203 mm)	4" (102 mm)	9-1/4" (235 mm)	6-3/4" (172 mm)
13576-00X	1-1/8" (29 mm)	11" (279 mm)	8-1/4" (210 mm)	8-1/4" (210 mm)	4" (102 mm)	10" (254 mm)	7-1/4" (184 mm)
13676-00X	1-15/16" (33 mm)	12" (305 mm)	11-3/4" (298 mm)	8-1/4" (210 mm)	4" (102 mm)	10" (254 mm)	9-3/4" (248 mm)
13677-00X	1-15/16" (33 mm)	12" (305 mm)	15" (381 mm)	8-1/4" (210 mm)	4" (102 mm)	10" (254 mm)	13" (330 mm)
13674-00X	1" (25 mm)	24" (610 mm)	4" (102 mm)	22" (559 mm)	2-1/2" (64 mm)	22" (559 mm)	2-1/2" (64 mm)
13675-00X	1" (25 mm)	24" (610 mm)	7" (178 mm)	22" (559 mm)	5-1/2" (140 mm)	22" (559 mm)	5-1/2" (140 mm)
13872-00X	1-1/2" (38 mm)	7-11/16" (195 mm)	5-11/16" (144 mm)	5" (127 mm)	2-1/2" (64 mm)	6" (152 mm)	4" (102 mm)
13874-00X	1.9" (48 mm)	5.61" dia. (143 mm)	-	3.5" dia. (89 mm)	-	4.0" dia. (102 mm)	-
13875-00X	1.9" (48 mm)	7.56" dia. (192 mm)	-	5.3" dia. (135 mm)	-	6.0" dia. (152 mm)	-



Drawer with two-post mounting brackets



Drawer with four-post mounting brackets

## Lockable Storage Drawer

Drawer stores backup media, software, manuals, laptops, test equipment and extra patch cords in close proximity to the cabinet and is now stackable. Drawers are available for 19"W or 23"W racks and cabinets, and include attachment brackets that allow center mounting on two-post racks with 3" or 6"D (80 mm or 150 mm) equipment channels or front and rear attachment to four-post racks and cabinet systems (mounting rails must be adjusted between 24" and 39" (610 mm and 990 mm) in depth).

- Attaches to any CPI freestanding 19"W or 23"W rack or cabinet system
- Available in three heights: 2U, 3U and 4U
- Features 20"D (510 mm) lockable drawer that extends full depth for easy access to stored equipment
- Supports a 100 lb (45.4 kg) load (drawer and top surface combined)

Part Number	Description Drawer Depth in (mm)	Shipping Weight lb (kg)
13082-X19	19" x 2U Drawer, 20 (510)	18 (8.2)
13083-X19	19" x 3U Drawer, 20 (510)	20 (9.1)
13084-X19	19" x 4U Drawer, 20 (510)	22 (10.0)
13082-X23	23" x 2U Drawer, 20 (510)	21 (9.5)
13083-X23	23" x 3U Drawer, 20 (510)	23 (10.4)
13084-X23	23" x 4U Drawer, 20 (510)	25 (11.3)
13185-X01	Drawer Divider, For 3U & 4U Drawers	3 (1.4)

X=color: 1=Gray, 2=Computer Beige, 5=Clear, 7=Black, E=Glacier White.



## Universal Cabinet Light

Fits any 19" EIA or 23" rack or cabinet. It can be mounted in various orientations to direct additional illumination where it is most needed.

- Only 1U; provides 8 Watts of fluorescent light from 115VAC
- On/Off switch and 6' (1.8 m) cord, NEMA 1-15P plug
- White lens with white housing; black bracket

Part Number	Description	Shipping Weight lb (kg)
13393-719	19" Cabinet Light, 8 Watt	3 (1.4)
13393-723	23" Cabinet Light, 8 Watt	3 (1.4)



## Rack Mount Unit Labels

Kits contain four individual label packs, enough for four racks and four cabinets. Labels are constructed of 1/2"W (10 mm) durable polyester film with adhesive backing.

Part Number	Description	Shipping Weight lb (kg)
11927-001	1-45U Labels	1 (0.5)
11927-002	1-58U Labels	1 (0.5)



## Hardware Kits

Tapped Rail Hardware Kits (sold separately)				
Part Number	Nominal Size	Package Of	Finish	Shipping Weight lb (kg)
40605-001	12-24	50	Zinc	1 (0.5)
40605-004	12-24	1,000	Zinc	9 (4.1)
40605-005	12-24	50	Black	1 (0.5)
40605-006	12-24	1,000	Black	9 (4.1)
Square-Punched Hardware Kits (sold separately)				
12637-001	M-6	25	Gold over Zinc	1 (0.5)
12638-001	10-32	25	Zinc	1 (0.5)
12639-001	12-24	25	Black	1 (0.5)

2U



## Fixed Shelf

Use fixed shelves to support equipment without rack-mounted brackets such as modems, CPUs, small power supplies and monitors. Shelves mount to the Universal EIA 5/8" - 5/8" - 1/2" (15.9 mm - 15.9 mm - 12.7 mm) alternating hole pattern of the four vertical mounting rails, and three depths are offered in 18", 24" and 29" (460 mm, 610 mm and 740 mm). Shelves have adjustable mounting depths of 13" to 24" (330 mm to 610 mm) for the 18" (460 mm) shelf, 17" to 28" (430 mm to 710 mm) for the 24" (610 mm) shelf and 24" to 38" (610 mm to 970 mm) for the 29" (740 mm) shelf.

- Made of strong, lightweight aluminum
- Installs using (8) #12-24 screws (not included)
- Supports up to 200 lb (90.7 kg)
- 19" shelves are UL Listed: File E227626; Category NWIN - Accessories

Part Number	Description	Shipping Weight lb (kg)
12336-X19	19"W x 18"D (460 mm), Non-Vented	7 (3.2)
12337-X19	19"W x 18"D (460 mm), Vented	7 (3.2)
12334-X19	19"W x 24"D (610 mm), Non-Vented	9 (4.1)
12335-X19	19"W x 24"D (610 mm), Vented	9 (4.1)
14070-X19	19"W x 29"D (740 mm), Non-Vented	11 (5.0)
14072-X19	19"W x 29"D (740 mm), Vented	10 (4.5)
12336-X23	23"W x 18"D (460 mm), Non-Vented	8 (3.6)
12337-X23	23"W x 18"D (460 mm), Vented	8 (3.6)
12334-X23	23"W x 24"D (610 mm), Non-Vented	10 (4.5)
12335-X23	23"W x 24"D (610 mm), Vented	10 (4.5)
14070-X23	23"W x 29"D (740 mm), Non-Vented	12 (5.4)
14072-X23	23"W x 29"D (740 mm), Vented	11 (5.0)

X=Color: 1=Gray, 2=Computer Beige, 7=Black



## Rack-Mount Cable Shelf

Use Rack-Mount Cable Shelf in any 19"W CPI cabinet equipped with an Air Dam Kit to provide a front-to-rear pathway for cables. Cables pass through brush-sealed ports along the front of the shelf. Rack-Mount Cable Shelf uses 1U and will fit in cabinets with mounting rails set between 22" and 40"D (560 mm and 1020 mm).

Part Number	Description	Shipping Weight lb (kg)
13517-701	1U x 19, Black	17 (7.7)

2U



## Sliding Shelf

Shelves mount to the four vertical mounting rails. Two depths are offered in 18" and 24" (460 mm and 610 mm) to provide clearance for cables, ventilation and power strips. Shelves have adjustable mounting depths of 14" to 24" (360 mm to 610 mm) for the 18" (460 mm) shelf and 18" to 30" (460 mm to 760 mm) for the 24" (610 mm) shelf.

- Extends 17" (430 mm) for 18"D (460 mm) shelf and 23" (580 mm) for 24"D (610 mm)
- Offered in 18" (460 mm) or 24" (610 mm) depth, vented or non-vented
- Made of strong, lightweight aluminum
- Shelf locks in closed or fully open position, providing stability
- Ships fully assembled; installs using (8) #12-24 screws (not included)
- Fits cabinets that are 30"D (760 mm) or less
- Accommodates the Monitor Tie-Down Bracket, P/N 11725-X01
- Supports up to 140 lb (63.5 kg)

Part Number	Description	Shipping Weight lb (kg)
12338-X19	19"W x 18"D (460 mm), Non-Vented	7 (3.2)
12339-X19	19"W x 18"D (460 mm), Vented	7 (3.2)
12345-X19	19"W x 24"D (610 mm), Non-Vented	9 (4.1)
12346-X19	19"W x 24"D (610 mm), Vented	9 (4.1)
12338-X23	23"W x 18"D (460 mm), Non-Vented	8 (3.6)
12339-X23	23"W x 18"D (460 mm), Vented	8 (3.6)
12345-X23	23"W x 24"D (610 mm), Non-Vented	10 (4.5)
12346-X23	23"W x 24"D (610 mm), Vented	10 (4.5)

X=Color: 1=Gray, 2=Computer Beige, 7=Black

1U



Shelf extends from 20" - 36" (510 mm - 910 mm) in depth. Mounting brackets included but not shown.

## Low Profile Fixed Shelf

Unique telescoping design delivers between 20" and 36" (510 mm and 910 mm) of continuous support for up to 100 lbs (45.4 kg) of equipment in less than 1U of rack-mount space.

- Shelf bracket provides front and rear support, attaching with single screw to mounting rails
- Available in 19" EIA and 23" EIA widths, providing 17.5" and 21.5" (445 mm and 546 mm) surface space respectively
- Made of steel
- Supports up to 100 lb (45.4 kg)
- 19" shelves are UL Listed

Part Number	Description	Shipping Weight lb (kg)
12573-X19	19"W Solid Shelf	16 (7.3)
12573-X23	23"W Solid Shelf	18 (8.2)
12610-X19	19"W Vented Shelf	15 (6.8)
12610-X23	23"W Vented Shelf	17 (7.7)

X=Color: 1=Gray, 2=Computer Beige, 7=Black

2U

Patented

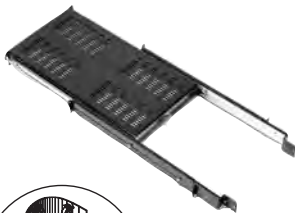

Flexible cable manager

## 32" Deep (810 mm) Sliding Shelf

Many storage solutions may cause kinking, twisting and cutting of cables during shelf extension and retraction. CPI's flexible polycarbonate belt, which fits in the rear undercarriage, solves these problems. This belt easily attaches to either the left or right side of the vertical bracket and contains eight molded releasable clips that accommodate cable bundles measuring up to 1" (25.4 mm) in diameter.

- Supports up to 160 lb (72.6 kg) using less than 2U
- Locks in the closed position
- Open easily with accessible front lock levers, providing greater stability while accommodating deep servers
- Maximum usable shelf space of up to 32" (810 mm)
- Cable management belt provides greater flexibility in the storage of wire bundles
- Designed for 36" or 39"D (910 mm or 990 mm) cabinets

Part Number	Style	Shipping Weight lb (kg)
<b>19"W x 32"D (810 mm) Sliding Shelf</b>		
11913-X19	Vented	25 (11.3)
<b>19"W x 32"D (810 mm) Sliding Shelf</b>		
11914-X19	Non-Vented	25 (11.3)
<b>23"W x 32"D (810 mm) Sliding Shelf</b>		
11913-X23	Vented	25 (11.3)
<b>23"W x 32"D (810 mm) Sliding Shelf</b>		
11914-X23	Non-Vented	25 (11.3)

X=Color: 1=Gray, 2=Computer Beige, 7=Black

2U

Patented

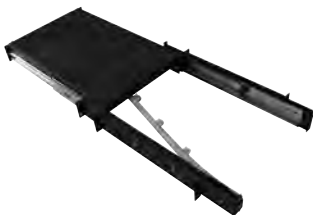

Patented shelf extends a full 24" (610 mm).

## Extra Heavy Duty Sliding Shelf

Shelf supports up to 300 lb (136.1 kg) and uses only 2U, providing 26" (660 mm) usable depth.

- Flexible cable management belt eliminates kinking, bending or cutting of cable
- Adjustable mounting depth of 20" to 34" (510 mm to 860 mm)
- 19" shelf provides 17.5" (445 mm) usable width
- 23" shelf provides 21.5" (546 mm) usable width
- Locks in fully closed or open position

Part Number	Description	Shipping Weight lb (kg)
12700-X19	19"W Solid Shelf	29 (13.2)
12700-X23	23"W Solid Shelf	30 (13.6)

X=Color: 1=Gray, 2=Computer Beige, 7=Black



## AISLE CONTAINMENT SOLUTIONS

Aisle Containment Solutions by Chatsworth Products (CPI) utilize Passive Cooling to create effective and efficient thermal solutions at every level of infrastructure deployment.

CPI's latest innovation in Aisle Containment has sharpened focus on total air isolation, resulting in a solution that helps reduce energy costs and optimizes power availability. The flexibility to deploy the containment system into the hot or cold aisle provides the ability to overcome facility challenges like limited ceiling height, complicated overhead pathways or the inability to add a drop ceiling or overhead return ducts. Frame Supported options support colocation facilities and roll in/roll out deployment, allowing cabinets to be added or omitted from contained aisles, while maintaining air isolation.

### Currently available in four solutions:

- Build To Spec (BTS) Hot Aisle Containment (HAC)
- Cabinet Supported Hot Aisle Containment (HAC)
- Frame Supported Hot Aisle Containment (HAC)
- Cabinet Supported Cold Aisle Containment (CAC)

### CPI Aisle Containment Solutions feature:

- Effectively utilize 100% of supplied air and reduce chilled air waste
- Improve CRAC efficiency because of the higher supply-to-return temperature differences
- Support 4x higher heat and power densities (6 kW to 30+ kW)
- Eliminate Hot Spots
- Allow increased room temperature, higher set points on cooling equipment and chilled water temperatures for more free cooling hours using low-cost economizers



## Aisle Containment Door Assembly

Use with all CPI containment solutions. The door assembly encloses the end of an aisle between adjacent cabinet rows. Available in single- and double-door assemblies. Fits snugly against the cabinets, and features an integrated interior handle, full height vertical edge seals, height adjustable brush floor seals and a magnetic door seal. Automatic close system ensures maximum performance by minimizing airflow disruptions. Low-profile design conceals installation hardware.



Aisle Containment Door Assembly Double Door

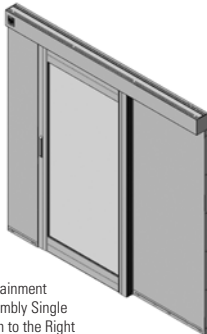

Aisle Containment Door Assembly Single Door, Open to the Right

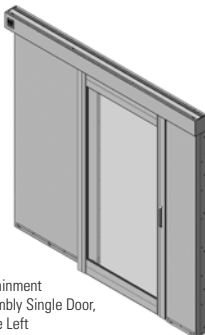

Aisle Containment Door Assembly Single Door, Open to the Left

Aisle Containment Door Assembly		
Part Number & Finish		Description
Black	Glacier White	
Double Door		
32770-701	32770-E01	With Painted Door Frames
32770-702	32770-E02	With Anodized Aluminum Door Frames
Single Door, Opens To The Right		
32780-702	32780-E02	With Painted Door Frames
32780-704	32780-E04	With Anodized Aluminum Door Frames
Single Door, Opens To The Left		
32780-701	32780-E01	With Painted Door Frames
32780-703	32780-E03	With Anodized Aluminum Door Frames

*Notes: Double door spans two to three tile aisles and has a 42"W (1067 mm) door opening. Single door is right or left opening, spans two tile aisles and has a 32"W (812 mm) door opening. Order one Floor Mounting Template for each site.*

## Floor Mounting Template

Provides a pattern for marking and drilling the floor when installing Aisle Containment Doors. Reusable, only one required.

Part Number & Finish	Description
Black	
32875-701	For Aisle Containment Double-Door
32875-702	For Aisle Containment Single Door

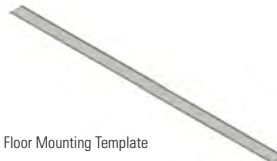

Floor Mounting Template

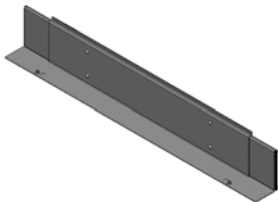

## Door Top Seal Kit

Use with Cabinet Supported Solutions only. Flush mount and offset mount versions available in three size ranges. Seals the gap above the door when the door is attached to cabinets over 88" (2235 mm) tall.

Part Number & Finish		Description
Black	Glacier White	
<b>Door Top Seal Kit , For Use With Door Standoff Kit</b>		
32817-704	32817-E04	Adjusts from 48"W (1219 mm) to 59"W (1500 mm)
32817-705	32817-E05	Adjusts from 59"W (1500 mm) to 70"W (1775 mm)
32817-706	32817-E06	Adjusts from 70"W (1775 mm) to 81"W (2050 mm)
<b>Door Top Seal Kit , For Use Without Door Standoff Kit</b>		
32817-701	32817-E01	Adjusts from 48"W (1219 mm) to 59"W (1500 mm)
32817-702	32817-E02	Adjusts from 59"W (1500 mm) to 70"W (1775 mm)
32817-703	32817-E03	Adjusts from 70"W (1775 mm) to 81"W (2050 mm)



## Door Standoff Kit

Offsets door from the side of the cabinets, so floor mounting hardware is not located over the edges of the floor tiles. Provides approximately 2.5" (64 mm) standoff.

Part Number & Finish		Description
Black	Glacier White	
32870-701	32870-E01	For Containment Double Door Assembly
32870-702	32870-E02	For Containment Single Door Assembly

## Door Mounting Bracket

Secures the Aisle Containment Door Assembly to the tops of the cabinets. Two versions for use with or without Door Standoff Kit (P/N 32870). Includes two brackets; available in three height ranges.

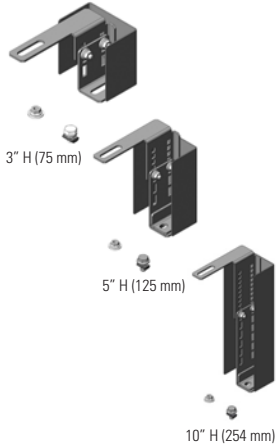

Part Number & Finish		Description
Black	Glacier White	
<b>Door Mounting Bracket Kit (use with Standoff Kit)</b>		
32805-703	32805-E03	3"H (75 mm), For 85.3"H (2167 mm) to 91.4"H (2322 mm) Cabinets
32805-704	32805-E04	5"H (125 mm), For 82.6"H (2098 mm) to 94.2"H (2393 mm) Cabinets
32805-705	32805-E05	10"H (254 mm), For 77.8"H (1976 mm) to 98.9"H (2512 mm) Cabinets
<b>Door Mounting Bracket Kit (use without Standoff Kit)</b>		
32805-700	32805-E00	3"H (75 mm), For 85.3"H (2167 mm) to 91.4"H (2322 mm) Cabinets
32805-701	32805-E01	5"H (125 mm), For 82.6"H (2098 mm) to 94.2"H (2393 mm) Cabinets
32805-702	32805-E02	10"H (254 mm), For 77.8"H (1976 mm) to 98.9"H (2512 mm) Cabinets

## Containment Floor Seal Kit

Floor Seal Kits block bypass airflow underneath cabinets to prevent leakage from the contained aisle. Use one front seal kit on each cabinet and one side seal kit on each cabinet row, ordered separately.

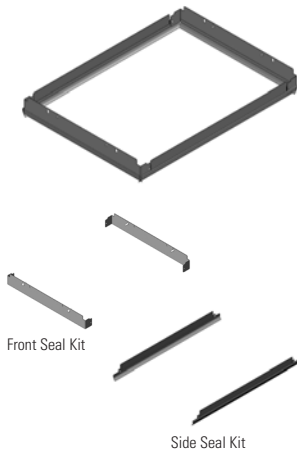

Part Number & Finish		Description
Black	Glacier White	
39208-700	39208-E00	Front Seal, for 23.6"W (600 mm) Cabinets
39208-701	39208-E01	Front Seal, for 27.6"W (700 mm) Cabinets
39208-703	39208-E03	Front Seal, for 29.5"W (750 mm) Cabinets
39208-702	39208-E02	Front Seal, for 31.5"W (800 mm) Cabinets
39209-700	39209-E00	Side Seal, for 31.5"W (800 mm) Frames
39209-708	39209-E08	Side Seal, for 39.4"W (1000 mm) Frames
39209-710	39209-E10	Side Seal, for 41.3"W (1050 mm) Frames
39209-712	39209-E12	Side Seal, for 43.3"W (1100 mm) Frames
39209-716	39209-E16	Side Seal, for 47.2"W (1200 mm) Frames

*Note: The part numbers listed above are for GF-Series GlobalFrame Gen 2 Cabinets and F-Series TeraFrame Gen 3 Cabinets. Other sizes and styles are available. Contact CPI Technical Support for assistance.*



## Build To Spec (BTS) Hot Aisle Containment (HAC) Solution

The Build To Spec Kit Hot Aisle Containment (HAC) Solution by Chatsworth Products (CPI) features a field-fabricated duct that is used over a contained hot aisle as part of a closed hot air return. This solution integrates with perimeter cooling, provides immediate improved cooling efficiency and is compatible with economization methods. It is ideal for retrofit applications over a mix of cabinets, including cabinets of varying heights, widths and depths.

### Solution Overview

- Field-fabricated duct accommodates site differences and existing conditions
- Compatible with a mix of cabinets – different heights, widths and depths in the same row
- Elevated, single-piece duct allows cabinets to be removed, omitted or replaced as required
- Translucent duct panels and transparent door panels allow light to enter the contained aisle
- Doors close automatically to maintain containment and reduce recovery time
- A complete solution maximizes performance with baffles to seal around and within the cabinets and contained aisle
- Durable construction and maintenance-free design provide many years of use

- 1** Build To Spec Kit (BTS) – Includes all of the components needed to construct a ceiling-supported or cabinet-supported duct to capture and direct airflow in the contained aisle. This design adapts to a mix of cabinets and allows cabinets to be changed when required. Used as part of a closed return for the air handling system.
- 2** Universal Bulb Seal – Edge seal used around drop panels to seal gaps above shorter cabinets. Bulb seal attaches directly to the edge of the panel.
- 3** Full Height Cabinet Blanking Panel – Translucent panel and seal used to fill gaps where entire cabinets are omitted from the cabinet row or when adjacent cabinet rows are different lengths. Easy to install or remove in the field.
- 4** Aisle Containment Door Assembly – Sliding double doors (shown) or single door, both with automatic closing feature and large transparent panel(s). Doors attach to the cabinets at the ends of the aisle to seal the ends of the contained aisle.
- 5** Door Standoff Kit – Optional kit used when cabinets are placed over a raised floor to offset the door approximately 2.5" (64 mm).
- 6** Door Top Seal Kit (**not shown**) – Optional kit used when doors are shorter than cabinets to seal the gap between the top of the door and the top of the cabinets.
- 7** Door Mounting Bracket Kit (**not shown**) – Adjustable height brackets used to attach the Aisle Containment Door Assembly to the tops of cabinets.
- 8** Aisle Containment Cabinet to Floor Seal Kit **or** AisleLok™ Under Rack Panel – Cabinet-specific trim panels used along the base of cabinets to seal the gap between the floor and the bottom of the cabinet frame. If not available from the cabinet manufacturer, trim and adhere AisleLok Under Rack Panel to seal gaps under cabinets.

### Containment Accessories:

- Floor Mounting Template

## HAC Ordering Information

The specific combination of components needed to create a complete BTS Hot Aisle Containment (HAC) Solution will depend on a number of factors, including room layout, ceiling height and what types of cabinets models are selected.

To ensure you have a complete solution that addresses site- and cabinet-specific requirements, please contact CPI Technical Support for assistance developing a Bill of Materials (BOM).

Based on your input, CPI Technical Support will propose a complete solution with a drawing and detailed BOM. They will take the time to explain each selection, so you have a complete understanding of how CPI solutions will provide desired results.

<b>Example Bill Of Materials (BOM)</b>			
Item	Part Number	Description	Qty
<b>BTS Hot Aisle Containment (HAC) Solution</b>			
1	33000-713	BTS Kit, 96"H (2438 mm) x 96"W (2438 mm) x 282"L (7163 mm), Black	1
2	33003-002	Universal Bulb Seal, 96"L (2438 mm), Pack of 10	1
3	33002-701	Full Height Cabinet Blanking Panel, 94"H (2387 mm) x 48"W (1219 mm), Pack of 2	1
4	32770-702	Aisle Containment Double Door Assembly, Black with Anodized Door Frames	2
5	32870-701	Door Standoff Kit, for Double Door Assembly	2
6	32817-706	Door Top Seal Kit, For Use With Door Standoff Kit, 70"W (1775 mm) to 81"W (2050 mm)	2
7	32805-703	Door Mounting Bracket Kit, 3"H (75 mm)	2
8	13877-002	AisleLok Under Rack Panel, 4"H (115 mm) x 23.6"W (600 mm), Black, Pack of 10	1
	13877-003	AisleLok Under Rack Panel, 4.5"H (115 mm) x 31.5"W (800 mm), Black, Pack of 10	1
<b>Recommended Accessories</b>			
	32875-701	Installation Template, Aisle Containment Double Door Assembly	1
	34537-702	Snap-In Filler Panel, 1U x 19"EIA, Black, Pack of 50	2
	34538-702	Snap-In Filler Panel, 2U x 19"EIA, Black, Pack of 50	2
	13876-002	AisleLok Acrycell Sealing Tape, 2"W (50 mm), 8.5'L (2.6 m), Black, Pack of 5	1
	13671-002	KoldLok Split Integral Raised Floor Grommet, 10 Pack, Black	2

For a more detailed analysis of your site, CPI offers a Pre-Installation Site Survey, a service where a CPI Technical Representative visits your site to provide a more detailed recommendation. To help ensure an optimized aisle containment installation, CPI offers On-Site Installation Supervision Services, which include related training and examination of the initial pods. Both Pre-Installation Site Surveys and On-Site Installation Supervision Support are especially important if there are special conditions, concerns or required customization.

All suggestions and performance statements are based on using an overall approach to airflow containment through the use of CPI products and solutions. For more information about CPI's Aisle Containment Services or products, call 800-834-4969, email [techsupport@chatsworth.com](mailto:techsupport@chatsworth.com) or contact your Regional Sales Manager.

All products quoted are subject to availability based on manufacturing capacity, and shipping dates should be considered estimates only. While every effort has been made to ensure the accuracy of all information, CPI does not accept liability for any errors or omissions and reserves the right to change information and descriptions of listed services and products.

# BUILD TO SPEC (BTS) HOT AISLE CONTAINMENT (HAC) SOLUTIONS



*BTS Kit arrives on a pallet and includes eight unique components designed for easy installation and customization on-site.*



*BTS Kit assembled.*

Part Number & Finish		BTS Kit						Ref Row Length by # of Tiles
		Description						
Black	Glacier White	Height		Width		Length		
		in	mm	in	mm	in	mm	
33000-701	33000-E01	48	1219	96	2438	94	2388	3
33000-702	33000-E02	48	1219	96	2438	188	4775	7
33000-703	33000-E03	48	1219	96	2438	282	7163	11
33000-704	33000-E04	48	1219	96	2438	376	9550	15
33000-705	33000-E05	48	1219	96	2438	470	11938	19
33000-706	33000-E06	48	1219	96	2438	564	14326	23
33000-707	33000-E07	48	1219	96	2438	658	16713	27
33000-708	33000-E08	48	1219	96	2438	752	19101	31
33000-709	33000-E09	48	1219	96	2438	846	21488	35
33000-710	33000-E10	48	1219	96	2438	940	23876	39
33000-711	33000-E11	96	2438	96	2438	94	2388	3
33000-712	33000-E12	96	2438	96	2438	188	4775	7
33000-713	33000-E13	96	2438	96	2438	282	7163	11
33000-714	33000-E14	96	2438	96	2438	376	9550	15
33000-715	33000-E15	96	2438	96	2438	470	11938	19
33000-716	33000-E16	96	2438	96	2438	564	14326	23
33000-717	33000-E17	96	2438	96	2438	658	16713	27
33000-718	33000-E18	96	2438	96	2438	752	19101	31
33000-719	33000-E19	96	2438	96	2438	846	21488	35
33000-720	33000-E20	96	2438	96	2438	940	23876	39
33000-721	33000-E21	48	1219	144	3658	94	2388	3
33000-722	33000-E22	48	1219	144	3658	188	4775	7
33000-723	33000-E23	48	1219	144	3658	282	7163	11
33000-724	33000-E24	48	1219	144	3658	376	9550	15
33000-725	33000-E25	48	1219	144	3658	470	11938	19
33000-726	33000-E26	48	1219	144	3658	564	14326	23
33000-727	33000-E27	48	1219	144	3658	658	16713	27
33000-728	33000-E28	48	1219	144	3658	752	19101	31
33000-729	33000-E29	48	1219	144	3658	846	21488	35
33000-730	33000-E30	48	1219	144	3658	940	23876	39
33000-731	33000-E31	96	2438	144	3658	94	2388	3
33000-732	33000-E32	96	2438	144	3658	188	4775	7
33000-733	33000-E33	96	2438	144	3658	282	7163	11
33000-734	33000-E34	96	2438	144	3658	376	9550	15
33000-735	33000-E35	96	2438	144	3658	470	11938	19
33000-736	33000-E36	96	2438	144	3658	564	14326	23
33000-737	33000-E37	96	2438	144	3658	658	16713	27
33000-738	33000-E38	96	2438	144	3658	752	19101	31
33000-739	33000-E39	96	2438	144	3658	846	21488	35
33000-740	33000-E40	96	2438	144	3658	940	23876	39

**Notes:**

- The BTS Kit includes the materials needed to create the duct over the cabinets and contained aisle.
- The duct should be slightly larger than the contained aisle; a minimum of 10" (250 mm) wider and 3" (75 mm) longer, so that it overlaps the adjacent cabinets.
- All containment packages come standard with adequate brackets to accommodate a ceiling- or cabinet-supported solution. Order ceiling or cabinet installation hardware separately.
- Doors, full height cabinet blanking panels and additional materials for header/drop panels over cabinets must be ordered separately.



## Universal Bulb Seal

Attaches to Full Height Filler Panels Support Extrusion to hold panel and provide edge seal. Trim length to match requirements.

- Includes: (2) or (10) each, 96" L (2387 mm) bulb seals
- Material: Plastic; bulb is flexible PVC (UL 94HB or UL 94VO), support is rigid PVC (UL 94VO), barbs in support are flexible Alcryl (UL 94HB)
- Flammability Standards: UL 94HB or UL 94VO, see Material

Part Number & Finish	Description
<b>Black</b>	
33003-001	96" L (2438), Pack of 2
33003-002	96" L (2438), Pack of 10

*Note: Use as an edge seal around drop panels over cabinets.*



## Full Height Cabinet Blanking Panel For BTS Kit

Fills gaps when a cabinet is omitted from the aisle/cabinet row. Fits snugly and contains air in the enclosed hot aisle between the sides of adjacent rows. Center panel is translucent and sides are painted. Includes horizontal and vertical seals; order hardware separately.

- Includes: 0.23" (6 mm) thick, 48"W (1219 mm) x 96"L (2387 mm) translucent panels, Universal Bulb Seal and aluminum extrusion supports
- Material: polycarbonate sheet and aluminum extrusion
- Surface Burning Characteristics of panels: ASTM E-84 (UL-723) Flame Spread Index = 0, Smoke Developed Index <=85.
- Finish: clear (translucent); extrusions are painted

Part Number & Finish		Description
Black	Glacier White	
33002-701	33002-E01	94"H (2387 mm) x 48"W (1219 mm), Pack of 2
33002-702	33002-E02	94"H (2387 mm) x 48"W (1219 mm), Pack of 10

*Note: Center panel is translucent, sides and brackets are painted.*



# CABINET SUPPORTED HOT AISLE CONTAINMENT (HAC) SOLUTIONS

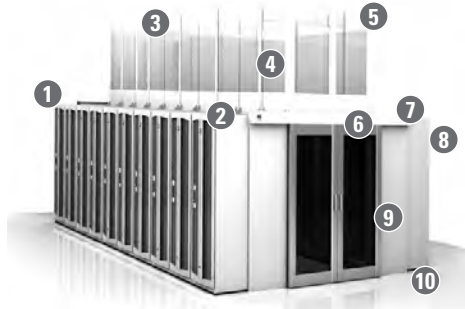

## Cabinet Supported Hot Aisle Containment (HAC) Solution

The Cabinet Supported Hot Aisle Containment (HAC) Solution features an exhaust duct over a contained hot aisle as part of a closed hot air return. This solution integrates with perimeter cooling, provides immediate improved cooling efficiency and is compatible with economization methods. This system can be expanded by simply adding a pair of cabinets and individual cabinet supported panels to create the duct. It is ideal for small or medium scale data center computer rooms that are gradually adopting containment for "hot zones" as they expand or retrofit the site.

### Solution Overview

- 1 CPI Cabinet System – Create cabinet rows using F-Series TeraFrame® Gen 3 Cabinets or GF-Series GlobalFrame® Gen 2 Cabinets. Configure cabinets with Thermal Management Accessories that block airflow through and around cabinets.
  - 2 Cabinet Supported Exhaust Duct Panel Kit – Attaches to the top of the cabinet to form part of the exhaust duct over the contained aisle. Order one per cabinet to match cabinet width.
  - 3 Cabinet Supported Exhaust Duct Horizontal Support Beam – Intermediate support beam used between every other cabinet to provide lateral support for the duct across the contained aisle.
  - 4 Cabinet Supported Exhaust Duct H-Seal – Use to splice and seal panels on adjacent Aisle Containment Exhaust Duct Panel Kits in-between Aisle Containment Exhaust Duct Horizontal Support Beams.
  - 5 Aisle Containment Exhaust Duct Edge Seal – Flexible, curved seal used around the top of the duct to create a complete seal with overhead drop ceiling tiles.
  - 6 Cabinet Supported Exhaust Duct End Panel Kit – Forms the end of the exhaust duct over a contained aisle.
  - 7 Door Mounting Bracket Kit – Adjustable height brackets used to attach the Aisle Containment Door Assembly to the tops of cabinets.
  - 8 Door Standoff Kit – Optional kit used when cabinets are placed over a raised floor to offset the door approximately 2.5" (64 mm) away from the side of cabinets so that the bottom of the door is not located over the edges of floor tiles.
  - 9 Aisle Containment Door Assembly – Sliding double doors (shown) or single door, both with automatic closing feature and large transparent panel(s). Attaches to the ends of cabinets to seal the ends of the contained aisle.
  - 10 Aisle Containment Cabinet To Floor Seal Kit – Cabinet-specific trim panels used along the base of cabinets to seal the gap between the floor and the bottom of the cabinet frame.
- Containment Accessories:**
- Adjustable Filler Panel
  - Door Top Seal Kit
  - GlobalFrame Door Rail Support Kit

# CABINET SUPPORTED HOT AISLE CONTAINMENT (HAC) SOLUTIONS

## HAC Ordering Information

The specific combination of components needed to create a complete Cabinet Supported Hot Aisle Containment (HAC) Solution will depend on a number of factors including room layout, ceiling height, whether there is a slab or raised access floor and what type of cabinet models are selected.

To ensure you have a complete solution that addresses site- and cabinet-specific requirements, please contact CPI Technical Support for assistance developing a Bill of Materials (BOM).

Based on your input, CPI Technical Support will propose a complete solution with a drawing and detailed BOM. They will take the time to explain each selection, so you have a complete understanding of how the CPI solutions will provide the desired results.

Example Bill Of Materials (BOM)			
Item	Part Number	Description	Qty
<b>Cabinet Supported Hot Aisle Containment (HAC) Solution</b>			
1	FF1U-113C-E42-B	F-Series TeraFrame Gen 3 Cabinet, 45U, 23.6"W (600 mm) x 47.2"D (1200 mm), Glacier White	20
2	32830-E01	Cabinet Supported Exhaust Duct Panel Kit, 23.6"W (600 mm), Glacier White	20
3	32820-E01	Cabinet Supported Exhaust Duct Horizontal Support Beam, Glacier White	5
4	32835-000	Cabinet Supported Exhaust Duct H-Seal, 4'L (1.2 m), 2 Pack, Clear	4
5	32836-001	Aisle Containment Exhaust Duct Edge Seal, 8'L (2.4 m), 6 Pack, Clear	1
6	32850-E01	Cabinet Supported Exhaust Duct End Panel Kit, 48"W (1200 mm), Glacier White	2
7	32805-E04	Door Mounting Bracket Kit, 5"H (125 mm), With Offset, Glacier White	2
8	32870-E01	Door Standoff Kit, For Double Door, Glacier White	2
9	32770-E02	Aisle Containment Double Door Assembly, Clear Doors, Glacier White	2
10	39208-E00	Cabinet To Floor Front Seal Kit, F-Series TeraFrame Gen 3 Cabinet, 23.6"W (600 mm)	20
	39209-E16	Cabinet To Floor Side Seal Kit, F-Series TeraFrame Gen 3 Cabinet, 51.0"D (1297 mm)	4
<b>Recommended Accessories</b>			
	32875-701	Installation Template, Aisle Containment Double Door Assembly	1
	39085-E03	Air Dam Kit For F-Series TeraFrame Gen 3 Cabinets, Glacier White	20
	39132-E00	Bottom Panel for F-Series TeraFrame Gen 3 Cabinet, Glacier White	20
	34537-E02	Snap-In Filler Panel, 1U x 19"EIA, 50 Pack, Glacier White	2
	34538-E02	Snap-In Filler Panel, 2U x 19"EIA, 50 Pack, Glacier White	2
	13671-002	KoldLok Split Integral Raised Floor Grommet, 10 Pack, Black	2

For a more detailed analysis of your site, CPI offers a Pre-Installation Site Survey, a service where a CPI Technical Representative visits your site to provide a more detailed recommendation. To help ensure an optimized aisle containment installation, CPI offers On-Site Installation Supervision Services, which include related training and examination of the assembled solution. Both Pre-Installation Site Surveys and On-Site Installation Supervision Support are especially important if there are special conditions, concerns or required customization.

All suggestions and performance statements are based on using an overall approach to airflow containment through the use of CPI products and solutions. For more information about CPI's Aisle Containment services or products, call 800-834-4969, email techsupport@chatsworth.com or contact your Regional Sales Manager.

All products quoted are subject to availability based on manufacturing capacity, and shipping dates should be considered estimates only. While every effort has been made to ensure the accuracy of all information, CPI does not accept liability for any errors or omissions and reserves the right to change information and descriptions of listed services and products.

# CABINET SUPPORTED HOT AISLE CONTAINMENT (HAC) SOLUTIONS



32830-701



32820-701



32850-701

## HAC Ordering Information

### Cabinet Supported Exhaust Duct Panel Kit

Attaches to the top of the cabinet and captures and vents air from an aisle between adjacent rows of cabinets. Use as part of a closed return for the air handling system. Forms part of the Cabinet Supported Exhaust Duct. Order one per cabinet.

### Cabinet Supported Exhaust Duct Horizontal Support Beam

Attaches between adjacent Cabinet Supported Exhaust Duct Panel Kit and adjusts in width to span the contained aisle; connects the sides of the duct along the cabinet row. Use between every other cabinet/panel to provide lateral support for the duct. Order one every other cabinet.

### Cabinet Supported Exhaust Duct End Panel Kit

Attaches to the Cabinet Supported Exhaust Duct Panel Kit and forms the end of the exhaust duct over a contained aisle. Use as part of a closed return for the air handling system.

Part Number & Finish		Description
Black	Glacier White	
<b>Cabinet Supported Exhaust Duct Panel Kit</b>		
32830-701	32830-E01	For 23.6"W (600 mm) Cabinet
32830-702	32830-E02	For 24.0"W (610 mm) Cabinet
32830-703	32830-E03	For 27.6"W (700 mm) Cabinet
32830-704	32830-E04	For 29.5"W (750 mm) Cabinet
32830-705	32830-E05	For 31.5"W (800 mm) Cabinet
32830-706	32830-E06	For 40.0"W (1016 mm) Cabinet
32830-707	32830-E07	For 47.2"W (1200 mm) Cabinet
32830-708	32830-E08	For 48.0"W (1220 mm) Cabinet
<b>Cabinet Supported Exhaust Duct Horizontal Support Beam</b>		
32820-701	32820-E01	Adjusts from 48"W (1200 mm) to 8"W (2159 mm)
<b>Cabinet Supported Exhaust Duct End Panel Kit</b>		
32850-701	32850-E01	Adjusts from 48"W (1200 mm) to 59"W (1499 mm)
32850-702	32850-E02	Adjusts from 59"W (1499mm) to 70"W (1778 mm)
32850-703	32850-E03	Adjusts from 70"W (1778 mm) to 81"W (2057 mm)

## HAC Ordering Information

### Adjustable Filler Panel

Fills gaps below the Cabinet Supported Exhaust Duct Panels (P/N 32830) when cabinets vary in height. Includes vertical and horizontal seals. Adjusts in height and is available for 6U and 9U cabinet height differences.

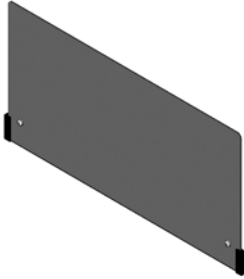

32835-000

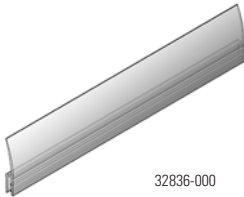

32836-000

Part Number & Finish		Description
Black	Glacier White	
<b>Adjustable Filler Panel</b>		
<b>For up to 6U High Cabinet Height Difference</b>		
32825-700	32825-E00	For a 23.6"W (600 mm) Cabinet
32825-702	32825-E02	For a 24"W (610 mm) Cabinet
32825-704	32825-E04	For a 27.6"W (700 mm) Cabinet
32825-706	32825-E06	For a 29.5"W (750 mm) Cabinet
32825-708	32825-E08	For a 31.5"W (800 mm) Cabinet
<b>For up to 9U High Cabinet Height Difference</b>		
32825-701	32825-E01	For a 23.6"W (600 mm) Cabinet
32825-703	32825-E03	For a 24"W (610 mm) Cabinet
32825-705	32825-E05	For a 27.6"W (700 mm) Cabinet
32825-707	32825-E07	For a 29.5"W (750 mm) Cabinet
32825-709	32825-E09	For a 31.5"W (800 mm) Cabinet

### Cabinet Supported Exhaust Duct H-Seal & Exhaust Duct Edge Seal

Use H-Seal to splice and seal the gap between the translucent duct panels on adjacent duct panel kits. Use Duct Edge Seal at the top to seal the space between the duct and the drop ceiling.

Cabinet Supported Exhaust Duct H-Seal		
Part Number & Quantity		Description
2 Pack	10 Pack	
32835-000	32835-001	4'L (1.2 m), clear plastic
<b>Aisle Containment Exhaust Duct Edge Seal</b>		
2 Pack	6 Pack	Description
32836-000	32836-001	8'L (2.4 m), clear plastic

*Note: Order a 2 pack of H-Seal every other cabinet. Order sufficient Duct Edge Seal to surround the top perimeter of the duct.*



## Frame Supported Hot Aisle Containment (FS HAC) Solution

The Frame Supported Hot Aisle Containment (HAC) Solution features a frame supported exhaust duct that is used over a contained hot aisle as part of a closed hot air return. This solution integrates with perimeter cooling, provides immediate improved cooling efficiency and is compatible with economization methods. The duct is supported by the frame instead of the cabinets, allowing a mix of cabinets to be installed within the row. It is ideal for colocation facilities and large scale data centers that support cabinet-level equipment installation and changes.

- 1** Frame Supported Exhaust Duct – Cabinet-independent frame and translucent exhaust duct cover the contained aisle to capture and vent airflow out of the aisle. Used as part of a closed return for the air handling system.
- 2** Aisle Containment Exhaust Duct Edge Seal – Flexible, curved seal used around the top of the duct to create a complete seal with overhead drop ceiling tiles.
- 3** Aisle Containment Double Door Assembly – Sliding double doors with automatic closing features and large transparent panels. Attaches to the ends of the Frame Supported Exhaust Duct to seal the ends of the contained aisle (this system not compatible with Single Door Assembly).
- 4** Adjustable Height Filler Panel or Universal Cabinet End Panel – Adjustable height panels used above standard equipment cabinets to seal gaps between the 52U Frame Supported Exhaust Duct and the cabinets. Alternately, Universal Cabinet End Panels adjust in both height and width.
- 5** Full Height Blanking Panel – Translucent panel and seal used to fill gaps where entire cabinets are omitted from the cabinet row. Easy to trim to match required width. Supports “roll-in/roll-out” deployment, and variable length cabinet rows are created when cabinets of differing widths are deployed in the same row.
- 6** Aisle Containment Cabinet To Floor Seal Kit or AisleLok™ Under Rack Panel – Cabinet-specific trim panels used along the base of cabinets to seal the gap between the floor and the bottom of the cabinet frame. If not available from the cabinet manufacturer, trim and adhere AisleLok Under Rack Panel to seal gaps under cabinets.

### Solution Overview

- Flexible frame supported duct installed before the cabinets allows you to add, remove or omit cabinets as required
- Compatible with virtually any mix of cabinets; any width and heights up to 52U high
- Large open spans with 12’ (3 m) to 20’ (6 m) clearance between frame support posts for bayed cabinets
- Built-in height, width and depth adjustments on frame beams, lateral supports and panels accommodate site differences and existing conditions, reducing the need for complex, time-consuming, field modification or special-ordered parts
- Translucent duct and transparent door panels allow light to enter the contained aisle
- Doors close automatically to maintain containment and reduce recovery time
- A complete solution maximizes performance with baffles to seal around and within the cabinets and contained aisle
- Durable construction and maintenance-free design provide

### Containment Accessory:

- Floor Mounting Template

# FRAME SUPPORTED HOT AISLE CONTAINMENT (HAC) SOLUTIONS

## FS HAC Ordering Information

The specific combination of components needed to create a complete Frame Supported Hot Aisle Containment (HAC) Solution will depend on a number of factors including room layout, ceiling height, whether there is a slab or raised access floor and what type of cabinet models are selected.

To ensure you have a complete solution that addresses site- and cabinet-specific requirements, please contact CPI Technical Support for assistance developing a Bill of Materials (BOM).

Based on your input, CPI Technical Support will propose a complete solution with a drawing and detailed BOM. They will take the time to explain each selection, so you have a complete understanding of how the CPI solutions will provide the desired results.

Example Bill Of Materials (BOM)			
Item	Part Number	Description	Qty
<b>Frame Supported Hot Aisle Containment (HAC) Solution</b>			
1	32990-E05	Frame Supported Exhaust Duct, For a 60"W (1524 mm) – 76.5"W (1943 mm) Aisle, 20'L (6.0 m), Glacier White	1
2	32836-001	Aisle Containment Edge Seal, 8'L (2.4 mm), Clear, 6 Pack	1
3	32770-E02	Aisle Containment Double Door Assembly, Glacier White with Anodized Door Frames	2
4	32728-E03	Adjustable Height Filler Panel, 9U, 23.6"W (600 mm), Glacier White	18
5	32995-E01	Full Height Blanking Panel, Glacier White	2
6	39208-E00	Cabinet To Floor Front Seal Kit, For 23.6"W (600 mm) F-Series TeraFrame Gen 3 Cabinet, Glacier White	18
	39209-E16	Cabinet To Floor Side Seal Kit, For 47.2"D (1200 mm) F-Series TeraFrame Gen 3 Cabinet frame, Glacier White	4
<b>Recommended Accessories</b>			
	32875-701	Installation Template, Aisle Containment Double Door Assembly	1
	FF1U-113C-E42-B	F-Series TeraFrame Cabinet, 45U, 23.6"W (600 mm) x 51.0"D (1297 mm), Perforated Doors, (2) Side Panels, Glacier White	18
	39085-E03	Air Dam Kit For F-Series TeraFrame Cabinets, 45U, 23.6"W (600 mm), Glacier White	18
	39132-E00	Bottom Panel For F-Series TeraFrame Gen 3 Cabinet, Glacier White	18
	34537-E02	Snap-In Filler Panel, 1U x 19"EIA, Glacier White, Pack of 50	2
	34538-E02	Snap-In Filler Panel, 2U x 19"EIA, Glacier White, Pack of 50	2
	13876-002	AisleLok Acrycell Sealing Tape, 2"W (50 mm), 8.5'L (2.6 m), Pack of 5	1
	13671-002	KoldLok Split Integral Raised Floor Grommet, Black, Pack of 10	2

For a more detailed analysis of your site, CPI offers a Pre-Installation Site Survey, a service where a CPI Technical Representative visits your site to provide a more detailed recommendation. To help ensure an optimized aisle containment installation, CPI offers On-Site Installation Supervision Services, which include related training and examination of the assembled solution. Both Pre-Installation Site Surveys and On-Site Installation Supervision Support are especially important if there are special conditions, concerns or required customization.

All suggestions and performance statements are based on using an overall approach to airflow containment through the use of CPI products and solutions. For more information about CPI's Aisle Containment services or products, call 800-834-4969, email techsupport@chatsworth.com or contact your Regional Sales Manager.

All products quoted are subject to availability based on manufacturing capacity, and shipping dates should be considered estimates only. While every effort has been made to ensure the accuracy of all information, CPI does not accept liability for any errors or omissions and reserves the right to change information and descriptions of listed services and products.

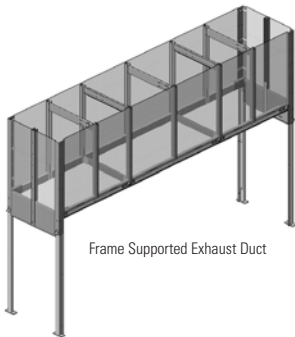

Frame Supported Exhaust Duct



Full Height Blanking Panel

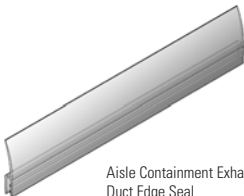

Aisle Containment Exhaust Duct Edge Seal

## FS HAC Ordering Information

### Frame Supported Exhaust Duct

Frame Supported Duct allows you to add, remove or omit cabinets as required. Captures and vents air from an aisle between adjacent rows of cabinets. Includes overhead duct and frame to support duct; order doors and filler panels separately. Compatible with any mix of cabinets and any width up to 52U high.

### Full Height Blanking Panel

Fills gaps when a cabinet is omitted from the aisle/cabinet row. Fits snugly and contains air in the enclosed hot aisle between the sides of adjacent rows. Center panel is translucent and sides are painted. Includes horizontal and vertical seals; order hardware separately.

### Frame Supported Exhaust Duct Edge Seal

Use Duct Edge Seal at the top to seal the space between the duct and the drop ceiling.

Part Number & Finish		Description
Black	Glacier White	
<b>Frame Supported Exhaust Duct</b>		
<b>For 60" (1524 mm) to 76.5" (1943 mm) Wide Frame</b>		
32990-701	32990-E01	12'L (3.6 m) Span/Cabinet Row
32990-702	32990-E02	14'L (4.2 m) Span/Cabinet Row
32990-703	32990-E03	16'L (4.8 m) Span/Cabinet Row
32990-704	32990-E04	18'L (5.4 m) Span/Cabinet Row
32990-705	32990-E05	20'L (6.0 m) Span/Cabinet Row
<b>Full Height Blanking Panel</b>		
32995-701	32995-E01	99.3"H (2522 mm) x 40"W (1016 mm), Each
32995-702	32995-E02	99.3"H (2522 mm) x 40"W (1016 mm), Pack of 6
<b>Frame Supported Exhaust Duct Edge Seal</b>		
<b>2 Pack</b>	<b>6 Pack</b>	<b>Description</b>
32836-000	32836-001	8'L (2.4 m), clear plastic

*Note: Frame Supported Exhaust Duct is available in other sizes.*

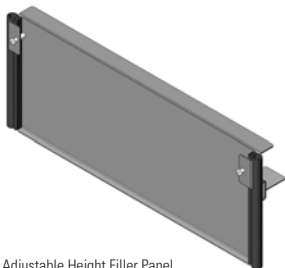

Adjustable Height Filler Panel

## FS HAC Ordering Information

### Adjustable Height Filler Panel

Use above short cabinets to fill gaps between the top of the cabinet and the Frame Supported Exhaust Duct. Adjusts height for 3U, 6U, 9U and 11U cabinet height differences.

### Universal Cabinet Panel

Alternative to Adjustable Height Filler Panel, except it adjusts in height and width. Available for 3U, 6U, 9U and 11U cabinet height differences.



Universal Cabinet End Panel

Part Number & Finish		Description
Black	Glacier White	
<b>Adjustable Height Filler Panel</b>		
<b>For up to 3U High Cabinet Height Difference*</b>		
32728-701	32728-E01	For 23.6"W (600 mm) Cabinets
32728-704	32728-E04	For 24"W (610 mm) Cabinets
32728-707	32728-E07	For 27.6"W (700 mm) Cabinets
32728-710	32728-E10	For 29.5"W (750 mm) Cabinets
32728-713	32728-E13	For 31.5"W (800 mm) Cabinets
<b>Universal Cabinet Panel</b>		
<b>For up to 3U High Cabinet Height Difference*</b>		
32720-701	32720-E01	From 15.8"W (400 mm) to 23.6"W (600 mm)
32720-704	32720-E04	From 19.7"W (500 mm) to 27.6"W (700 mm)
32720-707	32720-E07	From 21.7"W (551 mm) to 29.5"W (750 mm)
32720-710	32720-E10	From 23.6"W (600 mm) to 31.5"W (800 mm)
32720-713	32720-E13	From 32.1"W (815 mm) 40.0"W (1016 mm)

*Note: Other sizes available.*





## Cabinet Supported Cold Aisle Containment (CAC) Solution

The Cabinet Supported Cold Aisle Containment (CAC) Solution features a cabinet supported ceiling that is used over a contained cold aisle as part of a closed cold air delivery system. This solution integrates with perimeter cooling and provides immediate improved cooling efficiency by separating hot and cold air within the room. It can be used as an alternative to hot aisle containment where there are low ceilings, or where it would be difficult to add an overhead drop ceiling. It is ideal for small or medium data centers or computer rooms that are adopting containment but need to minimize changes when retrofitting the site.

### Solution Overview

- Cabinet supported ceiling panel kit, ordered as a single part number
- Compatible with F-Series TeraFrame® Gen 3 Cabinets and GF-Series GlobalFrame® Gen 2 Cabinets
- Optional accessory filler panels accommodate shorter cabinets
- Translucent ceiling and transparent door panels allow light to enter the contained aisle
- Doors close automatically to maintain containment and reduce recovery time
- A complete solution maximizes performance with baffles to seal around and within the cabinets and contained aisle
- Durable construction and maintenance-free design provide many years of use

- 1** CPI Cabinet System – Create cabinet rows using F-Series Gen 3 TeraFrame® Cabinets or GF-Series GlobalFrame® Gen 2 Cabinets. Configure cabinets with Thermal Management Accessories that block airflow through and around cabinets.
- 2** Cabinet Supported Ceiling Panel Kit – Attaches to the tops of cabinets, forming a ceiling over the contained aisle. Ordered as a single part number to match aisle width and length.
- 3** Door Mounting Bracket Kit – Adjustable height brackets used to attach the Aisle Containment Door Assembly to the tops of cabinets.
- 4** Door Standoff Kit – Optional kit used when cabinets are placed over a raised floor to offset the door approximately 2.5" (64 mm) away from the side of cabinets so that the bottom of the door is not located over the edges of floor tiles.
- 5** Aisle Containment Door Assembly – Sliding double doors (shown) or single door, both with automatic closing feature and large transparent panel(s). Attaches to the ends of cabinets to seal the ends of the contained aisle.
- 6** Aisle Containment Cabinet To Floor Seal Kit – Cabinet-specific trim panels used along the base of cabinets to seal the gap between the floor and the bottom of the cabinet frame.

### Containment Accessory:

- Adjustable Height Filler Panel
- Universal Cabinet End Panel
- Door Top Seal Kit
- GlobalFrame Door Rail Support Kit
- Floor Mounting Template

# CABINET SUPPORTED COLD AISLE CONTAINMENT (CAC) SOLUTIONS

## CAC Ordering Information

The specific combination of components needed to create a complete Cabinet Supported Cold Aisle Containment (CAC) Solution will depend on a number of factors including room layout, ceiling height, whether there is a slab or raised access floor and what type of cabinet models are selected.

To ensure you have a complete solution that addresses site- and cabinet-specific requirements, please contact CPI Technical Support for assistance developing a Bill of Materials (BOM).

Based on your input, CPI Technical Support will propose a complete solution with a drawing and detailed BOM. They will take the time to explain each selection, so you have a complete understanding of how the CPI solutions will provide the desired results.

Example Bill Of Materials (BOM)			
Item	Part Number	Description	Qty
<b>Cabinet Supported CAC Aisle Containment (HAC) Solution</b>			
1	FF1U-113C-E42-B	F-Series TeraFrame Gen 3 Cabinet, 45U, 23.6"W (600 mm) x 47.2"D (1200 mm), Glacier White	20
2	32710-E75	Cabinet Supported Ceiling Panel Kit, 8"H (200 mm), 20'L (6.0 m), Glacier White	1
3	32805-E04	Door Mounting Bracket Kit, 5"H (125 mm), With Offset, Glacier White	2
4	32870-E01	Door Standoff Kit, For Double Door, Glacier White	2
5	32770-E02	Aisle Containment Double Door Assembly, Clear Doors, Glacier White	2
6	39208-E00	Cabinet To Floor Front Seal Kit, F-Series TeraFrame Gen 3, 23.6"W (600 mm)	20
	39209-E16	Cabinet To Floor Side Seal Kit, F-Series TeraFrame Gen 3, 47.2"D (1200 mm)	4
<b>Recommended Accessories</b>			
	32875-701	Installation Template, Aisle Containment Double Door Assembly	1
	39085-E03	Air Dam Kit For F-Series TeraFrame Gen 3 Cabinets, Glacier White	20
	39132-E00	Bottom Panel for F-Series TeraFrame Gen 3 Cabinet, Glacier White	20
	34537-E02	Snap-In Filler Panel, 1U x 19"EIA, 50 Pack, Glacier White	2
	34538-E02	Snap-In Filler Panel, 2U x 19"EIA, 50 Pack, Glacier White	2
	13761-002	KoldLok Split Integral Raised Floor Grommet, 10 Pack, Black	2

For a more detailed analysis of your site, CPI offers a Pre-Installation Site Survey, a service where a CPI Technical Representative visits your site to provide a more detailed recommendation. To help ensure an optimized aisle containment installation, CPI offers On-Site Installation Supervision Services, which include related training and examination of the assembled solution. Both Pre-Installation Site Surveys and On-Site Installation Supervision Support are especially important if there are special conditions, concerns or required customization.

All suggestions and performance statements are based on using an overall approach to airflow containment through the use of CPI products and solutions. For more information about CPI's Aisle Containment services or products, call 800-834-4969, email techsupport@chatsworth.com or contact your Regional Sales Manager.

All products quoted are subject to availability based on manufacturing capacity, and shipping dates should be considered estimates only. While every effort has been made to ensure the accuracy of all information, CPI does not accept liability for any errors or omissions and reserves the right to change information and descriptions of listed services and products.

# CABINET SUPPORTED COLD AISLE CONTAINMENT (CAC) SOLUTIONS

## CAC Ordering Information

### Cabinet Supported Ceiling Panel Kit

Encloses the top of an aisle between adjacent cabinet rows. Cabinet supported and fits snugly against the cabinet top panels. Large, translucent, full-width ceiling panels allow light to enter the contained aisle. Adjustable ends allow up to 8" (200 mm) of length adjustment, each end adjusts up to 4" (100 mm).



Cabinet Supported Ceiling Panel Kit

### Adjustable Height Filler Panel

Use above short cabinets to fill gaps between the top of the cabinet and the Ceiling Panel Kit. Adjust height for 3U, 6U, 9U and 11U cabinet height differences.



Adjustable Height Filler Panel

### Universal Cabinet Panel

Alternative to Adjustable Height Filler Panel except it adjusts in height and width. Available for 3U, 6U, 9U and 11U cabinet height differences.

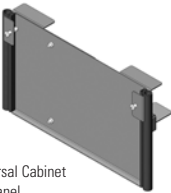

Universal Cabinet End Panel

Part Number & Finish		Description
Black	Glacier White	
<b>Cabinet Supported Ceiling Panel Kit</b>		
<b>For 2 Tile, 48"W (1200 mm) Aisles*</b>		
32710-712	32710-E12	4"H (100 mm), 20'L (6.0 m)
32710-775	32710-E75	8"H (200 mm), 20'L (6.0 m)
32710-7BW	32710-EBW	12"H (300 mm), 20'L (6.0 m)
<b>For 3 Tile, 72"W (1800 mm) Aisles*</b>		
32711-712	32711-E12	4"H (100 mm), 20'L (6.0 m)
32711-775	32711-E75	8"H (200 mm), 20'L (6.0 m)
32711-7BW	32711-EBW	12"H (300 mm), 20'L (6.0 m)
<b>Adjustable Height Filler Panel</b>		
<b>For up to 3U High Cabinet Height Difference*</b>		
32728-701	32728-E01	For 23.6"W (600 mm) Cabinets
32728-704	32728-E04	For 24"W (610 mm) Cabinets
32728-707	32728-E07	For 27.6"W (700 mm) Cabinets
32728-710	32728-E10	For 29.5"W (750 mm) Cabinets
32728-713	32728-E13	For 31.5"W (800 mm) Cabinets
<b>Universal Cabinet Panel</b>		
<b>For up to 3U High Cabinet Height Difference*</b>		
32720-701	32720-E01	From 15.8"W (400 mm) to 23.6"W (600 mm)
32720-704	32720-E04	From 19.7"W (500 mm) to 27.6"W (700 mm)
32720-707	32720-E07	From 21.7"W (551 mm) to 29.5"W (750 mm)
32720-710	32720-E10	From 23.6"W (600 mm) to 31.5"W (800 mm)
32720-713	32720-E13	From 32.1"W (815 mm) to 40.0"W (1016 mm)

Note: Other sizes available.

# CABLE MANAGEMENT PRODUCTS

Cable Managers & Accessories



Evolution® Cable Management

Velocity® Cable Management

Velocity® Standard Pack

Vertical Cable Management

Global Standard Pack

Horizontal Cable Management

Saf-T-Grip Straps

Cable Manager Accessories

Page 2-3

Page 2-8

Page 2-12

Page 2-13

Page 2-18

Page 2-28

Page 2-34

Page 2-35

# CABLE MANAGEMENT PRODUCTS

Connecting switches and servers with the right cabling is crucial to maximizing uptime, especially during system changes and updates. That is why it is important to keep your system organized with CPI Cable Management Products, end-to-end solutions that make it easier to identify, access and sort out all the cables and cords in your network. CPI's Cable Management Products help untangle any configuration and increase cable performance with systems that run within, between and around racks and cabinets. Rack-mount cable managers provide additional support for cable bundles by defining cable pathways, a critical step in achieving better cable organization.

To adapt to your data center needs, CPI Cable Management Products have been designed in a large variety of widths, heights and depths. They feature door panels to hide and secure cables and are available in several horizontal and vertical sections of various dimensions, utilizing rack-mount unit finger guides and/or rings.

## **CPI Cable Management Products feature:**

- High-quality construction and design
- Proper cable bend radii to ensure maximum performance of data transmission
- Decreased potential cable damage
- Easy cable moves, adds and changes
- Prevention of tangled cords

Patented

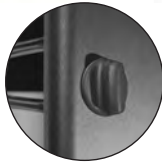
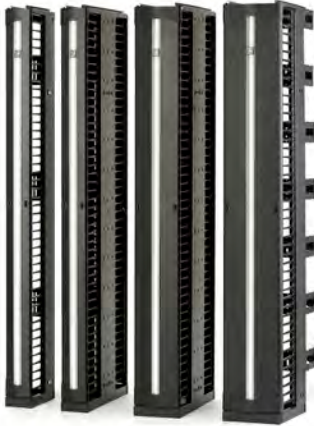

## Evolution® Cable Management

CPI Evolution® Cable Management provides an engineered solution for managing high-density cabling applications on open two-post and four-post CPI Rack Systems, delivering increased performance to match the demands of data center applications. Featuring easy-to-use doors with styling that complements the CPI TeraFrame® Family of Cabinets, Evolution Cable Management provides innovative interior features to help maximize the capacity and utility of vertical and horizontal cable management.

### Evolution Vertical Cable Manager:

Use vertical managers on the sides of racks to manage premise cables, patch cords and jumper cords. Vertical managers include plastic T-shaped cable guides with openings that align with each rack-mount unit space on the rack. Rounded edges on the cable guides and the top of the manager protect cables as they enter or exit the interior storage space. On double-sided managers, Movable Mid-Sections allow personalized placement of Cable Distribution Spools and other cable management accessories to effectively route patch cords. Use accessory Fiber Segregation Kits to create a dedicated internal channel for fiber cabling or accessory Cable Lashing Bar Kits to anchor premise cables closer to the Movable Mid-Sections to increase capacity. The Movable Mid-Sections can also be positioned for a 50/50, 40/60 or 60/40 front/rear split of the internal cable management space to match cabling requirements. The door is secured by a spring-loaded two-point latch controlled by a single knob; simply turn the knob on the right or left side of the door, and pull to swing the door open, or turn both knobs to remove the door. The door attaches to the base and top of the cable manager, not the cable guides, and opens wider than previous designs for better access to cables. Vertical managers are available in single-sided, double-sided and combination configurations in five widths to match cabling requirements.

### Features:

- Improved T-shaped cable guides decrease deflection when loaded with cables, especially important when deploying Cat 6a cable
- Rounded edges on the cable guides protect cables as they enter and exit the storage space
- Door opens to the right or left with a single knob
- Rigid trough minimizes movement when installed on the end of a row of racks; solid construction with a full rectangular base supports large bundles of heavy cables
- Openings in the back of the single-sided and middle of the double-sided managers allow cables to easily pass from front-to-rear
- Double-sided managers have Movable Mid-Sections that allow for flexibility in the volume of cable management space provided in the front and rear portions of the cable manager
- Various cable management accessories are available to divide the interior space and manage cable slack

Patented



Single-Sided Vertical Cable Manager also available in 6'H (1.8 m) and 8'H (2.4 m)

### Evolution g1 Single-Sided Vertical Cable Manager

- Rigid cable manager with 1U spaced plastic T-shaped cable guides (fingers)
- Three Fixed Accessory Panels at the back of the cable manager
- Three large Cable Distribution Spools included with 10", 12" and 15" (250 mm, 300 mm and 380 mm) wide managers

Part Number & Finish		7'H (2.1 m) W x D - in (mm)	Shipping Weight lb (kg)
Black	Glacier White		
35511-703	35511-E03	6 x 13.2 (150 x 335)	57 (25.9)
35512-703	35512-E03	8 x 13.2 (200 x 335)	61 (27.7)
35513-703	35513-E03	10 x 13.2 (250 x 335)	67 (30.4)
35514-703	35514-E03	12 x 13.2 (300 x 335)	73 (33.1)
35515-703	35515-E03	15 x 13.2 (380 x 335)	83 (37.6)

Patented



Double-Sided Vertical Cable Manager also available in 6'H (1.8 m) and 8'H (2.4 m)

### Evolution g2 Double-Sided Vertical Cable Manager

- Rigid cable manager with 1U spaced plastic T-shaped cable guides (fingers)
- Three Movable Mid-Sections; creates 50/50, 60/40 or 40/60 interior split
- Three large Cable Distribution Spools included with 10", 12" and 15" (250 mm, 300 mm and 380 mm) wide managers

Part Number & Finish		7'H (2.1 m) W x D - in (mm)	Shipping Weight lb (kg)
Black	Glacier White		
35521-703	35521-E03	6 x 24.5 (150 x 622)	94 (42.6)
35522-703	35522-E03	8 x 24.5 (200 x 622)	101 (45.8)
35523-703	35523-E03	10 x 24.5 (250 x 622)	110 (49.9)
35524-703	35524-E03	12 x 24.5 (300 x 622)	118 (53.5)
35525-703	35525-E03	15 x 24.5 (380 x 622)	129 (58.5)

Patented



Combination Vertical Cable Manager also available in 6'H (1.8 m) and 8'H (2.4 m)

### Evolution g3 Combination Vertical Cable Manager

- Rear Cable Rings with spin-open latches on back (no door/cover)
- Three large Cable Distribution Spools included with 10", 12" and 15" (250 mm, 300 mm and 380 mm) wide managers

Part Number & Finish		7'H (2.1 m) W x D - in (mm)	Shipping Weight lb (kg)
Black	Glacier White		
35571-703	35571-E03	6 x 20.2 (150 x 513)	68 (30.8)
35572-703	35572-E03	8 x 20.2 (150 x 513)	72 (32.7)
35573-703	35573-E03	10 x 20.2 (150 x 513)	78 (35.4)
35574-703	35574-E03	12 x 20.2 (150 x 513)	84 (38.1)
35575-703	35575-E03	15 x 20.2 (150 x 513)	94 (42.6)

Patented



35475-701

Patented



35473-001

Patented



35503-701

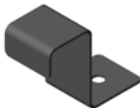

35506-701

## Evolution® Cable Management Accessories

### Fiber Segregation Kit

Creates a separate pathway for fiber cables and patch cords inside Evolution Vertical Managers. The number of kits allowed per manager depends on the position of the Movable Mid-Section in double-sided managers and the width of the vertical cable manager (see table below). Each kit includes two 20.5" H (521 mm) J-shaped steel mounting brackets, eight plastic Fiber Segregation Spools and mounting hardware. The Fiber Segregation Spools turn 360° with stops at 90°, allowing easy access to fiber cables. The assembled bracket is 3.8"W x 4.3"D (97 mm x 109 mm) and includes mounting hardware.

### Cable Lashing Bar Kit

Cable Lashing Bar Kit provides tie points for cables inside Evolution Vertical Managers. Use up to six cable lashing bars (front/rear) in 6"W (150 mm) vertical cable managers and up to ten (front/rear) in the 8"W (200 mm), 10"W (250 mm), 12"W (300 mm) and 15"W (380 mm) vertical cable managers. Each kit includes four round .23" (5.7 mm) diameter 20.6"L (524 mm) steel lashing bars and mounting hardware.

### Cable Divider Bar Kit

Provides tie points for cables inside the Evolution Vertical Cable Manager and divides the interior of the cable manager to create multiple pathways for cables. Each kit includes four Cable Divider Bars, 5.75"H x 1"W x 20"L (146 mm x 25 mm x 510 mm) and mounting hardware. Divider Bars are welded steel construction consisting of a vertical cable lashing bar and two U-shaped cable dividers. Use side-by-side to create multiple pathways in 10"W (250 mm) or wider cable managers.

### Floor Bracket

Floor Bracket secures the base of the Evolution Vertical Managers to the floor when located at the end of a row of equipment racks. Light-duty, steel bracket with attachment hole sized for 1/4" hardware; packs of 12, order separately.

Part Number	Description	Shipping Weight lb (kg)
35475-701	Fiber Segregation Kit, Black	6 (2.7)
35473-001	Cable Lashing Bar Kit, Zinc	2 (0.9)
35503-701	Cable Divider Bar Kit, Black	3 (1.4)
35506-701	Floor Bracket, Black	3 (1.4)

#### Maximum Number of Fiber Segregation Kits

Cable Manager Width in (mm)	Double-Sided with 60/40 Front/Rear Split (60% side)	Single-Sided and all other Double-Sided positions
6 (150)	1	0
8 (200)	1	1
10 (250)	2	1
12 (300)	2	2
15 (380)	2	2

See Cable Fill Tables at  
[www.chatsworth.com/cablefill](http://www.chatsworth.com/cablefill)



Patented



35501-X02

## Evolution® Cable Management Accessories

### Solid Rear Panel Manager

Encloses the rear of the Evolution g1 Single-Sided Vertical Cable Manager. Hangs from the top of the manager or attaches to the back of the Fixed Accessory Panels. Install Cable Distribution Spools and any additional Fixed Accessory Panels before attaching the Solid Rear Panel; does not block attachment of other accessories inside the manager. Sold individually or in pairs; includes hardware.

### Solid Mid Panel

Covers and divides the front and rear of the Evolution g2 Double-Sided Vertical Cable Manager. Easy installation; attaches to the back of the Movable Mid-Sections inside the manager. Does not block attachment of additional Movable Mid-Sections or other cable management accessories inside the manager. Includes one Moveable Mid-Section for 7'H (2.1m) manager and two for 8'H (1.8 m) manager. Sold individually or in packs of four; includes hardware.

### Solid Side Panel Manager

Covers the side of an Evolution g2 Double-Sided Vertical Cable Manager located at the end of a row of equipment racks. Easy tool-less installation; hangs from the top of the manager and attaches at the bottom of the manager with included snap-in hardware. Sold individually or in pairs.

Patented

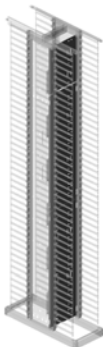

35497-X02

Patented



35502-X02

Part Number	Description Height - 7'H (2.1 m) Width - in (mm)	Shipping Weight lb (kg)
35501-X02	Solid Rear Panel, 6 (150), Each	11 (5.0)
35501-X05	Solid Rear Panel, 8 (200), Each	11 (5.0)
35501-X08	Solid Rear Panel, 10 (250), Each	11 (5.0)
35501-X11	Solid Rear Panel, 12 (300), Each	11 (5.0)
35501-X14	Solid Rear Panel, 15 (380), Each	11 (5.0)
35501-X52	Solid Rear Panel, 6 (150), Pair	42 (19.1)
35501-X55	Solid Rear Panel, 8 (200), Pair	42 (19.1)
35501-X58	Solid Rear Panel, 10 (250), Pair	42 (19.1)
35501-X61	Solid Rear Panel, 12 (300), Pair	42 (19.1)
35501-X64	Solid Rear Panel, 15 (380), Pair	42 (19.1)
35497-X02	Solid Mid Panel, 6 (150), Each	16 (7.3)
35497-X05	Solid Mid Panel, 8 (200), Each	16 (7.3)
35497-X08	Solid Mid Panel, 10 (250), Each,	16 (7.3)
35497-X11	Solid Mid Panel, 12 (300), Each	16 (7.3)
35497-X14	Solid Mid Panel, 15 (380), Each	16 (7.3)
35497-X52	Solid Mid Panel, 6 (150), Pack of 4	62 (28.1)
35497-X55	Solid Mid Panel, 8 (200), Pack of 4	62 (28.1)
35497-X58	Solid Mid Panel, 10 (250), Pack of 4	62 (28.1)
35497-X61	Solid Mid Panel, 12 (300), Pack of 4	62 (28.1)
35497-X64	Solid Mid Panel, 15 (380) Pack of 4	62 (28.1)
35502-X02	Solid Side Panel Manager, Each	19 (8.6)
35502-X52	Solid Side Panel Manager, Pair	35 (15.9)

Accessories listed on this page are also available in both 6' (1.8) and 8' (2.4) heights.

X=color; 7=Black, E=Glacier White.

Patented



35492-X02

Patented



35493-X02



15008-001



35505-001

## Evolution® Cable Management Accessories

### Fixed Accessory Panel Kit for Evolution g1 Single-Sided Manager

Kit includes three Fixed Accessory Panels for the Evolution g1 Single-Sided Vertical Cable Manager. Select to match the width of the cable manager; includes installation hardware.

### Movable Mid-Section Kit for Evolution g2 Double-Sided Manager

Kit includes three Movable Mid-Sections for the Evolution g2 Double-Sided Vertical Cable Manager. Select to match the width; includes installation hardware.

### Cable Distribution Spools

Spools provide slack management and strain relief for patch cords and jumper cables inside Evolution Vertical Cable Managers. Three large cable distribution spools are included with each 10", 12" and 15" wide (250 mm, 300 mm and 380 mm) vertical cable manager (will not fit other sizes). Attaches inside vertical cable managers. Spools are 2.75" (69.9 mm) in diameter and 5.9"L (150 mm) and made from black plastic; each kit includes four spools and mounting hardware.

### Cable Distribution Spool Spacer Kit

Spool Spacer Kit is used to offset the spool, so the front edge of the spool is close to the front edge of cable management fingers in the Evolution g2 Double-Sided Cable Managers. Use in 10", 12" and 15"W (250 mm, 300 mm and 380 mm) managers; includes three spools and three spacers. Attaches to the Movable Mid-Sections. Use one Cable Distribution Spool Spacer with each Cable Distribution Spool when the Movable Mid-Sections in the cable manager are set for a 50/50 front/rear split. Use two Cable Distribution Spool Spacers with each Cable Distribution Spool when the Movable Mid-Sections in the cable manager are set for a 60/40 front/rear split; stack both of the Cable Distribution Spool Spacers on the 60% side. Spacers are 2.8" (71 mm) in diameter, 2.5"H (64 mm) and made from black plastic; each kit includes eight spacers and mounting hardware.

Part Number	Description Width - in (mm)	Shipping Weight lb (kg)
<b>Fixed Accessory Panel Kit</b>		
35492-X01	For 6 (150) Evolution g1 Single-Sided	3 (1.4)
35492-X02	For 8 (200) Evolution g1 Single-Sided	4 (1.8)
35492-X03	For 10 (250) Evolution g1 Single-Sided	5 (2.3)
35492-X04	For 12 (300) Evolution g1 Single-Sided	6 (2.7)
35492-X05	For 15 (380) Evolution g1 Single-Sided	7 (3.2)
<b>Movable Mid Section Kit</b>		
35493-X01	For 6 (150) Evolution g2 Double-Sided	4 (1.8)
35493-X02	For 8 (200) Evolution g2 Double-Sided	5 (2.3)
35493-X03	For 10 (250) Evolution g2 Double-Sided	5 (2.3)
35493-X04	For 12 (300) Evolution g2 Double-Sided	7 (3.2)
35493-X05	For 15 (380) Evolution g2 Double-Sided	8 (3.6)
15008-001	Cable Distribution Spools, Pack of 4, Black	2 (0.9)
35505-001	Cable Distribution Spool Spacer Kit, Black	1 (0.5)

X=color; 7=Black; E=Glacier White.

For Horizontal Evolution Cable Management, see Page 2-28.

Patent  
Pending



## Velocity® Cable Management

CPI's Velocity® Cable Management is an economical cable management solution for everyday use in telecommunication rooms, equipment rooms and lab spaces and creates a complete vertical and horizontal pathway for premise cabling and patch cords on CPI Rack Systems.

### Vertical Cable Managers:

Velocity Cable Management includes single- and double-sided vertical cable managers available in four widths and three heights. They can ship unassembled in compact packaging to reduce shipping costs and storage space, providing easier staging and handling on the job site with less packaging to remove. No tools are required to assemble the cable manager. The components simply snap together, and the manager bolts to the side of the rack with included hardware.

The vertical cable manager features a large cross section to maximize internal cable management space. To simplify cable management, T-shaped cable guides and openings on the sides of the manager align with each rack-mount unit and have rounded edges to protect cables from snags. Snap-on covers are included and swing open to the right or left to provide easy access, and protect cables when closed. The manager has openings in the body, which allow cables to easily pass from front-to-rear. Add the accessory Cable Spool Kit to manage fiber, the Cable Lashing Bar Kit to secure large cable bundles or the Cable Ring Kit to create a rear pathway on the back of single-sided managers.

- Vertical managers for open two-post and four-post CPI Rack Systems that have 3" D (80 mm) mounting channels; do not use with 6" Deep Standard Rack or SeismicFrame Two-Post Rack
- Packaging:
  - Each vertical cable manager ships unassembled in a single carton
  - Each horizontal cable manager ships fully assembled in a single carton
- Material:
  - Vertical cable manager has steel mid panels, splice plates and plastic sides; covers on 3.6"W (91 mm) and 6"W (152 mm) managers are plastic; covers on 10"W (254 mm) and 12"W (305 mm) managers are steel with plastic hinges
  - Horizontal cable manager is plastic
- Finish: Black epoxy-polyester hybrid powder coat paint on steel parts; black plastic

Snaps together:

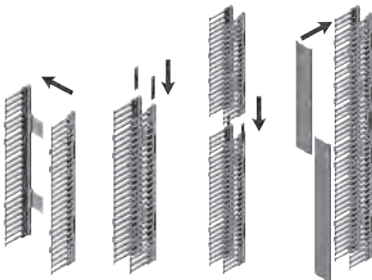



Note: 3.6"W & 6"W ship with extruded plastic doors; 10"W & 12"W ship with metal doors.

## Velocity® Single-Sided Vertical Cable Managers

### Single-Sided Vertical Cable Managers include:

- Four vertical side sections with T-shaped cable guides spaced 1U apart
- Four mid panels with attachment points for cable management accessories
- Two splice plates used to assemble the top and bottom side sections
- Two half-height covers that snap onto the T-shaped cable guides
- Eight M8 hex bolts, washers and hex flange nuts to secure cable managers to the rack

Velocity Single-Sided Vertical Cable Managers		
Part Number	Description H x W x D in (mm)	Shipping Weight lb (kg)
<b>For 6'H (1.8 m), 38U Racks</b>		
13901-701	70 x 3.6 x 9.7 (1778 x 91 x 246)	17 (7.7)
13902-701	70 x 6 x 9.8 (1778 x 152 x 249)	18 (8.2)
13904-701	70 x 10 x 10.3 (1778 x 254 x 262)	30 (13.6)
13905-701	70 x 12 x 10.4 (1778 x 305 x 264)	32 (14.5)
<b>For 7'H (2.1 m), 45U Racks</b>		
13901-703	80.5 x 3.6 x 9.7 (2045 x 91 x 246)	18 (8.2)
13902-703	80.5 x 6 x 9.8 (2045 x 152 x 249)	20 (9.1)
13904-703	80.5 x 10 x 10.3 (2045 x 254 x 262)	32 (14.5)
13905-703	80.5 x 12 x 10.4 (2045 x 305 x 264)	34 (15.4)
<b>For 8'H (2.4 m), 51U/52U Racks</b>		
13901-715	91 x 3.6 x 9.7 (2311 x 91 x 246)	19 (8.6)
13902-715	91 x 6 x 9.8 (2311 x 152 x 249)	21 (9.5)
13904-715	91 x 10 x 10.3 (2311 x 254 x 262)	34 (15.4)
13905-715	91 x 12 x 10.4 (2311 x 305 x 264)	36 (16.3)

Color is black. Velocity Single-Sided Vertical Cable Managers are 9.5"D (241 mm) without doors. The overall depth listed in the order table varies due to the bevel on the door, which differs slightly with width. Usable depth is 7.5" (191 mm). Usable width is 1.3" (33 mm) less than overall width.



Velocity® Cable Managers are easy to ship and store - compact packaging requires less storage space, reduces waste and is easier and more cost-efficient to ship.



Note: 3.6"W & 6"W ship with extruded plastic doors; 10"W & 12"W ship with metal doors.

## Velocity® Double-Sided Vertical Cable Manager

### Double-Sided Vertical Cable Manager includes:

- Four vertical side sections with T-shaped cable guides spaced 1U apart
- Four mid panels with attachment points for cable management accessories
- Two splice plates used to assemble the top and bottom side sections
- Four half-height covers that snap onto the T-shaped cable guides
- Eight M8 hex bolts, washers and hex flange nuts to secure cable managers to the rack

Velocity Double-Sided Vertical Cable Managers		
Part Number	Description H x W x D in (mm)	Shipping Weight lb (kg)
<b>For 6"H (1.8 m), 38U Racks</b>		
13911-701	70 x 3.6 x 16.4 (1778 x 91 x 417)	23 (10.4)
13912-701	70 x 6 x 16.6 (1778 x 152 x 422)	26 (11.8)
13914-701	70 x 10 x 17.5 (1778 x 254 x 445)	37 (16.8)
13915-701	70 x 12 x 17.8 (1778 x 305 x 446)	40 (18.1)
<b>For 7"H (2.1 m), 45U Racks</b>		
13911-703	80.5 x 3.6 x 16.4 (2045 x 91 x 417)	25 (11.3)
13912-703	80.5 x 6 x 16.6 (2045 x 152 x 422)	28 (12.7)
13914-703	80.5 x 10 x 17.5 ( 2045 x 254 x 445)	40 (18.1)
13915-703	80.5 x 12 x 17.8 (2045 x 305 x 446)	43 (19.5)
<b>For 8"H (2.4 m), 51U/52U Racks</b>		
13911-715	91 x 3.6 x 16.4 (2311 x 91 x 417)	27 (12.2)
13912-715	91 x 6 x 16.6 (2311 x 152 x 422)	30 (13.6)
13914-715	91 x 10 x 17.5 (2311 x 254 x 445)	44 (20.0)
13915-715	91 x 12 x 17.8 (2311 x 305 x 464)	47 (21.3)

Color is black. Velocity Double-Sided Vertical Cable Managers are 16 "D (406 mm) without doors. The overall depth listed in the order table varies due to the bevel on the door, which differs slightly with width. Usable depth in the front of the manager is 7.5" (191 mm). Usable depth at the rear of the manager is 5.5" (140 mm). Usable width is 1.3" (33 mm) less than overall width.

## Velocity® Cable Management Accessories

### Cable Ring Kit

Creates a separate cable pathway on the back of a Velocity Single-Sided Vertical Cable Manager for premise cables. Attaches to the sides with included hardware. Match the kit to the width and height of the vertical cable managers; one kit per manager. Rings are C-shaped, 3.0"H x 7.7"D (76 mm x 196 mm), made from aluminum and painted black; latch is black plastic and spins open to provide access to cables. Cable opening on 3.6"W (91 mm) rings is 1.4"W (36 mm); cable opening on other rings is 3.8"W (97 mm). Each kit includes multiple rings and mounting hardware. The kit for 6' (1.8 m) includes six rings, the kit for 7' (2.1 m) includes seven rings, and the kit for the 8' (2.4 m) includes eight rings.



13934-7XX



13935-701

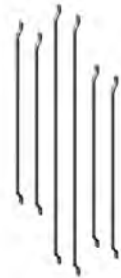

13928-001

### Cable Spool Kit

The Cable Spool Kit includes four small cable spools to provide slack management and strain relief for patch cords and jumper cables inside the Velocity Vertical Cable Managers. Attaches to the mid panel with included hardware. Use in 6"W (152 mm) or wider vertical cable managers; one kit per side. Spools are 2" (51 mm) in diameter and 6"L (152 mm) and made from aluminum; painted black. Each kit includes four spools and mounting hardware.

### Cable Lashing Bar Kit

Provides tie points for cables inside Velocity Vertical Cable Managers. Attaches to the mid panel with included hardware. Use in 6"W (152 mm) or wider vertical cable managers; one kit per side. Bars are .23" (5.7 mm) in diameter; two bars are 23.7"L (602 mm), four bars are 16.6"L (422 mm), and they are made from steel, zinc-plated and silver-colored. Each kit includes six lashing bars and mounting hardware.

Part Number	Description H x W ft (m) x in (mm)	Shipping Weight lb (kg)
13934-716	Cable Ring Kit for 6 (1.8) x 3.6 (91) Manager	8 (3.6)
13934-717	Cable Ring Kit for 7 (2.1) x 3.6 (91) Manager	9 (4.1)
13934-718	Cable Ring Kit for 8 (2.4) x 3.6 (91) Manager	11 (5.0)
13934-726	Cable Ring Kit for 6 (1.8) x 6 (152) Manager	9 (4.1)
13934-727	Cable Ring Kit for 7 (2.1) x 6 (152) Manager	11 (5.0)
13934-728	Cable Ring Kit for 8 (2.4) x 6 (152) Manager	12 (5.4)
13934-746	Cable Ring Kit for 6 (1.8) x 10 (254) Manager	12 (5.4)
13934-747	Cable Ring Kit for 7 (2.1) x 10 (254) Manager	14 (6.4)
13934-748	Cable Ring Kit for 8 (2.4) x 10 (254) Manager	15 (6.8)
13934-756	Cable Ring Kit for 6 (1.8) x 12 (305) Manager	14 (6.4)
13934-757	Cable Ring Kit for 7 (2.1) x 12 (305) Manager	16 (7.3)
13934-758	Cable Ring Kit for 8 (2.4) x 12 (305) Manager	18 (8.2)
13935-701	Cable Spool Kit, Pack of 4, Black	2 (0.9)
13928-001	Cable Lashing Bar Kit, Zinc	2 (0.9)

*Cable Ring Kits are Black.*



## Velocity® Standard Pack

The Velocity® Standard Pack is an easy-to-use solution for managing equipment and cabling at the cross connect. It includes one CPI Standard Rack, a concrete floor installation kit and a single or double-sided Velocity vertical cable manager packaged in a single carton.

The Velocity Standard Pack is offered in four variations, with a single-sided or double-sided cable manager in either 3.6" W (91 mm) or 6" W (152 mm). Cable managers can be mounted on either side of the standard rack.

- Numbered rack-mount spaces on the Standard Rack are printed on the equipment mounting channels, providing the installer an easy way of positioning equipment in planned spaces
- Cable openings in Velocity Vertical Cable Managers align with rack-mount units on the rack, allowing cables to exit by rack-mount units
- Integrated masked grounding studs on the inside of the rack channel for quick attachment to the Telecommunications Grounding System
- Cable openings have rounded edges to protect cable and will not deform or break
- Cover snaps on and opens to the right or left for easy access to cables during moves, adds or changes

### Velocity Standard Pack includes:

- (1) 45U x 19" Standard Rack
- (1) Single or double-sided Velocity® vertical cable manager
- (1) Rack installation kit



Rack-Mount Unit (U) marks simplify equipment installation



Ground Studs located directly on rack channel



Side cable openings align with rack-mount units on the rack

Part Number	Description Width in (mm)	Shipping Weight lb (kg)
57011-703	(1) Standard Rack, 45U x 19"EIA, UL, Black (1) Velocity® Single-Sided Vertical Cable Manager, 3.6"W (91 mm), Black (1) Rack Installation Kit for concrete floor, 1/2" hardware, Zinc	47 (21.3)
57012-703	(1) Standard Rack, 45U x 19"EIA, UL, Black (1) Velocity® Double-Sided Vertical Cable Manager, 3.6"W (91 mm), Black (1) Rack Installation Kit for concrete floor, 1/2" hardware, Zinc	60 (27.2)
57013-703	(1) Standard Rack, 45U x 19"EIA, UL, Black (1) Velocity® Single-Sided Vertical Cable Manager, 6"W (152 mm), Black (1) Rack Installation Kit for concrete floor, 1/2" hardware, Zinc	50 (22.7)
57014-703	(1) Standard Rack, 45U x 19"EIA, UL, Black (1) Velocity® Double-Sided Vertical Cable Manager, 6"W (152mm), Black (1) Rack Installation Kit for concrete floor, 1/2" hardware, Zinc	68 (30.8)

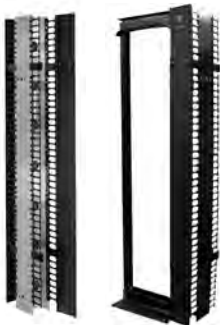

Double-Sided MCS shown with door open

Shown on rack with Jumper Tray

## MCS Master Cabling Section

The MCS Master Cabling Section virtually eliminates the need for horizontal cable managers by providing frequent 1U spacings of the cable guides that aligns precisely with the rack spacing.

Includes innovative, rigid aluminum SwitchGate Door/Cover that hides and conceals cable. A handle is included on the outside of the door/cover, making removal and installation even easier.

- Extra-wide, contoured cable guides provide smooth movement and meet UL 94V-0 Flame Resistant standards
- SwitchGate Door/Cover is easily switched from right to left opening and can be removed
- Double-Sided MCS Master Cabling Sections have edge-protected pass-through ports and vertical slots for optional Saf-T-Grip® straps
- 10"W (250 mm) version includes (4) Cable Distribution Spools
- Mounting hardware and doors are included
- Attach to Standard Racks, Universal Racks or QuadraRacks

Part Number	Height ft (m)	Depth in (mm)	Shipping Weight lb (kg)
<b>4.4"W (112 mm) Single-Sided</b>			
30091-X00	5.6 (1.7)	8.08 (205.2)	14 (6.4)
30091-X01	6 (1.8)	8.08 (205.2)	15 (6.8)
30091-X02	6.6 (2.0)	8.08 (205.2)	16 (7.3)
30091-X03	7 (2.1)	8.08 (205.2)	17 (7.7)
30091-X05	7.6 (2.3)	8.08 (205.2)	18 (8.2)
30091-X15	8 (2.4)	8.08 (205.2)	20 (9.1)
30091-X08	9 (2.7)	8.08 (205.2)	22 (10.0)
<b>6"W (150 mm) Single-Sided</b>			
30092-X00	5.6 (1.7)	8.08 (205.2)	16 (7.3)
30092-X01	6 (1.8)	8.08 (205.2)	17 (7.7)
30092-X02	6.6 (2.0)	8.08 (205.2)	19 (8.6)
30092-X03	7 (2.1)	8.08 (205.2)	20 (9.1)
30092-X05	7.6 (2.3)	8.08 (205.2)	21 (9.5)
30092-X15	8 (2.4)	8.08 (205.2)	23 (10.4)
30092-X08	9 (2.7)	8.08 (205.2)	25 (11.3)
<b>10"W (250 mm) Single-Sided</b>			
30093-X00	5.6 (1.7)	8.08 (205.2)	38 (17.2)
30093-X01	6 (1.8)	8.08 (205.2)	40 (18.1)
30093-X02	6.6 (2.0)	8.08 (205.2)	43 (19.5)
30093-X03	7 (2.1)	8.08 (205.2)	45 (20.4)
30093-X05	7.6 (2.3)	8.08 (205.2)	48 (21.8)
30093-X15	8 (2.4)	8.08 (205.2)	51 (23.1)
30093-X08	9 (2.7)	8.08 (205.2)	56 (25.4)

Part Number	Height ft (m)	Depth in (mm)	Shipping Weight lb (kg)
<b>4.4"W (112 mm) Double-Sided</b>			
30094-X00	5.6 (1.7)	16.15 (410.2)	34 (15.4)
30094-X01	6 (1.8)	16.15 (410.2)	36 (16.3)
30094-X02	6.6 (2.0)	16.15 (410.2)	38 (17.2)
30094-X03	7 (2.1)	16.15 (410.2)	40 (18.1)
30094-X05	7.6 (2.3)	16.15 (410.2)	42 (19.1)
30094-X15	8 (2.4)	16.15 (410.2)	45 (20.4)
30094-X08	9 (2.7)	16.15 (410.2)	49 (22.2)
<b>6"W (150 mm) Double-Sided</b>			
30095-X00	5.6 (1.7)	16.15 (410.2)	38 (17.2)
30095-X01	6 (1.8)	16.15 (410.2)	40 (18.1)
30095-X02	6.6 (2.0)	16.15 (410.2)	43 (19.5)
30095-X03	7 (2.1)	16.15 (410.2)	45 (20.4)
30095-X05	7.6 (2.3)	16.15 (410.2)	48 (21.8)
30095-X15	8 (2.4)	16.15 (410.2)	51 (23.1)
30095-X08	9 (2.7)	16.15 (410.2)	56 (25.4)
<b>10"W (250 mm) Double-Sided</b>			
30096-X00	5.6 (1.7)	16.15 (410.2)	44 (20.0)
30096-X01	6 (1.8)	16.15 (410.2)	47 (21.3)
30096-X02	6.6 (2.0)	16.15 (410.2)	50 (22.7)
30096-X03	7 (2.1)	16.15 (410.2)	53 (24.0)
30096-X05	7.6 (2.3)	16.15 (410.2)	57 (25.9)
30096-X15	8 (2.4)	16.15 (410.2)	60 (27.2)
30096-X08	9 (2.7)	16.15 (410.2)	67 (30.4)

X=Color, 5=Clear, 7=Black, E=Glacier White. Clear (-5XX) versions have black doors/covers and cable guides.  
 9' (2.7 m) unit is an 8' (2.4 m) unit with 1' (0.3 m) extension.



## MCS-EFX Master Cabling Section With Extended Fingers

The MCS-EFX is a larger, higher capacity version of CPI's popular MCS Master Cabling Section vertical cable management solution. It is appropriate for two-post and four-post applications and is available in single-sided and double-sided configurations.

MCS-EFX is manufactured from a combination of strong, lightweight aluminum sheet and plenum-rated composite materials for maximum strength at minimal weight. MCS-EFX is packaged in a single carton for easy handling and includes installation hardware.

- Cable openings on the side of MCS-EFX are sized to accommodate 48 patch cords, twice the capacity of the standard MCS; openings have rounded edges to protect cable and will not deform or break
- Patented cable openings on the sides of MCS-EFX align with rack-mount unit space on the rack, allowing cables to exit by rack-mount unit
- The door hinges open to the right or left for easy access to cables during moves, adds and changes and locks in the closed position to protect cables from damage
- Plastic Cable Guides meet UL 94V-0 Flame Resistant standards
- 10"W and 12"W (250 mm and 300 mm) Double-Sided MCS-EFX include (4) Cable Distribution Spools
- Mounting hardware and doors are included
- Attach to Standard Racks, Universal Racks or QuadraRacks



Extended fingers of MCS-EFX



Hinged locking door

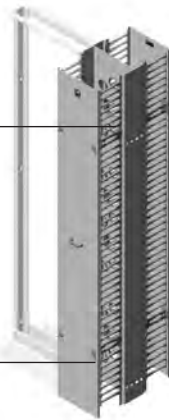

Part Number	Height ft (m)	Depth in (mm)	Shipping Weight lb (kg)
<b>6"W (150 mm) Single-Sided</b>			
40092-X03	7 (2.1)	10.62 (269.7)	31 (14.1)
40092-X05	7.6 (2.3)	10.62 (269.7)	32 (14.5)
40092-X15	8 (2.4)	10.62 (269.7)	35 (15.9)
<b>10"W (250 mm) Single-Sided</b>			
40093-X03	7 (2.1)	10.62 (269.7)	40 (18.1)
40093-X05	7.6 (2.3)	10.62 (269.7)	42 (19.1)
40093-X15	8 (2.4)	10.62 (269.7)	45 (20.4)
<b>12"W (300 mm) Single-Sided</b>			
40094-X03	7 (2.1)	10.62 (269.7)	44 (20.0)
40094-X05	7.6 (2.3)	10.62 (269.7)	47 (21.3)
40094-X15	8 (2.4)	10.62 (269.7)	50 (22.7)

Part Number	Height ft (m)	Depth in (mm)	Shipping Weight lb (kg)
<b>6"W (150 mm) Double-Sided</b>			
40095-X03	7 (2.1)	21.23 (539.2)	56 (25.4)
40095-X05	7.6 (2.3)	21.23 (539.2)	59 (26.8)
40095-X15	8 (2.4)	21.23 (539.2)	62 (28.1)
<b>10"W (250 mm) Double-Sided</b>			
40096-X03	7 (2.1)	21.23 (539.2)	69 (31.3)
40096-X05	7.6 (2.3)	21.23 (539.2)	73 (33.1)
40096-X15	8 (2.4)	21.23 (539.2)	76 (34.5)
<b>12"W (300 mm) Double-Sided</b>			
40097-X03	7 (2.1)	21.23 (539.2)	75 (34.0)
40097-X05	7.6 (2.3)	21.23 (539.2)	79 (35.8)
40097-X15	8 (2.4)	21.23 (539.2)	83 (37.6)

X=Color; 5=Clear; 7=Black; E=Glacier White. Clear (-5XX) versions have black doors/covers and cable guides.

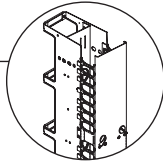

Hinged locking door

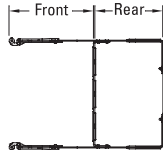

## CCS Combination Cabling Section

The CCS Combination Cabling Section offers the best of CPI's cabling sections, but with added design features. This cabling section is double-sided with the front side, featuring plastic cable guides (like those used on the MCS Master Cabling Section,) while the back retains the classic VCS Vertical Cabling Section design.

- 1U cable guides on the front designed for fanning and managing patch cords
- Open cabling section on the rear provides easy access and routes cable bundles feeding into the back of patch panels
- Edge-protected pass-through ports make it easy to route cable from front-to-back; vertical slots along the center separator neatly secure cable bundles with optional Saf-T-Grip® Cable Management Straps
- Plastic Cable Guides meet UL 94V-0 Flame Resistant standards
- Innovative SwitchGate Door/Cover (front) is easily opened from the right or left and can be removed so that cable does not have to thread through guides
- Attach to Standard Racks, Universal Racks, QuadraRack or Adjustable QuadraRack frames
- Mounting hardware and doors are included

### Usable Depth

For 3"D (80 mm) Rack Version:

Front=5.90" (149.9 mm); Rear=5.35" (135.9 mm)

For 6"D (150 mm) Rack Version:

Front=7.40" (188.0 mm); Rear=6.85" (174.0 mm)

Part Number 3"D (80 mm) Racks	Height ft (m)	Depth in (mm)	Shipping Weight lb (kg)
<b>3.65"W (92.7 mm)</b>			
30161-X01	6 (1.8)	12.24 (311)	25 (11.3)
30161-X03	7 (2.1)	12.24 (311)	29 (13.2)
30161-X05	7.6 (2.3)	12.24 (311)	31 (14.1)
30161-X15	8 (2.4)	12.24 (311)	33 (15.0)
30161-X08	9 (2.7)	12.24 (311)	38 (17.2)
<b>6"W (150 mm)</b>			
30162-X01	6 (1.8)	12.24 (311)	29 (13.2)
30162-X03	7 (2.1)	12.24 (311)	34 (15.4)
30162-X05	7.6 (2.3)	12.24 (311)	37 (16.8)
30162-X15	8 (2.4)	12.24 (311)	39 (17.7)
30162-X08	9 (2.7)	12.24 (311)	44 (20.0)
<b>10"W (250 mm)</b>			
30163-X01	6 (1.8)	12.24 (311)	40 (18.1)
30163-X03	7 (2.1)	12.24 (311)	46 (20.9)
30163-X05	7.6 (2.3)	12.24 (311)	50 (22.7)
30163-X15	8 (2.4)	12.24 (311)	53 (24.0)
30163-X08	9 (2.7)	12.24 (311)	59 (26.8)

Part Number 6"D (150 mm) Racks	Height ft (m)	Depth in (mm)	Shipping Weight lb (kg)
<b>3.65"W (92.7 mm)</b>			
30164-X01	6 (1.8)	14.61 (371)	28 (12.7)
30164-X03	7 (2.1)	14.61 (371)	33 (15.0)
30164-X05	7.6 (2.3)	14.61 (371)	36 (16.3)
30164-X15	8 (2.4)	14.61 (371)	38 (17.2)
30164-X08	9 (2.7)	14.61 (371)	43 (19.5)
<b>6"W (150 mm)</b>			
30165-X01	6 (1.8)	14.61 (371)	33 (15.0)
30165-X03	7 (2.1)	14.61 (371)	38 (17.2)
30165-X05	7.6 (2.3)	14.61 (371)	41 (18.6)
30165-X15	8 (2.4)	14.61 (371)	44 (20.0)
30165-X08	9 (2.7)	14.61 (371)	49 (22.2)
<b>10"W (250 mm)</b>			
30166-X01	6 (1.8)	14.61 (371)	42 (19.1)
30166-X03	7 (2.1)	14.61 (371)	49 (22.2)
30166-X05	7.6 (2.3)	14.61 (371)	53 (24.0)
30166-X15	8 (2.4)	14.61 (371)	56 (25.4)
30166-X08	9 (2.7)	14.61 (371)	63 (28.6)

X=Color; 7=Black, E=Glacier White.

## CCS-EFX Combination Cabling Section With Extended Fingers

The CCS-EFX is a double-sided vertical cable management trough designed for use with most two- and four-post racks to manage cable at the cross connect, especially when using angled-face copper patch panels.

The CCS-EFX is manufactured from a combination of strong, lightweight aluminum sheet and plenum-rated composite materials for maximum strength at minimal weight. CCS-EFX is packaged in a single carton for easy handling and includes installation hardware.

- Cable openings on the front are sized to fit 48 patch cords, twice the capacity of the CCS; openings have rounded edges to protect cable and will not deform or break
- Cable openings on front of CCS-EFX align with rack-mount unit on rack, allowing cables to exit by rack-mount unit
- The front door hinges open to the right or left and locks in the closed position to protect cables
- Open cabling section on the rear of CCS-EFX allows large premise cable bundles to exit the manager into the rack-mount space. Spin closure latches secure cables
- Attach to 3"D (80 mm) Standard Racks, Universal Racks or QuadraRack
- Mounting hardware and doors are included



Extended fingers of CCS-EFX



Hinged locking door

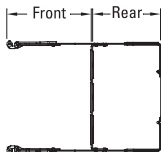

Usable Depth  
 Front=8.60" (218.4 mm);  
 Rear=5.35" (135.9 mm)

Part Number	Height ft (m)	Depth in (mm)	Shipping Weight lb (kg)
<b>6"W (150 mm)</b>			
40098-X03	7 (2.1)	14.94 (379.5)	38 (17.2)
40098-X05	7.6 (2.3)	14.94 (379.5)	41 (18.6)
40098-X15	8 (2.4)	14.94 (379.5)	44 (20.0)
<b>10"W (250 mm)</b>			
40099-X03	7 (2.1)	14.94 (379.5)	52 (23.6)
40099-X05	7.6 (2.3)	14.94 (379.5)	56 (25.4)
40099-X15	8 (2.4)	14.94 (379.5)	60 (27.2)
<b>12"W (300 mm)</b>			
40100-X03	7 (2.1)	14.94 (379.5)	56 (25.4)
40100-X05	7.6 (2.3)	14.94 (379.5)	60 (27.2)
40100-X15	8 (2.4)	14.94 (379.5)	64 (29.0)

X=Color, 7=Black, E=Glacier White.

## Global Vertical Cabling Section

The Global Vertical Cabling Section is an adaptable vertical cable management solution with a unique, two-piece design that reduces shipping size and cost. The two parts can be quickly assembled and then bolted to CPI's Universal and Standard racks, as well as QuadraRack and Adjustable QuadraRack frames. It ships partially assembled with patented cable guide fingers at 1U intervals. Each single-sided section includes a two-piece section, a two-piece door/cover and mounting hardware. Each double-sided section is a one-piece section and two-piece door/cover.

- Patented cable guide fingers at 1U intervals provide an organized pathway for cable and patch cords; 7"H (2.1 m) provides 45U
- Snap-on, hinged door/cover hides cable for a finished appearance, yet allows quick access to cable for making changes
- Door/cover swings on hinges to open left or right
- Acorn nuts eliminate sharp edges, reducing injuries and torn cables
- Seven 2.5" (64 mm) pass-through ports allow cables to transition front to back

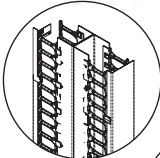

Double-Sided

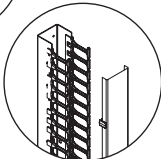

Single-Sided



Rings shown attached to GVCS



Part Number	Description	Shipping Weight lb (kg)
<b>Single-Sided GVCS</b>		
12830-X03	7"H x 3.65"W x 6.76"D, Narrow (2.1 m x 92.7 mm x 171.7 mm)	16 (7.3)
12832-X03	7"H x 3.65"W x 9.30"D, Narrow (2.1 m x 92.7 mm x 236.2 mm)	18 (8.2)
12831-X03	7"H x 6"W x 6.76"D, Wide (2.1 m x 150 mm x 171.7 mm)	19 (8.6)
12833-X03	7"H x 6"W x 9.30"D, Wide (2.1 m x 150 mm x 236.2 mm)	22 (10.0)
12834-X03	7"H x 10"W x 6.76"D, Wide (2.1 m x 250 mm x 171.7 mm)	26 (11.8)
12835-X03	7"H x 10"W x 9.30"D, Wide (2.1 m x 250 mm x 236.2 mm)	28 (12.7)
<b>Double-Sided GVCS</b>		
14830-X03	7"H x 3.65"W x 13.52"D, Narrow (2.1 m x 92.7 mm x 343.4 mm)	32 (14.5)
14831-X03	7"H x 6"W x 13.52"D, Wide (2.1 m x 150 mm x 343.4 mm)	39 (17.7)
14832-X03	7"H x 10"W x 13.52"D, Wide (2.1 m x 250 mm x 343.4 mm)	47 (21.3)

*X=*color: 5=Clear, 7=Black, E=Glacier White. Clear (-5XX) versions are only available in Double-Sided versions, and have black doors/covers and cable guides.

## Cable Rings For GVCS

Contains seven rings.

Part Number & Finish		Description	Shipping Weight lb (kg)
Black	Glacier White		
12836-701	12836-E01	3.65"W (92.7 mm) Rings	4 (1.8)
12836-702	12836-E02	6"W (150 mm) Rings	5 (2.3)
12836-703	12836-E03	10"W (250 mm) Rings	7 (3.2)

# VERTICAL CABLE MANAGEMENT



Standard Rack with RMU printed on rack



Fingers align with RMU on rack



Integrated masked ground studs

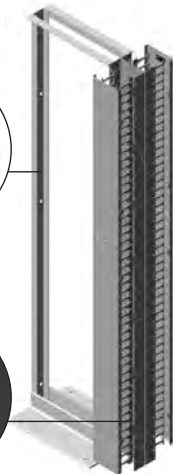

Combines a 7"H x 19"W x 3"D (2.1m x 19"W x 80 mm) Standard Rack, Global Vertical Cabling Sections and Concrete Floor Installation Kit into one convenient shipping container!

## Global Standard Pack

The Global Standard Pack shown has two Global Vertical Cabling Sections used back-to-back on the same side of the rack to create a double-sided cable manager. Cabling sections can also be mounted on opposite sides of the rack to create two single-sided cable pathways.

- Numbered rack-mount unit (U) spaces on the rack are printed on the equipment mounting channels, providing the installer an easy way of positioning equipment in planned spaces
- Cable openings in Global Vertical Cabling Section align with U on the rack, allowing cables to exit by U
- Integrated masked grounding studs on the inside of the rack channel for quick attachment to the Telecommunications Grounding System
- Cable openings have rounded edges to protect cable and will not deform or break
- Door/cover snaps on and opens to the right or left for easy access to cables during moves, adds or changes
- Global Standard Pack is UL Listed as a communication circuit accessory

Part Number	Description Width in (mm)	Shipping Weight lb (kg)
57001-X03	(1) Standard Rack, 45U x 19"EIA, UL (1) GVCS Single-Sided Vertical Cable Manager, 3.65"W (92.7 mm) (1) Rack Installation Kit for concrete floor, 1/2" hardware, Zinc	50 (22.7)
57002-X03	(1) Standard Rack, 45U x 19"EIA, UL (2) GVCS Single-Sided Vertical Cable Managers, 3.65"W (92.7 mm) (1) Rack Installation Kit for concrete floor, 1/2" hardware, Zinc	65 (29.5)
57003-X03	(1) Standard Rack, 45U x 19"EIA, UL (1) GVCS Single-Sided Vertical Cable Manager, 6"W (150 mm) (1) Rack Installation Kit for concrete floor, 1/2" hardware, Zinc	52 (23.6)
57004-X03	(1) Standard Rack, 45U x 19"EIA, UL (2) GVCS Single-Sided Vertical Cable Managers, 6"W (150 mm) (1) Rack Installation Kit for concrete floor, 1/2" hardware, Zinc	67 (30.4)

X=Color: 5=Clear, 7=Black, E=Glacier White. Clear (-5XX) versions include GVCS with black doors/covers and cable guides. GVCS is 6.76"D (171.7 mm).

## Single-Sided Narrow Vertical Cabling Section

Provides convenient cable run between equipment racks. Conceals cable for a more attractive installation.

- Bolts to CPI Standard Rack, Universal Rack, QuadraRack 4-Post Frame and QuadraRack Server Frame
- Includes formed cabling section, lockable cabling latches - 12" (300 mm) between latches, protective edge guards and mounting hardware
- 3.65"W x 6.38"D (92.7 mm x 162.1 mm); single-sided cable trough
- 9' (2.7 m) version consists of a 7' (2.1 m) section and 2' (0.6 m) extension

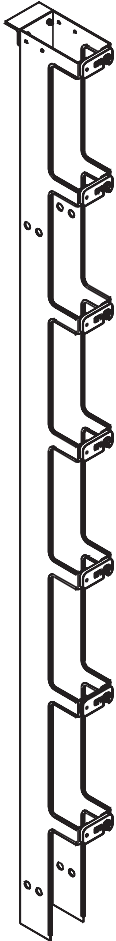

11730-X03  
Single-Sided Narrow

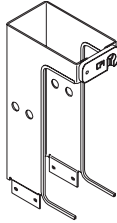

11584-X02  
One-Foot Extension

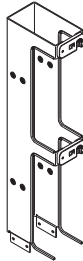

11378-X02  
Two-Foot Extension

### 11730 Cabling Section, Single-Sided, Narrow

#### Color

1	Gray
2	Computer Beige
5	Clear
7	Black
E	Glacier White

#### Height

00	5.6 (1.7)
01	6 (1.8)
02	6.6 (2.0)
03	7 (2.1)
05	7.6 (2.3)
15	8 (2.4)
08	9 (2.7)

11730	-	X	XX
-------	---	---	----

## Single-Sided Narrow Vertical Cabling Section Extensions

Adds one or two feet of height to vertical cabling sections, providing a uniform vertical pathway from ceiling to rack. Mounting hardware included.

Part Number	Description W x D in (mm)	Shipping Weight lb (kg)
11584-X02	One-Foot Extension 3.65 x 6.38 (92.7 x 162.1)	3 (1.4)
11378-X02	Two-Foot Extension 3.65 x 6.38 (92.7 x 162.1)	4 (1.8)

X=color: 1=Gray, 2=Computer Beige, 5=Clear, 7=Black, E=Glacier White.



11374-503  
Single-Sided Wide

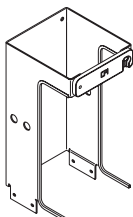

11584-X01  
One-Foot Extension

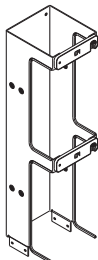

11378-X01  
Two-Foot Extension

## Single-Sided Wide Vertical Cabling Section

Provides convenient cable run between equipment racks. Conceals cable for a more attractive installation.

- Bolts to CPI Standard Rack, Universal Rack, QuadraRack® 4-Post Frame and QuadraRack Server Frame
- Includes formed cabling section, lockable cabling latches spaced 12" (300 mm) apart, protective edge guards and mounting hardware
- 6"W x 6.38"D (150 mm x 162.1 mm); single-sided cable trough
- 9' (2.7 m) version consists of 7' (2.1 m) section with a 2' (0.6 m) extension

### 11374 Cabling Section, Single-Sided, Wide

Color	
1	Gray
2	Computer Beige
5	Clear
7	Black
E	Glacier White

Height	
00	5.6 (1.7)
01	6 (1.8)
02	6.6 (2.0)
03	7 (2.1)
05	7.6 (2.3)
15	8 (2.4)
08	9 (2.7)

11374 - X XX

## Single-Sided Wide Vertical Cabling Section Extensions

Adds one or two feet of height to vertical cabling sections, providing a uniform vertical pathway from ceiling to rack. Mounting hardware included.

Part Number	Description W x D in (mm)	Shipping Weight lb (kg)
11584-X01	One-Foot Extension 6 x 6.38 (150 x 162.1)	3 (1.4)
11378-X01	Two-Foot Extension 6 x 6.38 (150 x 162.1)	4 (1.8)

X=Color: 1=Gray, 2=Computer Beige, 5=Clear, 7=Black, E=Glacier White.

## Double-Sided Narrow Vertical Cabling Section

Provides double-sided 3.65" (92.7 mm) cable run between equipment racks. Oval ports measuring 1.38" x 2.25" (35.1 mm x 51.2 mm) are spaced at 11.62" (295.1 mm) intervals along center separator for convenient cable and wiring pass-through. Vertical slots secure optional Saf-T-Grip® Cable Management Straps for neatly bundled cables.

- Bolts to CPI Standard Rack, Universal Rack, QuadraRack 4-Post Frame and QuadraRack Server Frame
- Includes formed cabling section, lockable cabling latches spaced 12" (300 mm) apart, protective edge guards and mounting hardware
- 3.65"W x 12.75"D (92.7 mm x 323.9 mm); double-sided cable trough
- 1.38" x 2.25" (35.1 mm x 57.2 mm) oval pass-through ports every 11.62" (295.1 mm)
- 9' (2.7 m) version consists of 7' (2.1 m) section with a 2' (0.6 m) extension
- Mounting hardware included

Part Number	Description	Shipping Weight lb (kg)
12096-X03	7 (2.1) Double-Sided Narrow	24 (10.9)
12096-X15	8 (2.4) Double-Sided Narrow	27 (12.2)
12096-X08	9 (2.7) Double-Sided Narrow	28 (12.7)

X=color: 1=Gray, 2=Computer Beige, 5=Clear, 7=Black, E=Glacier White.

## Double-Sided Narrow Vertical Cabling Section Extensions

Adds one or two feet of height to vertical cabling sections, providing a uniform vertical pathway from ceiling to rack. Mounting hardware included.

Part Number	Description W x D in (mm)	Shipping Weight lb (kg)
11781-X02	One-Foot Extension 3.65 x 12.75 (92.7 x 323.9)	4 (1.8)
11782-X02	Two-Foot Extension 3.65 x 12.75 (92.7 x 323.9)	7 (3.2)

X=color: 1=Gray, 2=Computer Beige, 5=Clear, 7=Black, E=Glacier White

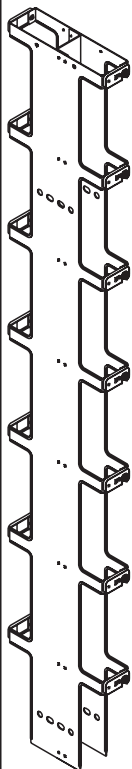

12096-X03  
Double-Sided Narrow

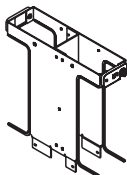

11781-X02  
One-Foot Extension

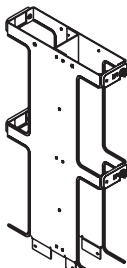

11782-X02  
Two-Foot Extension





11729-503  
Double-Sided Wide

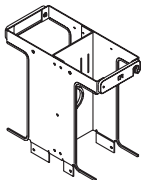

11781-X01  
One-Foot Extension

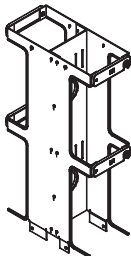

11782-X01  
Two-Foot Extension

## Double-Sided Wide Vertical Cabling Section

These space-saving ducts, with locking latches, hold and separate wiring for a more organized and managed equipment room installation. Provides convenient cable run between equipment racks. Conceals cable for a more attractive installation. 2.50" (63.5 mm) diameter ports spaced at 11.625" (295.28 mm) intervals allow for convenient cable and wiring pass-through. Vertical slots secure optional Saf-T-Grip® Cable Management Straps for neatly bundled cables.

- Bolts to CPI Standard Rack, Universal Rack, QuadraRack 4-Post Frame and QuadraRack Server Frame
- Includes formed cabling section, lockable cabling latches - 12" (300 mm) between latches, protective edge guards and mounting hardware
- 6"W x 12.75"D (150 mm x 323.9 mm); double-sided cable trough
- 2.5" (64.0 mm) diameter pass-through ports every 11.62" (295.1 mm)
- 9' (2.7 m) version consists of a 7' (2.1 m) section with a 2' (0.6 m) extension
- Mounting hardware included

Part Number	Description ft (m)	Shipping Weight lb (kg)
11729-X03	7 (2.1) Double-Sided Wide	30 (13.6)
11729-X15	8 (2.4) Double-Sided Wide	31 (14.1)
11729-X08	9 (2.7) Double-Sided Wide	32 (14.5)

X=color: 1=Gray, 2=Computer Beige, 5=Clear, 7=Black, E=Glacier White.

## Double-Sided Wide Vertical Cabling Section Extensions

Adds one or two feet of height to vertical cabling sections, providing a uniform vertical pathway from ceiling to rack. Mounting hardware included.

Part Number	Description W x D in (mm)	Shipping Weight lb (kg)
11781-X01	One-Foot Extension 6 x 12.75 (150 x 323.9)	5 (2.3)
11782-X01	Two-Foot Extension 6 x 12.75 (150 x 323.9)	9 (4.1)

X=color: 1=Gray, 2=Computer Beige, 5=Clear, 7=Black, E=Glacier White.

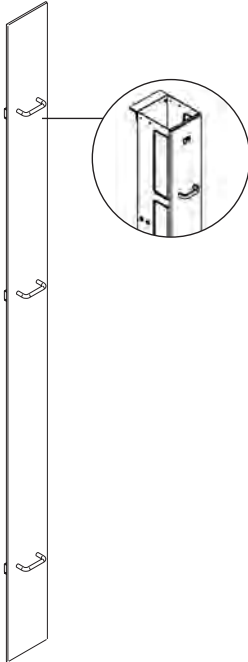

## Cabling Section Cover

Designed to be used on narrow and wide Vertical Cabling Sections to provide a clean, professional appearance. Available in metal or plexiglass versions; plexiglass for 7" (2.1 m) only; in sizes to fit your installation.

- Hides cables
- Provides professional appearance
- Quick attachment and removal
- For use with vertical cabling sections only

Part Number	Height ft (m)	Style	Shipping Weight lb (kg)
<b>3.65"W (92.7 mm)</b>			
12189-001	7 (2.1)	Plexiglass, Black	8 (3.6)
12664-X02	7 (2.1)	Metal	8 (3.6)
11923-X05	7.6 (2.3)	Metal	4 (1.8)
11923-X15	8 (2.4)	Metal	5 (2.3)
11923-X08	9 (2.7)	Metal	5 (2.3)
<b>6"W (150 mm)</b>			
12188-001	7 (2.1)	Plexiglass, Black	9 (4.1)
12664-X01	7 (2.1)	Metal	9 (4.1)
11922-X05	7.6 (2.3)	Metal	7 (3.2)
11922-X15	8 (2.4)	Metal	7 (3.2)
11922-X08	9 (2.7)	Metal	8 (3.6)

*X=color: 7=Black, E=Glacier White*

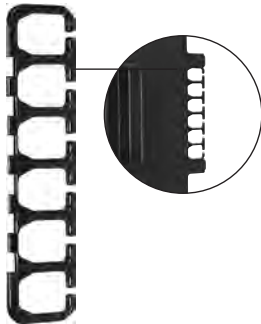

## Finger Snaps Cable Guides

Adding Finger Snaps Cable Guides is a snap. The unique, patented design provides retrofit cable guides in-between the latches on VCS Vertical Cabling Sections or CCS Combination Cabling Sections.

- Plastic cable guides that easily retrofit onto CPI VCS Vertical Cabling Sections or CCS Combination Cabling Sections
- Resilient composite material ensures long lasting, quality construction
- Extra-wide and contoured guides allow smooth transition of the cable from the horizontal pathway into a CPI cabling section
- 1U cable guides are designed for fanning and managing patch cords or cables
- Meets UL 94V-0 Flame Resistant standards

Part Number	Description	Shipping Weight lb (kg)
12370-001	2 Finger Snaps, Black	1 (0.5)
12370-002	12 Finger Snaps, Black	2 (0.9)

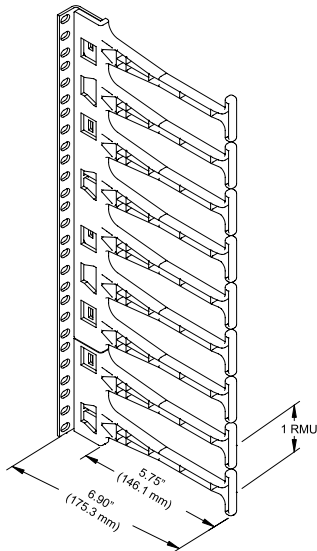

## Extended Fingers Bracket

Extended Fingers Bracket provides extra-deep cable management capacity for applications that require large cable bundles or thick cable.

Extra space also improves cable bend radius management, meeting or exceeding the needs of the latest Category 5e/6/6a or fiber industry standards. It is a cost-effective accessory for cable management in specific areas of the rack, rather than along its entire height.

- Preassembled in 7U, 9U and 13U heights for mounting directly onto any industry-standard rack
- Patented cable guide fingers at 1U intervals provide an organized cable pathway
- Made of durable, flame-retardant (UL 94V-0) plastic for environmental safety
- Sold individually

Part Number	Description	Shipping Weight lb (kg)
12891-X03	7U	2 (0.9)
12891-X01	9U	4 (1.8)
12891-X02	13U	4 (1.8)

X=color: 7=Black, E=Glacier White.

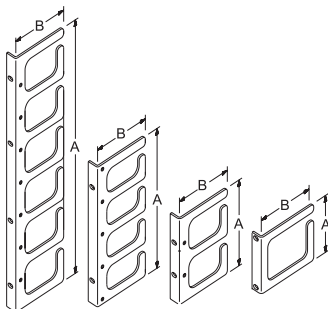

## Horizontal Cable Guides

Rack-Mounted Cable Guides organize multiple horizontal cable runs. Designed to use with most rack-mounted panels.

- Slotted loop design makes cable installation and changes quick and simple
- Made of thick aluminum and black plastic dipped to reduce cable insulation damage
- Sold in matching pairs
- Threaded side holes allow mounting of vertical cable loop (P/N 10683-001)

Part Number	Description	Dim. A in (mm)	Dim. B in (mm)
10419-001	One Loop	3.46 (87.9)	4.25 (108.0)
11157-001	Two Loop	5.25 (133.4)	3.88 (98.6)
11154-001	Four Loop	8.60 (218.4)	3.88 (98.6)
11153-001	Six Loop	15.60 (396.2)	3.88 (98.6)

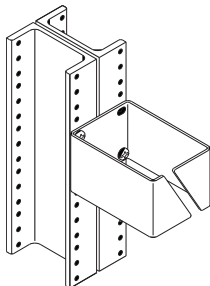
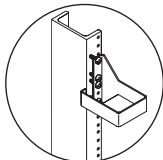
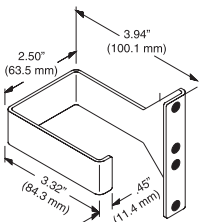
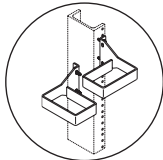
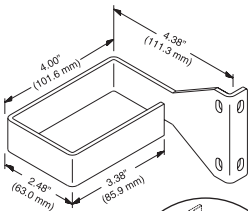

## IBM® Style Vertical Cable Loop

Used for vertical cable runs on most rack-mounted equipment. Mounts in a variety of ways to equipment rack or connector panels. 1-1/2" (38 mm) hole to hole.

- Aluminum construction coated with black plastic to prevent cable scrapes
- Sold individually or in package of 100
- Mounting hardware not included

Part Number	Color	Shipping Weight lb (kg)
10683-001	Black	1 (0.5)
10683-101	Black, Package of 100	23 (10.4)

## Vertical Wire Management Loop

CPI Vertical Wire Management Loop is used to organize patch cords and cabling. Maintains vertical wire management for one or two racks mounted together. Mounting hardware not included.

- Does not protrude into rack-mounting space
- Aluminum construction coated with black plastic to prevent damage to cable jackets

Part Number	Color	Shipping Weight lb (kg)
13079-001	Black	1 (0.5)

## Double-Wide Cable Ring

Provides vertical cable management space between racks butted side-by-side by mounting to the hole pattern across two rack channels. Large size, 2.3" H x 2.8" W x 4" D (58 mm x 71 mm x 100 mm), accommodates larger cable bundles. Made of thick aluminum with rounded edges to reduce cable insulation damage. Sold individually or in box of 100. Shipping weight approximately 4 oz (110 g) each and 25 lb (11.3 kg) for box of 100. Mounting hardware not included.

- Mounts to hole pattern across two rack channels
- Provides vertical cable management for larger cable bundles
- Use where vertical cabling section is not required

Part Number		Description
Individually	Box of 100	
12228-X01	12228-X11	Double-Wide Loop

X=color: 1=Gray, 2=Computer Beige, 5=Clear, 7=Black, E=Glacier White.

# VERTICAL CABLE MANAGEMENT

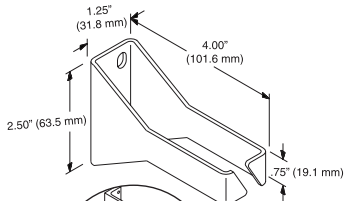

## Narrow Cable Ring

Attaches to walls or racks where width is limited. Holds and dresses vertical cable runs. Mounting hardware not included.

- Made of aluminum with rounded edges to reduce cable insulation damage
- Narrow Cable Ring is 2.50"H x 1.25"W x 4.00"D (63.5 mm x 31.8 mm x 101.6 mm)
- Sold individually or box of 100

Part Number		Description
Individually	Box of 100	
11228-X01	11228-X11	Narrow Cable Ring

X=color: 1=Gray, 2=Computer Beige, 5=Clear, 7=Black, E=Glacier White.

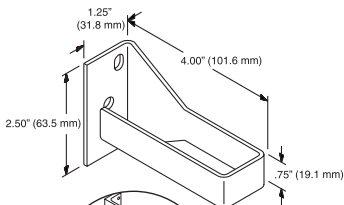

## Narrow Cable Loop

Use these cable loops to hold and dress cable vertically. Attach to walls or racks where width is limited. Mounting hardware not included.

- Made of aluminum with rounded edges to reduce cable insulation damage
- Narrow Cable Loop is 2.50"H x 1.25"W x 4.00"D (63.5 mm x 31.8 mm x 101.6 mm)
- Sold individually or box of 100

Part Number		Description
Individually	Box of 100	
11230-X01	11230-X11	Narrow Cable Loop

X=color: 1=Gray, 2=Computer Beige, 5=Clear, 7=Black, E=Glacier White.

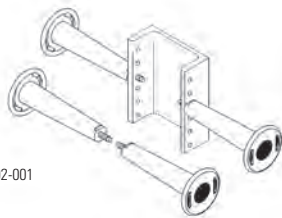

15002-001

## Cable Distribution Spools

Cable Distribution Spools provide a gradual bend for cable runs to aid in complying with ANSI/TIA/EIA-568B bend radius requirements (typically 4X the cable diameter). Routes all types of cabling from horizontal to vertical or vice-versa.

- The kit includes a #12-24 rack screw and a wood screw for use with the 4" (100 mm) spool
- Made of high-impact plastic

Part Number		Description in (mm)
Individually	Box of 100	
15002-001	15002-002	4 (100) Cable Spool



Spools mounted on a double-sided vertical cabling section

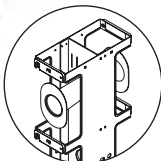

## Cable Distribution Spools

Cable Distribution Spools provide slack management and strain relief for patch cords and jumper cables inside CPI Vertical Cable Managers. Designed for use inside any CPI double-sided vertical cable manager 10"W and wider, including VCS, MCS, MCS-EFX, CCS, CCS-EFX and Evolution® g2 Double-Sided Vertical Cable Manager. Also compatible with Evolution® g1 Single-Sided Vertical Cable Manager.

- Three large cable distribution spools are included with each 10", 12" and 15"W (250 mm, 300 mm and 380 mm) vertical cable manager (will not fit other sizes)
- Attaches to the fixed adapter panels on the back of single-sided vertical cable managers and the Movable Mid-Sections inside the double-sided vertical cable managers
- Spools are 2.75" (69.9 mm) in diameter, 5.9"L (150 mm) and made from black plastic
- Each kit includes four spools and mounting hardware
- Made of high-impact, flame retardant material

Part Number	Description/Color	Shipping Weight lb (kg)
15008-001	Spool Kit, Black	2 (0.9)
15008-002	Spool Kit, Computer Beige	2 (0.9)

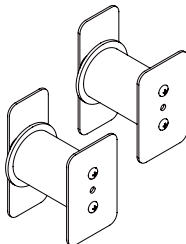

## 2" (50 mm) Diameter Fiber Management Spools

Use the 2" (50 mm) Diameter Fiber Management Spool to support fiber and copper cables within CPI's extensive line of vertical cabling sections. The spools meet EIA/TIA bend radius requirements, and minimize cable tangles and tears for more efficient data transmission.

- Provides proper cable support and bend radius for more efficient data transmission
- Maintains strength under heavy cable loads
- Mounts to all CPI vertical cabling sections 6"W (150 mm) or wider, including MCS, MCS-EFX, CCS, CCS-EFX and VCS

2" (50 mm) Diameter Fiber Management Spools			
Part Number	Application Width in (mm)	Package Of	Shipping Weight lb (kg)
12766-X02	For 6, 10 or 12 (150, 250 or 300) Double-Sided Cabling Sections	2	2 (0.9)
12766-X07	For 6, 10 or 12 (150, 250 or 300) Double-Sided Cabling Sections	7	5 (2.3)

X=color: 7=Black, E=Glacier White



## Evolution® Horizontal Cable Manager

Use Evolution® Horizontal Cable Managers above and below patch panels and network switches to organize and store cables. Horizontal managers include plastic T-shaped cable guides to organize patch cords and jumper cords as the cords enter and exit the manager to make individual equipment connections. The snap-on cover matches the door styling on the vertical manager. Swing the cover up or down to access cables; the cover stays in the open position while cabling. Three edge-protected, oval-shaped pass-through ports allow patch cords to pass front-to-rear. Horizontal managers are available in three heights.

- Contoured front door with snap-hinges and longitudinal center features contrasting aluminum finish
- Three 1.25"H x 2.12"W (31 mm x 53 mm) edge-protected oval cable pass-through ports at the rear of the cable manager
- Improved T-shaped cable guides decrease deflection when loaded with cables, especially important when deploying Cat 6a cable
- Rounded edges on the cable guides protect cables as they enter and exit the storage space
- Snap-On cover opens up or down and stays in the open position

Part Number	Description H x W x D in (mm)	Shipping Weight lb (kg)
35441-X01	1U x 19 x 8.2 (208)	4 (1.8)
35441-X02	2U x 19 x 8.2 (208)	5 (2.3)
35441-X03	3U x 19 x 8.2 (208)	6 (2.7)
35441-X04	4U x 19 x 8.2 (208)	7 (3.2)

*X=*color: *7=*Black, *E=*Glacier White.



## Velocity® Horizontal Cable Manager

Use Velocity® Horizontal Cable Manager above and below patch panels and network switches to organize and store cables. Features T-shaped cable guides at the top and bottom of the manager to organize patch cords. Two cable openings in the rear of the manager allow front-to-rear cabling, and the snap-on cover stays in the opened position to provide easy access to cables. The single-sided horizontal cable managers are available in three heights.

- Horizontal managers for open two- and four-post CPI Rack Systems
- The Velocity Horizontal Cable Manager includes:
  - One 19"W EIA rack-mount cable manager with T-shaped cable guides
  - One cover that snaps-on to the T-shaped cable guides
  - Four #12-24 x 1" rack-mount screws and four M6 x 25 mm rack-mount screws

Part Number	Description H x W x D in (mm)	Shipping Weight lb (kg)
13930-701	1U x 19 x 5.9 (150)	2 (0.9)
13930-702	2U x 19 x 5.9 (150)	3 (1.4)
13930-703	3U x 19 x 5.9 (150)	3 (1.4)

*Color is black. 1U = 1.75" (44.45 mm); the overall height of the manager is .03" (0.16 mm) less than the full rack-mount unit height. Usable depth is 3.7" (94 mm). The usable height of the manager varies but is 1.2" (31 mm) less than the overall height of the manager at the narrowest point.*

1U

2U

3U

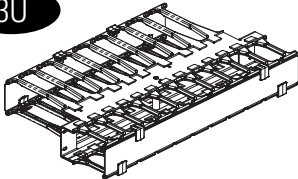

30530-X19

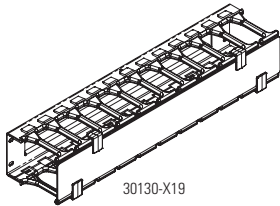

30130-X19

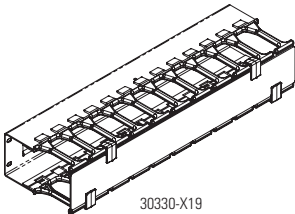

30330-X19

Use Universal Horizontal Cable Manager in conjunction with the CPI Patch Panel Wire Management Bar (P/N 12176-X01) and any of CPI's vertical cabling sections for clean, organized cable management.

## Universal Horizontal Cable Manager

Create an attractive and highly functional horizontal pathway for patch cords and multimedia applications using coax, copper and fiber optic cables. After routing the cables or cords, simply snap-on the cover for a clean, professional appearance.

- Extra-wide and contoured cable guide fingers, spaced 1.75" (44.5 mm) apart, separate and organize patch cords for quick and easy moves, adds and changes.
- The cable guides are offset to ensure proper bending radii of patch cables, even hooded patch cables
- Patented fingers meet the requirements of UL 94V-0 flammability rating
- Snap-on covers are easy to use and open 180° up or down with adjacent installation
- Covers and panel have a black powder-coat textured finish, reducing fingerprints and smudges

### Double-Sided Universal Horizontal Cable Manager

Part Number	Description H x W x D in (mm)	Shipping Weight lb (kg)
30529-X19	1U x 19 x 11.73 (297.9)	5 (2.3)
30529-X23	1U x 23 x 11.73 (297.9)	6 (2.7)
30530-X19	2U x 19 x 11.73 (297.9)	6 (2.7)
30530-X23	2U x 23 x 11.73 (297.9)	7 (3.2)
30531-X19	3U x 19 x 11.73 (297.9)	6 (2.7)
30531-X23	3U x 23 x 11.73 (297.9)	7 (3.2)

X=color: 7=Black, E=Glacier White.

### Single-Sided Universal Horizontal Cable Manager

Part Number	Description H x W x D in (mm)	Shipping Weight lb (kg)
30139-X19	1U x 19 x 4.96 (126.0)	2 (0.9)
30139-X23	1U x 23 x 4.96 (126.0)	3 (1.4)
30130-X19	2U x 19 x 5.14 (130.6)	3 (1.4)
30130-X23	2U x 23 x 5.14 (130.6)	4 (1.8)
30131-X19	3U x 19 x 5.14 (130.6)	4 (1.8)
30131-X23	3U x 23 x 5.14 (130.6)	5 (2.3)
30339-X19*	1U x 19 x 6.26 (159.0)	3 (1.4)
30339-X23*	1U x 23 x 6.26 (159.0)	3 (1.4)
30330-X19*	2U x 19 x 6.44 (163.6)	4 (1.8)
30330-X23*	2U x 23 x 6.44 (163.6)	5 (2.3)
30331-X19*	3U x 19 x 6.44 (163.6)	5 (2.3)
30331-X23*	3U x 23 x 6.44 (163.6)	6 (2.7)

X=color: 7=Black, E=Glacier White. \*Note: Deep Panel is used when Double-Sided MCS Master Cabling Sections are center-mounted on 3"D racks.



## Horizontal Cable Management Accessories

### Patch Panel Wire Management Bar

19" rack-mountable bar provides the necessary wire management and strain relief required by ANSI/TIA/EIA-568-B. May be mounted inward for 6" (150 mm) channel or outward to standard 3" (80 mm) rack side channel; attaches to rack with standard #12-24 rack screws (not included). Wire tie holes maintain wire perpendicular relative to termination point; made of sturdy aluminum and sold individually.

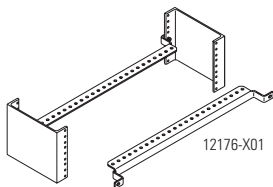

### Horizontal Wire Management Panel for VCS

19" Wire Management Panel is offset 1.5" (38 mm) from the rack channel to ensure proper bending radii of patch cables, even hooded patch cables. Use in combination with VCS Vertical Cabling Sections. Unique offset design provides patch cable pathway from front-to-back or side-to-side. Available in single 1.75" (44.5 mm) or double 3.5" (89.0 mm) rack-mount unit designs. Mounts quickly and easily using threaded cable distribution spools; cable distribution spools maintain bend radius through the pass-through trough and across the front plane of the horizontal manager.

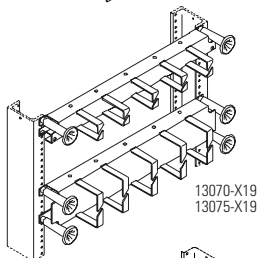

### Horizontal Wire Management Panel for MCS and CCS

Use in combination with MCS Master Cabling Section and CCS Combination Cabling Section to provide open horizontal management for cables.

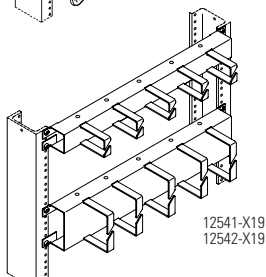

### Clip-On Cable Cover

The Clip-On Cable Cover is designed for use with the CPI 19" Horizontal Wire Management Panels. Attach to the horizontal wire management panel by simply sliding/clipping it into place.

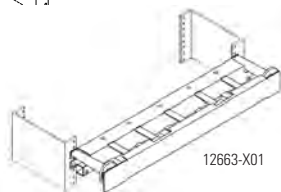

### Slip-On Cover, Ring Panel

The Slip-On Cover is used on the Large Horizontal Ring Panel, P/N 11564-XXX. Sold individually.

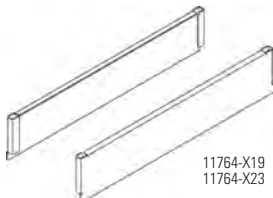

Part Number	Description	Shipping Weight lb (kg)
12176-X01	Patch Panel Wire Management Bar	1 (0.5)
13070-X19	Horizontal Wire Panel for VCS, 1U	2 (0.9)
13075-X19	Horizontal Wire Panel for VCS, 2U	2 (0.9)
12541-X19	Horizontal Wire Panel for MCS/CCS, 1U	2 (0.9)
12542-X19	Horizontal Wire Panel for MCS/CCS, 2U	2 (0.9)
12663-X01	Cable Cover for 13070-XXX, 1U	2 (0.9)
12663-X02	Cable Cover for 13075-XXX, 2U	2 (0.9)
11764-X19	Slip-On Cover, 19"W, for 11564-X19	2 (0.9)
11764-X23	Slip-On Cover, 23"W, for 11564-X23	2 (0.9)

X=color: 1=Gray, 2=Computer Beige, 5=Clear, 7=Black, E=Glacier White.

2U

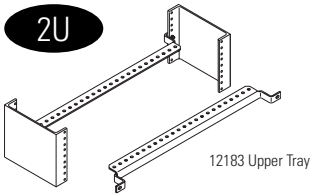

12183 Upper Tray

2U

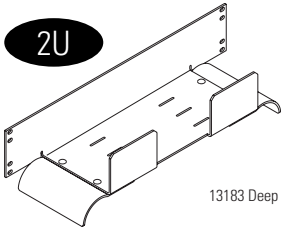

13183 Deep Upper Tray

2U

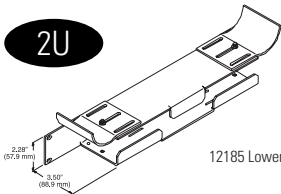

12185 Lower Tray, Single

3U

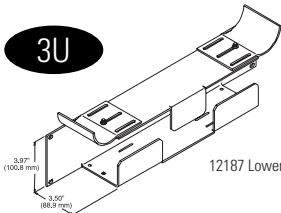

12187 Lower Tray, Double

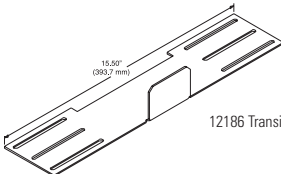

12186 Transition Plate

## Jumper And Transition Trays

The Jumper and Transition Trays aid in compliance with ANSI/TIA/EIA-568B bend radius requirements. Two styles are available to provide upper and lower horizontal/vertical cable management and promote a gradual, controlled bend for both UTP and optical fiber cable. Adjust the position of the bend radius to deliver cables into the vertical cable manager or attach a transition plate between trays to create a solid wire way between racks. Mounting screws not included. Sold individually.

- Provides 1-1/2" (38 mm) bend radius for compliant installation of Category 5e/6/6a or fiber cable
- Telescopes to adjust cable entry or exit position
- Mounts on 19" or 23" rack; may also be wall-mounted
- Strong lightweight aluminum construction

Part Number		Description	Shipping Weight lb (kg)
19"	23"		
12183-X19	12183-X23	Upper Tray, 3.5"D (89 mm)	3 (1.4)
13183-X19	13183-X23	Upper Tray, 6"D (150 mm)	4 (1.8)
12185-X19	12185-X23	Lower Tray, Single, 3.5"D (89 mm)	4 (1.8)
12187-X19	12187-X23	Lower Tray, Double, 3.5"D (89 mm)	5 (2.3)
12186-X01	N/A	Transition Plate, 15.5"L (394 mm)	2 (0.9)

*X=*color: 1=Gray, 2=Computer Beige, 5=Clear, 7=Black, E=Glacier White.

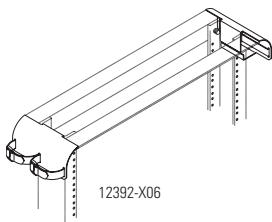

12392-X06

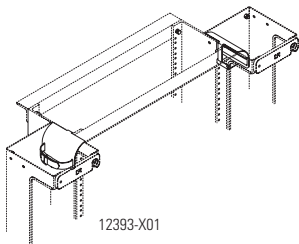

12393-X01

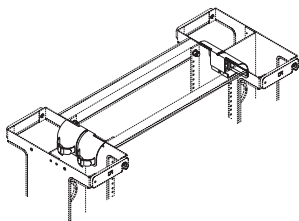

12394-X01

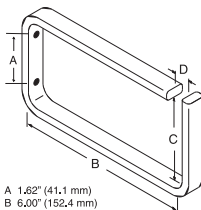

A 1.62" (41.1 mm)  
 B 6.00" (152.4 mm)  
 C 2.85" (72.4 mm)  
 D 0.56" (14.2 mm)

## Rack Radius Drop

The Rack Radius Drop provides a transition from a horizontal cable run onto a rack, while maintaining the recommended bend radius. Cable bundles are held securely in place on the Rack Radius Drop by using the included Saf-T-Grip® Center Grommet Buckle Cable Management Strap; 9" L (230 mm) for 12392-X09 and 12393-X01 and 6" L (150 mm) for 12392-X06 and 12394-X01 only.

*Note: For UTP and STP-A, the required bend radius is no less than four times the cable diameter. For optical fiber, the required bend radius is either 10 times the cable diameter or 1.2" (30 mm), whichever is larger (reference BICSI TDDM).*

### Three styles are available:

- 1) 3" (80 mm) or 6" (150 mm) rack channels without vertical rack cabling sections use P/N 12392-X06, 3" (80 mm) or 12392-X09, 6" (150 mm)
  - 2) Single-sided vertical rack cabling managers use P/N 12393-X01
  - 3) Double-sided vertical rack cabling managers use P/N 12394-X01
- Provides an organized method to transition from horizontal cable run onto the rack, while maintaining bend radius; styles offered for use with or without vertical rack cabling sections
  - Provides 1-1/2" (38 mm) bend radius
  - Quick and easy slip-on installation onto rack channel
  - Sold individually

Part Number	Description in (mm)	Shipping Weight lb (kg)
12392-X06	Rack Radius Drop for 3 (80) Rack Channels w/o Vertical Cabling Sections	1 (0.5)
12392-X09	Rack Radius Drop for 6 (15) Rack Channels w/o Vertical Cabling Sections	1 (0.5)
12393-X01	Rack Radius Drop For Use with Single Sided Vertical Cabling Section	1 (0.5)
12394-X01	Rack Radius Drop For Use with Double Sided Vertical Cabling Section	1 (0.5)

*X=*color: 1=Gray, 2=Computer Beige, 5=Clear, 7=Black, E=Glacier White.

## Large Horizontal Cable Ring

This is the same ring used on our Large Horizontal Ring Panel series 11564. Sold individually and in quantities of 50.

- Provides horizontal cable management on wall
- 2.8"H x 6"W (71 mm x 150 mm) heavy duty aluminum rings
- Rounded edges protect cable sheaths

Part Number		Description	Shipping Weight lb (kg)
Each	Box of 50		
11563-X01	11563-X50	Cable Ring	19 (8.6)

*X=*color: 1=Gray, 2=Computer Beige, 5=Clear, 7=Black, E=Glacier White.

2U

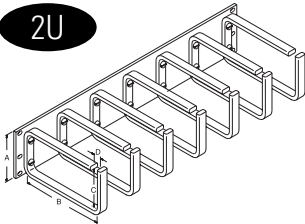

A 3.47" (88.1 mm)  
 B 6.00" (152.4 mm)  
 C 2.85" (72.4 mm)  
 D 0.56" (14.2 mm)

## Large Horizontal Ring Panel

Used to organize horizontal cable runs. Large 2.8"H (71 mm) by 6"W (150 mm) heavy duty aluminum rings with rounded edges protect cable sheaths and will not bind during installation. Rings are bolted onto panels, so they can be added or removed as needed. 19" and 23" wide rack panel options come pre-assembled with seven equally spaced rings.

- 2.8"H x 6"W (71 mm x 150 mm) heavy duty aluminum rings
- Rings can be added or removed as needed
- Installation hardware not included
- Shipping weight approximately 5 lb (2.3 kg)

Part Number		Description
19"	23"	
11564-X19	11564-X23	Ring Panel

X=color: 1=Gray, 2=Computer Beige, 5=Clear, 7=Black, E=Glacier White.

1U

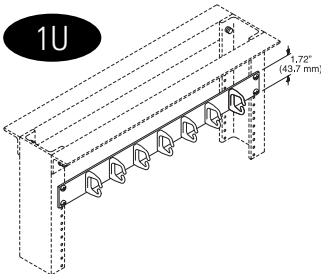

2U

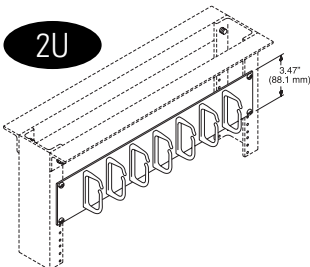

## Rack Cabling Managers

Used to organize horizontal cable and wire runs. Two sizes of slotted plastic rings provide ample room to hold all types and sizes of wiring and cabling.

- Easy to install on equipment racks
- Installation hardware not included

1175 Rack Cabling Managers	
Panel/Ring Size H x D - in (mm)	
2	1U, 1.6 x 1.3 (41 x 33) Rings
3	2U, 3 x 1.6 (80 x 41) Rings
Color	
1	Gray
2	Computer Beige
5	Clear
7	Black
E	Glacier White
Rack Width	
19	19"W
23	23"W
1175	X - X XX



Open Loop Series

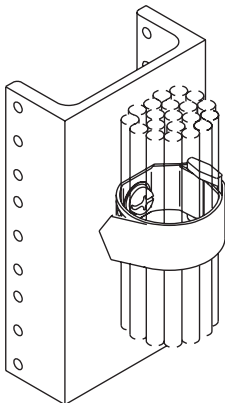

Center Grommet & Buckle Series

## Saf-T-Grip® Open Loop Series

Used to strap together free hanging computer cable for a tangle-free installation. Strap is held in place by a loop that adheres to one cable. Simply peel the hook and loop sides apart to remove strap.

## Saf-T-Grip® End Grommet Buckle Series

The buckle design provides extra strength for those harder to manage cables. Mounts cable along walls and backboards or wherever horizontal cable runs are required. Wrap this strap around the cable and back through the nylon buckle. Pull snugly, cinching down the cable for secure fit.

## Saf-T-Grip® Center Grommet Buckle Series

The buckle design provides twice the holding strength of ordinary straps. Unique center grommet feature provides a sturdy fixture for attaching straps in any direction. Simply loop the strap around cables and back through the buckle. Secure cinch back and down for a secure hold.

Saf-T-Grip Strap Series Type	
020	Open Loop Series (pkg. of 25)
050	End Grommet & Buckle Series (pkg. of 25)
060	Center Grommet & Buckle Series (pkg. of 25)

Strap Length - in (mm)	
06	6 (150), for 2 (50) diameter cable bundles
09	9 (230), for 3 (80) diameter cable bundles
12	12 (300), for 4 (100) diameter cable bundles

Strap Width - in (mm)	
2	3/4 (19.1)

Strap Colors	
01	Black
03	Royal Blue

OXO	XX	-	X	XX
-----	----	---	---	----

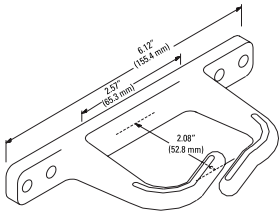

### Open Composite Distribution Ring

Supports cable and wire in communication closets, on backboards, equipment racks or wherever cable runs are required. These rings are made of high-strength, fire-retardant material with rounded edges to prevent damage to cable and wire insulation, while providing easy pull-through. Mounting hole configuration allows rings to be attached to most surfaces, including CPI equipment racks. The open designed "C" rings allow for easy adds, moves and changes, eliminating the need to feed through cable. Mounting hardware not included.

- Organizes equipment wiring and cabling
- Strong, lightweight composite construction
- Eliminates cable nicks, great for wire pulling
- Split ring style allows easy additions or changes to cable runs
- Molded of fire-retardant material

Part Number	Description H x W x D in (mm)	Shipping Weight lb (kg)
12035-001	2 (50) Open "C" Ring, Gray	1 (0.5)
12035-011	Carton of 100	6 (2.7)

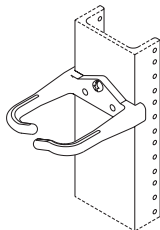
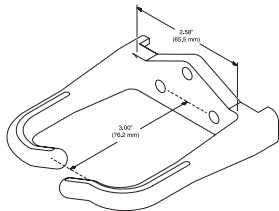

11125 shown on Rack

### Channel-Mounted Distribution Ring

Designed to mount to the upright channels of CPI Universal Racks. Made of high-strength, fire-retardant material with rounded edges to prevent damage to cable and wire insulation, while providing easy pull-through. The open-design "C" rings allow for easy adds, moves and changes, eliminating the need to feed through cable. Mounting hardware not included.

- Mounts on CPI Universal Racks only
- Organizes equipment wiring and cabling
- Strong, lightweight composite construction
- Split ring style allows easy additions or changes to cable runs
- Molded of fire-retardant material
- Sold individually and in quantities of 100
- Internal dimensions: 2.58" W (65.5 mm) x 3"D (76.2 mm)
- Overall dimensions: 3.58" (90.9 mm) x 3.93" (99.8 mm); projects 3.68" (93.5 mm) past the sides of the rack channel

Part Number		Description	Shipping Weight
Each	Box of 100		
11125-001	11125-011	3 (80) Open "C" Ring, Beige	9 (4.1)
11125-003	11125-013	3 (80) Open "C" Ring, Black	9 (4.1)

Shipping Weights are for Box of 100.

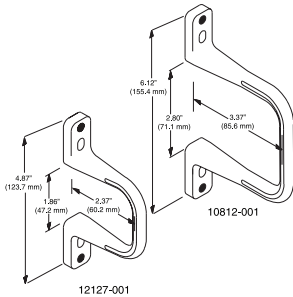

## Closed Composite Distribution Rings

With Distribution Rings, all your wiring and cabling can now be neatly and easily organized and managed. Designed to support cable and wire in communication closets, on backboards, equipment racks or wherever cable runs are required. The versatile brackets are made of high-strength, fire-retardant composite material. Rounded edges prevent damage to cable and wire insulation, while providing easy pull-through. Mounting hole configuration allows brackets to be attached to most surfaces, including CPI equipment racks. Color is compatible with most equipment. Mounting hardware not included.

- Strong, lightweight, fire-retardant composite material construction
- Easy to install onto CPI equipment racks or backboards
- Rounded shape eliminates cable nicks, great for wire pulling

Part Number		Description	Shipping Weight lb (kg)
Each	Box of 100		
12127-001	12127-011	2 (50) Closed "D" Ring	6 (2.7)
10812-001	10812-011	3 (80) Closed "D" Ring	9 (4.1)

Color is gray. Shipping Weights are for Box of 100.

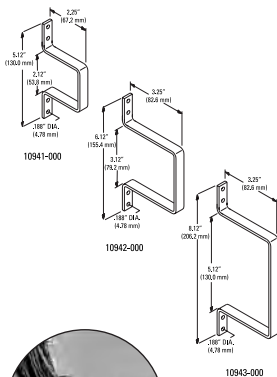

## Metal D-Rings

A convenient and economical way to route, support and secure cables and jumper wires in terminal closets or wherever cable runs are required.

- Offered in three standard sizes
- Made from 1/8" x 1/2" (3.18 mm x 13 mm) hot-rolled steel strap with zinc plating to resist corrosion
- Ring edges are rolled to prevent nicks and scratches in the cable and wire insulation
- Mounting hardware not included

Part Number		Description	Shipping Weight lb (kg)
Each	Box of 100		
10941-000	10941-010	Small Rings	16 (7.3)
10942-000	10942-010	Medium Rings	22 (10.0)
10943-000	10943-010	Large Rings	24 (10.9)

Shipping Weights are for Box of 100.

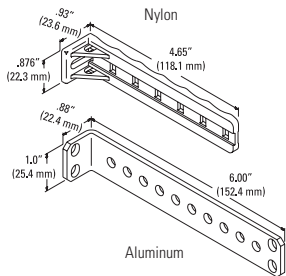

## Stand-Off Tie Bracket

These brackets mount to the back of the rack channel to provide a convenient point to tie-down cable runs.

- Choice of either non-conductive nylon or high-strength aluminum
- Either end of the aluminum bracket can be attached to rack, allowing cabling to run several different ways
- Mounting hardware not included

Part Number		Description	Shipping Weight lb (kg)
Each	Box of 50		
10001-001	10001-050	1 x 5 (30 x 130), White Nylon	3 (1.4)
10559-X00	10559-X50	1 x 6 (30 x 150), Aluminum	5 (2.3)

X=color: 1=Gray, 2=Computer Beige, 5=Clear, 7=Black, E=Glacier White.  
Shipping Weights are for Box of 50.

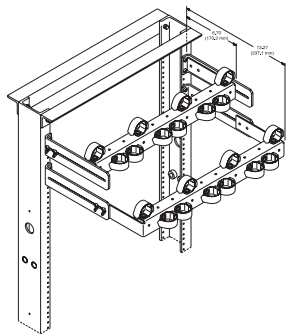

## Cable Strain Relief Bracket

Have you ever pulled cables out of rack-mounted equipment accidentally? Do you need to maintain a minimum bend radius for your cabling? CPI's Rack-Mounted Cable Strain Relief Bracket is the answer. Made of high-strength aluminum, it includes ten flexible Saf-T-Grip® Cable Management Straps. This bracket can be mounted at desired height and depth to position straps right where you need them. Reusable rivets allow Saf-T-Grips to be added or removed as required. Aluminum construction.

- Mounting hardware not included

Part Number	Description	Shipping Weight lb (kg)
11570-X19	19" Rack	1 (0.5)
11570-X23	23" Rack	1 (0.5)

X=color: 1=Gray, 2=Computer Beige, 5=Clear, 7=Black, E=Glacier White.

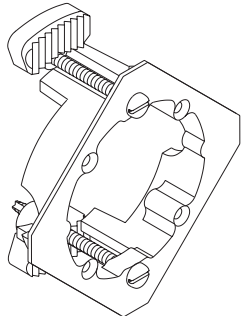

## Jack Plate Wall-Mounting Bracket

This innovative flush-mount wall board bracket is designed to hold round style modular jack plate assemblies. To install, simply drill a 2-3/8" (60.33 mm) diameter hole into dry wall, insert bracket into hole and using a flat blade screwdriver, tighten patented size-grip pads to hold securely in place. Adjustable pads handle most wall sizes up to 1" (25.4 mm) thick. Clear plastic flush mount design is invisible when installed. Four screws hold pattern to fit round, modular jack rings. Includes two #6-32 machine screws. For AT&T and Regional Bell Operating Co., use with modular jack plate assemblies, such as Allen-Tel AT218 or Suttle SE-625B2 (not included).

Part Number		Description	Shipping Weight
Each	Box of 200		
20502-002	20502-022	Jack Plate Wall-Mounting Bracket	12 (5.4)



# CABLE MANAGEMENT ACCESSORIES

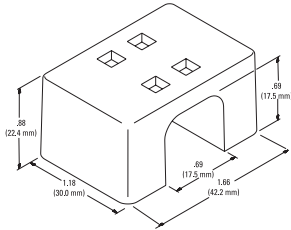

## Mag-Clips, Medium Sized

The medium-sized 17000 and 17100 magnetic clips are designed to hold a 25-pair cable or several electrical cords. Keeps cables within workstation areas neat and off of the floor to reduce the chance of accidents. Nylon cable ties can be laced through the four square holes in the top of the 17000 series to secure additional cables.

Part Number		Description	Shipping Weight lb (kg)
Each	Box of 50		
17000-X00	17000-X50	Clip With Holes	7 (3.2)
17100-X00	17100-X50	Clip Without Holes	7 (3.2)

*X=*color: 0=Gray, 1=Computer Beige. Shipping Weights are for Box of 50.

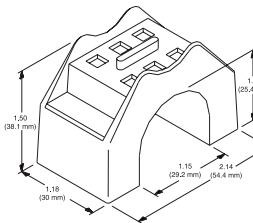

## Mag-Clips, Large

This larger clip holds a 100-pair telephone cable or up to 1" (30 mm) diameter tubing. There are also holes provided to lace additional cords to the top of the clip. The amount of direct pull required to separate the clips from a painted steel surface averages 15 lb (67 kg).

Part Number		Description	Shipping Weight lb (kg)
Each	Box of 25		
17500-X00	17500-X20	Clip	7 (3.2)

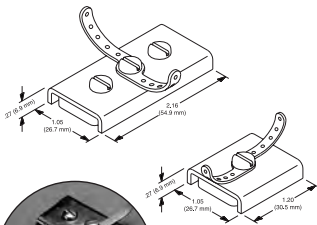

## Mag-Clips, Wrap-Around Clasp

The wrap-around clasp easily secures a 25-pair cable, approximately 7/16" (11.113 mm) diameter, or a similar size cable, cord or tubing. The double-magnetic style has extra clasp-mounting screws, allowing them to hold two cables with the addition of another clasp. Incorporate either a single or double magnet assembly to provide sufficient holding power.

- Direct pull required to separate these magnets from a painted surface averages 5 lb (22 kg) for the single magnetic style and 12 lb (53 kg) for the double magnet style
- Finished in Chem Film over zinc plating
- Extra clasps may be ordered separately

Part Number	Description	Shipping Weight lb (kg)
17250-000	Single Wrap-Around Clip	1 (0.5)
17350-000	Double Wrap-Around Clip	1 (0.5)
17260-001	Extra Clasps, Small	1 (0.5)
17260-002	Extra Clasps, Large	1 (0.5)



# CABLE RUNWAY & TRAY PRODUCTS

Cable Runway, Wire Mesh Cable Tray & Accessories



OnTrac® Wire Mesh Cable Tray System

Page 3-3

Cable Runway Products

Page 3-11

Cable Runway Junction Products

Page 3-18

Auxiliary Frame Products

Page 3-25

Cable Runway Support Products

Page 3-30

Cable Runway Accessories

Page 3-39

# CABLE RUNWAY & TRAY PRODUCTS

As long-time developers of quality Cable Runway and Tray Products, CPI understands installing a cable system goes beyond cable management (Section 2) and connecting two points together. As building designs change and data center needs evolve, Cable Runway and Tray Products must be sturdy, dependable and able to meet the latest standards. As a vital part of the IT infrastructure solution, CPI meets ANSI/TIA/EIA installation guidelines for copper and fiber cables by providing horizontal, vertical and backbone pathways from the data center to workstations. UL Classified versions are also available to meet specific code or job requirements.

CPI Runway Products offer complete runway and ladder rack solutions that integrate pathway systems within and outside of the equipment room and under access floors. Spanning from the point of entry/exit into the telecommunications or equipment room, to cross-connects between racks and cabinets, CPI can supply a backbone or horizontal cable solution for any situation.

Overcome structural obstacles with the flexible pathway solutions found among CPI's Cable Tray Products. Installed quickly and easily, these cabling solutions can be cut to form smooth, curved transitions that adapt to any obstruction or infrastructure need.

## **CPI Cable Runway & Tray Products feature:**

- High-quality construction and design
- Promote proper cable bend radii for better data transmission
- Decrease cable damage
- Simplify equipment moves, additions and changes
- Prevent tangled cords
- Meet ANSI/TIA/EIA installation guidelines for copper and fiber cables
- UL Classified cable runway and tray options available to meet specific job requirements

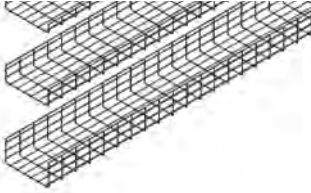

## OnTrac® Wire Mesh Cable Tray System

CPI's OnTrac® Wire Mesh Cable Tray System is an excellent solution for indoor cable pathway applications to create point-to-point pathways for network cabling in data centers, network equipment rooms and office spaces. In addition to standard tray, we now offer OnTrac Shaped Tray as an option when supporting high performance and high-density cabling. OnTrac Wire Mesh Cable Tray is available in two styles: Shaped Tray and Standard Tray. Shaped Tray is the best choice for high-density cabling applications because it features flattened cross wires to provide a larger surface for supporting cables.

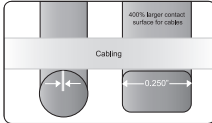

Select tray size based on cable fill ([www.chatsworth.com/cablefill](http://www.chatsworth.com/cablefill)) requirements, considering the space available for trays in the location. Some sites will use multiple sizes. When stacked, leave at least 12" (300 mm) between trays. Trays are sold in standard 10'L (3 m) lengths. Note that the trays are available in different finishes, but both tray styles use the same splices, supports and accessories.

Part Number *Pre-Galvanized		Nominal Dimensions		Cable Fill Area		Max. Load 6'L (1.8 m) Span		Splices	Shipping Weight lb (kg)	
Shaped Tray	Standard Tray	Height in (mm)	Width in (mm)	in <sup>2</sup>	mm <sup>2</sup>	30" OD Cable	lb/ft	kg/m		Min. Qty.
36811-604	34811-604	2 (50)	4 (100)	8.2	5290	58	43	63.9	2	11 (5.0)
36811-606	34811-606	2 (50)	6 (150)	12.4	8000	88	50	74.4	4	12 (5.4)
36811-608	34811-608	2 (50)	8 (200)	16.6	10 710	117	52	77.3	4	14 (6.4)
36811-612	34811-612	2 (50)	12 (300)	24.8	16 000	175	58	86.3	4	17 (7.7)
36811-616	34811-616	2 (50)	16 (400)	33.4	21 550	236	70	104.1	4	20 (9.1)
36811-618	34811-618	2 (50)	18 (450)	37.6	24 260	266	70	104.1	4	21 (9.5)
36811-620	34811-620	2 (50)	20 (500)	41.8	26 970	296	73	108.6	5	23 (11.8)
36811-624	34811-624	2 (50)	24 (600)	50.2	32 390	355	75	111.6	5	26 (11.8)
36821-604	34821-604	4 (100)	4 (100)	15.6	10 060	110	45	66.9	4	14 (6.4)
36821-606	34821-606	4 (100)	6 (150)	23.6	15 230	167	49	72.9	5	16 (7.3)
36821-608	34821-608	4 (100)	8 (200)	31.6	20 390	224	78	116.0	6	18 (8.7)
36821-612	34821-612	4 (100)	12 (300)	47.2	30 450	334	78	116.0	6	21 (8.5)
36821-616	34821-616	4 (100)	16 (400)	63.6	41 030	450	108	160.7	7	24 (10.9)
36821-618	34821-618	4 (100)	18 (450)	71.6	46 190	506	116	172.6	7	25 (11.3)
36821-620	34821-620	4 (100)	20 (500)	79.6	51 350	563	116	172.6	7	27 (12.2)
36821-624	34821-624	4 (100)	24 (600)	95.6	61 680	676	116	172.6	8	30 (13.6)
36831-608	34831-608	6 (150)	8 (200)	47.4	30 580	335	116	172.6	6	22 (10.0)
36831-612	34831-612	6 (150)	12 (300)	70.8	45 680	501	123	183.0	6	25 (11.3)
36831-616	34831-616	6 (150)	16 (400)	95.4	61 550	675	123	183.0	7	28 (12.7)
36831-618	34831-618	6 (150)	18 (450)	107.4	69 290	760	127	189.0	7	29 (13.2)
36831-620	34831-620	6 (150)	20 (500)	119.4	77 030	845	127	189.0	7	31 (14.1)
36831-624	34831-624	6 (150)	24 (600)	143.4	92 520	1014	150	223.2	8	34 (15.4)



- Notes:
- 1) Above part numbers have a pre-galvanized finish and are UL Classified in U.S. only except for 2"H x 4"W (50 mm x 100 mm) Standard Tray (P/N 34811-X04), which is not UL Classified regardless of finish.
  - 2) Above products also available in Black (-7XX) and Glacier White (-EXX) finishes. Only Standard Tray is available in Zinc electroplate finish (-5XX). Black, Glacier White and Zinc finishes are UL Classified in the U.S. and Canada. Zinc electroplate finish has longer lead time.
  - 3) Max. Load is reduced by 20% (multiply by 0.8) when tray is spliced using the Spring Splice Kit (P/N 34834-501 or 34834-701). Spring Splice Kit cannot be used with Shaped Tray.

## ONTRAC® WIRE MESH TRAY ACCESSORIES

### Standard Splice Kit

Use to connect sections of cable tray together end-to-end at intersections and turns. Each splice kit includes: a stamped washer with a fixed screw, a contoured splice washer and a flange nut. The two splice halves wrap around adjacent wires, connecting the tray together.

### Splice Washer & Bolt Kit

Use with Splice Bar (P/N 34739-X01) to connect trays together end-to-end for securing to ceiling, wall and access floor supports or to attach accessories. Includes a stamped washer with a fixed screw, carriage bolts and a flange nuts.

### Spring Splice Kit

Use to connect sections of Standard Tray together end-to-end. Cannot be used with Shaped Tray. Quick installation with included tool; sold in packs of 50.

### Splice Bar

Use with splices from the Splice Washer & Bolt Kit (P/N 34728-X01) to create secure end-to-end connection between cable tray sections. Attaches to the side of the tray using three splice washers from the Splice Washer & Bolt Kit (P/N 34728-X01). Recommended for all trays that are 18"W (450 mm) or wider. Manufactured from steel, 10.8"L (274.6 mm).

### Clamp Washer

Securely fasten two layers of wire mesh when connecting trays at 90° bends or intersections or to attach tray to support. Attaches to the tray using a carriage bolt and flange nut from P/N 34728-X02.

### Carriage Bolt Hardware

Use with Clamp Washer to connect wire mesh trays together. Includes carriage bolt and flange nut. Use to attach dividers and horizontal radius together.

### 90° Splice Bar Kit

Create a secure 90° T- or L-shaped intersection between two cable tray sections. Kit includes all hardware needed to make one 90° intersection. 90° T-shaped or two L-shaped splice bars are manufactured from steel, 5-31/32" (152 mm).



34738-X01



34728-X01



34834-X01



34739-X01



34746-X01

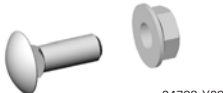

34728-X02



34740-X01

Part Number & Finish		Description	Shipping Weight lb (kg)
Black	Zinc		
34738-701	34738-501	Standard Splice Kit, Pack of 50	11 (5.0)
34728-701	34728-501	Splice Washer & Bolt, Pack of 50	2 (0.9)
34834-701	34834-501	Spring Splice Kit	9 (4.1)
34739-701	34739-501	Splice Bar, Pack of 50	12 (5.4)
34746-701	34746-501	Clamp Washer, Pack of 25	2 (0.9)
34728-702	34728-502	Carriage Bolt Washer, Pack of 50	2 (0.9)
34740-701	34740-501	90° Splice Bar Kit	2 (0.9)



34734-7XX



34730-7XX



34731-701

## L Support Bracket Kit

Use to support a wire mesh cable tray pathway along a wall or under a floor. Installation requires two 3/8" lag bolts and two flat washers for plywood backer boards or two 1/4" hex cap bolts, two flat washers and two appropriate anchors for concrete walls (order separately). Use the 16"W (400 mm) or smaller version to support cable tray from an access floor pedestal. Attach to the pedestal with a single Pedestal Clamp Bracket Kit (P/N 34737-X01); floor height must be at least 12" (300 mm). Attach tray to the L Support Bracket with two splice washers from the Splice Washer & Bolt Kit (P/N 34728-X01), or use the fold-over tab at the end of the bracket to secure the tray. Can be used to support multiple trays of varying widths; the combined width of multiple trays must not exceed the width of the tray stated in the order table below. Manufactured from steel; length varies, sold individually.

## Trapeze Support Bracket

Use to support wire mesh cable tray from the ceiling using a pair of threaded rods. Installation requires a pair of 1/2", 3/8" or 1/4" threaded rods, four hex nuts, two (1/2") or four (3/8", 1/4") flat washers, two split lock washers and two appropriate anchors/ceiling clamps (order separately). Tray attaches to the Trapeze Support Bracket with two splice washers from the Splice Washer & Bolt Kit (P/N 34728-X01). Can be used to support multiple trays of varying widths; the combined width of multiple trays must not exceed the width of the tray stated in the order table below. Manufactured from steel; length varies, sold individually.

## Edge Hanger

Use in pairs to support wire mesh cable tray from the ceiling using threaded rod. Installation requires a single 3/8" or 1/4" threaded rod, two hex nuts, one 3/8" or two 1/4" flat washers, one split lock washer and an appropriate anchor/ceiling clamp (order separately). The side of the tray is supported in the two J-shaped hooks at the bottom of the hanger; use pliers to close hooks, and secure tray once cable has been loaded. Use in pairs to support a single cable tray. Manufactured from steel.

Part Number	Description Width in (mm)	Shipping Weight lb (kg)
34734-X04	L Support Bracket, for 4 (100) Tray	1 (0.5)
34734-X08	L Support Bracket, for 8 (200) Tray	2 (0.9)
34734-X12	L Support Bracket, for 12 (300) Tray	2 (0.9)
34734-X16	L Support Bracket, for 16 (400) Tray	3 (1.4)
34734-X20	L Support Bracket, for 20 (500) Tray	3 (1.4)
34734-X24	L Support Bracket, for 24 (600) Tray	4 (1.8)
34730-X12	Trapeze Support Bracket, for 12 (300) Tray	2 (0.9)
34730-X16	Trapeze Support Bracket, for 16 (400) Tray	2 (0.9)
34730-X20	Trapeze Support Bracket, for 20 (500) Tray	3 (1.4)
34730-X24	Trapeze Support Bracket, for 24 (600) Tray	3 (1.4)

X=finish; 5=Zinc, 6=Pre-Galvanized, 7=Black, E=Glacier White.

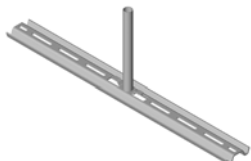

34729-7XX



34733-7XX



34735-7XX

## Center Support Bracket

Use to support wire mesh cable tray from the ceiling with a single 3/8" threaded rod. Attach tray to the Center Support Bracket with two splice washers from the Splice Washer & Bolt Kit (P/N 34728-X01), or use fold-over tabs to secure the tray on all sizes, except the 4"W (100 mm) version. Used to support a single cable tray. Manufactured from steel; length varies, sold individually.

## Triangle Support Bracket

Use to support a wire mesh cable tray pathway along a wall. Installation requires two 3/8" lag bolts and two flat washers for plywood backer boards or two 1/4" hex cap bolts, two flat washers and two appropriate anchors for concrete walls (order separately). Attach Tray to the Triangle Support Bracket with two splice washers from the Splice Washer & Bolt Kit (P/N 34728-X01), or use the fold-over tab at the end of the bracket to secure the tray. Manufactured from steel; height and length vary, sold individually.

## Wall-Mount Angle

Use to support the end of wire mesh cable tray against the wall. Installation requires two 1/4" lag bolts and two flat washers for plywood backer boards or two 1/4" hex cap bolts, two flat washers and two appropriate anchors for concrete walls (order separately). Tray attaches to the Wall-Mount Angle with two splice washers from the Splice Washer & Bolt Kit (P/N 34728-X01). Manufactured from steel; length varies, sold individually.

Part Number	Description Width in (mm)	Shipping Weight lb (kg)
34729-X04*	Center Support Bracket, for 4 (100) Tray	1 (0.5)
34729-X08*	Center Support Bracket, for 8 (200) Tray	1 (0.5)
34729-X12*	Center Support Bracket, for 12 (300) Tray	2 (0.9)
34729-X16*	Center Support Bracket, for 16 (400) Tray	2 (0.9)
34729-X20*	Center Support Bracket, for 20 (500) Tray	2 (0.9)
34729-X24*	Center Support Bracket, for 24 (600) Tray	3 (1.4)
34733-X04	Triangle Support Bracket, for 4 (100) Tray	1 (0.5)
34733-X08	Triangle Support Bracket, for 8 (200) Tray	1 (0.5)
34733-X12	Triangle Support Bracket, for 12 (300) Tray	2 (0.9)
34733-X16	Triangle Support Bracket, for 16 (400) Tray	2 (0.9)
34733-X20	Triangle Support Bracket, for 20 (500) Tray	3 (1.4)
34733-X24	Triangle Support Bracket, for 24 (600) Tray	4 (1.8)
34735-X08**	Wall Mount Angle, for 8 (200) Tray	1 (0.5)
34735-X12**	Wall Mount Angle, for 12 (300) Tray	1 (0.5)
34735-X16**	Wall Mount Angle, for 16 (400) Tray	1 (0.5)
34735-X20**	Wall Mount Angle, for 20 (500) Tray	2 (0.9)
34735-X24**	Wall Mount Angle, for 24 (600) Tray	2 (0.9)

X=finish; 5=Zinc, 6=Pre-Galvanized, 7=Black, E=Glacier White.

\*Available in Zinc, Black & Glacier White finishes only.

\*\*Available in Pre-Galvanized, Black and Glacier White finishes only.



34737-501



34737-502



34732-X01

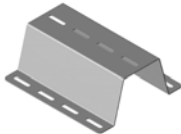

34736-7XX



34134-XXX



34140-XXX

## Pedestal Clamp Bracket

Use with the L Support Bracket to support tray from access floor pedestals under an access floor. Use one Pedestal Clamp Bracket to attach a 16" W (400 mm) or smaller L Support Bracket to an access floor pedestal.

## Pedestal Clamp Bracket Kit

Support wire mesh cable tray from adjacent access floor pedestals. Kit includes two Pedestal Clamp Brackets, a tray support bracket and installation hardware. Attaches to the tray support bracket with two splice washers (P/N 34728-X01). Can support multiple trays, varying widths; sold individually.

## Rack-Mount Hook

Attach wire mesh cable tray to the top of a two- or four-post CPI Rack System. Includes a Clamp Washer with a hook that attaches to the L-shaped top angle on Rack. Attach tray to the top of the rack in the parallel (side-to-side) or perpendicular (front-to-back) orientation; sold in packs of 4.

## Under Floor Support

Use to support wire mesh cable tray from the floor under an access floor. Attaches to the floor with 1/4" hardware or adhesive. Tray attaches to the Under Floor Support with a splice washer (P/N 34728-X01). Under Floor Supports can be used in pairs to support wider trays; sold individually.

## C Support Bracket

Use in pairs to support wire mesh cable tray against the wall and ceiling. Tray attaches to C-Bracket with two splice washers (P/N 34728-X01). Installation requires 1/4" (M6) hardware; sold separately.

## Under Floor C Bracket

Use in pairs to support two tiers of wire mesh cable tray under a raised floor. Attaches to floor pedestal with bracket (P/N 34737-501). Use two splice washers (P/N 34728-X01) to attach tray to C Support Bracket.

Part Number	Description H x W x D in (mm)	Shipping Weight lb (kg)
34737-501	Pedestal Clamp Bracket, Zinc	1 (0.5)
34737-502	Pedestal Clamp Bracket Kit, Zinc	4 (1.8)
34732-X01**	Rack-Mount Hook, Pack of 4, Black	1 (0.5)
34736-643	Under Floor, 3 x 4 x 7 (75 x 100 x 180)	1 (0.5)
34736-646	Under Floor, 6 x 4 x 8.6 (150 x 100 x 218)	2 (0.9)
34736-683	Under Floor, 3 x 8 x 7 (75 x 200 x 180)	2 (0.9)
34736-686	Under Floor, 6 x 8 x 8.6 (150 x 200 x 218)	3 (1.4)
34736-689	Under Floor, 9 x 8 x 10.2 (225 x 200 x 260)	4 (1.8)
34134-X04*	C Support Bracket, for 4 (100) Tray	3 (1.4)
34134-X08*	C Support Bracket, for 8 (200) Tray	3 (1.4)
34134-X12*	C Support Bracket, for 12 (300) Tray	3 (1.4)
34134-X18*	C Support Bracket for 18 (450) Tray	4 (1.8)
34140-X06	Under Floor C Support, for 6 (150) Tray	3 (1.4)
34140-X12	Under Floor C Support, for 12 (300) Tray	5 (2.3)

X=finish; 6=Pre-Galvanized, 7=Black. \*Also available in E=Glacier White.

\*\*Available only in Black (-7) and Glacier White (-E).



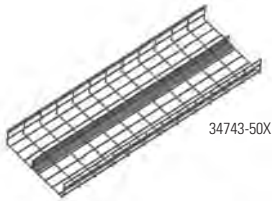

34743-50X

### Cable Tray Divider

Use to divide the internal area of a section of wire mesh cable tray to organize cables by type or zone. Hemmed top edge protects cables. Plain galvanized finish (cannot be painted); includes two 5'L (1.5 m) sections.

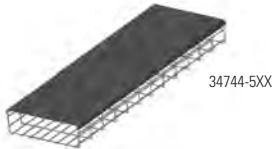

34744-5XX

### Cable Tray Cover

Use to cover the top of a section of wire mesh cable tray to protect or hide cables. Hemmed edges protect the installer. Attaches to the tray with fold-over tabs formed along the edge of the cover; bend the tabs over the top wire on the tray using a flat edge screwdriver. Plain galvanized finish (cannot be painted); includes two 5'L (1.5 m) sections.

### Cable Tray Bottom Insert

Use to cover the bottom of a section of wire mesh cable tray to protect or hide cables. Plain galvanized finish (cannot be painted); includes two 5'L (1.5 m) sections.

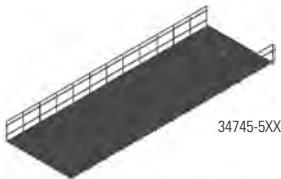

34745-5XX

### Cable Tray Bolt Style Cutting Tool

Use to cut wire mesh cable tray to fit and form pieces to match pathway requirements; angled head allows clear view while cutting.

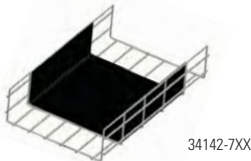

34142-7XX

Part Number	Description H x W x D in (mm)	Shipping Weight lb (kg)
34743-502	Cable Tray Divider, for 2 (50) Tray	3 (1.4)
34743-504	Cable Tray Divider, for 4 (100) Tray	5 (2.3)
34743-506	Cable Tray Divider, for 6 (150) Tray	7 (3.2)
34744-5XX*	Cable Tray Cover	2 (0.9)
34745-5XX*	Cable Tray Bottom Insert	4 (1.8)
34142-7XX**	Cable Tray Liner, for 2 (50) x 8 (200) Tray	1 (0.5)
34144-7XX**	Cable Tray Liner, for 4 (100) x 8 (200) Tray	1 (0.5)
34839-001	Cable Tray Bolt Style Cutting Tool	6 (2.7)

\*P/Ns 34744-5XX and 34745-5XX available in all tray sizes; -504 (4", 100 mm), -506 (6", 150 mm), -508 (8", 200 mm), -512 (12", 300 mm), -516 (16", 400 mm), -518 (18", 450 mm), -520 (20", 500 mm), -524 (24", 600 mm). Shipping weights for 4" Tray.

\*\* Available in all tray sizes. Black polymer material, pre-scored to match tray depth.



34839-001



34741-X01

## Tool-Less Radius Drop

Use to properly support cables as they exit or enter cable tray pathways. Provides a wide radius featuring tool-less attachment that requires no cutting of the tray during installation. Secure cables through slots in the radius drop with cable straps or ties. Attaches to the bottom of the tray with bendable tabs that lock the radius drop in place. Can also be attached to the bottom of the tray with a splice washer from the Splice Washer & Bolt Kit (P/N 34728-X01). Manufactured from steel; sold individually.

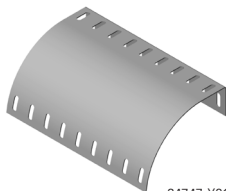

34747-X01

## Large Radius Drop

Use to properly support cables as the cables exit or enter cable tray pathways. Secure cables through slots in the radius drop with cable straps or ties. Attaches to the bottom or side of the tray with two splice washers from the Splice Washer & Bolt Kit (P/N 34728-X01). Manufactured from steel; sold individually.

## Split Bolt Grounding Clamp

Use to attach a ground conductor to wire mesh cable tray. Split bolt attaches over the wires that form the tray. Slot accommodates #6 AWG wire; remove paint from tray for ground contact. Manufactured from bronze alloy and copper, 1.5" L (38 mm).



34838-001

## Label Holder

Use to label a section of wire mesh cable tray to identify the pathway or a drop location. Attaches to the side or bottom of the tray.



34749-001

Part Number	Description	Shipping Weight lb (kg)
34741-X01*	Tool-Less Radius Drop	1 (0.5)
34747-X01*	Large Radius Drop	1 (0.5)
34838-001	Split Bolt Grounding Clamp, Pack of 10	1 (0.5)
34749-001	Label Holder, Pack of 10	1 (0.5)

*X=finish; 5=Zinc, 7=Black. \*Available in Glacier White (-EXX)*

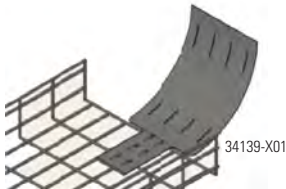

### Vertical Tray Radius Bracket

Use to provide a curved support for cables exiting tray vertically. Attaches to bottom of tray with bendable tabs. Can also attach to bottom of tray with two splice washers (P/N 34728-X01); sold individually.



### Conduit Bracket

Use to attach three conduits, sizes 1/2", 3/4" or 1" (20 mm, 25 mm or 32 mm) to side of tray. Attaches to bottom of tray with bendable tabs. Can also attach to bottom of tray with two splice washers (P/N 34728-X01); sold individually.



### Electrical Box Bracket

Use to attach a single, dual or triple gang junction box to the side of the tray. Attaches with a Clamp Washer (P/N 34746-X01) and Carriage Bolt Hardware (34728-X02); sold individually.



### Auxiliary Side Bracket

Create a physically separate pathway for cable support alongside the tray. Hangs on side of tray, provides a 2" D (50 mm) shelf for cables; sold individually.



### Section Support Bracket

Use to fill the gaps created when cable trays are cut and formed into turns. Hangs on the side of the tray; sold individually.

Part Number	Description Height - in (mm)	Shipping Weight lb (kg)
34139-X01	Vertical Radius Bracket	3 (1.4)
34135-X01	Conduit Bracket	3 (1.4)
34138-X01	Electrical Box Bracket	3 (1.4)
34136-X01	Auxiliary Side Bracket	3 (1.4)
34137-X01	Side Support Bracket, for 2 (50) Tray	2 (0.9)
34137-X02	Side Support Bracket, for 4 (100) Tray	2 (0.9)

*All products listed are available in 6=Pre-Galvanized, 7=Black and E=Glacier White.*



## Runway In A Box

Cable runway is individually packaged to simplify shipping. Individual packaging is utilized for all 10250 Series Universal Cable Runway, 11252 Series TELCO-Style Cable Runway and 11275 Series UL Classified Cable Runway. Individual pieces of runway are packaged in a custom width box of 32 ECT cardboard and banded on our strapping machine. Each box is labeled with the part number and product description, indicating color and width. Pallets are designed to support the full length and width of multiple quantities of runway. Runway is neatly stacked in two or three columns, fully stretch-wrapped and banded to the pallet to eliminate movement during shipping.

## Universal Cable Runway

Our most popular cable runway is designed for value conscious customers. The Universal Cable Runway offers the industry-standard features you have come to expect. With the runway supported every 5' (1.5 m), maximum load with minimal deflection is 132 lb/ft (59.9 kg).

- Made of 3/8" x 1-1/2" x .065" (9.53 mm x 38 mm x 1.65 mm) wall rectangular steel tubing
- Cross members welded at 12" (300 mm) intervals
- Individually boxed to prevent scratches and damage
- Standard length is 9'-11 1/2"/119.5" (3035 mm)
- Underwriters Laboratory Classified for suitability as an equipment grounding conductor only (must remove paint or use ground straps)
- Installation Best Practices includes Runway Elevation Kit

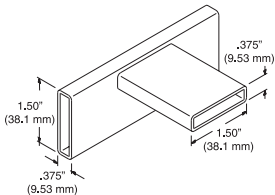

Part Number	Width (Dim. A) in (mm)	Shipping Weight lb (kg)
10250-X04	4 (100)	18 (8.2)
10250-X06	6 (150)	19 (8.6)
10250-X09	9 (230)	20 (9.1)
10250-X12	12 (300)	25 (11.3)
10250-X15	15 (380)	27 (12.2)
10250-X18	18 (460)	29 (13.2)
10250-X24	24 (610)	32 (14.5)
10250-X31	30 (760)	35 (15.7)
10250-X37	36 (910)	38 (17.2)

*X=finish; 1=Gray, 2=Computer Beige, 7=Black, E=Glacier White.*

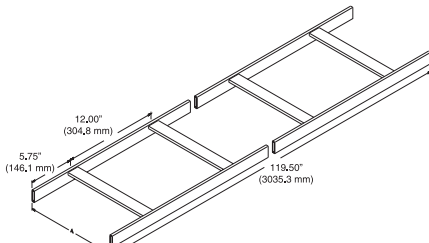

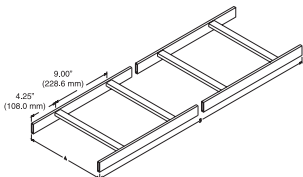
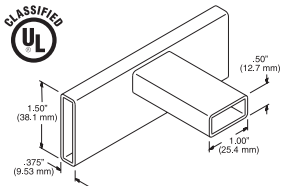

Note: Shown in two sections for illustrative purposes, actual product is one piece.

## TELCO-Style Cable Runway

Similar in construction to our Universal Cable Runway (10250 Series). The side stringers are 1 1/2" x 3/8" x .065" (38 mm x 9.53 mm x 1.65 mm), and the cross members are 1/2" x 1" x .065" (12.7 mm x 30 mm x 1.65 mm), welded at 9" (230 mm) intervals.

- The overall length is 9' 8-1/2" / 116.5" (2959 mm) or 4' 5-1/2" / 53.5" (1359 mm) to comply with TELCO-Style standards
- Individually boxed to prevent scratching and damage
- Installation Best Practices include Runway Elevation Kit

Part Number	Width (Dim. A) in (mm)	Length (Dim. B) in (mm)
11252-X06	6 (150)	9' 8-1/2 (2959)
11252-X09	9 (230)	9' 8-1/2 (2959)
11252-X10	10 (250)	9' 8-1/2 (2959)
11252-X12	12 (300)	9' 8-1/2 (2959)
11252-X13	12 (300)	4' 5-1/2 (1359)
11252-X15	15 (380)	9' 8-1/2 (2959)
11252-X18	18 (460)	9' 8-1/2 (2959)
11252-X20	20 (510)	9' 8-1/2 (2959)

X=finish; 1=Gray, 2=Computer Beige, 7=Black, E=Glacier White.

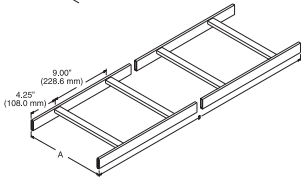
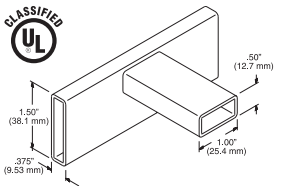

Note: Shown in two sections for illustrative purposes, actual product is one piece.

## UL Classified Cable Runway

Similar in construction to our TELCO Style Cable Runway (11252 series). The side stringers are 1 1/2" x 3/8" x .065" (38.1 mm x 9.53 mm x 1.65 mm), and the cross members are 1/2" x 1" x .065" (12.7 mm x 30 mm x 1.65 mm), welded at 9" (230 mm) intervals.

- Available in Gold chem finish or black chem over zinc plating
- Underwriters Laboratory Classified for suitability (as an equipment grounding conductor only)
- The overall length is 9' 8-1/2" / 116.5" (2959 mm) to comply with TELCO-Style standards
- Individually boxed to prevent scratching and damage
- Installation Best Practices include Runway Elevation Kit

Part Number	Width (Dim. A) in (mm)	Length (Dim. B) in (mm)	Shipping Weight lb (kg)
11275-X06	6 (150)	9' 8-1/2 (2959)	19 (8.6)
11275-X09	9 (230)	9' 8-1/2 (2959)	20 (9.1)
11275-X12	12 (300)	9' 8-1/2 (2959)	22 (10.0)
11275-X15	15 (380)	9' 8-1/2 (2959)	26 (11.8)
11275-X18	18 (460)	9' 8-1/2 (2959)	28 (12.7)
11275-X20	20 (510)	9' 8-1/2 (2959)	29 (13.2)
11275-X24	24 (610)	9' 8-1/2 (2959)	31 (14.1)

X=color over zinc: 0=Gold Chem, 7=Black

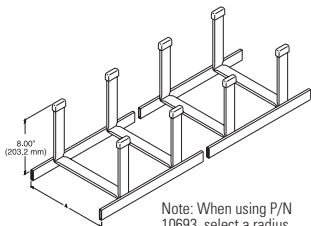
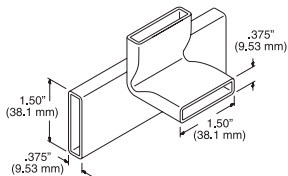

Note: When using P/N 10693, select a radius drop that is less than 7.5"W (191 mm), such as P/N 12101-X03.

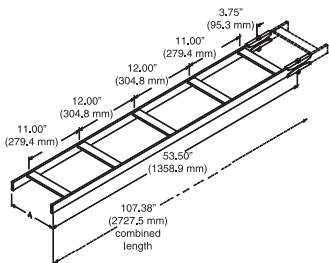

## Trough Cable Runway

Features rubber-capped vertical members on both sides, which form a trough to accommodate larger cable runs. Wall is .065" (1.65 mm) thick.

- Use with heavy-duty splice kits (11299-001, 11298-001)

9' 11-1/2"L/119.5" (3035 mm), 12" (300 mm) Spacing Between Cross Members	
Part Number	Width (Dim. A) in (mm)
10692-X09	9 (230)
10692-110	10 (250)
10692-X12	12 (300)
10692-X15	15 (380)
10692-X18	18 (460)

9' 8-1/2"L/116.5" (2959 mm) , 9" (230 mm) Spacing Between Cross Members	
Part Number	Width (Dim. A) in (mm)
10693-X09	9 (230)
10693-110	10 (250)
10693-X12	12 (300)
10693-X15	15 (380)
10693-X18	18 (460)

X=finish; 1=Gray, 2=Computer Beige, 7=Black, E=Glacier White.

## Quick Ship Cable Runway Kit

The 4' 6" (1359 mm) length of this cable runway is designed to meet UPS requirements without additional charges. Packaged one kit per box.

**Kit consists of:**

- (2) 4' 6"/53.5" (1359 mm) cable runway; combined length is 8' 11 3/8"/107.38" (2727.5 mm)
- (1) Butt-Splice Kit (P/N 11301-001)

Part Number	Width (Dim. A) in (mm)
12170-X06	6 (150)
12170-X09	10 (250)
12170-X12	12 (300)

X=finish; 1=Gray, 2=Computer Beige, 7=Black, E=Glacier White.

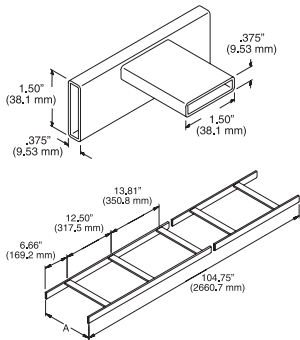

Note: Shown in two sections for illustrative purposes. Actual product is one piece.

## Alternate Space Cable Runway

Designed specifically for use over 19" wide racks (CPI Series 55053, 46353 or 66353) and any 6" W (150 mm) vertical cable manager. A single 104.75" L (2660.7 mm) space will transition a row of four 19" Racks (CPI Series 55053, 46353 or 66353) and five 6" W (150 mm) Vertical Cabling Sections (CPI Series 11729, as shown lower left).

- Runway cross-members are spaced to simplify horizontal to vertical alignment of Cross Member Radius Drops
- Eliminates additional hardware, time-consuming field fabrication and complicated adjustments required with traditional products

Part Number	Width (Dim. A) in (mm)	Shipping Weight lb (kg)
31472-X06	6 (150)	17 (7.7)
31472-X12	12 (300)	24 (10.9)
31472-X18	18 (460)	28 (12.7)
31472-X24	24 (610)	31 (14.1)

X=finish; 1=Gray, 2=Computer Beige, 7=Black, E=Glacier White.

When runway is supported from the ceiling, select a single Radius Drop to match the width of the runway at each transition point. When runway is supported with a Rack-to-Runway Mounting Plate, use two 12100-X06 Radius Drops at each transition point for 12", 18" and 24" W (300 mm, 460 mm and 610 mm) runway.

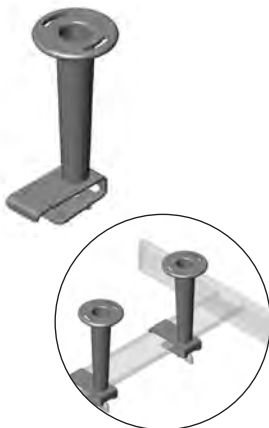

## Cable Runway Pathway Dividers

Pathway Dividers divide Cable Runway into multiple cable pathways in order to organize cables according to media type or destination. By organizing horizontal cables by destination according to route or zone, technicians can better manage cables when additional cables are added or when the cable path through the building changes due to building renovations.

- Cable spools separate cables into individual pathways for better organization of cables
- Spools have a smooth surface to protect cable jackets from damage during installation or maintenance
- Easy installation with included hardware
- Universal/Trough Style Dividers fit 3/8" H x 1-1/2" W (9.53 mm x 38.1 mm) cross members on CPI Universal or Trough Cable Runway
- TELCO/UL Classified Style Dividers fit 1/2" H x 1" W (13 mm x 30 mm) cross members on CPI TELCO or UL Classified Cable Runway

Part Number	Description	Shipping Weight lb (kg)
<b>Universal or Trough Style Dividers</b>		
13392-X11	Divider, Package of 5	1 (0.5)
13392-X12	Divider, Package of 25	3 (1.4)
<b>TELCO or UL Classified Style Dividers</b>		
13392-X21	Divider, Package of 5	1 (0.5)
13392-X22	Divider, Package of 25	3 (1.4)

X=finish; 7=Black, E=Glacier White. Cable spool is black.

## PatchRack For CPI Cable Runway

The PatchRack is a miniature two-post rack that can be attached to CPI Cable Runway to save rack-mount space by placing patch panels or interconnect equipment above the rack or cabinet. Use PatchRack to create a zone network in the data center. Two versions are available; Racks P/N 13395 attach to the Cable Runway side stringer with a 7"D (180 mm) standoff bracket, and Racks P/N 13394 attach to a cross member underneath the Cable Runway. The position of the rack can be adjusted front-to-back or side-to-side. Racks P/N 13395 can also attach perpendicular to Cable Runway that is 12"W (300 mm) or less. Use the Cross Member Hardware Kit P/N 13399-702 for perpendicular mounting of all racks on any width of Cable Runway.

- Attaches to all CPI Cable Runway, but optimized for 1-1/2"H x 3/8"W (38.1 mm x 9.53 mm) side stringers or cross members to Universal Cable Runway
- Supports 19"W rack-mount equipment; supports up to 60 lb (27.2kg)



Part Number	Description	Shipping Weight lb (kg)
13395-X04	With Side Stringer Brackets, 4U	5 (2.3)
13395-X08	With Side Stringer Brackets, 8U	7 (3.2)
13394-X04	With Cross Member Brackets, 4U*	4 (1.8)
13394-X08	With Cross Member Brackets, 8U*	6 (2.7)

*X=*color: 0=Gold, 1=Gray, 2=Computer Beige, 7=Black, E=Glacier White. Gold and Computer Beige kits include gold colored hardware. Gray and Black kits include black colored hardware. Does not include Side Stringer Brackets. \*Attaches to cross-member in parallel orientation only.

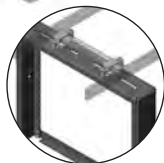

## Accessories For PatchRack

Use Cross Member Hardware Kit for perpendicular mounting on all widths of Cable Runway. The D-Ring Kit provides cable management.

Part Number	Description	Shipping Weight lb (kg)
13399-X02	Cross Member Hardware Kit, Black	1 (0.5)
13396-204	D-Rings for 4U Rack, 6 Rings, Beige	1 (0.5)
13396-208	D-Rings for 8U Rack, 10 Rings, Beige	2 (0.9)
13396-704	D-Rings for 4U Rack, 6 Rings, Black	2 (0.9)
13396-708	D-Rings for 8U Rack, 10 Rings, Black	2 (0.9)

*X=*color: 2=Computer Beige, 7=Black



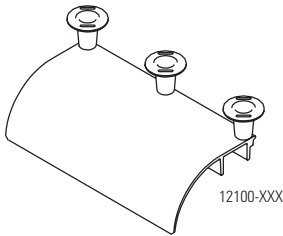

12100-XXX

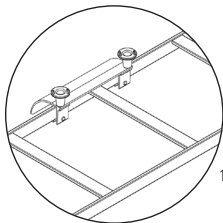

12101-XXX

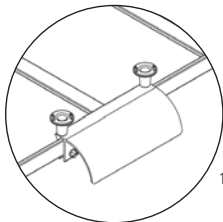

12101-XXX

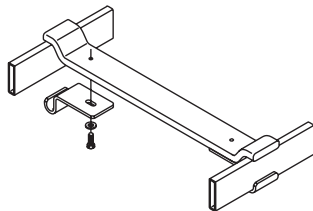

## Cable Runway Radius Drop

Mounts to the side stringer or cross member of CPI Cable Runway to help maintain proper Category 5e/6/6a or fiber bend radius.

- Quick and easy installation
- Cross Member Radius Drop (P/N 12100-XXX) fits 6", 9", 12" and 18"W (150 mm, 230 mm, 300 mm and 460 mm) cross member tubing on CPI Universal Runway (Series 10250)
- Stringer Radius Drop (P/N 12101-XXX) attaches to the side of the runway
- Provides 3" (80 mm) bend radius
- Products 5"W (130 mm), 12100-X06, 12101-X03, drop into CPI's 6"W (150 mm) vertical cabling sections
- Supplied with 1-1/2" (38.1 mm) cable spools (P/N 15003-001) to separate and guide cables
- Sold individually

**Runway Radius Drop, Cross Member**

Part Number	Cable Runway Width - in (mm)	Product Width in (mm)	Cable Spools
12100-X06	6 (150)	5 (130)	2 ea.
12100-X09	9 (230)	8 (200)	2 ea.
12100-X12	12 (300)	11 (280)	3 ea.
12100-X18	18 (460)	17 (430)	3 ea.

**Runway Radius Drop, Stringer, Adjustable**

Part Number	Runway Application	Product Width in (mm)	Cable Spools
12101-X11	Universal	10.3 (260)	2 ea.
12101-X12	Telco	7.8 (197)	2 ea.
12101-X13	Misc.	5 (130)	2 ea.

X=color: 1=Gray, Computer Beige, 7=Black, E=Glacier White.

## Cable Runway Movable Cross Member

Permits the dropping of cables at any point between cross members of 9", 12" or 18"W (230 mm, 300 mm or 460 mm) Cable Runways. Combine with the recommended Cable Runway Radius Drop.

- Fits on standard Cable Runway only — 1-1/2" x 3/8" stringer (38.1 mm x 9.53 mm)
- Can be used as an attachment point for the Cable Runway Radius Drops listed below
- Easy installation using provided hardware

Part Number	Cable Runway in (mm)	Use with Radius Drop
12115-X09	9 (230)	12100-X06
12115-X12	12 (300)	12100-X09
12115-X18	18 (460)	12100-X12

X=color: 1=Gray, 2=Computer Beige, 7=Black, E=Glacier White. Computer Beige kits have gold colored hardware. Gray (-1XX) and Black (-7XX) kits have black colored hardware.

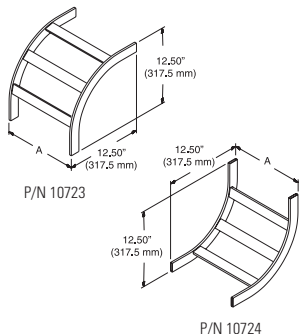

## Cable Runway Radius Bend

Creates a gradual bend for cascading cable runs.

- Made of lightweight 1-1/2" x 3/8" (38.1 mm x 9.53 mm) tubular steel
- Three cross members welded at approximately 23° increments
- Outside/Inside is determined by welding cross members closer to cable side

Part Number		
90° Outside Bend	90° Inside Bend	Width (Dim. A) in (mm)
10723-X04	10724-X04	4 (100)
10723-X06	10724-X06	6 (150)
10723-X08	10714-X08	8 (200)
10723-X09	10724-X09	9 (230)
10723-X10	10724-X10	10 (250)
10723-X12	10724-X12	12 (300)
10723-X15	10724-X15	15 (380)
10723-X18	10724-X18	18 (460)
10723-X20	10724-X20	20 (510)
10723-X24	10724-X24	24 (610)
10723-X31	10724-X31	30 (760)
10723-X37	10724-X37	36 (910)

X=Color; 0=Gold, 1=Gray, 2=Computer Beige, 7=Black, E=Glacier White. Only gold radius bends are UL Classified.

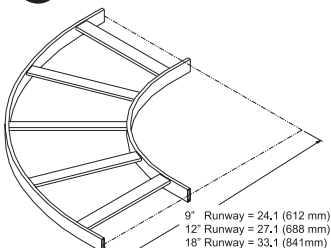

## Cable Runway E-Bend

Creates a 90° gradual sweep in horizontal plane for Cable Runway runs.

Designed for cabling in conformance with minimum bend radius requirements (typically 4 times the cable diameter). Made of lightweight 1-1/2" x 3/8" (38.1 mm x 9.53 mm) tubular steel to fit standard Cable Runway. Cross members welded at approximately 23° increments.

- Conforms to cable bend radius requirements
- Easy installation using CPI Butt-Splices (P/N 11301-001, not included)

Part Number	Cable Runway Width in (mm)	Width (Dim. B) in (mm)
10822-X04	4 (100)	19.1 (485)
10822-X06	6 (150)	21.1 (536)
10822-X08	8 (200)	23.1 (587)
10822-X09	9 (230)	24.1 (612)
10822-X10	10 (250)	25.1 (638)
10822-X12	12 (300)	27.1 (688)
10822-X15	15 (380)	30.1 (765)
10822-X18	18 (460)	33.1 (841)
10822-X20	20 (510)	35.1 (892)
10822-X24	24 (610)	39.1 (993)
10822-X31	30 (760)	45.1 (1146)
10822-X37	36 (910)	51.1 (1298)

X=Color; 0=Gold, 1=Gray, 2=Computer Beige, 7=Black, E=Glacier White. Only gold E-Bends are UL Classified.

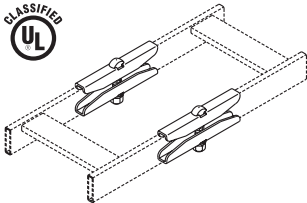

## Butt-Splice Kit

Connect two sections of runway end-to-end. Fits both solid and tubular steel 1-1/2" x 3/8" and 2" x 3/8" (38.1 mm x 9.53 mm and 50.8 mm x 9.53 mm).

**Kit consists of:**

- (4) splice plates
- (2) 3/8-16 trimmed head bolts
- (2) 3/8-16 hex nuts
- (2) 3/8" split lock washers

Part Number	Description in (mm)	Shipping Weight lb (kg)
11301-X01*	Butt-Splice Kit, 1-1/2 x 3/8 (38 x 9.53) Stringer	1 (0.5)
11301-X02*	Butt-Splice Kit, 2 (50.8) Stringer	1 (0.5)
16301-X01*	UL Classified Kit	1 (0.5)

\*X=color over zinc: 0=Gold, 7=Black. Gold kits include gold colored hardware. Black kits include black colored hardware.

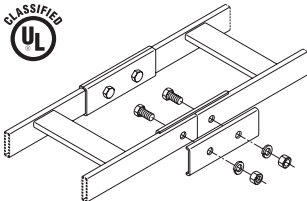

## Heavy-Duty Butt-Splice Kit

For butting two lengths of Runway together. Cable Runway drilling is required.

- Bolt through Butt-Splice Kit for earthquake areas

**Kit consists of:**

- (4) splice plates for 1-1/2" stringers
- (4) 3/8-16 x 1-1/4" hex cap screws
- (4) 3/8-16 hex nuts
- (4) 3/8" split lock washers

Part Number	Description	Shipping Weight lb (kg)
11299-X01*	Heavy-Duty Butt-Splice Kit	2 (0.9)
16299-X01*	UL Classified Butt-Splice Kit	2 (0.9)

\*X=color over zinc: 0=Gold, 7=Black. Gold kits include gold colored hardware. Black kits include black colored hardware.

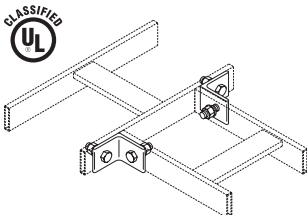

## Heavy-Duty Junction-Splice Kit

Bolt-through Junction-Splice Kit for vertical runs or to meet seismic requirements. Cable Runway drilling is required.

- Material is 2" x 2" x 3/16" (50 mm x 50 mm x 4.763 mm) steel angle

**Kit consists of:**

- (2) splice angles
- (4) 3/8-16 x 1-1/4" hex cap screws
- (4) 3/8-16 hex nuts
- (4) 3/8" split lock washers

Part Number	Description	Shipping Weight lb (kg)
11298-X01*	Heavy-Duty Junction Splice	3 (1.4)
16298-X01*	UL Classified Junction Kit	3 (1.4)

\*X=color over zinc: 0=Gold, 7=Black. Gold kits include gold colored hardware. Black kits include black colored hardware.

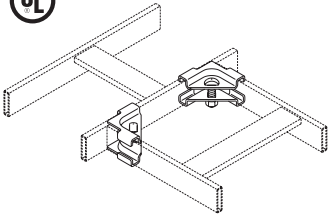

## Junction-Splice Kit

Used to create a 90° junction splice with all types of 1-1/2" x 3/8" or 2" x 3/8" (38.1 mm x 9.53 mm and 50.8 mm x 9.53 mm) Cable Runway.

### Kit consists of:

- (4) corner clamp plates
- (2) 3/8-16 x 1 3/8" trimmed head bolts
- (2) 3/8-16 hex nuts
- (2) 3/8 split lock washers

Part Number	Description in (mm)	Shipping Weight lb (kg)
11302-X01	Junction-Splice Kit 1-1/2 x 3/8 (38mm x 9.53) Stringer	1 (0.5)
11302-X02	Junction-Splice Kit 2 x 3/8 (50.8 x 9.53) Stringer	1 (0.5)
16302-X01	UL Classified Junction Kit	1 (0.5)

X=color over zinc: 0=Gold, 7=Black

Dim A

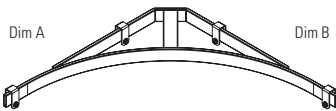

Dim B

Dimension	15" W (380 mm) in (mm)	24" W (610 mm) in (mm)
A	15.48 (393.2)	24.13 (612.9)
B	15.48 (393.2)	24.13 (612.9)

## Cable Runway Corner Bracket

Creates a radius for L, T or X-shaped intersections of Cable Runway formed when two or more pieces of Cable Runway are connected together with the Junction-Splice Kit (P/N 11302 or 16302) or Heavy-Duty Junction-Splice Kit (P/N 11298 or 16298).

- Single-piece welded assembly fabricated from 3/8" x 1-1/2" x .065" (9.53 mm x 38.1 mm x 1.65 mm) wall rectangular steel tubing
- Easy installation; brackets/hardware included

Part Number 15" W (380 mm)	Part Number 24" W (610 mm)	Description
11959-X15	11959-X24	Corner Bracket

X=color over zinc: 0=Gold, 1=Gray, 2=Computer Gray, 7=Black, E=Glacier White.

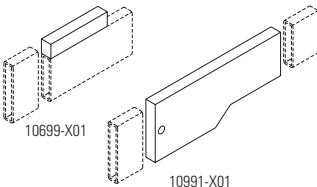

## Transition Adapter Butt-Splice Kits

Enables 1-1/2" x 3/8" (38.1 mm x 9.53 mm) side stringers to be spliced to 2" x 3/8" (50.8 mm x 9.53 mm) side stringers. P/N 10991-001 allows Swivel-Splice Kits to be used with 2" x 3/8" (50.8 mm x 9.53 mm) side stringers.

### Kit 10699-X01 consists of:

- (1) 2" Butt-Splice Kit (P/N 11301-X02)
- (2) steel bars

### Kit 10991-X01 consists of:

- (1) 2" Butt-Splice Kit (P/N 11301-X02)
- (1) 1-1/2" Butt-Splice Kit (P/N 11301-X01)
- (2) Gray or Black finish/color steel transition bars

Part Number	Description in (mm)	Shipping Weight lb (kg)
10699-X01	Adapter Kit, 1-1/2 to 2 (38.1 to 50.8)	2 (0.9)
10991-X01	Transition Kit, 1-1/2 to 2 (38.1 to 50.8)	2 (0.9)

X=color over zinc: 0=Gold, 7=Black

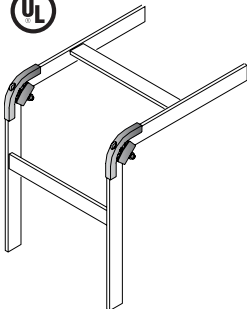

## 90° Runway-Splice Kit

Designed to butt-splice 1-1/2" (38.1 mm) Cable Runway at a 90° angle.

Kit consists of:

- (2) 90° outside clamps
- (2) Inside edge clamps
- (2) 3/8-16 trimmed round head, square neck bolts
- (2) 3/8-16 hex nuts and lock washers

Part Number	Description in (mm)	Shipping Weight lb (kg)
11314-X01	90° Runway-Splice Kit, 1-1/2 x 3/8 (38.1 x 9.53) stringer	1 (0.5)
16314-X01	UL Classified Kit	1 (0.5)

X=color over zinc: 0=Gold, 7=Black

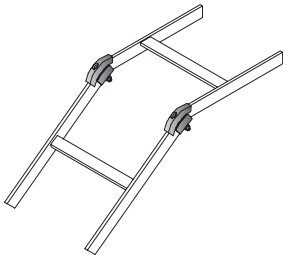

## 45° Runway-Splice Kit

Butt-splices Cable Runway at a 45° angle.

Kit consists of:

- (2) 45° outside clamps
- (2) Inside edge clamps
- (2) 3/8-16 trimmed round head, square neck bolts
- (2) 3/8-16 hex nuts and lock washers

Part Number	Description in (mm)	Shipping Weight lb (kg)
11313-X01	45° Runway-Splice Kit, 1-1/2 x 3/8 (38.1 x 9.53) stringer	1 (0.5)
16313-X01	UL Classified Kit	1 (0.5)

X=color over zinc: 0=Gold, 7=Black

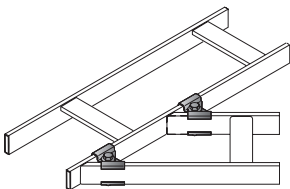

## Adjustable Junction-Splice Kit

Adjusts to form any junction angle for cabling that requires a large radius bend or to route around existing plumbing, electrical, etc.

**Kit consists of:**

- (4) adjustable corner plates
- (2) 3/8-16 x 2" hex cap screws
- (2) 3/8-16 hex nuts
- (2) 3/8 lock washers

*Note: Requires one kit to attach one end of cable runway.*

Part Number	Description in (mm)	Shipping Weight lb (kg)
10616-X01	Adjustable Junction Splice Kit	2 (0.9)

X=color over zinc: 0=Gold, 7=Black

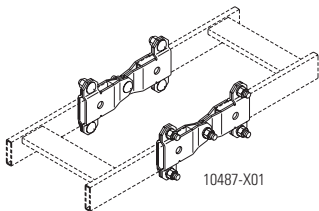

## Swivel Splice Kits

Splices cable runway vertically, horizontally or perpendicularly. Adjusts to any angle, not limited to 45° or 90°. Flexible swivel design simplifies Cable Runway installation by making it easier to route around existing plumbing, electrical, etc. Material is steel. Hardware and instructions are included.

### Butt Swivel (10487) Kit consists of:

- (8) bracket end
- (8) 5/16-18 x 3/4" round head square, neck bolts
- (2) 5/16-18 x 1" round head square, neck bolts
- (10) 5/16-18 hex nuts, split lock washers

### Junction Swivel (10488) Kit consists of:

- (4) bracket end
- (2) bracket supports and plate clamps
- (2) 5/16-18 x 1" round head square, neck bolts
- (8) 5/16-18 x 3/4" round head square, neck bolts
- (10) 5/16-18 hex nuts, split lock washers

### Vertical Swivel (10489) Kit consists of:

- (4) bracket end
- (2) bracket clamps and plate clamps
- (2) 5/16-18 x 1" round head, square neck bolts
- (6) 5/16-18 x 3/4" round head, square neck bolts
- (8) 5/16-18 hex nuts, split lock washers

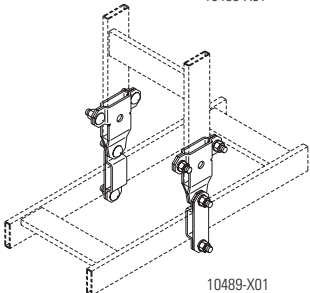
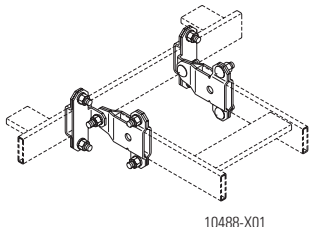

Part Number	Description	Shipping Weight lb (kg)
10487-X01	Butt-Swivel Splice Kit	1 (0.5)
10488-X01	Junction Swivel Splice Kit	1 (0.5)
10489-X01	Vertical Swivel Splice Kit	1 (0.5)
16487-X01	UL Classified Butt Swivel Splice Kit	1 (0.5)
16488-X01	UL Classified Junction Swivel Splice Kit	1 (0.5)
16489-X01	UL Classified Vertical Swivel Splice Kit	1 (0.5)

X=color over zinc: 0=Gold, 7=Black

## 3" (80 mm) Channel Rack-To-Runway Mounting Plate

Secures Cable Runway to the top of Standard and Universal Racks. Mounts either parallel or perpendicular. For proper attachment of 6"W (150 mm) Cable Runway, specify a rack with top bars instead of top angles.

- Material is 1/4" (6.4 mm) thick cold-rolled steel. Installation Best Practices include Runway Elevation Kit (P/N 10506-XXX)

**P/N 10595-XXX consists of:**

- (1) mounting plate
- (4) 5/16-18 x 2 1/4" J-bolts
- (4) 5/16-18 hex nuts
- (4) 5/16 split lock washers

**P/N 12408-X24 consists of:**

- (1) mounting plate
- (2) 5/16-18 x 3 1/4" J-bolts
- (2) 5/16-18 x 2 1/4" J-bolts
- (4) 5/16-18 hex nuts
- (4) 5/16 split lock washers

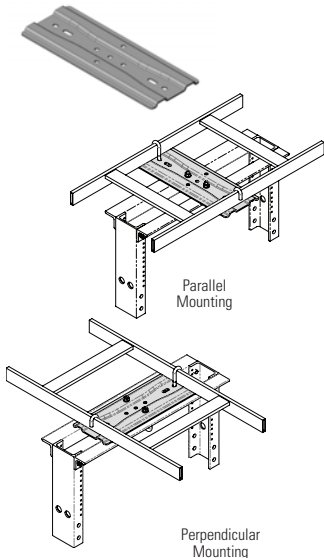

Part Number	Runway Width in (mm)	Plate Material	Shipping Weight lb (kg)
10595-X04	4 (100)	Steel	4 (1.8)
10595-X08	5 to 8 (130 to 200)	Steel	5 (2.3)
10595-X12	9 to 12 (230 to 300)	Steel	5 (2.3)
10595-X18	15 to 18 (380 to 460)	Steel	7 (3.2)
12408-X24	20 to 24 (510 to 610)	Aluminum	4 (1.8)

*X=*color: 1=Gray, 2=Computer Beige, 7=Black, E=Glacier White. Gold and Glacier White kits have gold colored hardware. Gray and Black kits have black colored hardware.

## 3" (80 mm) Channel Rack-To-Runway Mounting Plate With Bracket

Secures Runway to the top of Universal Rack without intruding into mounting space. The combination of the flat plate and hat-shaped bracket form a clamp around the rack's top angles or top bars. Mounts parallel or perpendicular. For proper attachment of 6" runway, use top bars (13045 Series) rather than top angles. Installation Best Practices include Runway Elevation Kit (P/N 10506)

**Kit consists of:**

- (1) mounting plate
- (2) hat-shaped brackets
- (2) J-Bolts, 5/16-18 x 2-1/4"
- (3) hex nuts, 5/16-18
- (3) split lock washers, 5/16"

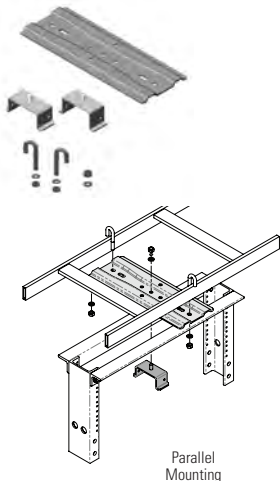

Part Number	Runway Width in (mm)	Plate Material	Shipping Weight lb (kg)
12730-X04	4 (100)	Steel	4 (1.8)
12730-X08	5 to 8 (130 to 200)	Steel	5 (2.3)
12730-X12	9 to 12 (230 to 300)	Steel	5 (2.3)
12730-X18	15 to 18 (380 to 460)	Steel	7 (3.2)
13730-X24	20 to 24 (510 to 610)	Aluminum	4 (1.8)

*X=*color: 1=Gray, 2=Computer Beige, 7=Black, E=Glacier White. Gold and Glacier White kits have gold colored hardware. Gray and Black kits have black colored hardware.

## 6" (150 mm) Channel Rack-To-Runway Mounting Plate

Secures Cable Runway to the top of 6"D (150 mm) Standard Rack. Mounts either parallel or perpendicular to runway.

• Installation Best Practices include Runway Elevation Kit (P/N 10506-XXX)

**P/N 12121-XXX consists of:**      **P/N 12409-X24 consists of:**

- (1) mounting plate
- (4) 5/16-18 x 2 1/4" J-bolts
- (4) 5/16-18 hex nuts
- (4) 5/16 split lock washers
- (1) mounting plate
- (2) 5/16-18 x 3 1/4" J-bolts
- (2) 5/16-18 x 2 1/4" J-bolts
- (4) 5/16-18 hex nuts

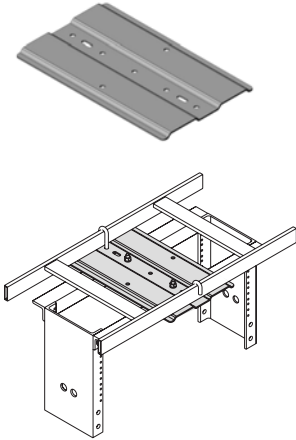

Part Number	Runway Width in (mm)	Plate Material	Shipping Weight lb (kg)
12121-X09	5 to 9 (130 to 230)	Aluminum	5 (2.3)
12121-X12	9 to 12 (230 to 300)	Aluminum	5 (2.3)
12121-X18	15 to 18 (380 to 460)	Aluminum	7 (3.2)
12409-X24	20 to 24 (510 to 610)	Aluminum	5 (2.3)

*X=*color: 1=Gray, 2=Computer Beige, 7=Black, E=Glacier White. Gold and Glacier White kits have gold colored hardware. Gray and Black kits have black colored hardware. 12409-X24 adds 1.25" (32 mm) to height of rack.

## 6" (150 mm) Channel Rack-To-Runway Mounting Plate With Bracket

Secures Cable Runway to the top of 6"D (150 mm) Standard Rack without intruding into valuable mounting space. The combination of the flat plate and hat-shaped bracket form a clamp around the rack's top angles or top bars. Mounts either parallel or perpendicular.

• Installation Best Practices include Runway Elevation Kit (P/N 10506-XXX)

**Kit consists of:**

- (1) mounting plates
- (2) hat-shaped bracket
- (2) J-Bolts, 5/16-18 x 2-1/4"
- (3) hex nuts, 5/16-18
- (3) split lock washers, 5/16"

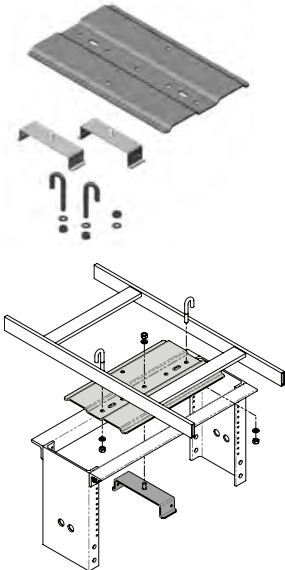

Part Number	Runway Width in (mm)	Plate Material	Shipping Weight lb (kg)
12731-X09	5 to 9 (130 to 230)	Aluminum	5 (2.3)
12731-X12	9 to 12 (230 to 300)	Aluminum	5 (2.3)
12731-X18	15 to 18 (380 to 460)	Aluminum	7 (3.2)
13731-X24	20 to 24 (510 to 610)	Aluminum	5 (2.3)

*X=*color: 1=Gray, 2=Computer Beige, 7=Black, E=Glacier White. Gold and Glacier White kits have gold colored hardware. Gray and Black kits have black colored hardware. 13731-X24 adds 1.25" (32 mm) to height of rack.



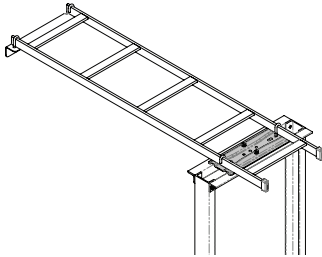

Rack Not Included

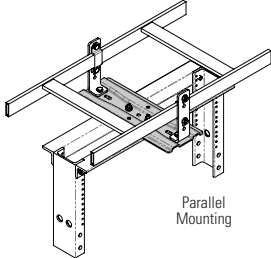
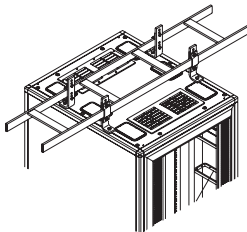

Parallel Mounting

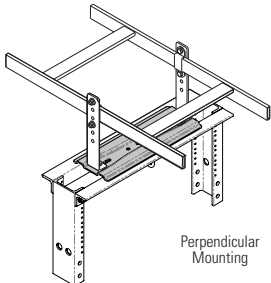

Perpendicular Mounting

## Cable Runway Wall To Rack Kit

The CPI Cable Runway Wall To Rack Kit is a one part number solution to the problem of providing support for cable between the rack and the wall.

Kit consists of:

- (1) 4' 6"L/54" (1370 mm) Universal Cable Runway
- (1) Wall angle support bracket
- (1) Rack to runway mounting plate
- (1) Pair of end caps
- (6) J-bolts

*Note: The kit is available with runway that is 6", 9" or 12"W (150 mm, 230 mm or 300 mm). Rack is not included.*

Part Number	Description	Shipping Weight lb (kg)
<b>Standard/Universal Racks with 3"D (80 mm) Mounting Channels Width - in (mm)</b>		
11911-X06	6 (150) Cable Runway Wall to Rack Kit	24 (10.9)
11911-X09	9 (230) Cable Runway Wall to Rack Kit	28 (12.7)
11911-X12	12 (300) Cable Runway Wall to Rack Kit	32 (14.5)
<b>Standard Rack with 6"D (150 mm) Mounting Channels Width - in (mm)</b>		
31473-X06	6 (150) Cable Runway Wall to Rack Kit	17 (7.7)
31473-X09	9 (230) Cable Runway Wall to Rack Kit	19 (8.6)
31473-X12	12 (300) Cable Runway Wall to Rack Kit	24 (10.9)

*X=*color: 1=Gray, 2=Computer Beige, 7=Black, E=Glacier White. Gold and Glacier White kits have gold colored hardware. Gray and Black kits have black colored hardware.

## Cable Runway Elevation Kit

Supports Cable Runway above a continuous row of CPI Racks or Cabinets of varying heights and provides additional space between the tops of the racks or cabinets and the cable runway, which can create smoother transition of cables.

- Three ranges of incremental elevation
- Can be mounted perpendicular or parallel
- Rack kit includes a single pair of brackets and assembly hardware
- Rack kits attach to the top of the rack with a Rack-To-Runway Mounting Plate (P/N 10595 or 12121, sold separately)
- Cabinet kits include two pairs of brackets and assembly hardware
- Cabinet kits attach directly to the top of the cabinet

Rack	Shipping Weight lb (kg)	Cabinet	Shipping Weight lb (kg)
<b>2", 2.5" or 3"H (50 mm, 64 mm or 80 mm) Elevation</b>			
10506-X02	2 (0.9)	10506-X12	2 (0.9)
<b>4", 5" or 6"H (100 mm, 130 mm or 150 mm) Elevation</b>			
10506-X06	3 (1.4)	10506-X16	5 (2.3)
<b>10", 11" or 12"H (250 mm, 280 mm or 300 mm) Elevation</b>			
10506-X08	2 (0.9)	10506-X18	4 (1.8)

*X=*color: 1=Gray, 2=Computer Beige, 7=Black, E=Glacier White. Gold and Glacier White kits have gold colored hardware. Gray and Black kits have black colored hardware.

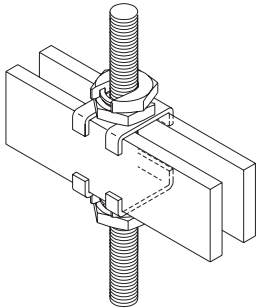

## Slip-On® Framing Clip, Cable Runway

Allows easy installation of additional rack grids to existing grids by slipping clamps around 5/8" threaded rod.

- Material is steel finished with gold over zinc plating

### Kit consists of:

- (2) slotted clamps
- (2) 5/8" Slip-On® Lock Nuts

*Slip-On® is a registered trademark of Slip-On Lock Nut Co.*

Part Number	Description in (mm)	Shipping Weight lb (kg)
11019-001	For 3/8 (9.53) Bar or Runway Stringer, 5/8" threaded rod	2 (0.9)
11019-002	For 9/16 (14.288) channel, 5/8" threaded rod	2 (0.9)

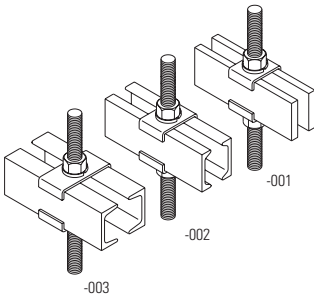

## Framing Clip Kit, Cable Runway

Creates a rigid connection between two adjacent grid or cable runway sections.

- Material is steel finished with gold over zinc plating; kit consists of 2 brackets only

### Installation will require:

- (1) 5/8-11 or 1/2-13 threaded rod (of appropriate length)
- (2) 5/8-11 or 1/2-13 hex nuts
- (2) 5/8" or 1/2" split lock washers

Part Number	Description in (mm)	Shipping Weight lb (kg)
<b>5/8" Bolt Size</b>		
10609-001	For 3/8 (9.53) Bar or Runway Stringer	1 (0.5)
10609-002	For 9/16 (14.288) Channel	1 (0.5)
10609-003	For 1 (30) Channel	1 (0.5)
<b>1/2" Bolt Size</b>		
10621-001	For 3/8 (9.53) Bar or Runway Stringer	1 (0.5)
10621-002	For 9/16 (14.288) Channel	1 (0.5)
10621-003	For 1 (30) Channel	1 (0.5)

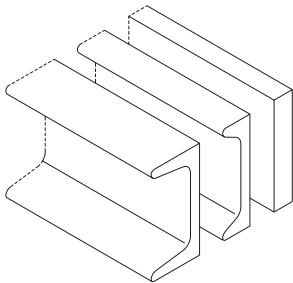

## Auxiliary Framing Channel, Cable Runway

• Steel channel or bar commonly used as auxiliary framing for Cable Runways

Part Number	Description in (mm)	Length ft (m)	Shipping Weight lb (kg)
11450-X01	1 x 2 x 3/15 (25 x 50 x 4.763) Channel	10 (3)	24 (10.9)
10745-X06	3/8 x 2 (9.53 x 50) Bar	6 (1.8)	14 (6.4)
10628-X02	9/16 x 2 x 3/16 (14.228 x 50 x 4.763) Channel	10 (3)	17 (7.7)

X=color: 1=Gray, 2=Computer Beige, 7=Black.

## Heavy-Duty, Auxiliary Framing Channel Splice, Cable Runway

Provides extra strength to butt-splice framing channel.

- Drilling the framing channel is required
- Color is gray splice bars with gold hardware

**Kit consists of:**

- (1) channel splice, 6" L (150 mm)
- (1) steel bar splice, 6" L (150 mm)
- (4) 1/2-13 hex cap screws
- (4) 1/2-13 hex nuts and split lock washers

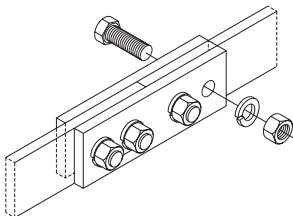
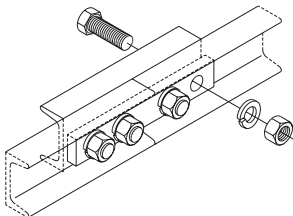
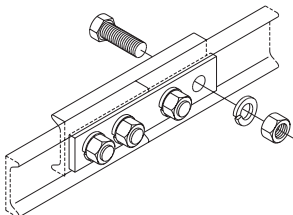

Part Number	Description in (mm)	Figure	Shipping Weight lb (kg)
10746-101	9/16 x 2 (14.288 x 50) Channel	A	3 (1.4)
10747-101	1 x 2 (25 x 50) Channel	B	3 (1.4)

## Auxiliary Framing Bar Splice Kit, Cable Runway

Butt-splices 3/8" x 2" (9.53 mm x 50 mm) Auxiliary Framing Bar.

- Drilling the framing bar is required
- Material is steel bar 1/4" x 2" x 6" L (6.4 mm x 50 mm x 150 mm)
- Color is gray with gold hardware

**Kit consists of:**

- (2) splice bars
- (4) 1/2-13 hex cap screws
- (4) 1/2-13 hex nuts and split lock washers

Part Number	Description in (mm)	Figure	Shipping Weight lb (kg)
10748-101	Bar Splice Kit	C	4 (1.8)

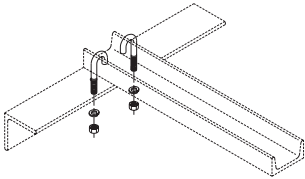

## J-Bolt Kit, Auxiliary Framing Channel/Wall Angle Support

Used to attach a 2" x 1" (50 mm x 30 mm) auxiliary framing channel to a wall angle support.

- Finish is gold over zinc plating

**Kit consists of 2 each:**

- 1/4-20 x 1-3/4" J-Bolts
- 1/4-20 hex nuts
- 1/4 split lock washers

Part Number	Description	Shipping Weight lb (kg)
11303-000	J-Bolt Kit	1 (0.5)

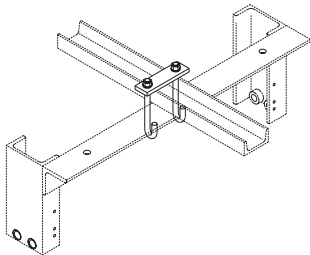

## J-Bolt Kit, Auxiliary Framing Channel/Rack Top Bar

Used to attach a 2" x 1" (50 mm x 30 mm) auxiliary framing channel to a 1 1/2" (38 mm) equipment rack top bar.

- Finish is gold over zinc plating

**Kit consists of:**

- (1) 1/4" x 1" x 3-1/2" (6.4 mm x 30 mm x 89 mm) cold-rolled steel plate
- (2) 5/16-18 x 3-1/4" J-Bolts
- (2) 5/16-18 hex nuts and split lock washers

Part Number	Description	Shipping Weight lb (kg)
11305-000	J-Bolt Kit	1 (0.5)

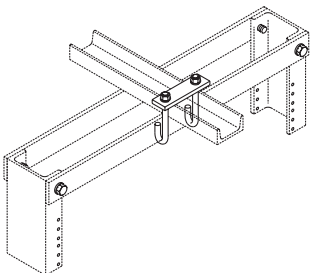

## J-Bolt Kit, Auxiliary Framing Channel/Rack Top Angle

Used to attach a 2" x 1" (50 mm x 30 mm) auxiliary framing channel to a 2" x 2" (50 mm x 50 mm) equipment rack top angle.

- Finish is gold over zinc plating

**Kit consists of:**

- (1) 1/4" x 1" x 3-1/2" (6.4 mm x 30 mm x 89 mm) cold-rolled steel plate
- (2) 5/16-18 x 3-3/4" J-Bolts
- (2) 5/16-18 hex nuts and split lock washers

Part Number	Description	Shipping Weight lb (kg)
11304-000	J-Bolt Kit	1 (0.5)

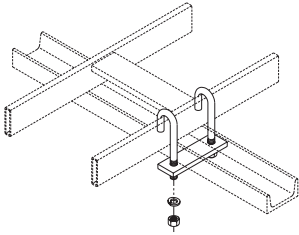

## J-Bolt Kit, Auxiliary Framing Channel/Runway

Used to attach 1-1/2" (38 mm) Cable Runway to a 1" x 2" (30 mm x 50 mm) auxiliary framing channel without drilling.

- Gold over zinc plating

### Kit consists of:

- (1) 1/4" x 1" x 3-1/2" (6.4 mm x 30 mm x 89 mm) cold-rolled steel plate
- (2) 5/16-18 x 3-1/4" J-Bolts
- (2) 5/16-18 hex nuts, split lock washers

Part Number	Description in (mm)	Shipping Weight lb (kg)
11306-001	For 1-1/2 (38) Side Stringers	1 (0.5)
11306-002	For 2 (50) Side Stringers	1 (0.5)

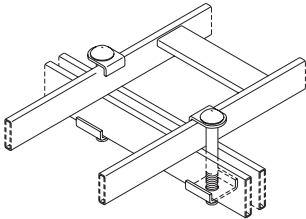

## J-Bolt Clip Kit, Auxiliary Framing Channel/Cable Runway

For fastening Cable Runway to auxiliary framework. Material is steel finished with gold over zinc plating.

### Kit consists of:

- (2) Clip J-Bolt
- (2) 1/2-13 split lock washer
- (2) 1/2-13 hex nut

Part Number	Description in (mm)	Shipping Weight lb (kg)
10635-003	For 3/8 x 2 (9.53 x 50) Bar	1 (0.5)
10635-005	For 9/16 x 2 (14.288 x 50) Channel	1 (0.5)
10635-007	For 1 x 2 (30 x 50) Channel	1 (0.5)

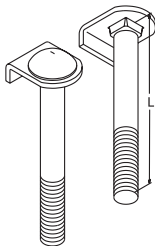

## Clip J-Bolt, Auxiliary Framing Channel/Cable Runway

Used to attach Cable Runway to auxiliary framing.

- Sold individually
- Gold over zinc plating

### Kit consists of:

- (1) 1/2-13 lock nut
- (1) 1/2 Split lock washer

Part Number	Description Nominal Size and Length	Shipping Weight lb (kg)
10620-003	1/2-13 x 4-3/8"	1 (0.5)
10620-004	1/2-13 x 4-7/8"	1 (0.5)

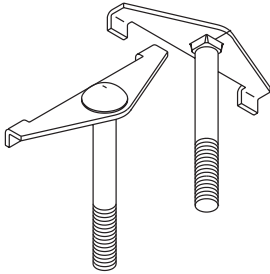

## Spanner Kit, Auxiliary Framing Channel/Cable Runway

Used to attach Cable Runway to auxiliary framing.

- Gold over zinc plating, sold individually

**Kit consists of:**

- (1) Spanner Bolt
- (1) 1/2-13 split lock washer
- (1) 1/2-13 hex nut

Part Number	Description Nominal Size and Length	Shipping Weight lb (kg)
10702-001	1/2-13 x 4-3/8"	1 (0.5)
10702-002	1/2-13 x 4-7/8"	1 (0.5)

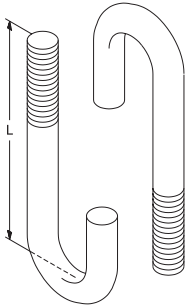

## J-Bolts (Hook Bolt, Round Bend), Auxiliary Framing Channel/Cable

Used to bolt Cable Runway (11431 series only), auxiliary framing channels and/or bars together.

- Gold over zinc and black zinc plate finish
- Includes nut and split lock washer
- Commercial grade, kits sold individually

Part Number	Nominal Size	Length	Opening	Shipping Weight lb (kg)
11430-X01	1/4-20	1 3/4"	7/32	1 (0.5)
11430-X02	1/4-20	2"	7/32	1 (0.5)
11431-X01	5/16-18	2 1/4"	7/16	1 (0.5)
11431-X02	5/16-18	2 3/4"	7/16	1 (0.5)
11431-X03	5/16-18	3 1/4"	7/16	1 (0.5)
11431-X04	5/16-18	3 3/4"	9/32	1 (0.5)
11431-X05	5/16-18	3 3/4"	7/16	1 (0.5)
11431-X06	5/16-18	6 1/2"	7/16	1 (0.5)

X=Color: 0=Gold, 7=Black

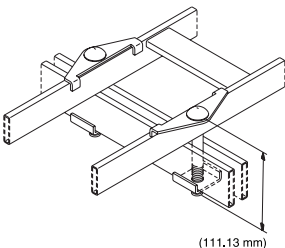

## Mounting Kit, Auxiliary Framing Channel

For fastening Cable Runway to auxiliary framework. Material is steel finished with gold over zinc plating.

Part Number	Description in (mm)	Shipping Weight lb (kg)
10709-001	For 3/8 x 2 (9.53 x 50) Bar, Pair	1 (0.5)
10709-003	For 9/16 x 2 (14.288 x 50) Channel, Pair	1 (0.5)
10709-005	For 1 x 2 (30 x 50) Channel, Pair	1 (0.5)

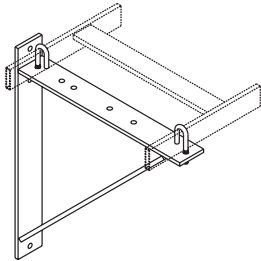

## Triangular Support Bracket, Aluminum

Triangular Support Bracket provides wall support for Cable Runway. Made of 1/4" x 2" (6.4 mm x 50 mm) aluminum bar. Load rating is 100 lb (45.4 kg).

**Kit consists of:**

- (1) triangular bracket
- (2) 5/16-18 x 2 1/4" J-bolts
- (2) 5/16-18 hex nuts & 5/16 lock washers

Part Number	Runway Widths in (mm)	Shipping Weight lb (kg)
11312-X06	4-6 (100 - 150)	2 (0.9)
11312-X12	6-12 (150 - 300)	3 (1.4)
11312-X18	12-18 (300 - 460)	3 (1.4)

*X=*color: 1=Gray, 2=Computer Beige, 7=Black, E=Glacier White.

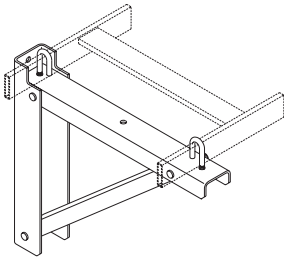

## Triangular Support Bracket, Steel

Triangular Support Bracket provides wall support for cable runway. Made of cold-rolled steel. Load rating is 400 lb (181.4 kg).

**Kit consists of:**

- (1) vertical wall-mounting bracket
- (1) runway support channel
- (1) angle support channel
- (3) clevis pins (5/16" diameter) & cotter pins
- (2) 5/16-18 x 2 1/4" J-bolts
- (2) 5/16-18 hex nuts & 5/16 lock washers

Part Number	Runway Widths in (mm)	Shipping Weight lb (kg)
11746-X12	4-12 (100-300)	5 (2.3)
11746-X18	9-18 (230-460)	8 (3.6)
11746-X24	9-24 (230-610)	9 (4.1)

*X=*color: 0=Gold, 1=Gray, 2=Computer Beige, 7=Black, E=Glacier White. Gold and Glacier White kits have gold colored hardware. Gray and Black kits have black colored hardware.

## Wall Angle Support Kit, Cable Runway

2" x 2" x .105" (50 mm x 50 mm x 2.67 mm) steel support angle is designed for wall-mounting specific widths of Cable Runway.

### Kit consists of:

- (1) wall angle
- (2) 5/16-18 x 2 1/4" J-bolts
- (2) 5/16-18 hex nuts
- (2) 5/16 lock washers

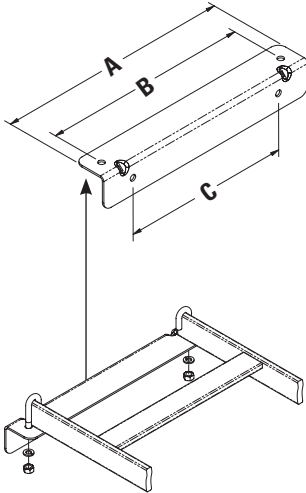

### 11421 Wall Angle Support Kit

Color	
1	Gray
2	Computer Beige
7	Black
0	Gold
E	Glacier White

	Runway Width in (mm)	Dim. A in (mm)	Dim. B in (mm)	Dim. C in (mm)
04	4 (100)	6 (150)	4.31 (109.5)	4.31 (109.5)
06	6 (150)	8 (200)	6.31 (160.3)	4 (100.0)
09	9 (230)	11 (280)	9.31 (236.5)	7 (180.0)
10	10 (250)	12 (300)	10.21 (261.9)	8 (200.0)
12	12 (300)	14 (360)	12.31 (312.7)	10 (250.0)
15	15 (380)	17 (430)	15.31 (388.9)	13 (330.0)
18	18 (460)	20 (510)	18.31 (465.1)	16 (410.0)
20	20 (510)	22 (560)	20.31 (515.9)	18 (460.0)
24	24 (610)	26 (660)	24.31 (617.5)	22 (460.0)
30	30 (760)	32 (810)	30.31 (769.9)	28 (710.0)

11421 - X XX

Gold and Glacier White kits have gold colored hardware. Gray and Black kits have black colored hardware.

## Cable Runway Standoff Support Kit

Allows the attachment of cable runway 12" (300 mm) directly above and either parallel or perpendicular to existing Cable Runway. Each kit consists of the following items: two steel angle pieces, four steel brackets and eight sets of nuts, bolts and washers. The angle pieces are available in Gray, Beige, Black or Gold finish.

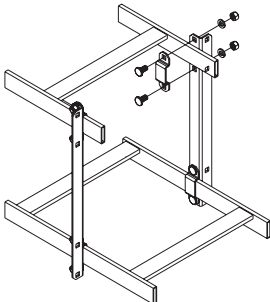

Part Number	Description	Shipping Weight lb (kg)
31470-X12	Standoff Support Kit	1 (0.5)

X=color: 0=Gold, 1=Gray, 2=Computer Beige, 7=Black, E=Glacier White. Gold, Glacier White and Computer Beige kits have gold-colored hardware. Gray and Black kits have black color hardware.



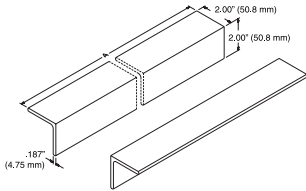

## Wall Angle, Cable Runway

Steel angles used as a wall support or as part of earthquake bracing.

- Material is 2" x 2" x 3/16" (50 mm x 50 mm x 4.763 mm) steel
- Color used is Gray (other colors available)
- Wall angle is not pre-drilled

Part Number	Dimension A ft (m)	Shipping Weight lb (kg)
11420-101	1 (0.3)	3 (1.4)
11420-104	4 (1.2)	7 (3.2)
11420-108	8 (2.4)	20 (9.1)
11420-110	10 (3.0)	23 (10.4)

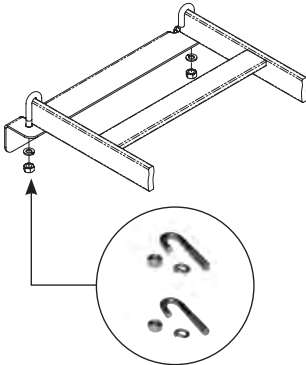

## J-Bolt Kit, Cable Runway

To attach Cable Runway to Wall Angle Support, a Wall Support Bracket or to a MegaFrame® Cabinet.

**Kit (wall angle/support) consists of:**

- (2) 5/16-18 x 2-1/4" J-bolts (11431-001)
- (2) 5/16-18 hex nuts
- (2) 5/16 split lock washers

**MegaFrame kit consists of:**

- (4) 5/16-18 x 3-1/4" J-bolts
- (4) 5/16" split lock washers
- (4) 5/16-18 hex nuts

Part Number	Description	Shipping Weight lb (kg)
11308-X01	J-Bolt Kit	1 (0.5)
11308-X05	J-Bolt Kit, MegaFrame	1 (0.5)

X=color: 0=Gold, 7=Black

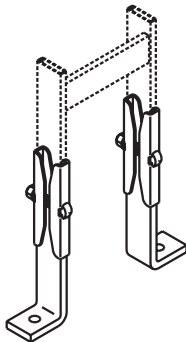

## Foot Kit, Cable Runway

To attach and secure Cable Runway to a wall or floor. Foot made of 3/8" x 1-1/2" x 6"H (9.53 mm x 38 mm x 150 mm) steel.

**Kit consists of:**

- (2) cable rack feet
- (4) splice plates
- (2) 3/8-16 x 2 1/4" trimmed round head square neck bolts
- (2) 3/8-16 hex nuts
- (2) 3/8" lock washers

Part Number	Description	Shipping Weight lb (kg)
11309-X01	Foot Kit	4 (1.8)

X=color: 0=Gold, 1=Gray, 2=Computer Beige, 7=Black, E=Glacier White. Gold and Glacier White kits have gold colored hardware. Gray and Black kits have black colored hardware.

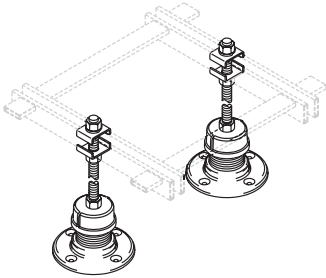

## Adjustable Floor Support Stands, Cable Runway

Use for floor support for cable runway grids.

- Sold in pairs
- Design allows mounting of any width cable runway
- Heights from 5" to 10" (130 mm to 250 mm)
- Should be securely fastened to floor

**Kit consists of:**

- (2) 2" pipe caps
- (2) floor flanges
- (2) 2" pipe
- (4) grid clamps
- (2) spacers, 3/8" x 1.5"
- (2) 5/8-11 threaded rod
- (2) 5/8 lock washers
- (6) 5/8-11 nuts

Part Number	Height in (mm)
11235-X01	5 to 6 (130 to 150)
11236-X01	6 to 8 (150 to 200)
11237-X01	8 to 10 (200 to 300)

X=color: 1=Gray, 2=Computer Beige, 7=Black, E=Glacier White.

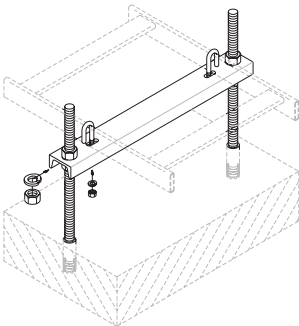

1/2 Pair Shown

## Adjustable Floor Support Channel, Cable Runway

Use for floor support of Cable Runway.

- Sold in pairs
- Cable Runway height adjustable from 3" to 8" (80 mm to 200 mm)
- Must be securely fastened to floor with 5/8" rods and anchors (included)

Part Number	Runway Width in (mm)
11241-X12	12 (300)
11241-X15	15 (380)
11241-X18	18 (460)

X=color: 1=Gray, 2=Computer Beige, 7=Black, E=Glacier White. To install the anchors, use the specially designed anchor setting tool (P/N 06003-001); sold separately.

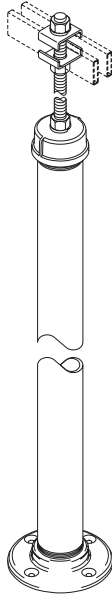

## Tall Pipe Stand, Cable Runway

Supports auxiliary framing or Cable Runway from the floor.

- Material is steel

### Kit consists of:

- (1) floor flange
- (1) appropriate length of 2" (50 mm) pipe
- (1) pipe cap, center drilled and tapped for a 5/8- 11 threaded rod (P/N 11440, not included)
- (3) 5/8-11 hex nuts
- (3) 5/8 split lock washers
- (4) 1/4-20 x 1 1/2" studs
- (4) 1/4-20 concrete anchors
- (4) 1/4-20 hex nuts
- (4) 1/4 Type B washers

### Installation also requires:

- (1) grid clamp of appropriate width, See P/N 10609
- (1) 5/8-11 threaded rod of appropriate length, See P/N 11440

*Note: Must be securely mounted to floor with included anchor kit.*

*Also, in the case of attachment to Cable Runway, you may need to use Runway Support Brackets, series 11408 or 10607.*

Part Number	Description in (mm)	Overall Height ft (m)	Shipping Weight lb (kg)
10684-X01	2 x 79 (50 x 2010) Tall Pole	7 (2.1)	16 (7.3)
10684-X02	2 x 85 (50 x 2160) Tall Pole	7.6 (2.3)	18 (8.2)
10684-X03	2 x 91 (50 x 2310) Tall Pole	8 (2.4)	20 (9.1)
10684-X04	2 x 103 (50 x 2620) Tall Pole	9 (2.7)	24 (10.9)

*X=color: 1=Gray, 2=Computer Beige, 7=Black, Glacier White.*

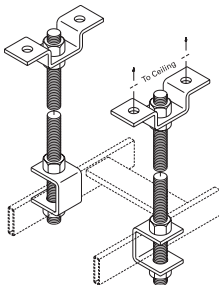

Drawing shows 2 kits

*Note: Recommended spacing between ceiling kits is 5' (1.5 m). The ceiling hole diameter for P/N 11310 is .375" (9.5 mm) for 3/8" or M10 rod; .500" (12.7 mm) for 5/8" or M16 rod.*

## Threaded Ceiling Kit, Cable Runway

Used to suspend Cable Runway from the ceiling. Material is steel, finished with gold over zinc plating.

### Kit consists of:

- (1) ceiling support bracket
- (1) either 3/8-16 x 6", 5/8-11 x 6", M10 x 2M or M16 x 2M threaded rod
- (1) runway support bracket
- (4) either 3/8-16, 5/8-11, M10 or M16 hex nuts

Part Number	Description	Shipping Weight lb (kg)
11310-001	Threaded Ceiling Kit, 3/8" Rod	3 (1.4)
11310-003	Threaded Ceiling Kit, 5/8" Rod	7 (3.2)
11310-093	Threaded Ceiling Kit, M10 x 2M	7 (3.2)
11310-094	Threaded Ceiling Kit, M16 x 2M	7 (3.2)

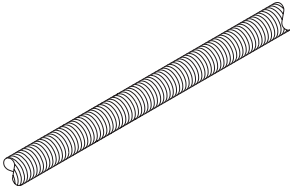

## Threaded Drop Rods

Used to support Cable Runway from ceilings.

- Standard threads, various lengths
- Gold chem film over zinc plate finish

Part Number	Description	Shipping Weight lb (kg)
11440-001	3/8-16 UNC-2A rod, 6'L	2 (0.9)
11440-002	5/8-11 UNC-2A rod, 6'L	5 (2.3)
11440-003	3/8-16 UNC-2A rod, 12'L	5 (2.3)
11440-004	5/8-11 UNC-2A rod, 12'L	10 (4.5)
11440-005	5/8-11 UNC-2A rod, 8'L	7 (3.2)
11440-006	5/8-11 UNC-2A rod, 4'L	4 (1.8)
11440-007	5/8-11 UNC-2A rod, 6"L	1 (0.5)
11440-008	5/8-11 UNC-2A rod, 8"L	1 (0.5)
11440-009	5/8-11 UNC-2A rod, 5.5"L	1 (0.5)
11440-012	5/8-11 UNC-2A rod, 1'L	1 (0.5)
11440-024	5/8-11 UNC-2A rod, 2'L	2 (0.9)
11440-036	5/8-11 UNC-2A rod, 3'L	3 (1.4)

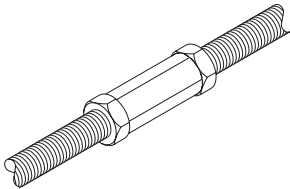

## Threaded Rod Coupling Kit

Used to splice two threaded rods end to end.

Part Number	Description	Shipping Weight lb (kg)
10697-001	For 3/8" Rod	3 (1.4)
10697-002	For 5/8" Rod	3 (1.4)

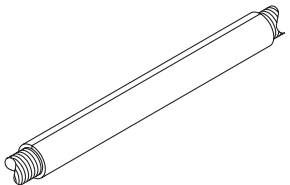

## Threaded Rod Cover

Protects cable from damage during installation.

- Made of plastic PVC tubing. Gray I.D. = 0.630" (16 mm)

Part Number	Description	Shipping Weight lb (kg)
11085-001	Threaded Rod Cover, 10 (3)	5 (2.3)

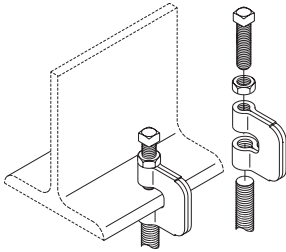

## Threaded Rod I-Beam Clamps, Cable Runway

Fastens a 3/8" or 5/8" threaded rod to an I-beam.

- Material is cold-rolled steel
- Finish is gold over zinc plating

Part Number	Description	Shipping Weight lb (kg)
10557-001	For 3/8"-16 Threaded Rod	3 (1.4)
10557-003	For 5/8"-11 Threaded Rod	3 (1.4)

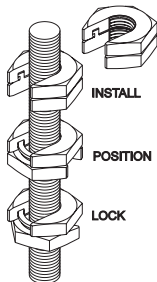

## Slip-On® Lock Nut

Used to add a nut to threaded rod without having to thread from the end. Zinc plated. Slip-On® is a registered trademark of Slip-On Lock Nut Co.

Part Number	Description	Shipping Weight lb (kg)
03003-001	3/8"-16 Slip-On Lock Nut	1 (0.5)
03003-002	5/8"-11 Slip-On Lock Nut	1 (0.5)

Size in (mm)	Recommended Load - lb (kg)	Recommended Torque
3/8 (10)	2,000 (907.2)	19-25 ft/lb (26 Nm-34 Nm)
5/8 (16)	5,000 (2268.0)	100-120 ft/lb (135.6 Nm-162.7 Nm)

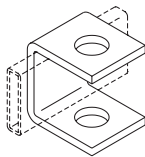

## Runway Support Brackets

Secures threaded rod to Cable Runway. Mounting hardware not included.

Part Number	Description	Shipping Weight lb (kg)
11408-001	For 3/8" (10 mm) or M10 Rod and 1-1/2 (38) Stringers	1 (0.5)
11408-003	For 5/8" (16 mm) or M16 Rod and 1-1/2 (38) Stringers	1 (0.5)

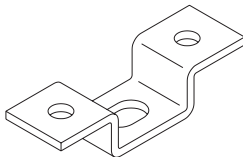

## Ceiling Support Bracket

Used to attach threaded rod to ceiling. Hardware is not included.

Part Number	Description	Shipping Weight lb (kg)
11406-001	3/8" (10 mm) or M10 Rod	1 (0.5)
11406-002	5/8" (16 mm) or M16 Rod	1 (0.5)

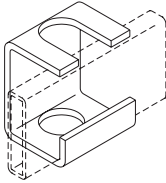

## Slotted Support Bracket

Secures threaded rod to Cable Runway.

**Kit consists of:**

- (1) slotted support bracket
- (2) hex nuts
- (2) split lock washers

Part Number	Description in (mm)	Shipping Weight lb (kg)
10607-002	For 3/8" or M10 Rod and 1-1/2" (38) Stringers	1 (0.5)
10607-001	For 5/8" or M16 Rod and 1-1/2" (38) Stringers	1 (0.5)

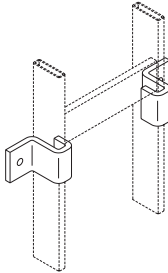

## Vertical Wall Brackets

Used to secure Cable Runway with 1-1/2" x 3/8" (38 mm x 9.53 mm) stringers to a wall. Sold in pairs.

- Material is 1/4" x 1-1/2" (6.4 mm x 33 mm) steel
- Gold color over zinc plating or painted
- Wall mounting hardware not included

Part Number	Description in (mm)	Shipping Weight lb (kg)
10608-X01	Runway Wall Brackets (Pair), Gold	1 (0.5)

*X=*color: 0=Gold, 1=Gray, 2=Computer Beige, 7=Black, E=Glacier White.

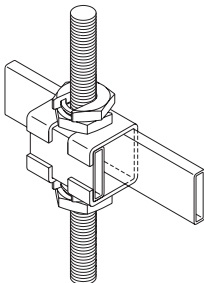

## Slip-On® Support Bracket, Cable Runway

Provides easy additions of Cable Runway layers to existing cable racks by allowing support brackets and nuts to slip over drop rod.

- For use with 5/8" (16 mm) threaded rod only
- Finish is gold over zinc plating

**Kit consists of:**

- (2) patented Slip-On nut
- (1) slotted bracket
- (1) retainer piece

Part Number	Description	Shipping Weight lb (kg)
10873-001	Slip-on Support Bracket	1 (0.5)

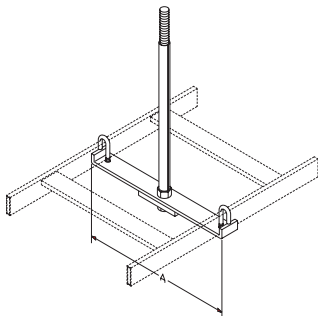

The Cable Runway Center Support Kit is available in sizes to support 6" to 24"W (150 mm to 610 mm) cable runway. Not included: Threaded Rod (P/N 11440-00X) and Ceiling Support Bracket (P/N 11406-002).

## Cable Runway Center Support Kit

This kit has been designed to make installation of cable runway in the ceiling even easier by using just a single point of attachment. The center attachment design not only makes installation easy, but also provides quick and simple cable routing with no need to thread the cable between the runway supports. The support kit securely attaches to the cable runway stringer, eliminating possible dislocations.

- Made of steel
- Provides an "open" support system with quick and simple cable routing
- Threaded rod cover protects cable insulation from damage

### Kit consists of:

- (1) support bracket
- (1) reinforcement bar
- (2) 5/8-11 hex nuts
- (1) 5/8 split lock washers
- (1) 12"L (300 mm) threaded rod cover
- (1) J-bolt kit (2 J-bolts; 2 nuts; 2 washers)

Part Number	Description Width - in (mm)	Dim. A in (mm)	Shipping Weight lb (kg)
12362-X06	6 (150)	6.56 (166.6)	2 (0.9)
12362-X12	12 (300)	12.56 (319.0)	2 (0.9)
12362-X15	15 (380)	16.20 (411.5)	3 (1.4)
12362-X18	18 (460)	19.20 (487.7)	4 (1.8)
12362-X24	24 (610)	25.20 (640.1)	5 (2.3)

X=color: 1=Gray, 2=Computer Beige, 7=Black, E=Glacier White. Gold and Glacier White kits have gold colored hardware. Gray and Black kits have black colored hardware.

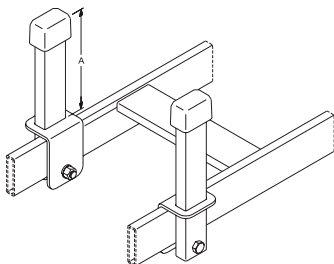

Post and bracket are gold over zinc plating or painted Gray, Black or White. White kits include gold colored hardware. Gray and Black kits include black colored hardware. End cap is black.

## Cable Retaining Post

Provides extra cable depth to existing 1-1/2" (38 mm) cable runway installation. Mounts onto Cable Runway side stringers.

- Post is 1/2" x 1" x .065" (12.7 mm x 25.4 mm x 1.7 mm) wall rectangular steel tubing; bracket is 1046 steel

### Kit consists of:

- (1) Post, bracket and end cap
- (1) 1/4-20 x 1-1/4" hex cap screw, split lock washer and hex nut

Part Number	Height "A" in (mm)	Shipping Weight lb (kg)
10596-X06	6 (150)	1 (0.5)
10596-X08	8 (200)	1 (0.5)
10596-X10	10 (250)	1 (0.5)
10596-X56	6 (150), Pack of 50	29 (13.2)
10596-X58	8 (200), Pack of 50	33 (15.0)
10596-X50	10 (250), Pack of 50	38 (17.2)

X=color: 1=Gray, 2=Computer Beige, 7=Black, E=Glacier White. Gold and Glacier White kits have gold colored hardware. Gray and Black kits have black colored hardware. End caps are black.



## Cable Runway Insulator Bar Kit

Electrically isolates Cable Runway sections, isolating grounded sections of runway or where strong EMI/RFI fields could generate eddy-currents, which could disturb down-line equipment. Made of durable, non-conductive Delrin®.

**Kit consists of:**

- (2) insulator bars, 1.5" H x 3/8" W x 5.5" L (38 mm x 9.53 mm x 140 mm)
- (2) butt-splice kits (P/N/ 11301-001)

Part Number	Description	Shipping Weight lb (kg)
10842-001	Insulator Bar Kit, 1 Kit	2 (0.9)
10842-010	Insulator Bar Kit, 10 Kits	24 (10.9)

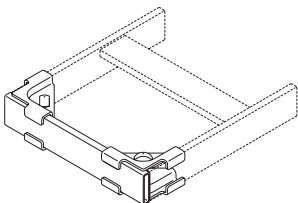

Gold, Computer Beige and Glacier White kits include gold colored hardware. Gray and Black kits include black colored hardware.

## End Closing Kit, Cable Runway

Used to close an unspliced end of Cable Runway. Made of 3/8" x 1-1/2" x .065" (9.53 mm x 38 mm x 1.65 mm) thick rectangular steel tubing.

**Kit consists of:**

- (1) end closing bar
- (4) corner clamp plates
- (2) 3/8-16 x 1 3/8" trimmed round head square neck bolts
- (2) 3/8-16 hex nuts

Part Number	Description	Shipping Weight lb (kg)
11700-X04	End Closing Kit, Cable Runway	4 (100)
11700-X05	End Closing Kit, Cable Runway	5 (130)
11700-X06	End Closing Kit, Cable Runway	6 (150)
11700-X09	End Closing Kit, Cable Runway	9 (230)
11700-X12	End Closing Kit, Cable Runway	12 (300)
11700-X15	End Closing Kit, Cable Runway	15 (380)
11700-X18	End Closing Kit, Cable Runway	18 (460)
11700-X20	End Closing Kit, Cable Runway	20 (510)
11700-X24	End Closing Kit, Cable Runway	24 (610)

X=color: 0=Gold, 1=Gray, 2=Computer Beige, 7=Black, E=Glacier White. Gold, Computer Beige and Glacier White kits have gold colored hardware. Gray and Black kits have black colored hardware.



Tray rests on cross members between stringers.

## Cable Runway Tray

For use with Universal (10250) Cable Runway. Material is .032" (.81 mm) thick sheet aluminum. Length is 9' 11-1/2"/119.5" (3035 mm).

Part Number	Width in (mm)	Shipping Weight lb (kg)
10606-X06	6 (150)	2 (0.9)
10606-X09	9 (230)	3 (1.4)
10606-X12	12 (300)	4 (1.8)
10606-X15	15 (380)	5 (2.3)
10606-X18	18 (460)	6 (2.7)
10606-X24	24 (610)	9 (4.1)

X=color: 1=Gray, 2=Computer Beige, 7=Black, E=Glacier White.



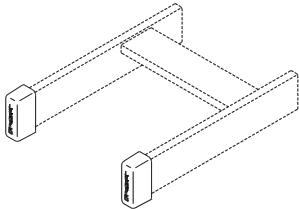

## Protective End Caps For Runway

Covers and protects exposed ends of cable runway and auxiliary framing bar and channel. Reduces chances of personal injury and equipment damage.

- Made of fire-retardant flat black colored rubberized material
- Sold in pairs

Part Number	Description in (mm)	Shipping Weight lb (kg)
10642-001	For 1-1/2 x 3/8 (38 x 9.53) Stringer	1 (0.5)
10757-001	For 2 x 3/8 (50 x 9.53) Auxiliary Bar	1 (0.5)

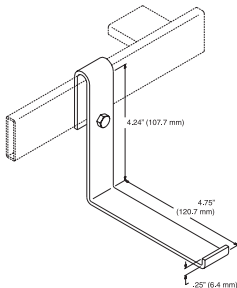

## "L" Bracket, Cable Runway

Bracket provides a separate facility for running power conductors or other cables that should be physically separated from main cables.

- Made of 1/8" x 1" (3.18 mm x 30 mm) steel; gold finish/color over zinc plating

### Kit consists of (1):

- Bracket for 1-1/2" stringer
- 1/4-20 x 3/4" hex bolt

Part Number	Description	Shipping Weight lb (kg)
11268-001	"L" Bracket	1 (0.5)



12 oz (340 g)  
pressurized can

## Touch-Up Paint In Spray Can

Air dry lacquer for touching up finish. Matches color and gloss of CPI's textured paint; air dries to hard finish in minutes.

Part Number	Description oz (g)	Shipping Weight lb (kg)
25400-X00	12 (340) Spray Can	2 (0.9)

X=color: 1=Gray, 2=Computer Beige, 7=Black, E=Glacier White.



1 oz (30 g) bottle  
with applicator

## Touch-Up Paint In Bottle

Air dry waterborne paint for touching up finish. Matches color and gloss of CPI's textured paint.

Part Number	Description oz (g)	Shipping Weight lb (kg)
25401-X00	1 (30) Bottle	2 (0.9)

X=color: 1=Gray, 2=Computer Beige, 7=Black, E=Glacier White.

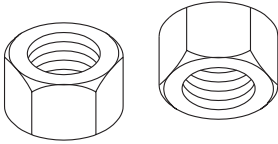

## Hex Nuts

- Zinc plate or gold chem (yellow zinc pate) finish
- Sold individually (each) or in packs of 100

Part Number		Nominal Size	Finish	Shipping Weight lb (kg)
Each	Pack of 100			
20142-071	20142-171	1/4-20	Gold	1 (0.5)
20017-071	20017-171	1/4-20	Zinc Plated	1 (0.5)
20142-081	20142-181	5/16-18	Gold	1 (0.5)
20017-081	20017-181	5/16-18	Zinc Plated	1 (0.5)
20142-091	20142-191	3/8-16	Gold	2 (0.9)
20017-091	20017-191	3/8-16	Zinc Plated	2 (0.9)
03001-001	03001-101	1/2-13	Gold	4 (1.7)
20142-111	20142-121	5/8-11	Gold	7 (3.3)

Note: Shipping weights are for Pack of 100.

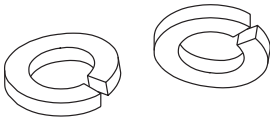

## Split Lock Washers

- Zinc plate or gold chem (yellow zinc pate) finish
- Sold individually (each) or in packs of 100

Part Number		Nominal Size	Finish	Shipping Weight lb (kg)
Each	Pack of 100			
04003-002	04003-102	1/4"	Gold	1 (0.5)
20015-070	20015-170	1/4"	Zinc Plated	1 (0.5)
20141-080	20141-180	5/16"	Gold	1 (0.5)
20015-080	20015-180	5/16"	Zinc Plated	1 (0.5)
20141-090	20141-190	3/8"	Gold	1 (0.5)
20015-090	20015-190	3/8"	Zinc Plated	1 (0.5)
20141-100	20141-110	1/2"	Gold	1 (0.5)
04003-001	04003-101	5/8"	Gold	1 (0.5)

Note: Shipping weights are for Pack of 100.

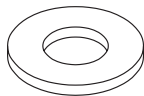

## Washers: Type A Plain

- Zinc plate or gold chem (yellow zinc pate) finish
- Sold individually (each) or in packs of 100

Part Number		Nominal Size	Finish	Shipping Weight lb (kg)
Each	Pack of 100			
20283-012	20283-112	5/16" Wide	Zinc Plated	1 (0.5)
04002-002	04002-102	3/8" Wide	Gold	1 (0.5)
20283-013	20283-113	3/8" Narrow	Zinc Plated	1 (0.5)
04002-001	04002-101	5/8" Wide	Gold	1 (0.5)
20283-022	20283-122	5/8" Wide	Zinc Plated	1 (0.5)

Note: Shipping weights are for Pack of 100.

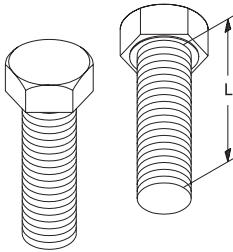

## Hex Cap Bolts

Also called Washer Faced Hex Cap Screws.

- Commercial grade
- Zinc plate or gold chem (yellow zinc plate) finish
- Sold individually (each) or in packs (quantities vary)

Part Number		Nominal Size	Length	Finish	Pack Qty	Shipping Weight lb (kg)
Each	Pack					
20290-106	20290-116	1/4-20	3/4"	Zinc Plated	100	2 (0.8)
20290-118	20290-128	1/4-20	2-1/4"	Zinc Plated	100	4 (1.8)
20290-216	20290-226	5/16-18	2"	Zinc Plated	100	6 (2.5)
20290-307	20290-317	3/8-16	7/8"	Zinc Plated	100	5 (2.1)
02004-001	02004-101	3/8-16	1-1/4"	Gold	100	6 (2.5)
02004-002	02004-102	1/4-20	1-1/4"	Gold	100	3 (1.1)
02004-003	02004-103	1/2-13	1-1/2"	Gold	100	12 (5.3)
02004-004	02004-104	3/8-16	1-1/2"	Gold	100	6 (2.5)
02004-005	02004-105	1/2-13	1-3/4"	Gold	100	13 (5.9)
02004-006	02004-056	5/8-11	1-1/4"	Gold	50	9 (3.9)
02004-007	02004-057	5/8-11	3-1/4"	Gold	25	8 (3.8)

*Note: Shipping weights are for Pack Quantity. Please note pack quantity column.*

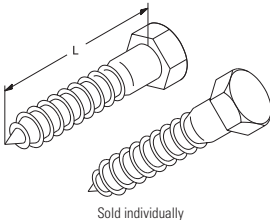

## Hex Lag Screw

Used to install racks onto wood or other soft surfaces.

- Gold chem (yellow zinc plate) over zinc plate finish
- Sold individually (each) or in packs (quantities vary)

Part Number		Nominal Size	Length	Pack Qty	Shipping Weight lb (kg)
Each	Pack				
02006-001	02006-051	1/2-6	2"	50	6 (2.6)
02006-002	02006-052	5/8-5	2"	50	11 (4.8)
02007-004	02007-104	1/4-10	2"	100	3 (1.4)
20098-832	20098-132	3/8-7	2"	100	7 (3.0)

*Note: Shipping weights are for Pack Quantity. Please note pack quantity column.*

## ENVIRONMENTAL MONITORING & SECURITY SYSTEMS



Remote Infrastructure Management (RIM-750)

Page 4-3

Remote Infrastructure Management (RIM-1000)

Page 4-6

Remote Infrastructure Management (RIM) Protocol Converter

Page 4-10

Electronic Lock Kits

Page 4-11

# ENVIRONMENTAL MONITORING & SECURITY SYSTEMS

With all the attention given to virtual security threats, like hacking and viruses, you do not want to be concerned about a security breach at the cabinet level as well. CPI's Environmental Monitoring and Security Systems offer an array of products that keep an eye on everything from temperature and moisture, to physical movement in the equipment room and unauthorized access to the cabinet door. Many of these products can also be directed into CPI's Remote Infrastructure Management System, allowing much of your data center's security, safety and functionality to be monitored remotely at any time of day.

## **Remote Infrastructure Management**

CPI's Remote Infrastructure Management (RIM) System consists of a full line of appliances and sensors that provide continuous environmental, power and security monitoring in your data centers and equipment rooms. The RIM System allows for interconnectivity with building management systems and provides an integrated view of all facility equipment using a simple web interface.

The RIM-750 is perfect for monitoring a single cabinet or small equipment room, while the RIM-1000 is a scalable solution that allows you to monitor a row of high-density cabinets or small computer room in addition to displaying information from other RIM-750's or RIM-1000's for a single, web-based, comprehensive view of multiple locations. The RIM Protocol Converter converts sensor output from facilities equipment between SNMP, BACnet and Modbus protocols for integration into a building management system or a network management systems.

- The RIM-750 System provides remote monitoring of environmental sensors for a single server cabinet or a small computer or telecommunications equipment room. Select from a full line of sensors for continuous environmental, power and security monitoring.
- The RIM-1000 System provides remote monitoring of sensors and devices in your data centers and equipment rooms. Select from a full line of sensors for continuous environmental, power and security monitoring.
- The RIM System Protocol Converter provides protocol translation to simplify equipment integration into facility monitoring and management systems. It is ideal for situations where data from monitored equipment is incompatible with the protocols used by the BMS or NMS, such as is typically the case with legacy equipment or monitoring systems.

## **Electronic Lock Kits for Cabinets**

Electronic Lock Kit is a retrofit kit for the cabinet door that enhances security by eliminating the need for keys and allowing quick lock reprogramming if there is a security concern.



RIM-750



RIM-750  
Rear View

## Certifications:

- CE
- ETL listed: conforms to UL 61010-1, EN 61010-1
- Certified to CSA C22.2 NO. 61010-1
- RoHS compliant

## Remote Infrastructure Management (RIM-750)

The RIM-750 is a compact appliance that has multiple inputs for monitoring a wide range of conditions. There are four inputs for temperature and temperature/humidity sensors, eight digital inputs for dry contact sensors, and a single input for leak detection. Use the digital inputs to monitor magnetic door sensors, motion sensors, a smoke detector, or summary alarms from other equipment. The leak detection connection supports a single zone with up to 200 feet (60 meters) of Sensor Rope. There is also a single relay output (NO/NC) that can be triggered manually or by the condition/status of an input.

RIM-750 has a simple, intuitive web based interface for easy setup and monitoring. The main dashboard displays all sensor conditions in a single view. RIM-750 also summarizes events and logs and displays temperature and humidity sensor data in a line graph on the main page, so you can see trends. For sensors and inputs, you select the alarm condition and how to respond to an alarm with a sound, light, email and/or by enabling the relay. For leak detection, you can also set sensitivity and monitor for both leak and cable break.

## Features:

- Remote monitoring of sensors in computer and network equipment rooms
- Simple installation and setup
- Web-accessible with a clean, easy-to-use, mobile-friendly web interface that displays sensor readings and trends
- Monitors eight digital inputs and four temperature or temperature/humidity sensors, plus one zone of leak detection with up to 200 feet (60 meters) of Sensor Rope
- USB power inlet allows you to power RIM-750 with the included wall adapter or a USB port on a server or other device, such as the eConnect® PDU
- Multiple alarm notification configurations, including audible and visible indicators, email messaging and/or relay activation
- Relay output allows for simple control of an external device upon alarm condition
- Modbus or SNMP output enables simple integration with other facility management systems (BMS)
- Integrated logging and trending, including CSV downloadable trending data

Part Number	Description	Shipping Weight lb (kg)
60100-001	RIM-750, with 4 Temperature/Humidity inputs, 8 digital inputs, 1 leak detection input, 1 relay output, black	2 (0.9)
60100-002	RIM-750 and Leak Detection Kit Bundle, includes 1 RIM-750 with a Leak Detection Lead Cable and 200' (60 m) of Leak Detection Sensor Rope	9 (4.1)

*Note: Leak Detection Lead Cable and Leak Detection Sensor Ropes can also be ordered separately.*

# REMOTE INFRASTRUCTURE MANAGEMENT (RIM-750)

## Specifications:

- Includes:
  - (1) RIM-750, (1) network cable, 3.3 ft (1m) long, (1) USB power adapter with USB mini B to USB A cable
- Power:
  - Power with included wall adapter or from USB port with 5VDC @ 500mA max. output
  - USB mini-B power inlet, (US) 5VDC @ 500mA max.
  - Includes a 110/240VAC 50/60Hz wall adapter with US (type "A") outlet blade and type "C", "G" & "I" adapter blades
- Wired Inputs:
  - Temperature/Humidity: 4 each, 1-wire digital temperature or 1-wire digital temperature/humidity sensor inputs; plug-and-play; configurable alarm points
  - Digital: 8 each, digital alarm points; configurable
  - Leak Detection: 1 each, zone leak detection, supports 200 ft (60 m) of conductive fluid Sensor Rope; Leak Detection Lead Cable and Sensor Rope(s) must be ordered separately
- Relay Output:
  - 1 each, Form C summary relay; 2A @ 30VDC, 0.5A @125VAC; configurable as summary alarm output or manual operation
- Alarm Notification:
  - Panel: Audible alarm, visible LED
  - Integrated Web Interface: Dashboard overview with alarm indicators
  - Email: up to 8 email recipients; email sent on alarm to all recipients, distribution list, or email-to-SMS
  - SNMP Traps: Multiple community strings
  - Relay: 1 Form C summary relay output
- Web Interface Login Security:
  - 8 password read only, 8 password read/write
- Communication Port:
  - Ethernet: 10/100 BaseT, RJ45 connector; 500VAC RMS isolation; DHCP enabled; Static IP-addressable
- Protocols:
  - TCP/IP: ARP; DNS; UDP; DHCP; ICMP
  - HTML: Supports multiple simultaneous connections
  - SMTP (email): SMTP authentication; SMTP relay; supports SSL; up to 8 recipients
  - Modbus TCP/IP: Modbus slave; TCP/IP transmission protocol
  - SNMP: V1; V2C MIB-2 compliant; NMS manageable with Get and Traps; V2C Get, V2C and V1 Traps
  - NTP: Custom server settings
- Logging: Logs 50 most recent alarm and return to normal events with date/time stamp.
- Trending: Records up to 86,400 points of sensor data. Sample interval set from 1 second to 1 day. CSV downloadable.
- Operating Environment
  - Temperature: -40°F to 185°F (-40°C to 85°C)
  - Humidity: 0% to 100% RH, non-condensing
  - Altitude: 15,000ft (4,572m) max.
  - Storage Environment: -40°F to 185°F (-40°C to 85°C)
- Dimensions: 1.00"H x 5.63"W x 2.63"D (25mm x 143mmW x 67mmD)
- Weight: 10.1 oz. (287g)
- Mounting: Stand alone; keyholes included for wall mount; rack-mount bracket available



## Rack Mount Bracket

- Holds two RIM-750 units
- 1U x 19" EIA x 3"D (76 mm)
- Black Finish

Part Number	Description	Shipping Weight lb (kg)
60107-001	Rack-Mount Bracket, 1U x 19" EIA x 3"D (76 mm)	1 (0.5)

# REMOTE INFRASTRUCTURE MANAGEMENT (RIM-750)

Part Number	Sensors for RIM-750	Shipping Weight lb (kg)
<b>Temperature and Humidity Sensors</b>		
60108-001	Temperature Sensor, RJ11, 25'L (7.6 m) cord	1 (0.5)
60108-002	Temperature and Humidity Sensor, RJ11, 25'L (7.6 m) cord	1 (0.5)
<b>Digital Input, Sensors *</b>		
60109-001	Leak Spot Detector, with 14'L (4.2 m) cable*	1 (0.5)
60110-001	Power Fail Monitor, with 120 VAC, 15A connection	1 (0.5)
60113-002	Smoke Detector, Power Supply included	2 (0.9)
60114-002	Motion Detector, Power Supply included	2 (0.9)
60115-001	Magnetic Door Sensor	1 (0.5)
<b>Leak Detection, Sensors</b>		
60116-001	Leak Detection Lead Cable, 15'L (4.57 m) and End of Line Terminator*	1 (0.5)
60109-003	Leak Detection Sensor Rope, 10 ft L (3.0 m)	1 (0.5)
60109-004	Leak Detection Sensor Rope, 25 ft L (7.6 m)	1 (0.5)
60109-005	Leak Detection Sensor Rope, 50 ft L (15.2 m)	3 (1.4)
60109-006	J-Clips, adhesive backing, to install Sensor Rope, Pack of 10	1 (0.5)
60109-007	J-Clips, adhesive backing, to install Sensor Rope, Pack of 50	1 (0.5)

*Note: The RIM-750 has four connections for temperature and humidity sensors, eight connections for digital input sensor, and one built-in single-zone leak detection controller that supports up to 200 feet (60 m) of Sensor Rope, one Leak Detection Lead Cable is required to attach Sensor Rope(s) to the RIM-750. Connect Sensor Ropes end-to-end to extend length, as required. Do not exceed 200 feet (60 m).*

*Alternately, you can use up to four Leak Spot Detectors, which attach to one of the eight digital inputs on the RIM-750. When using a mix of Sensor Rope and Leak Spot Detectors, each Leak Spot Detector reduces the total footage of Sensor Rope supported by the built-in single-zone controller by 50 feet (15.2 m). For example, if you use two leak Spot Detectors, the RIM-750 will only support up to 100 feet (30 m) of Sensor Rope. Smoke Detector and Motion Sensor require an external power source (a VAC power supply is included).*

Additional sensors available. Visit [www.chatsworth.com](http://www.chatsworth.com)





RIM-1000



RIM-1000  
Rear View

## Certifications:

- CE
- ETL listed: conforms to UL 61010A-1, EN 61010  
Certified to CAN/CSA C22.2 NO. 1010.1
- RoHS compliant

## Remote Infrastructure Management (RIM-1000)

The (RIM-1000) System from Chatsworth Products (CPI) provides remote monitoring of sensors and devices in your data centers and equipment rooms. RIM-1000 creates a critical early warning system that monitors conditions in your facility and notifies you when conditions change, so you can take immediate action. It also collects and stores sensor data for analysis to help you troubleshoot issues and optimize site conditions.

RIM-1000 supports analog sensor, digital sensor, Modbus, SNMP and BACnet/IP inputs for monitoring a wide range of site equipment and conditions. The basic model includes eight configurable inputs and two relay (NO/NC) outputs. The configurable inputs can be used to attach and monitor external analog (4-20mA) or digital (dry contact NO/NC) sensors. The basic model is expandable with your choice of additional input/output or input-only expansion cards. The 1U model supports one expansion card. The 2U model supports four expansion cards. A fully expanded 2U model supports up to 96 additional inputs or a mix of up to 48 additional inputs and 32 additional outputs. Additionally, the RIM-1000 can monitor up to 32 devices integrated through Modbus, SNMP or BACnet/IP (up to 1000 registers / OIDs / Instances) collected from facilities equipment through the network or EIA-485 ports. For example with the RIM-1000 you can configure direct branch circuit monitoring (BCM) for current monitoring at the electrical panel board.

The web interface summarizes device and sensor input conditions with color-coding and displays the physical location of devices and sensors on a floor plan or map. Alarms and Event History are also summarized on separate tabs for easy review and acknowledgement. Logs can be manually downloaded for detailed review or archiving. In addition to monitoring sensors and devices, the webpage also provides links for up to 32 other slave devices including equipment or other RIM products and links for 10 additional IP addresses that can be used for viewing web cams or websites, so you can view all systems from a single RIM-1000 webpage. Alternately, RIM-1000 can provide Modbus, BACnet or SNMP output for integration with other facility management systems.

Select from several pre-configured models or add expansion cards as required to meet your specific requirements.

## Features:

- Remote monitoring of sensors and devices in your data centers and equipment rooms
- Configurable with expansion cards for a large number of sensor inputs
- Provides one integrated view of all facility equipment
- Accepts inputs from a wide range of environmental sensors and facility equipment
- Stores data internally, so there is no need for additional equipment or software to store or access data
- Provides a single web-based interface for accessing and reviewing all data
- Monitors user-set thresholds and sends SNMP traps, email or SMS alarm notifications for events
- Provides Modbus, BACnet and SNMP output for integration with other facility management systems

## Specifications:

- Includes:
  - (1) RIM-1000; (1) Power Supply with 24VDC models only and (1) Rack-mount brackets
- Power:
  - 1U, 24VDC Model: 24VDC ( $\pm 10\%$ ), 1A max., external power supply included
  - 1U, 48VDC Model: 36-72VDC, 0.5A max., power input terminal block
  - 2U, 24VDC Model: 24VDC ( $\pm 10\%$ ), 2.5A max., external power supply included
  - 2U, 48VDC Model: 36-72VDC, 1.25A max., power input terminal block
- Grounding: External ground point for chassis and EIA-485
- Inputs:
  - Analog/Digital: 8 Configurable as 4-20mA (12-bit A/D conversion) or Dry Contact NO/NC (<25mA)
  - Keypad: Standard 3x4; 3000VAC RMS optically isolated; 20 User Access Codes (accessible via phone/DTMF through modem)
- Outputs:
  - Relay: 2 Dry Contact, Form C, 1A @ 24VDC, 0.5A resistive @ 120VAC (controllable via user programmable logic)
  - Sensor/Accessory Power: 24VDC ( $\pm 10\%$ ) @ 300mA max. (power for external sensors and/or devices)
- Expansion Cards:
  - 1U model accommodates 1 expansion card
  - 2U model accommodates up to 4 expansion cards
  - 24VDC model requires 24VDC expansion cards
  - 48VDC model requires 48VDC expansion cards
  - Expansion Card A: 12 analog (jumper selectable for 4-20mA, 0-5VDC or 0-10VDC) or digital normally open (NO) dry contact inputs (non-isolated, individual ground only); and 8 Form C Relay Outputs, 1A @ 24VDC, 0.5A resistive @ 120VAC. 48VDC model accepts only 1 Card A.
  - Expansion Card C: 24 digital normally open or normally closed dry contact inputs, 3000VAC RMS optically isolated (common or individual ground)
- Communication Ports:
  - Ethernet: 10/100BaseT, RJ45 connector; 500VAC RMS isolation
  - RS-232: DB9 female connector; 9600 baud; 3000VAC RMS optically isolated; 15kV ESD protection
  - EIA-485 (selectable as RS-232): Two-wire half duplex; terminal block (selecting RS-232 switches to DB9 male connector); 1200, 2400, or 9600 baud configurable; 3000VAC RMS optically isolated 3000VAC RMS optically isolated
  - Modem (RJ11 Telco; ordered separately): V.34bis/33.6 kbps; DTMF capable; PPP-enabled; FCC Part 68 approved; 1500VAC RMS isolation barrier; 2100V peak surge protection
- Protocols:
  - TCP/IP; UDP/IP; ICMP/IP; FTP; NTP; IPv4
  - HTTP/HTML; SNMP; Telnet: 1.1/4.0; up to 10 URL links to other IP addressable cameras/devices; Webpages comply with Rehabilitation Act of 1973, sections 504 and 508, US Dept. of Education
  - SNMP: V1: MIB-2 compliant; NMS Manageable with Get, Set, and Traps; V2c: Traps or Informs
  - SMTP (email): Supports Client Authentication (plain and login); compatible with ESMTTP Servers
  - Modbus: RTU transmission protocol; function codes: Slave - 03; Master - 01, 02, 03, 04
- Protocols:
  - Modbus/IP: Modbus Slave; TCP/IP transmission protocol; Reads up to 628 registers and converts to SNMP and BACnet
  - BACnet/IP: Reads up to 106 instances and converts to SNMP and Modbus
  - Terminal Emulation: VT100 compatible
  - TAP (Pager): Telocator Alphanumeric Protocol v1.8
- Alarm Notification
  - Pager (With Optional Modem) – Optional: 15 text, numeric, or alphanumeric pager numbers
  - Email (Ethernet, With Optional Modem through PPP): 8 email recipients; email sent on Alarm and Return To Normal
  - SNMP Traps (Ethernet): V1 and V2c: 4 Trap IPs/Community Strings
  - Escalation (with Optional Modem): Additional notification to 1 of the 15 pager numbers when the initial page results in a Failure To Acknowledge status
- Health Check/Self-Monitoring: Self resetting; captured in Log
- Internal Hardware:
  - Real Time Clock: Battery backed;  $\pm 1.53$  min/month accuracy
  - Memory: 16MB RAM; 128K NVRAM; 16MB Flash
- Logging Capabilities:
  - Alarm Log: Last 256 Alarms
  - Event Log: Last 100 Events
  - Web User Access Log: Last 100 HTML Accesses
  - Digital Status Log: Last 100 Digital Status entries
  - Trending of Analog Inputs: 244 entries per time frame, per channel. High, low, and average values logged
  - Extended Trending (Analog Inputs): 3,840 entries over 32 inputs, physical or over Modbus. Logging at defined, user-selectable intervals.
- Login Security:
  - Web Browser Access (Ethernet, Modem, PPP): 1 Administrator plus 7 users
  - Terminal Emulation Access (Modem): 1 Administrator
- Front Panel Interface: 1 on/off power switch. Red and green LEDs indicate status, network link, network and modem activity
- Operating/Storage Environment:
  - Operating temperature: 32° to 158°F (0° to 70°C).
  - Humidity: 5% to 95% RH, non-condensing.
  - Altitude: 15,000ft (4,572m) max.
  - Storage temperature: -40° to 185°F (-40°C to 85°C)
- Dimensions and Weight:
  - 1U model: 1.8" H x 16.8" W x 7.9" D (46mm H x 427mm W x 201mm D); 6 lb (2.72 kg)
  - 2U model: 3.5" H x 16.8" W x 7.9" D (89mm H x 427mm W x 201mm D); 10 lb (4.54 kg)
- Mounting: 19" EIA, rack-mount brackets included; wall mount brackets available (sold separately)

# REMOTE INFRASTRUCTURE MANAGEMENT (RIM-1000)

Part Number	(RIM-1000) System – 24 VDC Models (Rack Space, Input Power, Inputs, Outputs, Expansion Cards)	Shipping Weight lb (kg)
60101-001	1U, 24VDC, 8 configurable analog or digital NO/NC inputs, 2 relay outputs, 1 open expansion card slot, black	11 (5.0)
60101-002	1U, 24VDC, 8 configurable analog or digital NO/NC inputs, 12 configurable analog or digital NO inputs*, 10 relay outputs, no open expansion card slots, black	11 (5.0)
60101-003	1U, 24VDC, 8 configurable analog or digital NO/NC inputs, 24 digital NO/NC input, 2 relay outputs, no open expansion card slots, black	11 (5.0)
60101-004	2U, 24VDC, 8 configurable analog or digital NO/NC inputs, 2 relay outputs, 4 open expansion card slots, black	16 (7.3)
60101-005	2U, 24VDC, 8 configurable analog or digital NO/NC inputs, 12 configurable analog or digital NO inputs*, 10 relay outputs, 3 open expansion card slots, black	16 (7.3)
60101-006	2U, 24VDC, 8 configurable analog or digital NO/NC inputs, 24 digital NO/NC inputs, 2 relay outputs, 3 open expansion card slots, black	16 (7.3)
60101-007	2U, 24VDC, 8 configurable analog or digital NO/NC inputs, 12 configurable analog or digital NO inputs*, 24 digital NO/NC inputs, 10 relay outputs, 2 open expansion card slots, black	16 (7.3)
60101-008	2U, 24VDC, 8 configurable analog or digital NO/NC inputs, 24 configurable analog or digital NO inputs*, 18 relay outputs, 2 open expansion card slots, black	16 (7.3)
60101-009	2U, 24VDC, 8 configurable analog or digital NO/NC inputs, 48 digital NO/NC inputs, 2 relay outputs, 2 open expansion card slots, black	16 (7.3)
60101-010	2U, 24VDC, 8 configurable analog or digital NO/NC inputs, 48 configurable analog or digital NO inputs*, 34 relay outputs, no open expansion card slots, black	16 (7.3)
60101-011	2U, 24VDC, 8 configurable analog or digital NO/NC inputs, 96 digital NO/NC inputs, 2 relay outputs, no open expansion card slots, black	16 (7.3)
60101-012	2U, 24VDC, 8 configurable analog or digital NO/NC inputs, 12 configurable analog or digital NO inputs*, 72 digital NO/NC inputs, 10 relay outputs, no open expansion card slots, black	16 (7.3)

*Note: The 12/24/48 configurable analog or digital NO inputs\* in these models are configured for a 4-20mA input, but can be manually reconfigured to 0-5 VDC or 0-10 VDC inputs by changing jumper settings on the expansion card. 48 VDC Models are also available. Refer to the Technical Data Sheet for detailed specifications.*

You can add expansion cards to the RIM-1000 to provide additional connections for external sensors and additional relay outputs. When selecting an expansion card, check your RIM-1000 to be sure there is an open expansion card slot and be sure to match the input voltage of your RIM-1000 (24 VDC or 48 VDC).

Expansion Cards for RIM-1000 System		
Part Number	Description	Shipping Weight lb (kg)
60103-001	Expansion Card A, for 24 VDC or 48VDC RIM-1000, 12 configurable analog or digital NO inputs*, 8 relay outputs (maximum one can be installed in a 48 VDC RIM-1000)	1 (0.5)
60103-002	Expansion Card C, for 24 VDC RIM-1000, 24 digital NO/NC inputs	1 (0.5)

*Note: 1U units have 1 expansion card slot. 2U units have 4 expansion card slots. An internal modem (for pager and PPP/dialup connections), and wall mount brackets are also available.*

# REMOTE INFRASTRUCTURE MANAGEMENT (RIM-1000)

Part Number	Analog Input, Sensors for RIM-1000	Shipping Weight lb (kg)
60111-001	Temperature Sensor, No Display, 50°F to 95°F (10°C to 35°C)	1 (0.5)
60111-002	Temperature Sensor, With Display, Selectable Range 50°F to 95°F (10°C to 35°C) or 32°F to 122°F (0°C to 50°C)	1 (0.5)
60111-003	Humidity Sensor, No Display, 2% Accuracy RH	1 (0.5)
60111-004	Temperature and Humidity Sensor, No Display, 2% Accuracy RH, Selectable Temperature Range 50°F to 95°F (10°C to 35°C) or 32°F to 122°F (0°C to 50°C)	1 (0.5)
60111-005	Temperature and Humidity Sensor, With Display, 2% Accuracy RH Selectable Temperature Range 50°F to 95°F (10°C to 35°C) or 32°F to 122°F (0°C to 50°C)	1 (0.5)
60111-006	Temperature and Humidity Sensor, No Display, 3% Accuracy RH, Selectable Temperature Range -20°F to 140°F (-28.9°C to 60°C); 0°F to 100°F (-17.8°C to 37.8°C); 40°F to 90°F (4.4°C to 32.3°C); or -4°F to 140°F (-20°C to 60°C),	1 (0.5)
60111-007	Temperature and Humidity Sensor, With Display, 3% Accuracy RH, Selectable Temperature Range -20°F to 140°F (-28.9°C to 60°C); 0°F to 100°F (-17.8°C to 37.8°C); 40°F to 90°F (4.4°C to 32.3°C); or -4°F to 140°F (-20°C to 60°C),	1 (0.5)
60112-001	Temperature Sensor, Miniature, 40°F to 100°F (4°C to 38°C) Range, with 18"L (450 mm) Lead Cable	1 (0.5)
60112-002	Temperature Sensor, Miniature, 40°F to 100°F (4°C to 38°C) Range, with 5'L (1.5 m) Lead Cable	1 (0.5)
60112-003	Temperature Sensor, Miniature, 40°F to 100°F (4°C to 38°C) Range, with 25'L (4.5 m) Lead Cable	1 (0.5)
Digital Input , Sensors for RIM-1000		
60109-001	Leak Spot Detector, with 14'L (4.2 m) cable	1 (0.5)
60109-002	Leak Detection Controller Kit, 10 ft (3 m) Sensor Rope, Power Supply	1 (0.5)
60109-003	Leak Detection Sensor Rope, 10 ft L (3.0 m)	1 (0.5)
60109-004	Leak Detection Sensor Rope, 25 ft L (7.6 m)	1 (0.5)
60109-005	Leak Detection Sensor Rope, 50 ft L (15.2 m)	3 (1.4)
60109-006	J-Clips, adhesive backing, to install Sensor Rope, Pack of 10	1 (0.5)
60109-007	J-Clips, adhesive backing, to install Sensor Rope, Pack of 50	1 (0.5)
60110-001	Power Fail Monitor, with one 120 VAC, 15A (NEMA 5-15P) connection	1 (0.5)
60113-001	Smoke Detector	1 (0.5)
60114-001	Motion Sensor	1 (0.5)
60115-001	Magnetic Door Sensor	1 (0.5)

*Note: Each combination Temperature and Humidity Sensor uses two Analog Inputs on the RIM-1000, one for temperature and one for humidity. Use Leak Spot Detector to monitor a specific spot for liquid. Use Leak Detection Controller Kit and additional Sensor Rope, if needed, to monitor an area. Leak Detection Controller Kit uses two digital inputs on the RIM-1000, one for leak detection and one for cable break. Sensors require power from the RIM-1000 or another power source. Refer to the Data Sheet for sensor specifications.*

Additional sensors available. Visit [www.chatsworth.com](http://www.chatsworth.com)



60106-001  
Single Port



60106-002  
Dual Port

## Remote Infrastructure Management (RIM) Protocol Converter

The Protocol Converter is ideal for environments where data from monitored equipment is incompatible with the protocols used by the BMS or NMS, especially in applications that feature legacy monitoring systems.

Use RIM Protocol Converter to translate sensor output when your equipment uses one protocol and your BMS or NMS uses a different protocol. The RIM Protocol Converter accepts Modbus TCP/IP, Modbus RTU, SNMP integer data and BACnet/IP inputs and converts the input to BACnet/IP, Modbus TCP/IP, Modbus RTU or SNMP output. The Protocol Converter can attach to 32 devices and accepts and converts up to 1,024 inputs; this functionality allows a single Protocol Converter to flexibly integrate with multiple alarm and management systems. A built-in web-based interface allows easy setup and configuration. In addition to protocol conversion, the RIM Protocol Converter supports BACnet Change-Of-Value (COV), basic register write operation and can send email via your SMTP server if a monitored device stops communicating.

The RIM Protocol Converter is available in two models. Both models include a network connection. The single port Protocol Converter has one EIA-485 communications port, and the dual port Protocol Converter has three EIA-485 communications ports for extended polling over multiple trunk lines. The dual port Protocol Converter is an excellent choice when monitoring a large number of physical inputs. Multiple ports will reduce the cycle time when polling equipment.

### Features:

- Multiple input and output protocols allow easy integration with a wide variety of equipment
- Communicates with building management and network management systems
- Web-based interface simplifies setup and configuration
- Connects up to 32 devices (units, modules, or nodes)
- Monitors up to 1,024 Modbus registers, OID, or instances
- Use the dual port Protocol Converter to connect to multiple trunk lines for faster polling with a large number of devices
- Alarm notification through email when a device stops communicating

Part Number	Description	Shipping Weight lb (kg)
60106-001	RIM Protocol Converter, SNMP/Modbus/BACnet, Single Port, black	5 (2.3)
60106-002	RIM Protocol Converter, SNMP/Modbus/BACnet, Dual Port, Black	5 (2.3)

*Note: Includes (1) Protocol Converter, (1) external power supply and (1) network crossover cabler for initial configuration.*



## Electronic Lock Kit

Electronic Lock Kit is a retrofit kit for the cabinet door that enhances security by eliminating the need for keys and allowing quick lock reprogramming if there is a security concern.

- Standalone electronic keypad lock (not networked, no audit trail)
- Two options: System 1000 or System 1500
- Three user levels with programmable access codes:
  - Master code (8-digit) – full administrative rights
  - Sub-Master code (8-digit) – set/delete user code
  - User code (4-digit)
- System 1000 supports 3 access codes (1 master, 1 sub-master, 1 user), approximately 15,000 openings with new 2 x 1.5 VDC AAA batteries, and has a silver-colored handle with black mounting plate
- System 1500 supports 22 access codes (1 master, 1 sub-master, 20 user), approximately 50,000 openings with new 2 x 3 VDC CR2450 coin batteries, has an audible keypad, dual access code mode and black handle and mounting plate



### F-Series TeraFrame Gen 3 Cabinet Lock Kits:

Part Number - By Door Style For Doors with a Single-Point Latch			Description	Shipping Weight lb (kg)
Front Door Single, Perf	Rear Door Single, Solid	Rear Door Double, Perf		
39222-C00	39223-C00	N/A	System 1000	3 (1.4)
39222-C01	39223-C01	N/A	System 1500	3 (1.4)
Part Number - By Door Style For Doors with a Two-Point Latch			Description	Shipping Weight lb (kg)
Front Door Single, Perf	Rear Door Single, Solid	Rear Door Double, Perf		
39226-C99	39227-C99	39225-C99	System 1000	3 (1.4)
39229-C99	39230-C99	39228-C99	System 1500	3 (1.4)

Note: These part numbers are retrofit Electronic Lock Kits that replace the swing handle on the cabinet door of a F-Series TeraFrame Gen 3 Cabinet. To order this lock kit pre-installed on the cabinet door, use the CPI Product Configurator for the F-Series TeraFrame Gen 3 Cabinet on the CPI website.



### GF-Series GlobalFrame Gen 2 Cabinet Lock Kits:

Part Number - By Door Style			Description	Shipping Weight lb (kg)
Front Door Single, Perf	Rear Door Single, Solid	Rear Door Double, Perf		
39224-C00	39223-C00	39225-C99	System 1000	3 (1.4)
39224-C01	39223-C01	39228-C99	System 1500	3 (1.4)

Note: These are retrofit Electronic Lock Kits that replace the swing handle on the cabinet door of a GF-Series GlobalFrame Gen 2 Cabinet.

# GROUNDING & BONDING PRODUCTS

Busbar, Insulation Products, Tools & Accessories



Busbars

Insulators

Grounding Products

Compression Tools, Lugs & Taps

Page 5-3

Page 5-7

Page 5-9

Page 5-14

## GROUNDING & BONDING PRODUCTS

In response to the increase in newer, more sensitive, highly sophisticated electronic equipment, CPI offers a comprehensive line of UL® Listed Grounding and Bonding Products. The electrical protection and grounding of today's high-speed cabling systems is an essential part of a properly installed IT infrastructure, which is why CPI's Grounding and Bonding Products are designed to provide protection and help prevent transient voltages from damaging sensitive electronic equipment.

Stocked with a wide range of products spanning from grounding busbars and pipe clamps, to ground terminal blocks and ground strap kits, CPI is equipped to handle a full list of safety codes and standards.

### **CPI Grounding and Bonding Products feature:**

- Comprehensive line of products that promote electrical safety throughout the network
- A complete bonding solution with grounding busbars, pipe and floor pedestal clamps, insulators, joint compound, Compression tools and lugs/taps, as well as other equipment
- UL Listed and compliant with industry standards



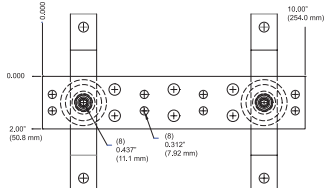

13622-010: (4) Lugs, 5/8" (15.88 mm) hole centers  
(3) Lugs, 1" (25.4 mm) hole centers

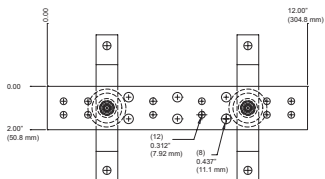

13622-012: (6) Lugs, 5/8" (15.88 mm) hole centers  
(3) Lugs, 1" (25.4 mm) hole centers

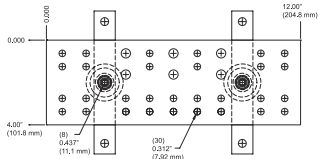

40153-012: (15) Lugs, 5/8" (15.88 mm) hole centers  
(3) Lugs, 1" (25.4 mm) hole centers

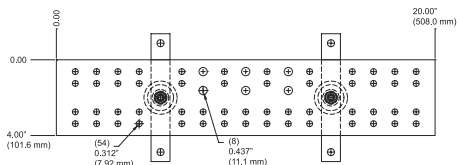

40153-020: (27) Lugs, 5/8" (15.88 mm) hole centers  
(3) Lugs, 1" (25.4 mm) hole centers

## BICSI & ANSI/EIA/TIA Grounding Busbars

The CPI 13622 series Telecommunications Grounding Busbar (TGB) provides a central ground attachment point for telecommunications systems, computers and other equipment located in the data room. The CPI 40153 series Telecommunications Main Grounding Busbar (TMGB) provides a central ground attachment point for telecommunications bonding backbones, equipment and the building's ground electrode system. All CPI Grounding Busbars are UL Listed.

Hole patterns on Busbars accommodate two-hole lugs per the recommendation of BICSI NECA/BICSI 607-2011 and TIA-607-B standards. Insulators electrically isolate Busbars from the wall or other mounting surfaces, thereby controlling the current path.

- Mounting brackets are manufactured from high-quality 300 series stainless steel with 3/8" (9.53 mm) diameter mounting holes spaced 5.75" (146.1 mm) apart
- Busbars mount on the wall, floor or ceiling
- Ships preassembled
- Sold individually
- UL Listed, File E236184, Category KDER (US), KDER7 (Canada)
- Busbar assemblies with lug kits also available
- Other configurations available on request

### Each Busbar consists of:

- (1) Busbar
- (2) insulators
- (2) stand-off brackets
- (4) stainless steel bolts with Torx T-45 head
- Order installation hardware separately

Part Number	Description	Busbar Size H x W x D in (mm)	Shipping Weight lb (kg)
13622-010	10 (250) TGB	2 x 10 x 1/4 (50 x 250 x 6.4)	3 (1.4)
13622-012	12 (300) TGB	2 x 12 x 1/4 (50 x 300 x 6.4)	4 (1.8)
40153-012	12 (300) TMGB	4 x 12 x 1/4 (50 x 100 x 6.4)	7 (3.2)
40153-020	20 (510) TMGB	4 x 20 x 1/4 (50 x 510 x 6.4)	8 (3.6)

*Note: See details at left for lug sizes and quantities. Overall height with stand-off brackets is 6.63" (168 mm); overall depth is 3.13" (80 mm).*

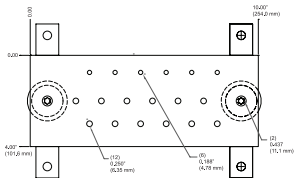

10622-010

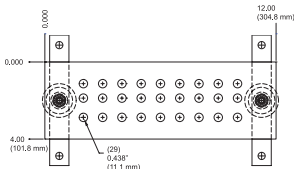

10622-012

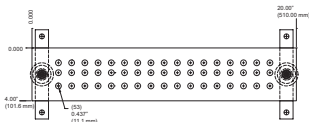

10622-020

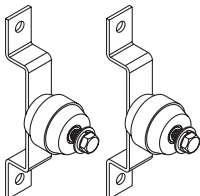

Sold in pairs

## Standard Busbars

CPI Standard Busbars are insulated ground bus mounting plates specifically designed for commercial applications. The hard-drawn electrolytic tough pitch 110 alloy solid copper ground bars are 1/4" (6.4 mm) thick and stand off 2.75" (69.9 mm) from the backboard or wall. The 10" (250 mm) Busbar accepts 1/4" single bolt lugs. The 12" and 20" (300 mm and 510 mm) Busbars provide connection for nine or 17 lugs respectively, accepting lugs with either 3/4", 1" or 1-3/4" (19.1 mm, 25 mm or 44.5 mm) center. Any lug with 3/8" bolts may be used.

- All Busbars ship individually and preassembled
- Other configurations available on request
- UL Listed, File E236184; Category KDER (US), KDER7 (Canada)

### Each Busbar assembly consists of:

- (1) Busbar
- (2) insulators
- (2) stand-off brackets
- (4) stainless steel bolts with Torx T-45 head
- Order installation hardware separately

Part Number	Description	Busbar Size H x W x D in (mm)	Shipping Weight lb (kg)
10622-010	Busbar	4 x 10 x 1/4 (100 x 250 x 6.4)	4 (1.8)
10622-012	Busbar	4 x 12 x 1/4 (100 x 300 x 6.4)	5 (2.3)
10622-020	Busbar	4 x 20 x 1/4 (100 x 510 x 6.4)	8 (3.6)

Overall height with stand-off brackets is 6.63" (168 mm); overall depth is 3.13" (80 mm).

## Busbar Insulator Assemblies

CPI also offers standalone Busbar Insulator Assemblies.

- Ships preassembled
- Replaces CPI P/N 13622-000

### Pair of assemblies consists of:

- (2) stainless steel bolts, 3/8"W x 5/8"L
- (4) lock washers, 3/8"
- (4) flat washers, 3/8"
- (2) stainless steel bolts, 3/8"W x 3/4"L
- (2) insulators, 1-3/4"W x 1-7/8"D, 3/8" threaded insert
- (2) stainless steel wall brackets, 1"W (25 mm), 1" standoff
- Order installation hardware separately

Part Number	Description	Shipping Weight lb (kg)
10622-000	Busbar Insulator Assemblies, 1 Pair	2 (0.9)



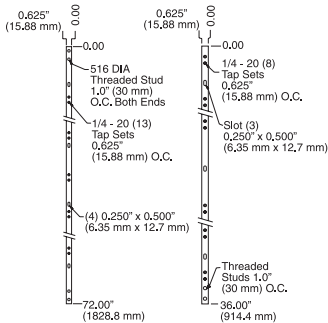

## Vertical Rack Busbar

Vertical Rack Busbar for consolidating equipment grounds. Constructed of 5/8"H x 1/4"W (15.88 mm x 6.4 mm) hard-drawn electrolytic tough pitch 110 alloy copper bar with pairs of #1/4-20 tapped mounting holes on 5/8" (15.88 mm) centers. The 36" (910 mm) bar has one set of #5/16 self-clinching studs on 1" (25.4 mm) centers at one end for attachment of a ground conductor. The 72" (1830 mm) bar has two sets of #5/16 self-clinching studs on 1" (25.4 mm) centers at both ends for attachment of a ground conductor.

- Each package contains one Vertical Rack Busbar
- Vertical Rack Busbars with insulators and lug kits are also available
- Other configurations are available on request
- UL Listed, File E236184, Category KDER (US), KDER7 (Canada) - Grounding and Bonding Equipment

Part Number	Description H x W x D in (mm)	Number of Lugs	Shipping Weight lb (kg)
40160-036	5/8 x 1/4 x 36 (15.88 x 6.4 x 910)	8	4 (1.8)
40160-072	5/8 x 1/4 x 72 (15.88 x 6.4 x 1830)	13	5 (2.3)

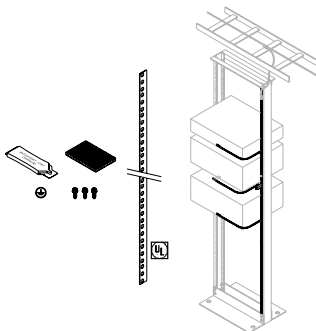

## Vertical Rack Ground Bar Kit

The Rack Ground Bar Kit includes a thin strip of tinned copper that attaches to the rack's equipment mounting rail to provide direct ground contact for rack-mount equipment or a convenient bonding strip. Sized to fit a 7' (2.1 m) high rack with an EIA-310-D Universal hole pattern and 45U, the ground bar is punched with a series of holes that align with each mounting hole on the rack. When equipment is mounted to the rack, the rack-mount brackets touch the ground bar. Alternately, the Equipment Ground Jumper Kit can be used to connect equipment to the grounding bar.

- Each kit includes one ground bar, three #12-24 zinc-plated thread forming hex washer head installation screws, an abrasive pad, joint compound and a ground label
- The ground bar is .05" (1.3 mm) thick tinned copper strip, 78.65"H x .68"W (1997 mm x 17 mm) and is punched with holes that match the EIA-310-D Universal Hole Pattern
- UL Listed Ground Bar, File E236184, Category KDER (US), KDER7 (Canada) - Grounding and Bonding Equipment

Part Number	Description	Shipping Weight lb (kg)
40172-001	Rack Ground Bar Kit	2 (0.9)

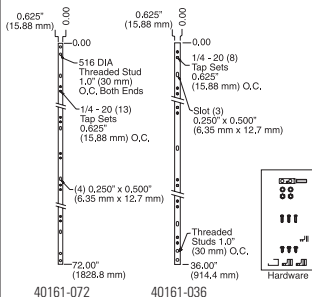

## Vertical Rack Busbar Kits

Vertical Rack Busbar Kits isolate the Busbar from the rack to help control current paths from passing through one piece of equipment to another.

- Other configurations are available on request
- UL Listed, File E236184, Category KDER (US), KDER7 (Canada) - Grounding and Bonding Equipment
- The 36" L (910 mm) bar has one set of #5/16 self-clinching studs on 1" (25.4 mm) centers at one end for attachment of a ground conductor. The 72" L (1830 mm) bar has two sets of #5/16 self-clinching studs on 1" (25.4 mm) centers at both ends for attachment of a ground conductor.

### Kit consists of:

- (1) Vertical Rack Busbar
- (1) #2 AWG two-hole ground compression lug with 3/8" (9.53 mm) holes on 1" (25.4 mm) centers
- (3) white Delrin® insulator blocks
- (3) self-tapping screws
- (3) #12-24 mounting screws
- (2) stainless steel lock washers, 5/16"
- (2) nuts

Part Number	Description H x W x D in (mm)	Shipping Weight lb (kg)
40161-036	5/8 x 1/4 x 36 (15.88 x 6.4 x 910)	6 (2.7)
40161-072	5/8 x 1/4 x 72 (15.88 x 6.4 x 1830)	7 (3.2)

## Rack Ground Jumper Kit

Rack Ground Jumper Kits serve as a rack bonding conductor for CPi's Universal Rack. CPi's Universal Racks include a location for attaching the Rack Ground Jumper Kit inside the rack's vertical equipment mounting channel. Order additional hardware as required to secure the other end of the jumper to the telecommunications equipment bonding conductor or directly to a telecommunications grounding busbar.

### Kit consists of:

- 9' L (2.7 m) #6 AWG stranded copper conductor insulated green with a horizontal yellow stripe attached to a two-hole compression lug with 1/4" (6.35 mm) bolt holes spaced on 5/8" (15.88 mm) centers
- 1/4-20 zinc plated serrated flange hex nuts
- 0.5 oz (14 g) packet of aluminum antioxidant joint compound
- Constructed of UL Listed components, File E236184, Category KDER (US), KDER7 (Canada) - Grounding and Bonding Equipment
- Available individually or in packages of 10



Shown mounted to rack

Part Number	Description H x W x D in (mm)	Shipping Weight lb (kg)
40159-008	Rack Ground Jumper Kit, 1 Each	2 (0.9)
40159-018	Rack Ground Jumper Kit, Pack of 10	12 (5.4)

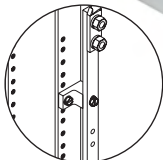

Shown mounted  
between rack and  
Busbar

## Rack Busbar Insulator Block

Rack Busbar Insulator Blocks provide rigid support to physically separate Rack Busbars from all sources of electrical energy. Its offset design securely attaches the Busbar using a #12 self-tapping screw, while allowing unobstructed access to rack-mounted equipment. The Insulator Block has a #12 clearance hole for mounting to the rack.

- Made of durable, nonconductive white Delrin®
- Block measures 3/4" H x 11/16" W x 1-1/4" L (19.1 mm x 17.463 mm x 31.8 mm)

Part Number	Description	Shipping Weight lb (kg)
40157-001	Insulator Block, Each	1 (0.5)
40157-050	Insulator Block, Box of 50	2 (0.9)

## Rack Base Insulator Kit

Rack Base Insulator Kits electrically isolate the racks from the floor for an effective grounding and bonding system. Made of .060" (1.52 mm) thick phenolic insulating material and accepts up to 1/2" diameter screws. Used on concrete floors, not needed for access floor applications.

### Kit consists of:

- (2) isolation plates
- (4) isolation grommets

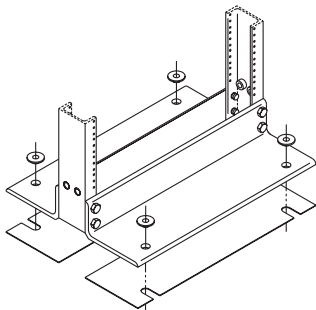

Part Number	Description	Shipping Weight lb (kg)
10605-019	Insulator Kit, 19" Rack	3 (1.4)
10605-023	Insulator Kit, 23" Rack	3 (1.4)



## Cable Runway Insulator Bar Kit

Electrically isolates Cable Runway sections, isolating grounded sections of runway or where strong EM/RFI fields could generate eddy-currents, which could disturb down-line equipment.

- Made of durable, nonconductive white Delrin®
- Available individually or in packages of 10

### Kit consists of:

- (2) insulator bars, 1.5" H x 3/8" W x 5.5" L (38 mm x 9.53 mm x 140 mm)
- (2) butt-splice kits (P/N/ 11301-001)

Part Number	Description	Shipping Weight lb (kg)
10842-001	Insulator Bar Kit, 1 Kit	3 (1.4)
10842-010	Insulator Bar Kit, 10 Kits	25 (11.3)

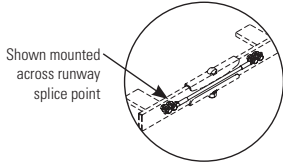
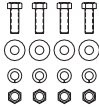
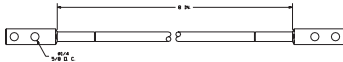

## Cable Runway Ground Strap Kit

Cable Runway Ground Strap Kits provide a ground pathway between cable runway lengths when fastened together across splices. Installation requires drilling 5/16" holes. Ground Straps consist of an 8" L (200 mm) #6 AWG green insulated stranded copper conductor with horizontal yellow stripe attached at both ends to two-hole compression lugs with 1/4" bolt holes spaced on 5/8" (15.88 mm) centers.

- Overall length of 11" (280 mm)
- Available individually or in packages of 25
- Constructed of UL Listed components, File E236184, Category KDER (US), KDER7 (Canada) - Grounding and Bonding Equipment
- Replaces CPI P/N 12061-001
- Other configurations available on request

### Kit consists of:

- (4) stainless steel cap screws, #1/4-20 x 3/4" L
- (4) flat washers, 1/4"
- (4) lock washers, 1/4"
- (4) nuts, 1/4"

Part Number	Description	Unit	Shipping Weight lb (kg)
40164-001	#6 AWG Ground Strap	1	1 (0.5)
40164-025	#6 AWG Ground Strap	25	12 (5.0)

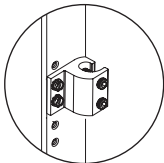
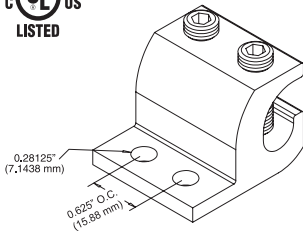

Shown mounted on rack

## Two Mounting Hole Ground Terminal Block

CPI's Two Mounting Hole Ground Terminal Block provides a convenient way to attach ground wires to racks or cabinets and meets BICSI and ANSI-J-STD-607-A two-hole mounting recommendations. Constructed of extruded, high-strength aluminum and accepts conductors ranging from #14 AWG through 2/0. Includes two #3/8-24 x 7/8" L stainless steel set screws.

- Manufactured from electroplated tin aluminum
- Available individually or in packages of 10
- Mounting hardware not included

Part Number	Description	Unit	Wire Size	Shipping Weight lb (kg)
40167-001	Two-Hole Block	1	#14-2/0	1 (0.5)
40167-010	Two-Hole Block	10	#14-2/0	10 (4.5)

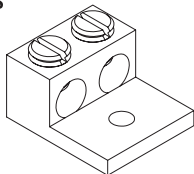

Zinc Plated

## One Mounting Hole Ground Terminal Block

CPI's traditional One Mounting Hole Ground Terminal Block provides a convenient way to attach ground wires to racks or cabinets using one #12-24 screw (not supplied). Holds up to two #4 gauge wires.

Part Number	Description	Unit	Wire Size	Shipping Weight lb (kg)
08009-001	One-Hole Block	1	Up to #4	1 (0.5)
08009-010	One-Hole Block	10	Up to #4	10 (4.5)

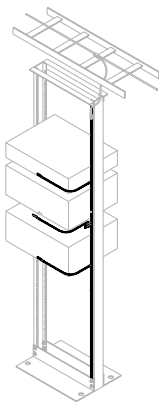
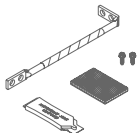

## Equipment Ground Jumper Kit

Use the Equipment Ground Jumper Kit with the Vertical Rack Busbar Kit or Rack Ground Bar Kit to bond rack-mount equipment. The Equipment Ground Jumper Kit includes a 24"L (710 mm) insulated green/yellow helical stripe #6 AWG ground conductor with a Slotted Compression Lug on one end and a 90° Slotted Compression Lug on the other. The 90° Slotted Lug attaches to the busbar or ground bar, allowing easy alignment with equipment. The Slotted Compression Lug attaches to equipment. The kit includes an abrasive pad, antioxidant joint compound and two installation screws to prepare and secure the jumper to the busbar or ground bar. The installer must provide installation hardware for the lug that attaches to equipment.

- Each kit includes one 24"L (710 mm) insulated ground jumper with attached lugs, two plated installation screws, an abrasive pad and joint compound
- The lugs are made from electroplated tinned copper and have two mounting holes spaced .5" to .625" apart that accept 1/4" screws
- UL Listed Components, File E236184, Category KDER (US), KDER7 (Canada) - Grounding and Bonding Equipment

Part Number	Description	Shipping Weight lb (kg)
40159-010	Equipment Ground Jumper Kit	2 (0.9)



## Ground Wire

Use Ground Wire to create custom-length ground jumpers to bond CPI Racks, Cabinets and Cable Runway to Telecommunications Grounding Busbars.

- Ground Wire is a #6 AWG, 133-strand, green insulated MTW conductor with a yellow helical stripe
- Sold in a 100' (30 m) length on a spool
- High strand count requires specific Compression Lugs (40162-913, 40162-963, 4012-914 or 40162-964)

Part Number	Description Length ft (m)	Shipping Weight lb (kg)
40159-001	Ground Wire, #6 AWG, 100 (30) Spool	14 (6.4)





Shown mounted on rack

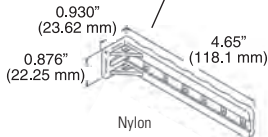
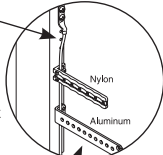

Nylon

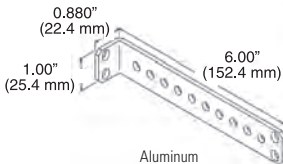

Aluminum

## Ground Jumper

Ground Jumpers provide common grounding from equipment rack or cabinet to the Telecommunications Equipment Bonding Conductor. Can be used with CPI "L" Brackets (P/N 10001-001 or 10559-500) to attach cable run vertically along equipment rack or cabinet. Ground jumpers are constructed of a 9'L (2.7 m) #6 AWG stranded copper conductor insulated green with a horizontal yellow stripe attached to a compression lug with two 1/4" bolt holes spaced on 5/8" centers.

- Available individually or in packages of 10
- Constructed of UL Listed components, File E236184, Category KDER (US), KDER7 (Canada) - Grounding and Bonding Equipment
- Replaces CPI P/N 41016-00X and 41026-00X
- Other configurations available on request

Part Number	Description Length ft (m)	Unit	Shipping Weight lb (kg)
40159-009	9 (2.7) Green Jumper	1	2 (0.9)
40159-019	9 (2.7) Green Jumper	10	20 (9.1)

## Stand-Off Tie-Down "L" Brackets

These "L" brackets mount to the back of the rack channel to provide a convenient tie-down point for grounding and bonding cable runs. Available in nonconductive nylon or high-strength aluminum construction. Either end of the aluminum bracket can be attached to the rack or cabinet face, allowing cable run in several different ways.

Part Number	Description Length ft (m)	Unit	Shipping Weight lb (kg)
10001-001	1 x 5 (30 x 130) White Nylon	1	1 (0.5)
10001-050	1 x 5 (30 x 130) White Nylon	50	3 (1.4)
10559-X00	1 x 6 (30 x 150) Aluminum	1	1 (0.5)
10559-X50	1 x 6 (30 x 150) Aluminum	50	5 (1.4)

X=color: 1=Gray, 2=Computer Beige, 5=Clear, 7=Black.

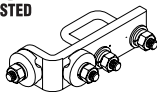

Cross Connector

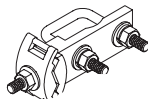
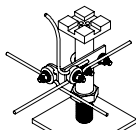

Straight Connector

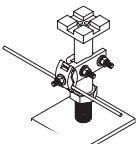

## Pedestal Clamp with Ground Connector

Support ground wires from round or square raised floor pedestals using the Pedestal Clamp with Grounding Connector. The connector provides a ground connection for the pedestal and supports up to four wires from the pedestal. Use to create a signal reference grid under the raised access floor using #6 AWG or 2/0 bare round wire.

- Use Cross Connectors to create signal reference grid intersections; support up to four conductors, two per side, size #6 AWG or 2/0
- Use Straight Connectors to support the signal reference grid in-between intersections; support one or two conductors on one side of the pedestal only, size #6 AWG or 2/0
- Manufactured from electroplated copper or bronze (P/N 40169-003) with stainless steel installation hardware
- PNs 40169-001 and 40169-002 are UL Listed, File E236184, Category KDER (US), KDER7 (Canada) - Grounding and Bonding Equipment

Part Number	Description	Pedestal Style, Diameter in (mm)	Number and Size of Connectors	Shipping Weight lb (kg)
40169-001	Pedestal Clamp, Cross Connector	Square, 1-1/8 (28) OD	(2) #6 AWG per side	2 (0.9)
40169-002	Pedestal Clamp, Cross Connector	Round, 1-1/8 (28) to 1-3/4 (44) OD	(1) #6 AWG and (1) 2/0 per side	2 (0.9)
40169-003	Pedestal Clamp, Straight Connector	Square or Round, 1-1/8 (28) OD	(2) #6 AWG or (2) 2/0 one side only	2 (0.9)

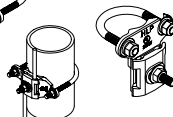
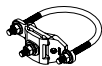
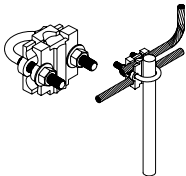

## Pipe Clamp with Ground Connector

Support ground wires from metal pipes of various sizes with the Pipe Clamp with Grounding Connector. The connector provides a ground connection for the pipe and supports up to two wires parallel or perpendicular to the pipe. Select the Pipe Clamp with Grounding Connector to match the size of the pipe.

- UL Listed, File E236184, Category KDER (US), KDER7 (Canada) - Grounding and Bonding Equipment
- Supports one or two conductors; conductors must be the same size
- Use with conductors attached in size from #6 up to 250 MCM
- Attach conductors parallel or perpendicular to the pipe
- Manufactured from electroplated tinned bronze with stainless steel hardware

Part Number	Description	Pipe Size / Diameter Ranges Nominal Size / Outside Diameter in (mm)		Shipping Weight lb (kg)
40170-001	Pipe Clamp	5-.75 (10-19)	.375-1 (9.5-30)	2 (0.9)
40170-002	Pipe Clamp	1-1.25 (30-31.8)	.75-1.7 (19-43)	2 (0.9)
40170-003	Pipe Clamp	1.5-2 (38-50)	1-2.4 (30-61)	2 (0.9)
40170-004	Pipe Clamp	2.5-3 (64-80)	2.25-3.5 (58-89)	2 (0.9)
40170-005	Pipe Clamp	3.5-4 (89-100)	3.2-4.5 (81-114)	2 (0.9)
40170-006	Pipe Clamp	5-6 (130-150)	5.63-6.63 (143-169)	2 (0.9)

*Note: P/N 40170-001 supports parallel attachment of only one conductor or perpendicular attachment of two conductors. All other clamps support parallel or perpendicular attachment of two conductors. Conductors must be the same size.*

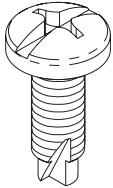

## Clean-Thread Screws

The #12-24 Combination Pan Head, Pilot Point Mounting Screws attach equipment to racks and cabinets. A cutting notch in the thread removes paint in threaded holes to improve metal-to-metal contact. The pilot point reduces cross-threading. The combination head can be used with #3 Phillips and slotted screwdrivers.

- Zinc finish
- Available in packages of 50 and 1,000

Part Number	Description	Unit	Shipping Weight lb (kg)
40605-001	#12-24 Screws	50	1 (0.5)
40605-004	#12-24 Screws	1,000	9 (4.1)

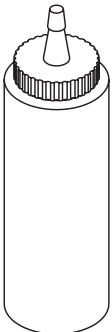

8 oz (230 g)

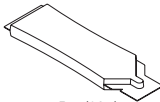

5 oz (14 g)

## Aluminum-To-Aluminum Or Aluminum-To-Copper Antioxidant Joint Compound

Recommended for all aluminum-to-aluminum and aluminum-to-copper connectors, bare conductors, Busbars, insulated conductors and conduit threads.

Part Number	Description	Size	Unit	Shipping Weight lb (kg)
40166-101	Antioxidant, Gray	.5 (14)	1	1 (0.5)
40166-801	Antioxidant, Gray	8 (230)	1	1 (0.5)
40166-150	Antioxidant, Gray	.5 (14)	50	2 (0.9)
40166-812	Antioxidant, Gray	8 (230)	12	6 (2.7)

- Oxide inhibiting joint compound is used to improve the electrical conductivity and enhance the integrity of any grounding or bonding connection
- Good for all voltages
- Assures a high-connectivity joint by sealing out air and moisture to prevent corrosion and reformation of oxide film
- Also used as an anti-seizing thread lubricant and ensures continuity of ground on aluminum conduit threads
- Bulk packaging quantities available

## Copper-To-Copper Joint Compound

Recommended for all copper-to-copper connections, copper threads and all mechanical/pressure type grounding connections.

Part Number	Description	Size	Unit	Shipping Weight lb (kg)
40168-101	Antioxidant, Copper	.5 oz	1	1 (0.5)
40168-801	Antioxidant, Copper	8 oz	1	1 (0.5)
40168-150	Antioxidant, Copper	.5 oz	50	2 (0.9)
40168-812	Antioxidant, Copper	8 oz	12	6 (2.7)



Compression Tool



Crimp Tool

## Mechanical Compression Tools

Mechanical Compression Tools are used to attach compression lugs and butt splices (not recommended for use with C-Tap connections). The tools feature long steel handles with comfortable rubber grips. The Dieless Compression Tool works with either copper or aluminum conductors. The Crimp Tool comes complete with dies and features extra-long handles for two-handed crimping.

Part Number	Description	Size	Unit	Shipping Weight lb (kg)
40165-001	Compression Tool, Dieless	Copper #8-250 MCS Aluminum #8-4/0	24 (610)	5 (2.3)
40165-002	Crimp Tool	#8-1/0	10.5 (267)	3 (1.4)



## Compression Lugs

Connect copper or tinned copper conductors to Busbars, racks, cabinets or Cable Runway.

- Manufactured from electroplated tinned copper conductors
- Available individually or in bulk quantities in three styles, Two-Hole, Slotted and 90° Slotted
- Other configurations available

Part Number	Description	Cable Size	Hole Spacing in (mm)	Hole Size in (mm)	Color Code	Quantity	Shipping Weight lb (kg)
40162-901	Two-Hole Lug	#6	.625 (15.9)	.250 (6.4)	Blue	1	1 (0.5)
40162-951	Two-Hole Lug	#6	.625 (15.9)	.250 (6.4)	Blue	50	2 (0.9)
40162-902	Two-Hole Lug	#6	.750 (19.1)	.375 (9.5)	Blue	1	1 (0.5)
40162-952	Two-Hole Lug	#6	.750 (19.1)	.375 (9.5)	Blue	50	2 (0.9)
40162-903	Two-Hole Lug	#6	1.00 (25.4)	.375 (9.5)	Blue	1	1 (0.5)
40162-953	Two-Hole Lug	#6	1.00 (25.4)	.375 (9.5)	Blue	50	2 (0.9)
40162-904	Two-Hole Lug	#2	.625 (15.9)	.250 (6.4)	Brown	1	1 (0.5)
40162-954	Two-Hole Lug	#2	.625 (15.9)	.250 (6.4)	Brown	25	2 (0.9)
40162-905	Two-Hole Lug	#2	.750 (19.1)	.375 (9.5)	Brown	1	1 (0.5)
40162-955	Two-Hole Lug	#2	.750 (19.1)	.375 (9.5)	Brown	25	2 (0.9)
40162-907	Two-Hole Lug	#2	1.00 (25.4)	.375 (9.5)	Brown	1	1 (0.5)
40162-957	Two-Hole Lug	#2	1.00 (25.4)	.375 (9.5)	Brown	25	2 (0.9)
40162-909	Two-Hole Lug	2/0	1.00 (25.4)	.375 (9.5)	Black	1	1 (0.5)
40162-959	Two-Hole Lug	2/0	1.00 (25.4)	.375 (9.5)	Black	10	2 (0.9)
40162-910	Two-Hole Lug	2/0	1.75 (44.5)	.500 (12.7)	Black	1	2 (0.9)
40162-960	Two-Hole Lug	2/0	1.75 (44.5)	.500 (12.7)	Black	10	2 (0.9)
40162-911	Two-Hole Lug	4/0	1.00 (25.4)	.375 (9.5)	Purple	1	1 (0.5)
40162-961	Two-Hole Lug	4/0	1.00 (25.4)	.375 (9.5)	Purple	10	2 (0.9)
40162-912	Two-Hole Lug	4/0	1.75 (44.5)	.500 (12.7)	Purple	1	1 (0.5)
40162-962	Two-Hole Lug	4/0	1.75 (44.5)	.500 (12.7)	Purple	10	3 (1.4)
40162-913	Slotted Lug	#6	.500 (12.7)/.625 (15.9)	.250 (6.4)	Blue	1	1 (0.5)
40162-963	Slotted Lug	#6	.500 (12.7)/.625 (15.9)	.250 (6.4)	Blue	25	2 (0.9)
40162-914	90° Slotted Lug	#6	.500 (12.7)/.625 (15.9)	.250 (6.4)	Blue	1	1 (0.5)
40162-964	90° Slotted Lug	#6	.500 (12.7)/.625 (15.9)	.250 (6.4)	Blue	25	2 (0.9)

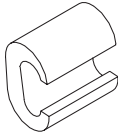

Shown connecting two copper conductors

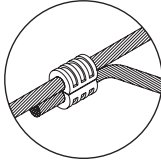

## C-Type Compression Taps

C-Type Compression Taps connect two copper conductors with the use of a hydraulic crimping tool.

- Available individually or in bulk packages
- Other sizes available on request
- UL Listed

Part Number	Description	Run	Tap	Unit	Shipping Weight lb (kg)
40163-004	C Taps	#2 Stranded #2 Solid	#2 Stranded #2 Solid	1	1 (0.5)
40163-054	C Taps	#2 Stranded #2 Solid	#2 Stranded #2 Solid	50	4 (1.8)
40163-003	C Taps	#2 Stranded #2 Solid	#4 Stranded #8 Solid	1	1 (0.5)
40163-053	C Taps	#2 Stranded #2 Solid	#4 Stranded #8 Solid	50	6 (2.7)
40163-002	C Taps	#4 Stranded #4 Solid	#4 Stranded #6 Solid	1	1 (0.5)
40163-052	C Taps	#4 Stranded #4 Solid	#4 Stranded #6 Solid	50	3 (1.4)
40163-001	C Taps	#4 Stranded #6 Solid	#6 Stranded #6 Solid	1	1 (0.5)
40163-051	C Taps	#4 Stranded #6 Solid	#6 Stranded #6 Solid	50	3 (1.4)
40163-005	C Taps	2/0 Stranded 1/0 Solid	#2 Stranded #8 Solid	1	1 (0.5)
40163-055	C Taps	2/0 Stranded 1/0 Solid	#2 Stranded #8 Solid	10	1 (0.5)
40163-007	C Taps	2/0 Stranded 1/0 Solid	2/0 Stranded 1/0 Solid	1	1 (0.5)
40163-057	C Taps	2/0 Stranded 1/0 Solid	2/0 Stranded 1/0 Solid	10	1 (0.5)
40163-006	C Taps	4/0 Stranded 3/0 Solid	#2 Stranded #6 Solid	1	1 (0.5)
40163-056	C Taps	4/0 Stranded 3/0 Solid	#2 Stranded #6 Solid	10	1 (0.5)
40163-008	C Taps	4/0 Stranded 3/0 Solid	2/0 Stranded 1/0 Solid	1	1 (0.5)
40163-058	C Taps	4/0 Stranded 3/0 Solid	2/0 Stranded 1/0 Solid	10	2 (0.9)
40163-009	C Taps	4/0 Stranded 3/0 Solid	4/0 Stranded 3/0 Solid	1	1 (0.5)
40163-059	C Taps	4/0 Stranded 3/0 Solid	4/0 Stranded 3/0 Solid	10	2 (0.9)

# KVM SYSTEMS

Keyboard, video, Monitor System & Accessories



7" LCD KVM Drawer

Analog KVM Switch with DB15 Ports

IP KVM Switch with DB15 Ports

IP KVM Switch with Cat 5/6 Ports

KVM Switch Accessories

Page 6-3

Page 6-5

Page 6-7

Page 6-9

Page 6-12

# KVM SYSTEMS

CPI provides space-saving, scalable and fully integrated KVM Systems with optional IP capability. KVM Systems provide convenient console and IP access to servers.

## **KVM Systems include:**

- Analog and IP KVM with DB15 Ports
- Compact, simple and cost-effective single-user keyboard, video and mouse (KVM) switching solutions for small and medium-sized computer rooms
- Access up to 16 computers per switch and 128 with expansion switches
- View computers from the rack-mount drawer
- View computers over the IP network using a web browser with IP KVM Switch and DB15 Ports
- Transfer between computers with intuitive, on-screen menu or keyboard hot keys

## **KVM over IP with Cat 5/6 Ports:**

- Enterprise class, multi-user KVM switches
- Access up to 32 computers per switch and 256 with expansion switches
- View computers from the rack-mount drawer, a remote computer or over the IP network using a web browser
- Transfer between computers with intuitive, on-screen menu or keyboard hot keys



37200-111



37201-111

## 17" LCD KVM DRAWER

The 17" LCD KVM Drawer is a combination LCD flat panel display, keyboard and touchpad console that uses only 1U of rack-mount space. Use the space-saving 17" LCD KVM Drawer in 4-post racks and cabinets to provide easy access to rack-mount equipment.

The 17" LCD KVM Drawer includes a 17" TFT LCD color display, a full size keyboard with separate number pad and an integrated touchpad. Both U.S. and UK keyboard layouts are available. The drawer has a single HD15 connector and includes a Combo KVM Cable with connections for VGA video and PS/2, as well as USB keyboard and mouse, allowing one cable to connect all types of equipment. The display supports a wide range of resolutions to match most PC, MAC, SUN, IBM, HP and Dell computers. A wide viewing angle and good contrast create a crisp, clear image.

Two drawer styles are available: single and dual rail. The single rail model features a laptop-style design where the keyboard and panel are hinged, and the LCD panel pivots open. On the dual rail model, the keyboard tray and panel are separate, which allow the LCD panel to be left in the open position when the keyboard tray is closed.

The 17" LCD KVM Drawer is part of a complete solution that includes KVM Switches, which provide access to multiple computers from a single set of peripherals.

### Features:

- Combination rack-mount LCD panel, keyboard and touchpad drawer
- For 19"EIA cabinets, uses only 1U of rack-mount space
- Single or dual rail models; dual rail model allows the display to remain open when the keyboard tray is closed
- 17" industrial TFT LCD display
- U.S. or UK keyboard layouts with integrated touchpad
- Supports VGA video connection and PS/2 or USB keyboard and mouse connections
- Three-piece mounting rails allow easy one-person installation
- Keyboard locks in the open position to prevent movement when typing
- Also available with an integrated KVM Switch

Part Number		Description	Shipping Weight lb (kg)
U.S. Keyboard	UK Keyboard		
37200-111	37200-112	Single Rail LCD KVM Drawer	43 (19.5)
37201-111	37201-112	Dual Rail LCD KVM Drawer	43 (19.5)

*Note: The U.S. and UK keyboards have the same keys but locations of some symbol keys are different. Additionally, the UK keyboard includes a key for the Pound Symbol. The part numbers listed above do not include a KVM switch.*



# 17" LCD KVM DRAWER

## Specifications:

- Combination rack-mount LCD flat panel monitor, keyboard and touchpad console
- For indoor use only, in environmentally controlled areas; may not be used outdoors, in harsh environments or in air-handling spaces
- Dimensions:
  - 1.73"H x 17.4"W x 25.6"D (44 mm x 442 mm x 650 mm)
- Rack-Mount Size: 1U x 19"EIA x 25.6"D (650 mm)
- 17" LCD monitor with TFT color display
- U.S. or UK keyboard layout with Integrated touchpad
- Compatibility: Multi-platform, PC, MAC, SUN, IBM, HP and Dell
- Display specifications:
  - Brightness (cd/m<sup>2</sup>): 250
  - Color Support: 16.7 M
  - Contrast Ratio (typ.): 1000:1
  - Viewing Angle (H/V): 160° x 160°
  - Display Area (mm): 338 x 270
  - Tr Response Time (ms): 1.3
  - LCD Panel MTBF (hrs): 50,000
  - VGA Signal Input: Analog RGB, 0.7Vp-p
  - Sync. Type: Separate H/V, Composite, SOG
- Supports Screen Resolutions:
  - 720 x 400, 70 Hz
  - 640 x 480, 60/70/72/75 Hz
  - 800 x 600, 60/70/72/75 Hz
  - 1024 x 768, 60/70/75 Hz
  - 1152 x 864, 60/70/75 Hz
- 1280 x 720, 60/70/75 Hz
- 1280 x 1024, 60/70/72/75 Hz
- Input Connector:
  - (1) HD15, 15-pin connector
- Electrical:
  - Power Input: Auto-sensing 100 to 240 VAC, 50/60 Hz
  - Power Consumption: Max. 48 Watt, Standby 5 Watt
  - Power Inlet: (1) IEC60320 C-14
- Environmental:
  - Operation: 32-122°F (0-50°C)
  - Storage: 23-140°F (-5-60°C)
  - Relative Humidity: 5%-90%, non-condensing
  - Shock: 10G acceleration (11 ms duration)
  - Vibration: 5-500Hz 1G RMS random vibration
- Regulation Approval:
  - FCC, CE (all)
- Select models are UL Listed: File E212076; Category NWGO (US), Information Technology Equipment including Electrical Business Equipment (P/Ns 37200-111 and 37200-112).
- Includes Rack/Cabinet Mounting Brackets:
  - Requires four-point (front/rear) support
  - Maximum rack/cabinet front/rear rail-to-rail depth is 35.5" (900 mm)
- Includes Cables:
  - (1) 6'L (1.8 m) IEC60320 C-13 to NEMA 5-15P power cord
  - (1) 6'L (1.8 m) HD15 to VGA/PS2/USB Combo KVM Cable
- Finish: Black only

## System Diagram:

Front view: 17" LCD KVM Drawer

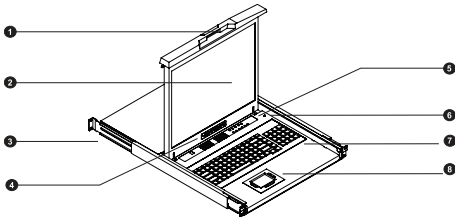

1. Carry handle to release the 2-pt lock
2. 17" LCD TFT display panel
3. Rack-Mount Rails
4. LCD Adjustment Buttons
5. KVM Switch Adjustment Buttons (only on models with KVM Switch)
6. Micro switch for screen auto power off
7. Keyboard
8. Touchpad



Single-Rail, 17" LCD KVM Drawer

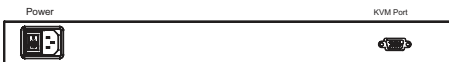

Back view: P/N 37200-111, 37200-112, 37201-111 and 37201-112.

Technical Data Sheet and User Manual illustrate cable diagrams. Go to [www.chatsworth.com/products/KVM-systems](http://www.chatsworth.com/products/KVM-systems) to download.



37203-161,  
17" LCD KVM  
Drawer and  
Analog Switch



37202-160, Analog  
KVM Switch

## Analog KVM Switch with DB15 Ports

The Analog KVM Switch with DB15 ports provides basic, single-user access to 16 computers from a single set of peripherals and uses only 1U of rack-mount space. The Analog KVM Switch is an excellent solution for small and medium single-site facilities. It features a 16-port analog KVM switch that can be expanded with up to seven additional standalone switches to connect up to 128 computers. Available as a standalone switch or combined with a 17" LCD KVM Drawer.

The Analog KVM Switch supports eight password protected user accounts for added security and allows the user to easily transfer between computers with an intuitive on-screen menu or keyboard hotkeys. Individual user access can be assigned by port, and each port can be named with the computer name, simplifying equipment identification. Additionally, LEDs, which indicate port connection status and buttons that allow manual switching between computers, are on the front panel or the keyboard tray.

The 17" LCD KVM Drawer and Analog Switch includes a 17" TFT LCD color display, a full size keyboard with separate number pad and an integrated touchpad. The display supports a wide range of resolutions to match most PC, MAC, SUN, IBM, HP and Dell computers. The single rail model features a laptop-style design, where the keyboard and panel are hinged, and the LCD panel pivots open. On the dual rail model, the keyboard tray and panel are separate, which allow the LCD panel to be left in the open position when the keyboard tray is closed.

### Features:

- Rack-mount Analog KVM (keyboard, video, mouse) switch
- For 19" EIA cabinets, uses only 1U of rack-mount space
- Connect 16 computers through one set of peripherals
- Multi-platform switch, supports VGA video connection and PS/2 or USB keyboard and mouse connections
- Easy switching between computers with buttons, hotkeys or on-screen display
- Password protected access and eight user accounts
- LEDs to indicate computer connections
- Expand by connecting up to eight switches together to access 128 computers from a single set of peripherals
- Also available with an integrated 17" LCD KVM Drawer
- Drawer available in single or dual rail models with U.S. or UK keyboard layouts

*Note: Connect the Analog KVM Switch to each computer with a Combo KVM Cable, or expand the number of ports by connecting another switch with a Cascade Cable. Each switch has 16 DB15 computer ports and one DB15 cascade expansion port.*

*Combo KVM Cables feature a VGA video connection and combination PS/2 and USB keyboard and mouse connections, so one type of cable connects all types of equipment. Order cables separately: one Combo KVM Cable per computer and one Cascade Cable per expansion switch.*

Part Number		Description	Shipping Weight lb (kg)
U.S. Keyboard	UK Keyboard		
37203-161	37203-162	Single Rail, 17" LCD KVM Drawer and Analog Switch, 16 DB15 ports, no IP Console	53 (24.1)
37204-161	37204-162	Dual Rail, 17" LCD KVM Drawer and Analog Switch, 16 DB15 ports, no IP Console	53 (24.1)
Analog KVM Switch			
37202-160		Analog KVM Switch, 16 DB15 ports, 1 Local, no IP Console	10 (4.5)

# ANALOG KVM SWITCH WITH DB15 PORTS

## Specifications:

- Rack-mount 16-port analog KVM switch
- For indoor use only, in environmentally controlled areas; may not be used outdoors, in harsh environments or in air-handling spaces
- Dimensions:
  - Switch: 1U x 19"EIA, 1.73"H x 17.6"W x 7.1"D (44 mm x 446 mm x 180 mm)
  - Drawer: 1U x 19"EIA, 1.73"H x 17.4"W x 25.6"D (44 mm x 442 mm x 650 mm)
- KVM Ports:
  - (16) DB-15 combo connector
  - Requires Combo KVM Cables (P/N 37208-161, -111), ordered separately
- KVM Management:
  - Multilingual OSD: English, French, German, Spanish, Italian, Russian, Simplified Chinese, Japanese
  - Hotkey combinations: Scroll-lock, Cap-lock, Num-lock, Alt, Ctrl & Win
  - Security: Password enable and disable, up to eight user profiles for port access
  - PC Selection: Front button, OSD menu, hotkey
- KVM Expansion:
  - Up to 128 servers by eight level cascade
  - Requires a Cascade Cable (P/N 37208-162), ordered separately
- KVM Compatibility:
  - Multi-platform: PC, MAC, SUN, IBM, HP and Dell
  - Support: Windows Vista/2003/XP/2000, Linux, Netware, Unix
- Drawer
  - 17" LCD monitor with TFT color display
  - U.S. or UK keyboard layout
  - Integrated touchpad
  - KVM port status LEDs and buttons
- Display specifications
  - Brightness (cd/m<sup>2</sup>): 250
- Color Support: 16.7 M
- Contrast Ratio (typ.): 1000:1
- Viewing Angle (H/V): 160° x 160°
- Display Area (mm): 338 x 270
- Tr Response Time (ms): 1.3
- LCD Panel MTBF (hrs): 50,000
- VGA Signal Input: Analog RGB, 0.7Vp-p
- Sync. Type: Separate H/V, Composite, SOG
- Supports Screen Resolutions:
  - 720 x 400, 70 Hz
  - 640 x 480, 60/70/72/75 Hz
  - 800 x 600, 60/70/72/75 Hz
  - 1024 x 768, 60/70/75 Hz
  - 1152 x 864, 60/70/75 Hz
  - 1280 x 1024, 60/70/72/75 Hz
- Electrical:
  - Power Input: Auto-sensing 100 to 240 VAC, 50/60 Hz
  - Power Consumption: Max. 48 Watt, Standby 5 Watt
  - Power Inlet: (1) IEC60320 C-14
- Environmental:
  - Operation: 32-122°F (0-50°C)
  - Storage: 23-140°F (-5-60°C)
- Regulation Approval:
  - FCC, CE (all)
- Select models are UL Listed: File E212076; Category NWGQ (US), Information Technology Equipment including Electrical Business Equipment (P/Ns 37203-161 and 37203-162).
- Includes Rack/Cabinet Mounting Brackets:
  - Switch: Requires front only support
  - Drawer: Requires front and rear support, maximum rail depth is 35.5" (900 mm)
- Includes Cables:
  - (1) 6'L (1.8 m) IEC60320 C-13 to NEMA 5-15P power cord
- Finish: Black only

## System Diagram:

Front view: 17" LCD KVM Drawer & Switch

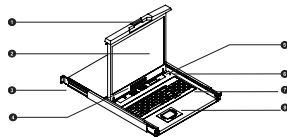

1. Carry handle to release the 2-nd lock
2. 17" LCD TFT display panel
3. Rack-Mount Rails
4. LCD Adjustment Buttons
5. KVM Switch Adjustment Buttons
6. Micro switch for screen auto power off
7. Keyboard
8. Touchpad

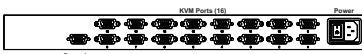

**Back view:** P/N 37203-161, 37203-162, 37204-161, 37204-162 – no local console (drawer is local console), no remote console, no IP console, 16 DB15 server connections, 1 DB15 cascade connection (use Cascade Cable P/N 37208-162)

Front view: Analog KVM Switch



LED indicators for connection and active port and buttons to manually switch port

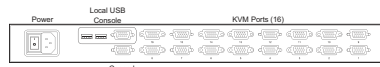

**Back view:** P/N 37202-160 – 1 local console, no remote console, no IP console, 16 DB15 server connections, 1 DB15 cascade connection (use Cascade Cable P/N 37208-162)

Technical Data Sheet and User Manual illustrate cable diagrams. Go to [www.chatsworth.com/products/KVM-systems](http://www.chatsworth.com/products/KVM-systems) to download.



37209-261, 17" LCD KVM Drawer and IP Switch



37212-260, IP KVM Switch with DB15 ports

## IP KVM Switch with DB15 Ports

The IP KVM Switch with DB15 computer ports provides basic, single-user access to 16 computers from a single set of peripherals or a network connection and uses only 1U of rack-mount space. The IP KVM Switch with DB15 computer ports is an excellent solution for small and medium single-site facilities.

Drawer and Switch combination feature an LCD flat panel display, keyboard and touchpad console and a 16-port IP KVM switch that can be expanded with up to seven additional standalone switches to connect up to 128 computers.

The IP KVM Switch with DB15 ports features two user interfaces: the local console and an IP connection accessed through the network using a Java-enabled web browser. The local console supports eight password protected user accounts for added security. Individual user access can be assigned by port, and each port can be named with the computer name, simplifying equipment identification. Similarly, the IP connection supports one active user and fifteen password protected user accounts with user or administrator roles and keeps an event log for added security.

The 17" LCD KVM Drawer includes a 17" TFT LCD color display, a full size keyboard with separate number pad and an integrated touchpad. It features a laptop-style design, where the keyboard and panel are hinged, and the LCD panel pivots open. Both U.S. and UK keyboard layouts are available. The display supports a wide range of resolutions to match most PC, MAC, SUN, IBM, HP and Dell computers.

### Features:

- Rack-mount IP KVM (keyboard, video, mouse) Switch
- For 19" EIA cabinets, uses only 1U of rack-mount space
- Connect 16 computers through one set of peripherals or IP connection
- Multi-platform switch, supports VGA video connection and PS/2 or USB keyboard and mouse connections
- Easy switching between computers with buttons, hotkeys or on-screen display
- Password protected access and eight user accounts
- LEDs to indicate computer connections
- Expand by connecting up to seven additional standalone KVM expansion switches to access 128 computers from a single set of peripherals
- Also available with an integrated 17" LCD KVM Drawer
- Drawer available in single rail model with U.S. or UK keyboard layouts

*Note: Connect the IP KVM Switch with DB15 ports to each computer with a Combo KVM Cable, or expand the number of ports by connecting another switch with a Cascade Cable. Each switch has 16 DB15 computer ports and one DB15 cascade expansion port.*

*Combo KVM Cables feature a VGA video connection and combination PS/2 or USB keyboard and mouse connections, so one type of cable connects all types of equipment. Order cables separately: one Combo KVM Cable per computer and one Cascade Cable per expansion switch.*

Part Number		Description	Shipping Weight lb (kg)
U.S. Keyboard	UK Keyboard		
37209-261	37209-262	Single Rail, 17" LCD KVM Drawer and IP Switch, 16 DB15 ports, 1 IP Console	53 (24.1)
<b>IP KVM Switch</b>			
37212-260		IP KVM Switch, 16 DB15 ports, 1 Local, 1 IP Console	10 (4.5)
<b>Expansion Switch</b>			
37202-160		Analog KVM Switch, 16 DB15 ports, 1 Local, no IP Console	10 (4.5)

# ANALOG KVM SWITCH WITH DB15 PORTS

## Specifications:

- Rack-mount 16-port IP KVM switch
- For indoor use only, in environmentally controlled areas; may not be used outdoors, in harsh environments or in air-handling spaces
- Dimensions:
  - Switch: 1U x 19"EIA, 1.73"H x 17.6"W x 7.1"D (44 mm x 446 mm x 180 mm)
  - Drawer: 1U x 19"EIA, 1.73"H x 17.4"W x 25.6"D (44 mm x 442 mm x 650 mm)
- KVM Ports:
  - (16) DB-15 combo connector
  - Requires Combo KVM Cables (P/N 37208-161, -111), ordered separately
- KVM Management:
  - Multilingual OSD: English, French, German, Spanish, Italian, Russian, Simplified Chinese, Japanese
  - Hotkeys: Scroll-lock, Cap-lock, Num-lock, Alt, Ctrl & Win
  - Security: Password enable and disable, up to eight user profiles for port access
  - PC Selection: Front button, OSD menu, hotkey
- IP Console:
  - (1) RJ45 (8P8C) Ethernet, 10/100 Mbps
  - (1) RJ45 serial
  - (1) USB
- IP Security:
  - SSL v 3, RSA, AES, CSR, http & https Internet access
  - Fifteen user profiles (one active user)
- KVM Expansion:
  - Up to 128 servers by eight level cascade
  - Requires a Cascade Cable (P/N 37208-162), order separately
- KVM Compatibility:
  - Multi-platform: PC, MAC, SUN, IBM, HP and Dell
  - Support: Windows Vista/2003/XP/2000, Linux, Netware, Unix
- Drawer:
  - 17" LCD monitor with TFT color display
  - US or UK keyboard layout, integrated touchpad
  - KVM port status LEDs and buttons
- Display specifications
  - Brightness (cd/m<sup>2</sup>): 250
  - Color Support: 16.7 M
  - Contrast Ratio (typ.): 1000:1
  - Viewing Angle (H/V): 160° x 160°
  - Display Area (mm): 338 x 270
  - Tr Response Time (ms): 1.3
  - LCD Panel MTBF (hrs): 50,000
  - VGA Signal Input: Analog RGB, 0.7Vp-p
  - Sync. Type: Separate H/V, Composite, SOG
- Supports Screen Resolutions:
  - 720 x 400, 70 Hz
  - 640 x 480, 60/70/72/75 Hz
  - 800 x 600, 60/70/72/75 Hz
  - 1024 x 768, 60/70/75 Hz
  - 1152 x 864, 60/70/75 Hz
  - 1280 x 1024, 60/70/72/75 Hz
- Electrical:
  - Power Input: Auto-sensing 100 to 240 VAC, 50/60 Hz
  - Power Consumption: Max. 24 Watt, Standby 5 Watt
  - Power Inlet: (1) IEC60320 C-14
- Environmental:
  - Operation: 32-122°F (0-50°C)
  - Storage: 23-140°F (-5-60°C)
- Regulation Approval:
  - FCC, CE (all)
- Select models are UL Listed: File E212076; Category NWGQ (US), Information Technology Equipment including Electrical Business Equipment (P/Ns 37209-261 and 37209-262).
- Includes Rack/Cabinet Mounting Brackets:
  - Switch: Requires front only support
  - Drawer: Requires front and rear support, maximum rail depth is 35.5"(900 mm)
- Includes Cables:
  - (1) 6'L (1.8 m) IEC60320 C-13 to NEMA 5-15P power cord
- Finish: Black only

## System Diagram:

Front view: 17" LCD KVM Drawer & IP Switch

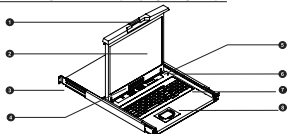

1. Carry handle to release the 2-qt lock
2. 17" LCD TFT display panel
3. Rack-Mount Rails
4. LCD Adjustment Buttons
5. KVM Switch Adjustment Buttons
6. Micro switch for screen auto power off
7. Keyboard
8. Touchpad

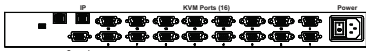

**Back view:** P/N 37209-261, 37209-262 – no local console (drawer is local console), no remote console, 1 IP console, 16 DB15 server connections, 1 DB15 cascade connection (use Cascade Cable P/N 37208-162)

Front view: IP KVM Switch



LED indicators for connection and active port and buttons to manually switch port

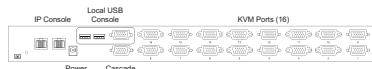

**Back view:** P/N 37212-260 – 1 local console, no remote console, 1 IP console, 16 DB15 server connections, 1 DB15 cascade connection (use Cascade Cable P/N 37208-162)

Technical Data Sheet and User Manual illustrate cable diagrams. Go to [www.chatsworth.com/products/KVM-systems](http://www.chatsworth.com/products/KVM-systems) to download.



37205-361, 17" LCD  
KVM Drawer and IP  
Switch with Cat 5/6  
ports



IP KVM Switch  
with Cat 5/6 ports.

## IP KVM Switch with Cat 5/6 Ports

The IP KVM Switch with Cat 5/6 computer ports provides multi-user access to 16 or 32 computers from local console, a remote console or over the Ethernet using a Java-enabled web browser. The IP KVM Switch is an excellent solution for IT staff that require both local and remote access to equipment. It features a 16-port or 32-port IP switch that can be expanded with up to seven additional switches to connect up to 256 computers through the local and remote console and a single IP address.

The IP KVM Switch with Cat 5/6 ports features multiple user interfaces: the local console, a remote console to connect to another computer located on site and one or two IP connections accessed through the network using a Java-enabled web browser. Expansion switches are also available without IP connections. The local and remote consoles support eight password protected user accounts for added security. Individual user access can be assigned by port, and each port can be named with the computer name, simplifying equipment identification. Additionally, LEDs, which indicate port connection status and buttons that allow manual switching between computers, are on the front panel or the keyboard tray. Similarly, each IP connection supports one active user and fifteen password protected user accounts with user or administrator roles and keeps an event log for added security.

The 17" LCD KVM Drawer and IP Switch includes a 17" TFT LCD color display, a full size keyboard with number pad and an integrated touchpad. The display supports a wide range of resolutions to match most PC, MAC, SUN, IBM, HP and Dell computers.

### Features:

- Rack-mount IP KVM (keyboard, video, mouse) Switch
- For 19"EIA cabinets, uses only 1U of rack-mount space
- Access 16 or 32 computers through one set of peripherals, a remote console or an IP network
- Multi-platform switch, supports VGA video connection and PS/2 or USB keyboard and mouse connections
- Easy switching between computers with buttons, hotkeys or on-screen display
- Password protected IP access, 15 user accounts, assign administrator or user roles, select models support two simultaneous users
- LEDs to indicate computer connections
- Expand by connecting up to eight switches together to access 128 or 256 computers from a single set of peripherals, a remote console or the IP connection
- Also available with an integrated 17" LCD KVM Drawer
- Drawer available in single or dual rail models with U.S. or UK keyboard layouts

# IP KVM SWITCH-CAT 5/6 PORTS



Part Number		Description	Shipping Weight lb (kg)
U.S. Keyboard	UK Keyboard		
37205-361	37205-362	Single Rail, 17" LCD KVM Drawer and IP Switch, 16 Cat 5/6 ports, 1 Remote, 1 IP Console	50 (22.7)
37205-421	37205-422	Single Rail, 17" LCD KVM Drawer and IP Switch, 32 Cat 5/6 ports, 1 Remote, 2 IP Consoles	53 (24.1)
37206-361	37206-362	Dual Rail, 17" LCD KVM Drawer and IP Switch, 16 Cat 5/6 ports, 1 Remote, 1 IP Console	50 (22.7)
37206-421	37206-422	Dual Rail, 17" LCD KVM Drawer and IP Switch, 32 Cat 5/6 ports, 1 Remote, 2 IP Consoles	53 (24.1)
IP KVM Switch with CAT 5/6 Ports			
37207-360		IP KVM Switch, 16 Cat 5/6 ports, Local, 1 Remote, 1 IP Console	9 (4.1)
37207-420		IP KVM Switch, 32 Cat 5/6 ports, 1 Local, 1 Remote, 2 IP Consoles	12 (5.5)
Expansion Switch			
37210-260		Analog KVM Switch, 16 Cat 5/6 ports, 1 Local, 1 Remote, no IP Console	8 (3.6)
37210-220		Analog KVM Switch, 32 Cat 5/6 ports, 1 Local, 1 Remote, no IP Console	12 (5.5)

## Specifications:

- Rack-mount 16-port or 32-port IP KVM (keyboard, video, mouse) Switch with Cat 5/6 ports
- For indoor use only, in environmentally controlled areas; may not be used outdoors, in harsh environments or in air-handling spaces
- Dimensions:
  - Switch: 1U x 19"EIA, 1.73"H x 17.6"W x 7.1"D (44 mm x 446 mm x 180 mm)
  - Drawer: 1U x 19"EIA, 1.73"H x 17.4"W x 25.6"D (44 mm x 442 mm x 650 mm)
- KVM Ports:
  - (16) or (32) RJ45 (8P8C) connectors
  - Use Cat6 or Cat5 cable for server connections, up to 132 ft (40 m)
  - Requires VGA-USB dongle (P/N 37208-103) or VGA-PS/2 dongle (P/N 37208-104) to connect computers
- KVM Management:
  - Multilingual OSD: English, French, German, Spanish, Italian, Russian, Simplified Chinese, Japanese
  - Security: Password enable and disable, up to 8 user profiles for port access
  - PC Selection: Front button, OSD menu, hotkey

- IP Console:
  - (1) or (2) RJ45 Ethernet
  - (1) or (2) RJ45 serial
  - (1) or (2) USB
- IP Security:
  - SSL v3, RSA, AES, CSR, http & https internet access
  - Fifteen user profiles (one active user) per IP Console
- Remote Console:
  - (1) RJ45
  - Use Cat6 or Cat5 UTP cable for server connection, up to 500 ft (150 m)
  - Includes remote receiver, Combo KVM Cable for remote computer, and power supply
- KVM Expansion:
  - 16-port models: up to 128 servers by eight level cascade
  - 32-port models: up to 256 servers by eight level cascade
  - Requires Cascade Cable (P/N 37208-165), ordered separately
- KVM Compatibility:
  - Multi-platform: PC, MAC, SUN, IBM, HP and Dell
  - Support: Windows Vista/2003/XP/2000, Linux, Netware, Unix
- KVM Drawer:
  - 17" LCD monitor with TFT color display
  - US or UK keyboard layout, integrated touch pad
  - KVM port status LEDs and buttons

- Display specifications:
  - Brightness (cd/m<sup>2</sup>): 300 (single), 250 (dual)
  - Color Support: 16.7 M
  - Contrast Ratio (typ.): 1000:1
  - Viewing Angle (H/V): 160° x 160°
  - Display Area (mm): 338 x 270
  - Tr Response Time (ms): 1.3
  - LCD Panel MTBF (hrs): 50,000
  - VGA Signal Input: Analog RGB, 0.7Vp-p
  - Sync. Type: Separate H/V, Composite, SOG

Specifications continued on next page.

- Supports Screen Resolutions:
  - 720 x 400, 70 Hz
  - 640 x 480, 60/70/72/75 Hz
  - 800 x 600, 60/70/72/75 Hz
  - 1024 x 768, 60/70/75 Hz
  - 1152 x 864, 60/70/75 Hz
  - 1280 x 1024, 60/70/72/75 Hz

- Electrical:
  - Power Input: Auto-sensing 100 to 240 VAC, 50/60 Hz
  - Power Consumption: Max. 24 Wwatt, Standby 5 Watt
  - Power Inlet: (1) IEC60320 C-14
- Environmental:
  - Operation: 32-122°F (0-50°C)
  - Storage: 23-140°F (-5-60°C)
  - Relative Humidity: 90%, non-condensing- Shock: 50G acceleration (11 ms, half-sine wave)
  - Vibration: 58-100Hz / 0.98G (11 ms / cycle)
- Regulation Approval:
  - FCC, CE
- Includes Rack/Cabinet Mounting Brackets:
  - Switch: Requires front only support
  - Drawer: Requires front and rear support, maximum rail depth is 35.5" (900 mm)
- Included Cables:
  - (1) 6'L (1.8 m) IEC60320 C-13 to NEMA 5-15P power cord
- Finish: Black only

## System Diagram:

Front view: 17" LCD KVM Drawer & IP Switch - 16-Port and 32 Port:

16 Port P/Ns: 37205-361, 37205-362, 37206-361, 37206-362  
 32 Port P/Ns: 37205-421, 37205-422, 37206-421, 37206-422

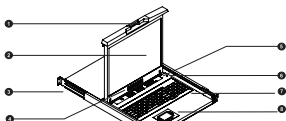

1. Carry handle to release the 2-pc lock
2. 17" LCD TFT display panel
3. Rack-Mount Rails
4. LCD Adjustment Buttons
5. KVM Switch Adjustment Buttons
6. Micro switch for screen auto power off
7. Keyboard
8. Touchpad

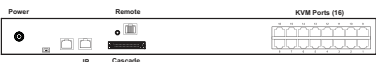

Back view: P/N 37205-361, 37205-362, 37206-361, 37206-362 – no local console (drawer is local console), 1 remote console, 1 IP console, 16 RJ45 (8P8C) server connections, 1 cascade connection (use Cascade Cable P/N 37208-165)

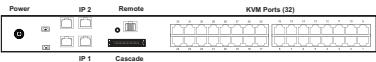

Back view: P/N 37205-421, 37205-422, 37206-421, 37206-422 – no local console (drawer is local console), 1 remote console, 2 IP consoles, 32 RJ45 (8P8C) server connections, 1 cascade connection (use Cascade Cable P/N 37208-165)

## Front view: IP KVM Switch-16-Port:



37207-360, 37210-260 – LED indicators for connection, local and remote active ports and buttons to manually switch ports

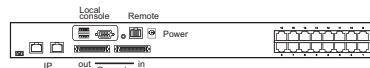

Back view: P/N 37207-360 – 1 local console, 1 remote console, 1 IP console, 16 RJ45 (8P8C) server connections, 1 cascade connection (use Cascade Cable P/N 37208-165)

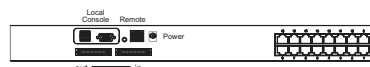

Back view: P/N 37210-260 (Expansion switch) – 1 local console, 1 remote console, No IP console, 16 RJ45 (8P8C) server connections, 1 cascade connection (use Cascade Cable P/N 37208-165)

## Front view: IP KVM Switch-32-Port:



P/N 37207-420, 37210-220 – LED indicators for connection, local and remote active ports and buttons to manually switch ports

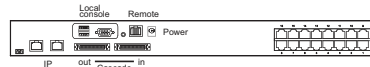

Back view: P/N 37207-420 – 1 local console, 1 remote console, 2 IP consoles, 32 RJ45 (8P8C) server connections, 1 cascade connection (use Cascade Cable P/N 37208-165)

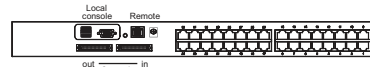

Back view: P/N 37210-220 (Expansion switch) – 1 local console, 1 remote console, no IP console, 32 RJ45 (8P8C) server connections, 1 cascade connection (use Cascade Cable P/N 37208-165).

Technical Data Sheet and User Manual illustrate cable diagrams. Go to [www.chatsworth.com/products/KVM-systems](http://www.chatsworth.com/products/KVM-systems) to download.





37208-161



37208-162



37208-103



37208-165

*Note: Use the VGA-USB dongle (P/N 37208-103) with server computers that have a VGA video and USB mouse and keyboard connectors. The VGA-USB dongle is also available in a pack of eight (P/N 37208-803) or a pack of 16 (P/N 37208-603).*

*Use the VGA-PS2 dongle (P/N 37208-104) with server computers that have a VGA video and PS/2 keyboard and mouse connectors. The VGA-PS2 dongle is also available in a pack of eight (P/N 37208-804) or a pack of 16 (P/N 37208-604).*

## Combo KVM Cables for KVM Switches with DB15 Ports

Use Combo KVM Cables to attach computers to the KVM Switch with DB15 ports. Each cable can connect one computer with PS/2 or USB keyboard and mouse connections. The cable has a combination DB-15 connector on the switch end and three breakout cables on the other end for computer connections. The breakout side includes one HD-15 connector for VGA video, one PS/2 connector and one USB connector. The system includes a USB-to-PS/2 converter for systems with PS/2 keyboard and mouse.

## Cascade Cable for KVM Switches with DB15 Ports

Use the Cascade Cable to connect two switches together for expansion. Computers connected to both switches will be viewed through one set of peripherals. Each Cascade Cable has a combination DB-15 connector on each end.

## IP KVM Cable Dongles for KVM Switches with Cat 5/6 Ports

Use IP KVM Cable Dongles to connect computers to the IP KVM Switch Cat 5/6 ports with Cat 5/6 cables (ordered separately). The dongle has an RJ45 (8P8C) connector for the Cat 5/6 cable from the switch on one end and computer video, keyboard and mouse connectors on the other end. Select the dongle to match keyboard and video connection: USB or PS/2.

## Cascade Cable for KVM Switches with Cat 5/6 Ports

Use the Cascade Cable to connect two switches together for expansion. Computers connected to both switches will be viewed through one set of peripherals, the remote console or the IP connection on the first switch.

Part Number	Description Length ft (m)	Shipping Weight lb (kg)
<b>KVM with DB15 Ports</b>		
37208-161	Combo KVM Cable, 6'L (1.8 m)	3 (1.4)
37208-111	Combo KVM Cable, 10'L (3.0 m)	3 (1.4)
37208-861	Combo KVM Cable, 6'L (1.8 m), Pack of 8	5 (2.3)
37208-811	Combo KVM Cable, 10'L (3.0 m), Pack of 8	7 (3.2)
37208-661	Combo KVM Cable, 6'L (1.8 m), Pack of 16	8 (3.6)
37208-611	Combo KVM Cable, 10'L (3.0 m), Pack of 16	12 (5.4)
37208-621	Combo cables, 10 each 6'L (1.8 m) and 6 each 10'L (3.0 m)	12 (5.4)
37208-162	Cascade Cable, 6'L (1.8 m)	3 (1.4)
<b>KVM with Cat 5/6 Ports</b>		
37208-103	Cable Dongle, VGA-USB	3 (1.4)
37208-803	Cable Dongle, VGA-USB, Pack of 8	4 (1.8)
37208-603	Cable Dongle, VGA-USB, Pack of 16	7 (3.2)
37208-104	Cable Dongle, VGA-PS/2	3 (1.4)
37208-804	Cable Dongle, VGA-PS/2, Pack of 8	4 (1.8)
37208-604	Cable Dongle, VGA-PS/2, Pack of 16	7 (3.2)
37208-165	Cascade Cable, 6'L (1.8 m)	3 (1.4)

# POWER MANAGEMENT PRODUCTS

Power Strips & Power Distribution Units for Racks and Cabinets

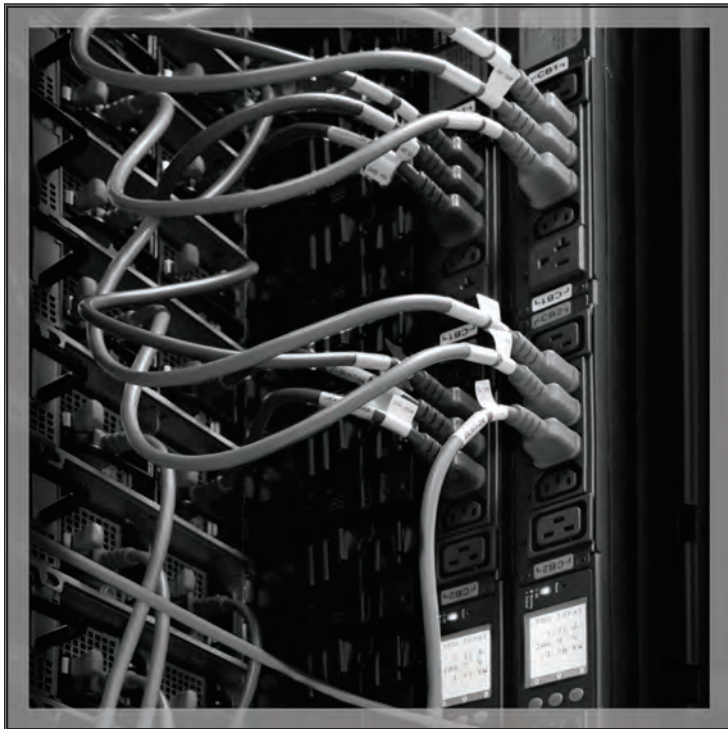

Power Product Options

eConnect® PDUs

Basic eConnect PDU

Monitored eConnect PDU

Monitored Pro eConnect PDU

Switched eConnect PDU

Switched Pro eConnect PDU

Page 7-3

Page 7-5

Page 7-7

Page 7-10

Page 7-13

Page 7-16

Page 7-18

PDUs - Vertical

PDUs - Horizontal, Rack-Mount

Power Strips

Power Strips, International

Power Cords, Accessories

PowerScope In-Line Meter

Uninterruptable Power Supplies

Page 7-20

Page 7-22

Page 7-23

Page 7-25

Page 7-30

Page 7-32

Page 7-33

# POWER MANAGEMENT PRODUCTS

CPI offers an extensive line of power management products that deliver safe and efficient power distribution to critical applications. Ranging from intelligent monitoring and switching capabilities from eConnect® Power Distribution Units (PDUs), to basic Power Strips and In-Line Meters, each of CPI's power management products are specifically designed with flexibility and scalability in mind.

## **CPI Power Management Products feature:**

eConnect® PDUs – Vertical Configurations

- Feature levels: Basic, Monitored, Monitored-Pro, Switched and Switched-Pro
  - Basic: Simple, reliable power distribution when no power monitoring is required
  - Monitored: Includes local current and remote network power monitoring for combined equipment loads
  - Monitored-Pro: Monitored features plus remote power monitoring for each outlet, which measures load for each piece of equipment
  - Switched: Monitored features plus remote control to turn on and off each outlet and cycle power to equipment
  - Switched-Pro: Provides power monitoring and control for each outlet, allowing remote access to measure and cycle power for each piece of equipment attached to PDU
- Single-Phase and Three-Phase plugs
- UL Listed

PDUs

Horizontal rack-mount PDUs for lower density applications, and high amperage vertical-mount PDUs for concentrated cabinet power loads with basic local and remote network current monitoring (Amperes only) capabilities.

Power Strips – Vertical and Horizontal Configurations

Basic, dependable power distribution with optional local monitoring for applications that do not require remote network power monitoring.

- NEMA-IEC and country-specific plug-to-receptacle combinations
- NEMA models are UL Listed

PowerScope In-Line Power Meter

- Upgrade existing basic and metered PDUs with remote network monitoring
- Remote monitoring of current use (Amperes only), temperature and humidity
- Optional local meters; Single- and Dual-Input models; Single- and Three-Phase plugs

Uninterruptable Power Supplies

- 600VA to 10kVA line-interactive and online double conversion UPS from General Electric

## Choose Your Functionality

One of the most crucial steps toward ensuring confidence and uptime for your data center's power management is finding a Power Strip or PDU that best fits your needs. To help you select the best solution for your facility, all CPI Power Management Products are grouped into levels of functionality, as listed below:

Functionality	eConnect® PDU	PDU	Power Strip
Basic	x	x	x
Metered		x	x
Monitored	x	x	
Monitored Pro	x		
Switched	x	x	
Switched Pro	x		





## eConnect PDUs, PDUs and Power Strip Options

Below is a quick comparison across eConnect PDUs, PDUs and CPI Power Strips. Note that all models may not support "included features."

Feature Comparison eConnect® PDUs, PDUs and CPI Power Strips			
Included Feature	eConnect® PDU	PDU	Power Strip
Universal Tool-less Mounting for Cabinets	x	x	x
Low Profile Design	x		
Use in High Temperature Applications - 149°F (65°C) Ready	x		
Branch/Phase Circuit Breakers	x	x	x
Branch/Phase Monitoring (Voltage, Current, Power, Power Factor, Energy)	x	Current Only	Voltage & Current
Local Digital LED Display		Current Only	Voltage & Current
Local Multi-functional LCD Display	x		
Temp/Humidity Sensor Port/Monitoring	x	x	
Second Temp/Humidity Sensor	x		
Network Access for Remote Monitoring (IPv4, IPv6)	x	IPv4 Only	
Network Setup from Local Display	x		
Built-in Web Interface and GUI	x	x	
IP Consolidation (PDU Linking)	x		
Set Alarm Thresholds	x	x	
Forward Alarms as SNMP Traps (v1 / v2 / v3)	x	SMNPv1 Only	
Monitored Outlets (Voltage, Current, Power, Energy)	x		
Email Alarm Notification	x		
Event and Data Logging (Alarms, Metrics, Logins, Setup Changes)	x		
Group Outlets for Remote Current Monitoring	x		
Switched Outlets	x	x	
Cycle Individual Outlets Remotely	x	x	
Cycle Multiple Outlets Simultaneously	x		









## Outlet and Input Plug Table

### Power Receptacles/Outlets





			
NEMA 5-15R 120 VAC/20A	NEMA 5-20R 120 VAC/20A	IEC320 C13 UL: 120/208VAC/15A CE: 208VAC/10A	IEC320 C19 UL: 120/208VAC/20A CE: 208VAC/16A

### Power Plugs:







#### NEMA, Single-Phase and Split-Phase Locking

							
NEMA L5-20P 110-125VAC/20A	NEMA L5-30P 110-125VAC/30A	NEMA L6-20P 200-240VAC/20A	NEMA L6-30P 200-240VAC/30A	NEMA L14-20P 120-240VAC/20A	NEMA L14-30P 120-240VAC/30A	NEMA L5-15P 110-125VAC/15A	NEMA L6-15P 200-240VAC/15A







#### NEMA, Single-Phase/Non-Locking

			
NEMA 5-15P 110-125 VAC/15A	NEMA 5-20P 110-125 VAC/20A	NEMA 6-15P 200-240 VAC/15A	NEMA 6-20P 200-240 VAC/20A

#### NEMA and CS, Three-Phase/Locking

						
NEMA L15-20P 208 VAC/20A	NEMA L15-30P 208 VAC/30A	NEMA L21-20P 120/208 VAC/20A	NEMA L21-30P 120/208 VAC/30A	NEMA L22-20P 380-415 VAC/20A	50A CS8365C 208 VAC/50A*	50A CS8365C 208 VAC/50A*

#### IEC Power Inlet - Universal/Locking

						
IEC C20 110-125 VAC/20A	IEC C20 200-240 VAC/20A	IEC 16A 2P+E 200-240 VAC/16A	IEC 32A 2P+E 200-240 VAC/32A	IEC 60A 3P+E 208VAC/60A	IEC 16A 3P+N+E 230/400 VAC/16A	IEC 32A 3P+N+E 230/400 VAC/32A



Use CPI's online Power Configurator to quickly choose from Power Strips, PDUs or eConnect PDUs with various input/output plug combinations and capabilities. This online tool guides you through each step of identifying the monitoring, switching and outlet needs of your PDU. Visit [www.chatsworth.com/configurator](http://www.chatsworth.com/configurator) for the CPI Product Configurator.



## eConnect PDUs

eConnect PDUs connect you to your evolving enterprise data center with an intelligent power solution that has been engineered to meet the unique thermal challenges of virtually any full-size cabinet or rack configuration. Pushed by consolidation, virtualization and cloud computing, the growing number of kilowatts demanded from each cabinet has intensified the need for a PDU that can withstand increasing heat loads, and maximize efficiency through advanced monitoring. Featuring a low-profile design that reduces airflow disruptions, an ambient air temperature rating of 149°F (65°C) at Input Power Rating (kW) and more than 180 standard configurations, eConnect PDUs are the ultimate connecting point between thermal innovation and intelligent power distribution.

### eConnect PDU Features

- High temperature rating - designed to withstand high ambient air temperatures up to 149°F (65°C) at Input Power Rating (kW) for use in contained spaces and ducted cabinets
- Universal mounting - includes adjustable, tool-less installation hardware that is spaced to match the mounting brackets in most equipment cabinets
- Low-profile design - slender chassis fits in the space behind the equipment mounting rails in equipment cabinet, allowing more space for airflow and cables
- Multi-function display - interactive screen on networked models displays branch power, temperature and humidity measurements, summarizes alarms and allows basic network setup without a computer
- PDU linking (IP consolidation) - connect any combination of up to 20 PDUs together, and access all PDUs through a single IP address using the built-in web interface
- Power monitoring and control - progressive features on select models provide remote power monitoring and switching of individual outlets using the built-in web interface



Universal Mounting - Adjustable, tool-less installation hardware that is spaced to match the mounting brackets in most equipment cabinets.

## Feature Comparison - eConnect® PDUs

Included Feature	Basic	Monitored	Monitored Pro	Switched	Switched Pro
Universal Tool-less Mounting for Cabinets	x	x	x	x	x
Low-Profile Design	x	x	x	x	x
Use in High Temperature Applications 149°F (65°C) Ready at Input Power Rating (kW)	x	x	x	x	x
Branch/Phase Circuit Breakers	x	x	x	x	x
Branch/Phase Monitoring (Voltage, Current, Power, Power Factor, Energy)		x	x	x	x
Local Multi-functional LCD Display (Branch Monitoring, Alarms)		x	x	x	x
Temp/Humidity Sensor Port/Monitoring		x	x	x	x
Second Temp/Humidity Sensor		x	x	x	x
Network Access for Remote Monitoring (IPv4, IPv6)		x	x	x	x
Network Setup from Local Display		x	x	x	x
Built-in Web Interface and GUI		x	x	x	x
IP Consolidation (PDU Linking)		x	x	x	x
Set Alarm Thresholds		x	x	x	x
Forward SNMP Traps (v1 / v2 / v3)		x	x	x	x
Email Alarm Notification		x	x	x	x
Event and Data Logging (Alarms, Metrics, Logins, Setup Changes)		x	x	x	x
Monitored Outlets (Voltage, Current, Power, Energy)			x		x
Group Outlets for Remote Current Monitoring			x		x
Switched Outlets				x	x
Cycle Individual Outlets Remotely				x	x
Cycle Multiple Outlets Simultaneously				x	x
Input Power Configurations					
110-125 VAC, Single-Phase	x	x	x	x	x
110-240 VAC, Single-Phase (includes C20 inlet)	x	x	x	x	x
200-240 VAC, Single-Phase	x	x	x	x	x
120/240 VAC, Split-Phase	x	x			
120/208 VAC, Three-Phase WYE	x	x	x	x	x
208 VAC, Three-Phase DELTA	x	x	x	x	x
380-415 VAC, Three-Phase WYE (200-240 Volt Output)	x	x	x	x	x

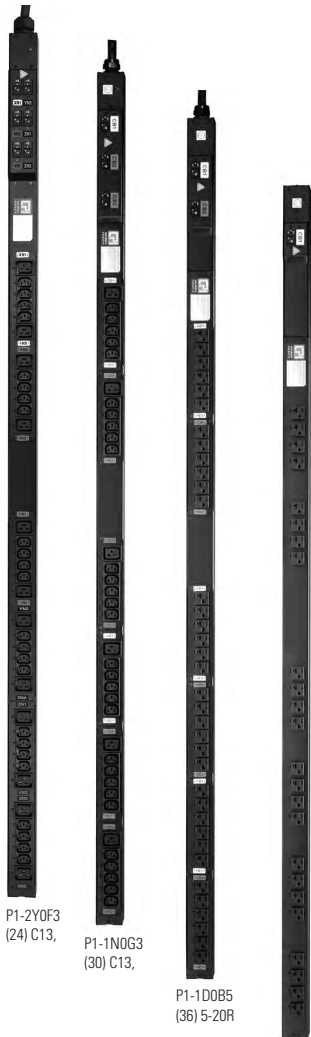

P1-2Y0F3  
(24) C13,

P1-1N0G3  
(30) C13,

P1-1D0B5  
(36) 5-20R

P1-1A1A5  
(24) 5-20R

Features available on the Basic eConnect PDU are available on all eConnect PDUs.

## Basic eConnect PDU

Designed with the universal chassis like all eConnect PDUs, the Basic PDU is a reliable solution for your power distribution needs with tool-less mounting, a low-profile and numerous plug configurations. The Basic PDU is rated for use in ambient air temperatures up to 149°F (65°C) at Input Power Rating (kW), making it ideal for energy-efficient applications, such as Hot Aisle Containment.

- Reliable in high temperature environments up to 149°F (65°C) at input power rating (kW) for confident power delivery in any hot aisle containment environment and full implementation of the newest ASHRAE recommendations
- Universal tool-less mounting fits most cabinets with 64.75" (1645 mm) spacing and alternate 61.25" (1556 mm) spacing
- Low-profile design, 2.2" (56 mm) or 3.2" (81 mm) deep, fits in the zero U space behind the rear mounting rail and does not block exhaust airflow from equipment
- Various combinations of IEC C13, IEC C19 and NEMA 5-20R outlets deliver 208 nominal or 120 nominal VAC to equipment
- Outlets are spaced and grouped for convenience and have snap-on power cord retention tethers to secure C13 and C19 connections
- Low-profile, UL 489 listed, two-pole, hydraulic magnetic breakers resist the effects of high temperatures and limit current to protect equipment
- On multi-breaker PDUs, breaker and outlet groups are color coded for easy identification
- Various IEC and NEMA style plugs for power inputs or IEC C20 inlets that allow site specific power cords

### Specifications:

- Circuit Protection:
  - UL 489 listed, two-pole, hydraulic-magnetic breakers resist effects of high temperatures
  - Low-profile design minimizes size of breaker boxes on PDUs and accidental discharge
- Bonding/Grounding:
  - All PDUs have a grounded power inlet/plug and an external ground connection with a threaded M5 attachment point
  - Includes a grounding kit with a 12"L (300 mm), 12 AWG stranded copper wire jumper
- Certifications:
  - UL
  - CSA C22.2 (Canada)
  - CE (EU)
  - FCC Part 15, Class A
  - EN 55022
  - RoHS Compliant
- Installation Hardware:
  - Includes two tool-less mounting shoulder washers and installation hardware
  - The PDU can be installed with the inlet power cord near the top or bottom of the cabinet
  - Washers can be installed spaced 64.75" (1645 mm) or 61.25" (1556 mm) apart to match most rack/cabinet mounting brackets
- Rack/Cabinet Mounting Brackets:
  - Not included with PDU, order separately
  - Included with most CPI Cabinets, check cabinet specifications



# BASIC eCONNECT PDUs

Part Number	Input			Output		Dims - in (mm)		
	Amp	kW*	Plug	Breakers	Outlets	H	W	D
<b>110-125 Volt, Single-Phase PDUs</b>								
P1-1A1A5	20	1.9	IEC C20**	1 x 2P 20A	(24) 5-20R	70.5 (1791)	2.2 (56)	2.2 (56)
P1-1C0A5	20	1.9	NEMA L5-20P	1 x 2P 20A	(24) 5-20R	70.5 (1791)	2.2 (56)	2.2 (56)
P1-1D0A5	30	2.9	NEMA L5-30P	2 x 2P 20A	(24) 5-20R	70.5 (1791)	2.2 (56)	2.2 (56)
P1-1D0B5	30	2.9	NEMA L5-30P	2 x 2P 20A	(36) 5-20R	70.5 (1791)	2.2 (56)	2.2 (56)
<b>110-125 or 200-240 Volt, Single-Phase PDUs</b>								
P1-1A1E3	20	1.9 or 3.3	IEC C20**	1 x 2P 20A	(24) C13, (6) C19	70.5 (1791)	2.2 (56)	2.2 (56)
<b>200-240 Volt, Single-Phase PDUs</b>								
P1-1E0E3	20	3.3	NEMA L6-20P	1 x 2P 20A	(24) C13, (6) C19	70.5 (1791)	2.2 (56)	2.2 (56)
P1-1F0B1	30	5.0	NEMA L6-30P	2 x 2P 20A	(36) C13	70.5 (1791)	2.2 (56)	2.2 (56)
P1-1F0E3	30	5.0	NEMA L6-30P	2 x 2P 20A	(24) C13, (6) C19	70.5 (1791)	2.2 (56)	2.2 (56)
P1-1F0G3	30	5.0	NEMA L6-30P	2 x 2P 20A	(30) C13, (6) C19	70.5 (1791)	2.2 (56)	2.2 (56)
P1-1G0E3	16	2.7	IEC 16A 2P+E	1 x 2P 16A	(24) C13, (6) C19	70.5 (1791)	2.2 (56)	2.2 (56)
P1-1H0B1	32	5.3	IEC 32A 2P+E	2 x 2P 16A	(36) C13	70.5 (1791)	2.2 (56)	2.2 (56)
P1-1H0E3	32	5.3	IEC 32A 2P+E	2 x 2P 16A	(24) C13, (6) C19	70.5 (1791)	2.2 (56)	2.2 (56)
P1-1H0G3	32	5.3	IEC 32A 2P+E	2 x 2P 16A	(30) C13, (6) C19	70.5 (1791)	2.2 (56)	2.2 (56)
<b>120/240 Volt, Split-Phase PDUs (240 Volt Output on C13/C19)</b>								
P1-1J0K4	20	3.3	NEMA L14-20P	1 x 2P 20A	(24) C13, (6) C19, (6) 5-20R	70.5 (1791)	2.2 (56)	2.2 (56)
P1-1K0K4	30	5.0	NEMA L14-30P	2 x 2P 20A	(24) C13, (6) C19, (6) 5-20R	70.5 (1791)	2.2 (56)	2.2 (56)
<b>120/208 Volt, Three-Phase WYE PDUs (208 Volt Output on C13/C19)</b>								
P1-1N0B5	20	5.8	NEMA L21-20P	3 x 2P 20A	(36) 5-20R	70.5 (1791)	2.2 (56)	2.2 (56)
P1-1N0K4	20	5.8	NEMA L21-20P	3 x 2P 20A	(24) C13, (6) C19, (6) 5-20R	70.5 (1791)	2.2 (56)	2.2 (56)
P1-1N0L4	20	5.8	NEMA L21-20P	3 x 2P 20A	(24) C13, (9) C19, (3) 5-20R	70.5 (1791)	2.2 (56)	2.2 (56)
P1-1P0B5	30	8.6	NEMA L21-30P	3 x 2P 20A	(36) 5-20R	70.5 (1791)	2.2 (56)	2.2 (56)
P1-1P0K4	30	8.6	NEMA L21-30P	3 x 2P 20A	(24) C13, (6) C19, (6) 5-20R	70.5 (1791)	2.2 (56)	2.2 (56)
P1-1P0L4	30	8.6	NEMA L21-30P	3 x 2P 20A	(24) C13, (9) C19, (3) 5-20R	70.5 (1791)	2.2 (56)	2.2 (56)
<b>208 Volt, Three-Phase DELTA PDUs (208 Volt Output)</b>								
P1-1L0B1	20	5.8	NEMA L15-20P	3 x 2P 20A	(36) C13	70.5 (1791)	2.2 (56)	2.2 (56)
P1-1L0G3	20	5.8	NEMA L15-20P	3 x 2P 20A	(30) C13, (6) C19	70.5 (1791)	2.2 (56)	2.2 (56)
P1-1N0B1	20	5.8	NEMA L21-20P	3 x 2P 20A	(36) C13	70.5 (1791)	2.2 (56)	2.2 (56)
P1-1N0G3	20	5.8	NEMA L21-20P	3 x 2P 20A	(30) C13, (6) C19	70.5 (1791)	2.2 (56)	2.2 (56)
P1-1M0B1	30	8.6	NEMA L15-30P	3 x 2P 20A	(36) C13	70.5 (1791)	2.2 (56)	2.2 (56)
P1-1M0G3	30	8.6	NEMA L15-30P	3 x 2P 20A	(30) C13, (6) C19	70.5 (1791)	2.2 (56)	2.2 (56)
P1-1P0B1	30	8.6	NEMA L21-30P	3 x 2P 20A	(36) C13	70.5 (1791)	2.2 (56)	2.2 (56)
P1-1P0G3	30	8.6	NEMA L21-30P	3 x 2P 20A	(30) C13, (6) C19	70.5 (1791)	2.2 (56)	2.2 (56)
P1-1T0B1	50	12.6	50A CS8365C	3 x 2P 20A	(36) C13	70.5 (1791)	2.2 (56)	2.2 (56)
P1-1T0F3	50	12.6	50A CS8365C	3 x 2P 20A	(24) C13, (12) C19	70.5 (1791)	2.2 (56)	2.2 (56)
P1-1T0G3	50	12.6	50A CS8365C	3 x 2P 20A	(30) C13, (6) C19	70.5 (1791)	2.2 (56)	2.2 (56)

Part Number	Input			Output		Dims - in (mm)		
	Amp	kW*	Plug	Breakers	Outlets	H	W	D
<b>380-415 Volt, Three-Phase WYE PDUs (200-240 Volt Output)</b>								
P1-1Q0B1	20	11.1	NEMA L22-20P	3 x 2P 20A	(36) C13	70.5 (1791)	2.2 (56)	2.2 (56)
P1-1Q0G3	20	11.1	NEMA L22-20P	3 x 2P 20A	(30) C13, (6) C19	70.5 (1791)	2.2 (56)	2.2 (56)
P1-2R0F3	30	16.6	NEMA L22-30P	6 X 1P 20A	(24) C13, (12) C19	72.0 (1829)	2.4 (61)	2.2 (56)
P1-2R0H3	30	16.6	NEMA L22-30P	6 X 1P 20A	(36) C13, (6) C19	72.0 (1829)	2.4 (61)	2.2 (56)
P1-1W0B1	16	8.9	IEC 16A 3P+N+E	3 x 2P 16A	(36) C13	70.5 (1791)	2.2 (56)	2.2 (56)
P1-1W0G3	16	8.9	IEC 16A 3P+N+E	3 x 2P 16A	(30) C13, (6) C19	70.5 (1791)	2.2 (56)	2.2 (56)
P1-2Y0F3	32	17.7	IEC 32A 3P+N+E	6 X 1P 20A	(24) C13, (12) C19	72.0 (1829)	2.4 (61)	2.2 (56)
P1-2Y0H3	32	17.7	IEC 32A 3P+N+E	6 x 1P 20A	(36) C13, (6) C19	72.0 (1829)	2.4 (61)	2.2 (56)

Ordering Notes: Order mounting brackets separately. PDUs that are 75"H (1905 mm) must be placed in 44U or taller cabinets.  
 On Single-Phase PDUs, output voltage equals input voltage. On Split- and Three-Phase PDUs, 208 VAC nominal output through C13 and C19 outlets; 120 VAC nominal output through NEMA 5-20R outlets.  
 \* For kW column, all values are derated calculations per UL for use in North America. For 50A PDUs, the 50A CS8365C plug is rated for 50A, but maximum input is 35A (12.6 kw) on three breaker PDUs.  
 \*\* Order power cord separately for PDU with C20 input.

**Dimensional Drawing:**

(P1-1A1E3 shown)

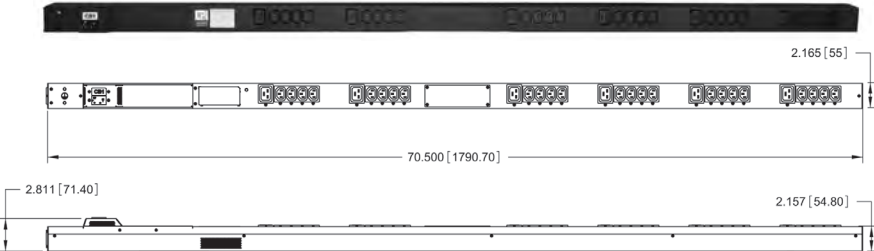

(P1-2Y0F3 shown)

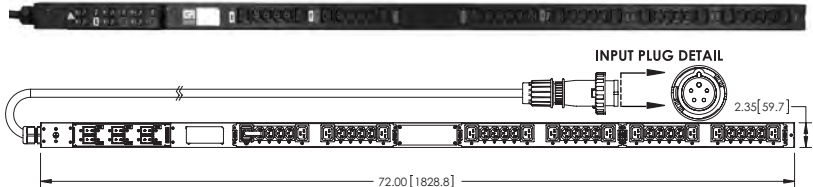

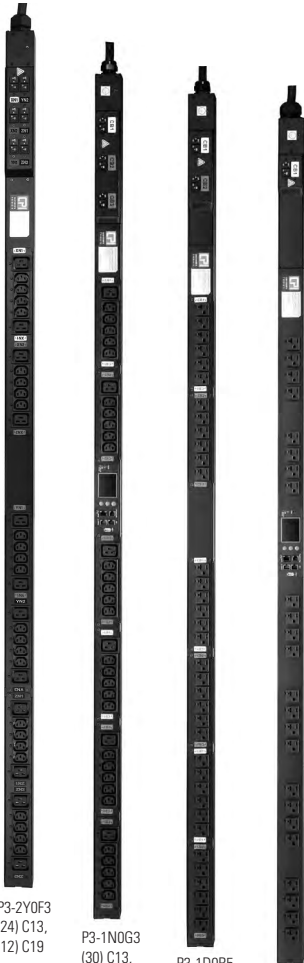

P3-2Y0F3  
(24) C13,  
(12) C19

P3-1N0G3  
(30) C13,  
(6) C19

P3-1D0B5  
(36) 5-20R

P3-1C0A5  
(24) 5-20R

**Monitored eConnect PDUs include all the features available on Basic PDUs, including a low-profile chassis and an ambient temperature rating up to 149°F (65°C) at Input Power Rating (kW).**

## Monitored eConnect PDU

View a snapshot of your equipment rack's overall power usage with CPI's Monitored eConnect PDU. Accessible locally by a LCD screen or remotely over an IP connection, data center managers can view individual PDUs or link them together and use the built-in web interface to determine which cabinets and racks are the biggest strain on their daily IT power budget.

- Continuous voltage, current, power, power factor and energy monitoring for each branch or phase (breaker) on the unit
- Supplies  $\pm 1\%$  accuracy power measurement
- Includes an external connection for two probes with temperature and humidity sensors for monitoring environmental conditions in your cabinet
- Easy-to-read central display provides detailed information about total power usage, alarms and environmental conditions when sensors are attached
- Quick and easy network setup of the IP address and subnet mask using the local display attaches PDU directly to your network
- Access the PDU remotely using a web browser for detailed measurements and power totals and to set upper and lower threshold alarms for power, temperature and humidity
- PDU linking feature allows you to connect up to 20 PDUs together, and access all of the PDUs using a single IP connection and one IP address
- The web browser lets you easily click between linked PDUs, and any alarms are indicated by color coding and summarized on a separate tab
- Forward email alarm notifications, log data and events to keep a record of power use and alarms
- Ability to monitor the PDU with a third-party software that accepts SNMP traps or through a direct serial connection

### Specifications:

- Network/External Connections:
  - (1) 10/100 Mbps RJ-45 Ethernet connection (IPv4 and IPv6)
  - (1) RJ11 Environmental Probe connection
  - (1) RJ45 Serial/PDU In linking connection (RS-232)
  - (1) RJ45 PDU Out linking connection
  - (1) USB port for firmware updates
- Internal Metering:
  - Monitors unit voltage, current, power (kW), power factor and energy (kWh) at each breaker; with  $\pm 1\%$  metering accuracy at each breaker
- Local Display:
  - Liquid Crystal Display (LCD) for easy viewing; allows initial setup of IP and subnet addresses without computer
  - Displays total voltage, current and power for attached equipment and alarm notifications; displays line input current on three-phase units
- Network Monitoring:
  - Monitor total voltage, current, power, power factor and energy through the Ethernet using a web browser (HTTP and HTTPS), SSH2 or Telnet, or an application that accepts alarms as SNMP v1, v2c or v3 traps
  - Monitor temperature and humidity when external environmental probe is attached to the PDU, set and automatically monitor high and low alarm thresholds for power, temperature and humidity
  - Log data and events and receive alarm notifications by email
- IP Consolidation (PDU Linking):
  - Use the PDU In/Out connections to link up to 20 PDUs together using standard RJ45 Cat 5/6 patch cords
  - View all connected PDUs through a single network connection and IP address

Part Number	Input			Output		Dims - in (mm)		
	Amp	kW*	Plug	Breakers	Outlets	H	W	D
<b>110-125 Volt, Single-Phase PDUs</b>								
P3-1A1A5	20	1.9	IEC C20**	1 x 2P 20A	(24) 5-20R	70.5 (1791)	2.2 (56)	2.2 (56)
P3-1A1B5	20	1.9	IEC C20**	1 x 2P 20A	(36) 5-20R	70.5 (1791)	2.2 (56)	2.2 (56)
P3-1COA5	20	1.9	NEMA L5-20P	1 x 2P 20A	(24) 5-20R	70.5 (1791)	2.2 (56)	2.2 (56)
P3-1COB5	20	1.9	NEMA L5-20P	1 x 2P 20A	(36) 5-20R	70.5 (1791)	2.2 (56)	2.2 (56)
P3-1DOA5	30	2.9	NEMA L5-30P	2 x 2P 20A	(24) 5-20R	70.5 (1791)	2.2 (56)	2.2 (56)
P3-1DOB5	30	2.9	NEMA L5-30P	2 x 2P 20A	(36) 5-20R	70.5 (1791)	2.2 (56)	2.2 (56)
<b>110-125 or 200-240 Volt, Single-Phase PDUs</b>								
P3-1A1E3	20	1.9 or 3.3	IEC C20**	1 x 2P 20A	(24) C13, (6) C19	70.5 (1791)	2.2 (56)	2.2 (56)
<b>200-240 Volt, Single-Phase PDUs</b>								
P3-1E0E3	20	3.3	NEMA L6-20P	1 x 2P 20A	(24) C13, (6) C19	70.5 (1791)	2.2 (56)	2.2 (56)
P3-1F0B1	30	5.0	NEMA L6-30P	2 x 2P 20A	(36) C13	70.5 (1791)	2.2 (56)	2.2 (56)
P3-1F0E3	30	5.0	NEMA L6-30P	2 x 2P 20A	(24) C13, (6) C19	70.5 (1791)	2.2 (56)	2.2 (56)
P3-1F0G3	30	5.0	NEMA L6-30P	2 x 2P 20A	(30) C13, (6) C19	70.5 (1791)	2.2 (56)	2.2 (56)
P3-1G0E3	16	2.7	IEC 16A 2P+E	1 x 2P 16A	(24) C13, (6) C19	70.5 (1791)	2.2 (56)	2.2 (56)
P3-1H0B1	32	5.3	IEC 32A 2P+E	2 x 2P 16A	(36) C13	70.5 (1791)	2.2 (56)	2.2 (56)
P3-1H0E3	32	5.3	IEC 32A 2P+E	2 x 2P 16A	(24) C13, (6) C19	70.5 (1791)	2.2 (56)	2.2 (56)
P3-1H0G3	32	5.3	IEC 32A 2P+E	2 x 2P 16A	(30) C13, (6) C19	70.5 (1791)	2.2 (56)	2.2 (56)
<b>120/240 Volt, Split-Phase PDUs (240 Volt Output on C13/C19)</b>								
P3-1J0K4	20	3.3	NEMA L14-20P	1 x 2P 20A	(24) C13, (6) C19, (6) 5-20R	70.5 (1791)	2.2 (56)	2.2 (56)
P3-1K0K4	30	5.0	NEMA L14-30P	2 x 2P 20A	(24) C13, (6) C19, (6) 5-20R	70.5 (1791)	2.2 (56)	2.2 (56)
<b>120/208 Volt, Three-Phase WYE PDUs (208 Volt Output on C13/C19)</b>								
P3-1N0K4	20	5.8	NEMA L21-20P	3 x 2P 20A	(24) C13, (6) C19, (6) 5-20R	70.5 (1791)	2.2 (56)	2.2 (56)
P3-1N0L4	20	5.8	NEMA L21-20P	3 x 2P 20A	(24) C13, (9) C19, (3) 5-20R	70.5 (1791)	2.2 (56)	2.2 (56)
P3-1N0B5	20	5.8	NEMA L21-20P	3 x 2P 20A	(36) 5-20R	70.5 (1791)	2.2 (56)	2.2 (56)
P3-1P0K4	30	8.6	NEMA L21-30P	3 x 2P 20A	(24) C13, (6) C19, (6) 5-20R	70.5 (1791)	2.2 (56)	2.2 (56)
P3-1P0L4	30	8.6	NEMA L21-30P	3 x 2P 20A	(24) C13, (9) C19, (3) 5-20R	70.5 (1791)	2.2 (56)	2.2 (56)
P3-1P0B5	30	8.6	NEMA L21-30P	3 x 2P 20A	(36) 5-20R	70.5 (1791)	2.2 (56)	2.2 (56)
<b>208 Volt, Three-Phase DELTA PDUs (208 Volt Output)</b>								
P3-1L0B1	20	5.8	NEMA L15-20P	3 x 2P 20A	(36) C13	70.5 (1791)	2.2 (56)	2.2 (56)
P3-1L0G3	20	5.8	NEMA L15-20P	3 x 2P 20A	(30) C13, (6) C19	70.5 (1791)	2.2 (56)	2.2 (56)
P3-1N0B1	20	5.8	NEMA L21-20P	3 x 2P 20A	(36) C13	70.5 (1791)	2.2 (56)	2.2 (56)
P3-1N0G3	20	5.8	NEMA L21-20P	3 x 2P 20A	(30) C13, (6) C19	70.5 (1791)	2.2 (56)	2.2 (56)
P3-1M0B1	30	8.6	NEMA L15-30P	3 x 2P 20A	(36) C13	70.5 (1791)	2.2 (56)	2.2 (56)
P3-1M0F3	30	8.6	NEMA L15-30P	3 x 2P 20A	(24) C13, (12) C19	70.5 (1791)	2.2 (56)	2.2 (56)
P3-1M0G3	30	8.6	NEMA L15-30P	3 x 2P 20A	(30) C13, (6) C19	70.5 (1791)	2.2 (56)	2.2 (56)
P3-1P0B1	30	8.6	NEMA L21-30P	3 x 2P 20A	(36) C13	70.5 (1791)	2.2 (56)	2.2 (56)
P3-1P0F3	30	8.6	NEMA L21-30P	3 x 2P 20A	(24) C13, (12) C19	70.5 (1791)	2.2 (56)	2.2 (56)
P3-1P0G3	30	8.6	NEMA L21-30P	3 x 2P 20A	(30) C13, (6) C19	70.5 (1791)	2.2 (56)	2.2 (56)
P3-1T0B1	50	12.6	50A CS8365C	3 x 2P 20A	(36) C13	70.5 (1791)	2.2 (56)	2.2 (56)
P3-1T0F3	50	12.6	50A CS8365C	3 x 2P 20A	(24) C13, (12) C19	70.5 (1791)	2.2 (56)	2.2 (56)

# MONITORED eCONNECT PDUs

Part Number	Input			Output		Dims - in (mm)		
	Amp	kW*	Plug	Breakers	Outlets	H	W	D
<b>208 Volt, Three-Phase DELTA PDUs (208 Volt Output)</b>								
P3-1T0G3	50	12.6	50A CS8365C	3 x 2P 20A	(30) C13, (6) C19	70.5 (1791)	2.2 (56)	2.2 (56)
P3-3U0H3	50	14.4	50A CS8365C	6 x 2P 20A	(36) C13, (6) C19	75.0 (1905)	2.7 (69)	2.2 (56)
P3-3U0V3	50	14.4	50A CS8365C	6 x 2P 20A	(12) C13, (18) C19	75.0 (1905)	2.7 (69)	2.2 (56)
P3-3V0H3	60	17.3	IEC 60A 3P+E	6 x 2P 20A	(36) C13, (6) C19	75.0 (1905)	2.7 (69)	2.2 (56)
P3-3V0V3	60	17.3	IEC 60A 3P+E	6 x 2P 20A	(12) C13, (18) C19	75.0 (1905)	2.7 (69)	2.2 (56)
<b>380-415 Volt, Three-Phase WYE PDUs (200-240 Volt Output)</b>								
P3-1Q0B1	20	11.1	NEMA L22-20P	3 x 2P 20A	(36) C13	70.5 (1791)	2.2 (56)	2.2 (56)
P3-1Q0F3	20	11.1	NEMA L22-20P	3 X 2P 20A	(24) C13, (12) C19	70.5 (1791)	2.2 (56)	2.2 (56)
P3-1Q0G3	20	11.1	NEMA L22-20P	3 x 2P 20A	(30) C13, (6) C19	70.5 (1791)	2.2 (56)	2.2 (56)
P3-2R0F3	30	16.6	NEMA L22-30P	6 x 1P 20A	(24) C13, (12) C19	72.0 (1829)	2.4 (61)	2.2 (56)
P3-2R0H3	30	16.6	NEMA L22-30P	6 x 1P 20A	(36) C13, (6) C19	72.0 (1829)	2.4 (61)	2.2 (56)
P3-1W0B1	16	8.9	IEC 16A 3P+N+E	3 x 2P 16A	(36) C13	70.5 (1791)	2.2 (56)	2.2 (56)
P3-1W0F3	16	8.9	IEC 16A 3P+N+E	3 X 2P 16A	(24) C13, (12) C19	70.5 (1791)	2.2 (56)	2.2 (56)
P3-1W0G3	16	8.9	IEC 16A 3P+N+E	3 x 2P 16A	(30) C13, (6) C19	70.5 (1791)	2.2 (56)	2.2 (56)
P3-2Y0F3	32	17.7	IEC 32A 3P+N+E	6 x 1P 20A	(24) C13, (12) C19	72.0 (1829)	2.4 (61)	2.2 (56)
P3-2Y0H3	32	17.7	IEC 32A 3P+N+E	6 x 1P 20A	(36) C13, (6) C19	72.0 (1829)	2.4 (61)	2.2 (56)

*Ordering Notes: Order mounting brackets separately. PDUs that are 75"H (1905 mm) must be placed in 45U or taller cabinets.*  
*On Single-Phase PDUs, output voltage equals input voltage. On Split- and Three-Phase PDUs, 208 VAC nominal output through C13 and C19 outlets; 120 VAC nominal output through NEMA 5-20R outlets.*  
*\* For kW column, all values are derated calculations per UL for use in North America. For 50A PDUs, the 50A CS8365C plug is rated for 50A, but maximum input is 35A (12.6 kw) on three breaker PDUs.*  
*\*\* Order power cord separately for PDU with C20 input.*

## Dimensional Drawing:

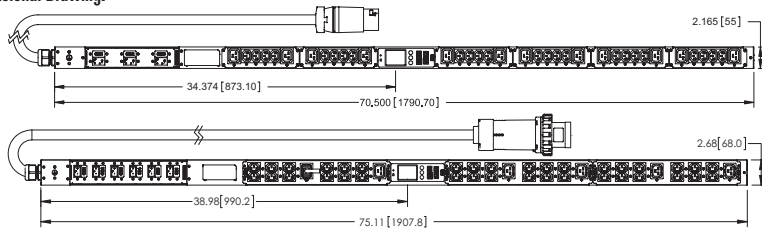

Easy-to-read, LCD display screen



Remote Network Monitoring - ability to monitor the PDU with a web browser

## Monitored Pro eConnect PDU

To manage how much power your equipment uses on a daily basis, you must first have a reliable way of measuring the usage. The Monitored Pro eConnect PDU monitors power use through each outlet and is ideal for colocation facilities that monitor power consumption or data center managers searching for efficiencies on individual pieces of equipment. Monitored Pro eConnect PDUs also allow remote and IP access to monitoring features for outlet grouping and naming across one or multiple PDUs for a mix of equipment assigned to different users or customers.

- Continuous voltage, current, power and energy monitoring for each outlet on the unit that can be remotely monitored using a web browser
- Outlets are numbered for easy identification
- Name outlets to more easily associate outlets with equipment
- Group outlets to see total current use for several pieces of connected equipment
- Set alarms for upper and lower current thresholds for each outlet

### Specifications:

- Circuit Protection:
  - UL 489 listed, two-pole, hydraulic-magnetic breakers to resist effects of high temperatures
  - Low-profile design minimizes size of breaker
- Network/External Connections:
  - (1) 10/100 Mbps RJ-45 Ethernet connection (IPv4 and IPv6)
  - (1) RJ11 Environmental Probe connection
  - (1) RJ45 Serial/PDU In linking connection (RS-232)
  - (1) RJ45 PDU Out linking connection
  - (1) USB port for firmware updates
- Internal Metering:
  - Monitors unit voltage, current, power (kW), power factor and energy (kWh) at each breaker; with  $\pm 1\%$  metering accuracy at each breaker
- Local Display:
  - Liquid Crystal Display (LCD) for easy viewing; allows initial setup of IP and subnet addresses without computer
  - Displays total voltage, current and power for attached equipment; displays line input current on three-phase units; displays temperature and humidity when options environmental probe (P/N 11761-003) is attached to PDU
- Network Monitoring:
  - Monitor total voltage, current, power, power factor and energy through the Ethernet using a web browser (HTTP and HTTPS), SSH2 or Telnet or an application that accepts alarms as SNMP v1, v2c or v3 traps
  - Monitor temperature and humidity when external environmental probe is attached to the PDU, set and automatically monitor high and low alarm thresholds for power, temperature and humidity
  - Log data and events and receive alarm notifications by email
- IP Consolidation (PDU Linking):
  - Use the PDU In/Out connections to link up to 20 PDUs together using standard RJ45 Cat 5/6 patch cords
  - View all connected PDUs through a single network connection and IP address
- Monitored Outlets:
  - Remotely monitor voltage, current, and power (kW) and energy (kWh) at each outlet
  - Name outlets to easily identify attached equipment
  - Create outlet groups to see combined power use

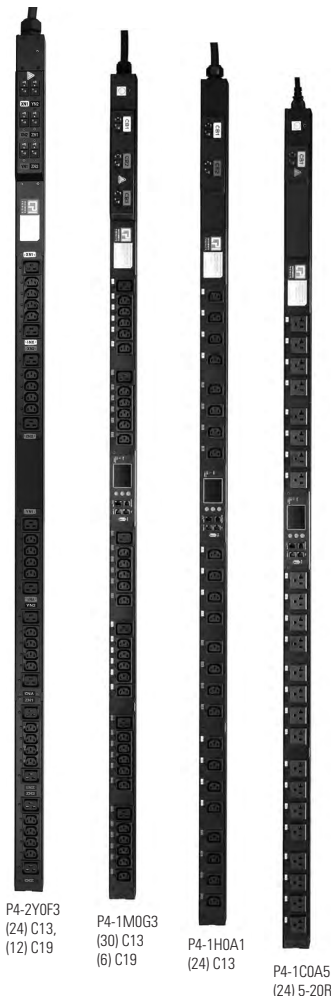

**Monitored Pro eConnect PDUs include all the features available on Monitored and Basic PDUs — local and remote total power usage monitoring, a low-profile chassis and an ambient temperature rating up to 149°F (65°C) at Input Power Rating (kW).**

# MONITORED PRO eCONNECT PDUs

Part Number	Input			Output		Dims - in (mm)		
	Amp	kW*	Plug	Breakers	Outlets	H	W	D
<b>110-125 Volt, Single-Phase PDUs</b>								
P4-1A1A5	20	1.9	IEC C20**	1 x 2P 20A	(24) 5-20R	70.5 (1791)	2.2 (56)	2.2 (56)
P4-1C0A5	20	1.9	NEMA L5-20P	1 x 2P 20A	(24) 5-20R	70.5 (1791)	2.2 (56)	2.2 (56)
P4-1D0A5	30	2.9	NEMA L5-30P	2 x 2P 20A	(24) 5-20R	70.5 (1791)	2.2 (56)	2.2 (56)
<b>110-125 or 200-240 Volt, Single-Phase PDUs</b>								
P4-1A1A1	20	1.9 or 3.3	IEC C20**	1 x 2P 20A	(24) C13	70.5 (1791)	2.2 (56)	2.2 (56)
P4-1A1C3	20	1.9 or 3.3	IEC C20**	1 x 2P 20A	(18) C13, (6) C19	70.5 (1791)	2.2 (56)	2.2 (56)
<b>200-240 Volt, Single-Phase PDUs</b>								
P4-1E0A1	20	3.3	NEMA L6-20P	1 x 2P 20A	(24) C13	70.5 (1791)	2.2 (56)	2.2 (56)
P4-1E0C3	20	3.3	NEMA L6-20P	1 x 2P 20A	(18) C13, (6) C19	70.5 (1791)	2.2 (56)	2.2 (56)
P4-1F0A1	30	5.0	NEMA L6-30P	2 x 2P 20A	(24) C13	70.5 (1791)	2.2 (56)	2.2 (56)
P4-1F0B1	30	5.0	NEMA L6-30P	2 x 2P 20A	(36) C13	70.5 (1791)	2.2 (56)	2.2 (56)
P4-1F0C3	30	5.0	NEMA L6-30P	2 x 2P 20A	(18) C13, (6) C19	70.5 (1791)	2.2 (56)	2.2 (56)
P4-1F0G3	30	5.0	NEMA L6-30P	2 x 2P 20A	(30) C13, (6) C19	70.5 (1791)	2.2 (56)	2.2 (56)
P4-1G0A1	16	2.7	IEC 16A 2P+E	1 x 2P 16A	24 (C13)	70.5 (1791)	2.2 (56)	2.2 (56)
P4-1G0C3	16	2.7	IEC 16A 2P+E	1 x 2P 16A	(18) C13, (6) C19	70.5 (1791)	2.2 (56)	2.2 (56)
P4-1H0A1	32	5.3	IEC 32A 2P+E	2 x 2P 16A	(24) C13	70.5 (1791)	2.2 (56)	2.2 (56)
P4-1H0B1	32	5.3	IEC 32A 2P+E	2 x 2P 16A	(36) C13	70.5 (1791)	2.2 (56)	2.2 (56)
P4-1H0C3	32	5.3	IEC 32A 2P+E	2 x 2P 16A	(18) C13, (6) C19	70.5 (1791)	2.2 (56)	2.2 (56)
P4-1H0G3	32	5.3	IEC 32A 2P+E	2 x 2P 16A	(30) C13, (6) C19	70.5 (1791)	2.2 (56)	2.2 (56)
<b>120/208 Volt, Three-Phase WYE PDUs (120 Volt Output)</b>								
P4-1N0A5	20	5.8	NEMA L21-20P	3 x 2P 20A	(24) 5-20R	70.5 (1791)	2.2 (56)	2.2 (56)
P4-1P0A5	30	8.6	NEMA L21-30P	3 x 2P 20A	(24) 5-20R	70.5 (1791)	2.2 (56)	2.2 (56)
<b>208 Volt, Three-Phase DELTA PDUs (208 Volt Output)</b>								
P4-1L0B1	20	5.8	NEMA L15-20P	3 x 2P 20A	(36) C13	70.5 (1791)	2.2 (56)	2.2 (56)
P4-1L0G3	20	5.8	NEMA L15-20P	3 x 2P 20A	(30) C13, (6) C19	70.5 (1791)	2.2 (56)	2.2 (56)
P4-1N0B1	20	5.8	NEMA L21-20P	3 x 2P 20A	36 (C13)	70.5 (1791)	2.2 (56)	2.2 (56)
P4-1N0G3	20	5.8	NEMA L21-20P	3 x 2P 20A	(30) C13, (6) C19	70.5 (1791)	2.2 (56)	2.2 (56)
P4-1M0B1	30	8.6	NEMA L15-30P	3 x 2P 20A	(36) C13	70.5 (1791)	2.2 (56)	2.2 (56)
P4-1M0F3	30	8.6	NEMA L15-30P	3 x 2P 20A	(24) C13, (12) C19	70.5 (1791)	2.2 (56)	2.2 (56)
P4-1M0G3	30	8.6	NEMA L15-30P	3 x 2P 20A	(30) C13, (6) C19	70.5 (1791)	2.2 (56)	2.2 (56)
P4-1P0B1	30	8.6	NEMA L21-30P	3 x 2P 20A	(36) C13	70.5 (1791)	2.2 (56)	2.2 (56)
P4-1P0F3	30	8.6	NEMA L21-30P	3 x 2P 20A	(24) C13, (12) C19	70.5 (1791)	2.2 (56)	2.2 (56)
P4-1P0G3	30	8.6	NEMA L21-30P	3 x 2P 20A	(30) C13, (6) C19	70.5 (1791)	2.2 (56)	2.2 (56)
P4-1T0B1	50	12.6	50A CS8365C	3 x 2P 20A	(36) C13	70.5 (1791)	2.2 (56)	2.2 (56)
P4-1T0F3	50	12.6	50A CS8365C	3 x 2P 20A	(24) C13, (12) C19	70.5 (1791)	2.2 (56)	2.2 (56)
P4-3U0H3	50	14.4	50A CS8365C	6 X 2P 20A	(36) C13, (6) C19	75.0 (1905)	2.7 (69)	2.2 (56)
P4-3U0V3	50	14.4	50A CS8365C	6 X 2P 20A	(12) C13, (18) C19	75.0 (1905)	2.7 (69)	2.2 (56)
P4-3V0H3	60	17.3	IEC 60A 3P+E	6 X 2P 20A	(36) C13, (6) C19	75.0 (1905)	2.7 (69)	2.2 (56)
P4-3V0V3	60	17.3	IEC 60A 3P+E	6 X 2P 20A	(12) C13, (18) C19	75.0 (1905)	2.7 (69)	2.2 (56)

Part Number	Input			Output		Dims - in (mm)		
	Amp	kW*	Plug	Breakers	Outlets	H	W	D
<b>380-415 Volt, Three-Phase WYE PDUs (200-240 Volt Output)</b>								
P4-1Q0B1	20	11.1	NEMA L22-20P	3 x 2P 20A	(36) C13	70.5 (1791)	2.2 (56)	2.2 (56)
P4-1Q0G3	20	11.1	NEMA L22-20P	3 x 2P 20A	(30) C13, (6) C19	70.5 (1791)	2.2 (56)	2.2 (56)
P4-2R0F3	30	16.6	NEMA L22-30P	6 x 1P 20A	(24) C13, (12) C19	72.0 (1829)	2.4 (61)	2.2 (56)
P4-2R0H3	30	16.6	NEMA L22-30P	6 x 1P 20A	(36) C13 x (6) C19	72.0 (1829)	2.4 (61)	2.2 (56)
P4-1W0B1	16	8.9	IEC 16A 3P+N+E	3 x 2P 16A	(36) C13	70.5 (1791)	2.2 (56)	2.2 (56)
P4-1W0G3	16	8.9	IEC 16A 3P+N+E	3 x 2P 16A	(30) C13, (6) C19	70.5 (1791)	2.2 (56)	2.2 (56)
P4-2Y0F3	32	17.7	IEC 32A 3P+N+E	6 x 1P 20A	(24) C13, (12) C19	72.0 (1829)	2.4 (61)	2.2 (56)
P4-2Y0H3	32	17.7	IEC 32A 3P+N+E	6 x 1P x20A	(36) C13, (6) C19	72.0 (1829)	2.4 (61)	2.2 (56)

Ordering Notes: Order mounting brackets separately. PDUs that are 75"H (1905 mm) must be placed in 45U or taller cabinets. On Single-Phase PDUs, output voltage equals input voltage. On Split- and Three-Phase PDUs, 208 VAC nominal output through C13 and C19 outlets; 120 VAC nominal output through NEMA 5-20R outlets.

\* For kW column, all values are derated calculations per UL for use in North America. For 50A PDUs, the 50A CS8365C plug is rated for 50A, but maximum input is 35A (12.6 kw) on three breaker PDUs.

\*\* Order power cord separately for PDU with C20 input.

## Dimensional Drawing:

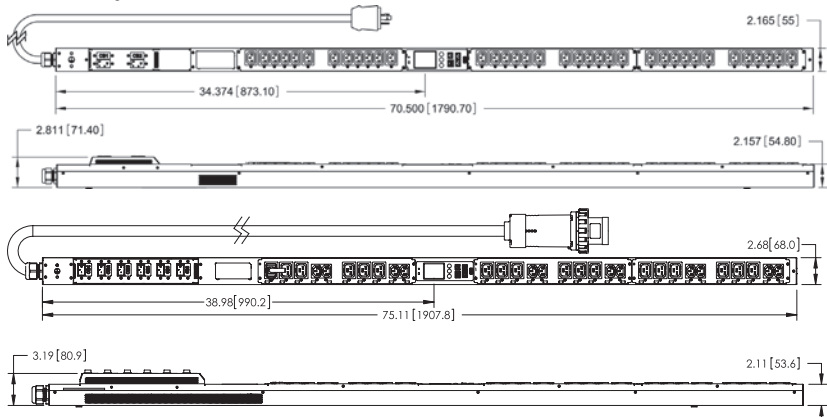

Individually Numbered



Outlet Set-Up - Ability to set alarms for upper and lower current thresholds for each outlet.



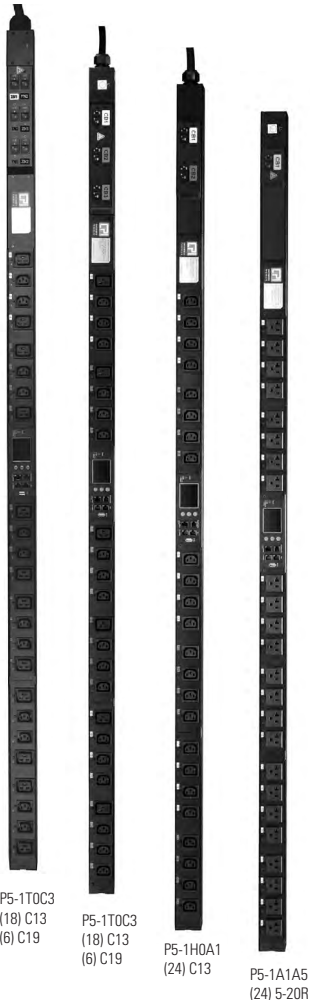

Switched eConnect PDUs include all the features available on Monitored and Basic PDUs, including local and remote total power usage monitoring, a low-profile chassis and an ambient temperature rating up to 149°F (65°C) at Input Power Rating (kW).

## Switched eConnect PDU

Switched eConnect PDUs are the ideal blend of design, overall power monitoring and individual switching capabilities. Choose a Switched eConnect PDU when you need to remotely control power use and resolve issues with frozen equipment by cycling the power on individual outlets. Equipped with linking capabilities for up to 20 PDUs, power can also be toggled on systems with redundancies by grouping outlets together from different PDUs.

- Turn off outlets that are not in use so that no unplanned additional load can be added to the PDU
- Outlets are numbered for easy identification
- LED next to each outlet indicates on or off status
- Control each outlet on the PDU remotely, which allows you to turn individual outlets off, on or cycle power to the outlet and attached equipment
- Set power cycle delays to prevent power problems or allow a sequenced "power-on" process
- Name outlets to more easily associate outlets with equipment
- Cycle power to groups of outlets to turn power off for several pieces of equipment at once
- Link outlets from several linked PDUs and cycle as if one outlet, allowing one button remote power cycling for redundantly powered equipment

### Specifications:

- Network/External Connections:
  - (1) 10/100 Mbps RJ-45 Ethernet connection (IPv4 and IPv6)
  - (1) RJ11 Environmental Probe connection
  - (1) RJ45 Serial/PDU In linking connection (RS-232)
  - (1) RJ45 PDU Out linking connection
  - (1) USB port for firmware updates
- Internal Metering:
  - Monitors unit voltage, current, power (kW), power factor and energy (kWh) at each breaker; with  $\pm 1\%$  metering accuracy at each breaker
- Local Display:
  - Liquid Crystal Display (LCD) for easy viewing; allows initial setup of IP and subnet addresses without computer
  - Displays unit voltage, current, power and power factor for attached equipment load; separate LED flashes red on alarm
- Network Monitoring:
  - Monitor total voltage, current, power, power factor and energy through the Ethernet using a web browser (HTTP and HTTPS), SSH2 or Telnet, or an application that accepts alarms as SNMP v1, v2c or v3 traps
  - Monitor temperature and humidity when external environmental probe is attached to the PDU, set and automatically monitor high and low alarm thresholds for power, temperature and humidity
  - Log data and events and receive alarm notifications by email
- IP Consolidation (PDU Linking):
  - Use the PDU In/Out connections to link up to 20 PDUs together using standard RJ45 Cat 5/6 patch cords
  - View all connected PDUs through a single network connection and IP address
  - Supports a backup, second network connection through a user assigned PDU
- Switched Outlets:
  - Turn outlets on and off and remotely cycle power to equipment
  - Set initial power on and cycle delays to power multiple outlets on at user defined intervals
  - Link a group of outlets together to toggle power to multiple outlets using a single click

Part Number	Input			Output		Dims - in (mm)		
	Amp	kW*	Plug	Breakers	Outlets	H	W	D
<b>110-125 Volt, Single-Phase PDUs</b>								
P5-1A1A5	20	1.9	IEC C20**	1 x 2P 20A	(24) 5-20R	70.5 (1791)	2.2 (56)	2.2 (56)
P5-1C0A5	20	1.9	NEMA L5-20P	1 x 2P 20A	(24) 5-20R	70.5 (1791)	2.2 (56)	2.2 (56)
P5-1D0A5	30	2.9	NEMA L5-30P	2 x 2P 20A	(24) 5-20R	70.5 (1791)	2.2 (56)	2.2 (56)
<b>110-125 or 200-240 Volt, Single-Phase PDUs</b>								
P5-1A1A1	20	1.9 or 3.3	IEC C20**	1 x 2P 20A	(24) C13	70.5 (1791)	2.2 (56)	2.2 (56)
P5-1A1C3	20	1.9 or 3.3	IEC C20**	1 x 2P 20A	(18) C13, (6) C19	70.5 (1791)	2.2 (56)	2.2 (56)
<b>200-240 Volt, Single-Phase PDUs</b>								
P5-1E0A1	20	3.3	NEMA L6-20P	1 x 2P 20A	(24) C13	70.5 (1791)	2.2 (56)	2.2 (56)
P5-1E0C3	20	3.3	NEMA L6-20P	1 x 2P 20A	(18) C13, (6) C19	70.5 (1791)	2.2 (56)	2.2 (56)
P5-1F0A1	30	5.0	NEMA L6-30P	2 x 2P 20A	(24) C13	70.5 (1791)	2.2 (56)	2.2 (56)
P5-1F0C3	30	5.0	NEMA L6-30P	2 x 2P 20A	(18) C13, (6) C19	70.5 (1791)	2.2 (56)	2.2 (56)
P5-1G0A1	16	2.7	IEC 16A 2P+E	1 x 2P 16A	(24) C13	70.5 (1791)	2.2 (56)	2.2 (56)
P5-1G0C3	16	2.7	IEC 16A 2P+E	1 x 2P 16A	(18) C13, (6) C19	70.5 (1791)	2.2 (56)	2.2 (56)
P5-1H0A1	32	5.3	IEC 32A 2P+E	2 x 2P 16A	(24) C13	70.5 (1791)	2.2 (56)	2.2 (56)
P5-1H0C3	32	5.3	IEC 32A 2P+E	2 x 2P 16A	(18) C13, (6) C19	70.5 (1791)	2.2 (56)	2.2 (56)
<b>120/240 Volt, Split-Phase PDUs (120 Volt Output)</b>								
P5-1N0A5	20	5.8	NEMA L21-20P	3 x 2P 20A	(24) 5-20R	70.5 (1791)	2.2 (56)	2.2 (56)
P5-1P0A5	30	8.6	NEMA L21-30P	3 x 2P 20A	(24) 5-20R	70.5 (1791)	2.2 (56)	2.2 (56)
<b>208 Volt, Three-Phase DELTA PDUs (208 Volt Output)</b>								
P5-1L0A1	20	5.8	NEMA L15-20P	3 x 2P 20A	(24) C13	70.5 (1791)	2.2 (56)	2.2 (56)
P5-1L0C3	20	5.8	NEMA L15-20P	3 x 2P 20A	(18) C13, (6) C19	70.5 (1791)	2.2 (56)	2.2 (56)
P5-1N0A1	20	5.8	NEMA L21-20P	3 x 2P 20A	(24) C13	70.5 (1791)	2.2 (56)	2.2 (56)
P5-1N0C3	20	5.8	NEMA L21-20P	3 x 2P 20A	(18) C13, (6) C19	70.5 (1791)	2.2 (56)	2.2 (56)
P5-1M0A1	30	8.6	NEMA L15-30P	3 x 2P 20A	(24) C13	70.5 (1791)	2.2 (56)	2.2 (56)
P5-1M0C3	30	8.6	NEMA L15-30P	3 x 2P 20A	(18) C13, (6) C19	70.5 (1791)	2.2 (56)	2.2 (56)
P5-1P0A1	30	8.6	NEMA L21-30P	3 x 2P 20A	(24) C13	70.5 (1791)	2.2 (56)	2.2 (56)
P5-1P0C3	30	8.6	NEMA L21-30P	3 x 2P 20A	(18) C13, (6) C19	70.5 (1791)	2.2 (56)	2.2 (56)
P5-1T0A1	50	12.6	50A CS8365C	3 x 2P 20A	(24) C13	70.5 (1791)	2.2 (56)	2.2 (56)
P5-1T0C3	50	12.6	50A CS8365C	3 x 2P 20A	(18) C13, (6) C19	70.5 (1791)	2.2 (56)	2.2 (56)
P5-3U0M3	50	14.4	50A CS8365C	6 X 2P 20A	(12) C13, (12) C19	75.0 (1905)	2.7 (69)	2.2 (56)
P5-3V0M3	60	17.3	IEC 60A 3P+E	6 X 2P 20A	(12) C13, (12) C19	75.0 (1905)	2.7 (69)	2.2 (56)
<b>380-415 Volt, Three-Phase WYE PDUs (200-240 Volt Output)</b>								
P5-1Q0A1	20	11.1	NEMA L22-20P	3 x 2P 20A	(24) C13	70.5 (1791)	2.2 (56)	2.2 (56)
P5-1Q0C3	20	11.1	NEMA L22-20P	3 x 2P 20A	(18) C13, (6) C19	70.5 (1791)	2.2 (56)	2.2 (56)
P5-2R0M3	30	16.6	NEMA L22-30P	6 X 1P 20A	(12) C13, (12) C19	72.0 (1829)	2.4 (61)	2.2 (56)
P5-1W0A1	16	8.9	IEC 16A 3P+N+E	3 x 2P 16A	(24) C13	70.5 (1791)	2.2 (56)	2.2 (56)
P5-1W0C3	16	8.9	IEC 16A 3P+N+E	3 x 2P 16A	(18) C13, (6) C19	70.5 (1791)	2.2 (56)	2.2 (56)
P5-2Y0M3	32	17.7	IEC 32A 3P+N+E	6 x 2P 20A	(12) C13, (12) C19	72.0 (1829)	2.4 (61)	2.2 (56)

Ordering Notes: Order mounting brackets separately. PDUs that are 75"H (1905 mm) must be placed in 45U or taller cabinets.

On Single-Phase PDUs, output voltage equals input voltage. On Split- and Three-Phase PDUs, 208 VAC nominal output through C13 and C19 outlets; 120 VAC nominal output through NEMA 5-20R outlets.

\*For kW column, all values are derated calculations per UL for use in North America. For 50A PDUs, the 50A CS8365C plug is rated for 50A, but maximum input is 35A (12.6 kw) on three breaker PDUs.

\*\*Order power cord separately for PDU with C20 input, see page 7-30.

## Switched Pro eConnect PDU

The Switched Pro eConnect PDU offers remote power monitoring and switching for each individual outlet, environmental monitoring capabilities and tailored alarm thresholds. Whether your goal is energy efficiency, load balancing, capacity planning, branch circuit monitoring or to simply reduce energy costs, Switched Pro eConnect PDUs are the ideal way to measure and manage your data center's success.

- Continuous voltage, current, power and energy monitoring for each outlet on the unit that can be remotely monitored using a web browser
- Control each outlet on the PDU remotely, allowing you to turn individual outlets off, on or cycle power to the outlet and attached equipment
- Includes an external connection for two temperature and humidity sensors for monitoring environmental conditions in your cabinet
- Access the PDU remotely using a web browser for detailed measurements and power totals and to set upper and lower threshold alarms for power, temperature and humidity
- PDU linking feature allows you to connect up to 20 PDUs together and access all of the PDUs using a single IP connection and one IP address
- Forward email alarm notifications and log data and events to keep a record of power use and alarms
- Alternately, monitor the PDU using a third-party software that accepts SNMP traps or through a direct serial connection

### Specifications:

- Network/External Connections:
  - (1) 10/100 Mbps RJ-45 Ethernet connection (IPv4 and IPv6)
  - (1) RJ11 Environmental Probe connection
  - (1) RJ45 Serial/PDU In linking connection (RS-232)
  - (1) RJ45 PDU Out linking connection
  - (1) USB port for firmware updates
- Internal Metering:
  - Monitors unit voltage, current, power (kW), power factor and energy (kWh) at each breaker;  $\pm 1\%$  metering accuracy
- Local Display:
  - Liquid Crystal Display (LCD) for easy viewing; allows initial setup of IP and subnet addresses without computer. Displays unit voltage, current, power and power factor for attached equipment load; separate LED flashes red on alarm
- Network Monitoring:
  - Monitor total voltage, current, power, power factor and energy through the Ethernet using a web browser (HTTP and HTTPS), SSH2 or Telnet, or an application that accepts alarms as SNMP v1, v2c or v3 traps
  - Monitor temperature and humidity when external environmental probe is attached to the PDU, set and automatically monitor high and low alarm thresholds for power, temperature and humidity.
- IP Consolidation (PDU Linking):
  - Use the PDU In/Out connections to link up to 20 PDUs together using standard RJ45 Cat 5/6 patch cords
  - View all connected PDUs through a single network connection and IP address
- Switched/Monitored Outlets:
  - Turn outlets on and off and remotely cycle power to equipment
  - Set initial power on and cycle delays to power multiple outlets on at user defined intervals. Link a group of outlets together to toggle power to multiple outlets using a single click
  - Remotely monitored voltage, current and power at each outlet and total current for each group of outlets

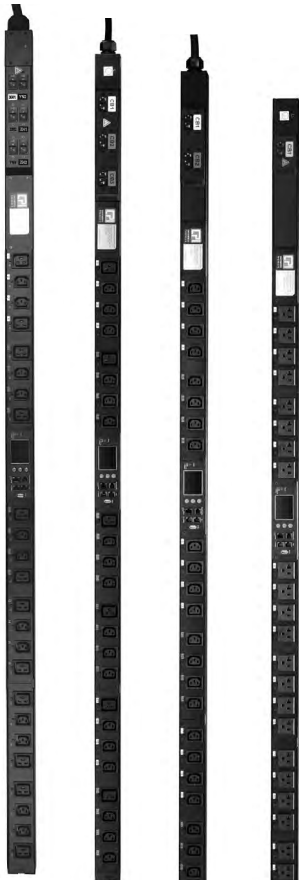

P6-ZROM3  
(12) C13,  
(12) C19

P6-1TOC3  
(18) C13  
(6) C19

P5-1H0A1  
(24) C13

P5-1A1A5  
(24) 5-20R

Switched Pro eConnect PDUs are the only PDUs to include all the features available across the eConnect family – including total and per outlet power monitoring and control, a low-profile chassis and an ambient temperature rating up to 149°F (65°C) at Input Power Rating (kW).

Part Number	Input			Output		Dims - in (mm)		
	Amp	kW*	Plug	Breakers	Outlets	H	W	D
<b>110-125 Volt, Single-Phase PDUs</b>								
P6-1A1A5	20	1.9	IEC C20**	1 x 2P 20A	(24) 5-20R	70.5 (1791)	2.2 (56)	2.2 (56)
P6-1C0A5	20	1.9	NEMA L5-20P	1 x 2P 20A	(24) 5-20R	70.5 (1791)	2.2 (56)	2.2 (56)
P6-1D0A5	30	2.9	NEMA L5-30P	2 x 2P 20A	(24) 5-20R	70.5 (1791)	2.2 (56)	2.2 (56)
<b>110-125 or 200-240 Volt, Single-Phase PDUs</b>								
P6-1A1A1	20	1.9 or 3.3	IEC C20**	1 x 2P 20A	(24) C13	70.5 (1791)	2.2 (56)	2.2 (56)
P6-1A1C3	20	1.9 or 3.3	IEC C20**	1 x 2P 20A	(18) C13, (6) C19	70.5 (1791)	2.2 (56)	2.2 (56)
<b>200-240 Volt, Single-Phase PDUs</b>								
P6-1E0A1	20	3.3	NEMA L6-20P	1 x 2P 20A	(24) C13	70.5 (1791)	2.2 (56)	2.2 (56)
P6-1E0C3	20	3.3	NEMA L6-20P	1 x 2P 20A	(18) C13, (6) C19	70.5 (1791)	2.2 (56)	2.2 (56)
P6-1F0A1	30	5.0	NEMA L6-30P	2 x 2P 20A	(24) C13	70.5 (1791)	2.2 (56)	2.2 (56)
P6-1F0C3	30	5.0	NEMA L6-30P	2 x 2P 20A	(18) C13, (6) C19	70.5 (1791)	2.2 (56)	2.2 (56)
P6-1G0A1	16	2.7	IEC 16A 2P+E	1 x 2P 16A	(24) C13	70.5 (1791)	2.2 (56)	2.2 (56)
P6-1G0C3	16	2.7	IEC 16A 2P+E	1 x 2P 16A	(18) C13, (6) C19	70.5 (1791)	2.2 (56)	2.2 (56)
P6-1H0A1	32	5.3	IEC 32A 2P+E	2 x 2P 16A	(24) C13	70.5 (1791)	2.2 (56)	2.2 (56)
P6-1H0C3	32	5.3	IEC 32A 2P+E	2 x 2P 16A	(18) C13, (6) C19	70.5 (1791)	2.2 (56)	2.2 (56)
<b>120/240 Volt, Split-Phase PDUs (120 Volt Output)</b>								
P6-1N0A5	20	5.8	NEMA L21-20P	3 x 2P 20A	(24) 5-20R	70.5 (1791)	2.2 (56)	2.2 (56)
P6-1P0A5	30	8.6	NEMA L21-30P	3 x 2P 20A	(24) 5-20R	70.5 (1791)	2.2 (56)	2.2 (56)
<b>208 Volt, Three-Phase DELTA PDUs (208 Volt Output)</b>								
P6-1L0A1	20	5.8	NEMA L15-20P	3 x 2P 20A	(24) C13	70.5 (1791)	2.2 (56)	2.2 (56)
P6-1L0C3	20	5.8	NEMA L15-20P	3 x 2P 20A	(18) C13, (6) C19	70.5 (1791)	2.2 (56)	2.2 (56)
P6-1N0A1	20	5.8	NEMA L21-20P	3 x 2P 20A	(24) C13	70.5 (1791)	2.2 (56)	2.2 (56)
P6-1N0C3	20	5.8	NEMA L21-20P	3 x 2P 20A	(18) C13, (6) C19	70.5 (1791)	2.2 (56)	2.2 (56)
P6-1M0A1	30	8.6	NEMA L15-30P	3 x 2P 20A	(24) C13	70.5 (1791)	2.2 (56)	2.2 (56)
P6-1M0C3	30	8.6	NEMA L15-30P	3 x 2P 20A	(18) C13, (6) C19	70.5 (1791)	2.2 (56)	2.2 (56)
P6-1P0A1	30	8.6	NEMA L21-30P	3 x 2P 20A	(24) C13	70.5 (1791)	2.2 (56)	2.2 (56)
P6-1P0C3	30	8.6	NEMA L21-30P	3 x 2P 20A	(18) C13, (6) C19	70.5 (1791)	2.2 (56)	2.2 (56)
P6-1T0A1	50	12.6	50A CS8365C	3 x 2P 20A	(24) C13	70.5 (1791)	2.2 (56)	2.2 (56)
P6-1T0C3	50	12.6	50A CS8365C	3 x 2P 20A	(18) C13, (6) C19	70.5 (1791)	2.2 (56)	2.2 (56)
P6-3U0M3	50	14.4	50A CS8365C	6 X 2P 20A	(12) C13, (12) C19	75.0 (1905)	2.7 (69)	2.2 (56)
P6-3V0M3	60	17.3	IEC 60A 3P+E	6 X 2P 20A	(12) C13, (12) C19	75.0 (1905)	2.7 (69)	2.2 (56)
<b>380-415 Volt, Three-Phase WYE PDUs (200-240 Volt Output)</b>								
P6-1Q0A1	20	11.1	NEMA L22-20P	3 x 2P 20A	(24) C13	70.5 (1791)	2.2 (56)	2.2 (56)
P6-1Q0C3	20	11.1	NEMA L22-20P	3 x 2P 20A	(18) C13, (6) C19	70.5 (1791)	2.2 (56)	2.2 (56)
P6-2R0M3	30	16.6	NEMA L22-30P	6 x 1P 20A	(12) C13, (12) C19	72.0 (1829)	2.4 (61)	2.2 (56)
P6-1W0A1	16	8.9	IEC 16A 3P+N+E	3 x 2P 16A	(24) C13	70.5 (1791)	2.2 (56)	2.2 (56)
P6-1W0C3	16	8.9	IEC 16A 3P+N+E	3 x 2P 16A	(18) C13, (6) C19	70.5 (1791)	2.2 (56)	2.2 (56)
P6-2Y0M3	32	17.7	IEC 32A 3P+N+E	6 x 1P 20A	(12) C13, (12) C19	72.0 (1829)	2.4 (61)	2.2 (56)

Ordering Notes: Order mounting brackets separately. PDUs that are 75"H (1905 mm) must be placed in 45U or taller cabinets. On Single-Phase PDUs, output voltage equals input voltage. On Split- and Three-Phase PDUs, 208 VAC nominal output through C13 and C19 outlets; 120 VAC nominal output through NEMA 5-20R outlets.

\* For kW column, all values are derated calculations per UL for use in North America. For 50A PDUs, the 50A CS8365C plug is rated for 50A, but maximum input is 35A (12.6 kw) on three breaker PDUs.

\*\*Order power cord separately for PDU with C20 input, see page 7-30.

# POWER DISTRIBUTION UNITS (PDUs) – VERTICAL MOUNT

## Power Distribution Units (PDUs) - Vertical Mount

- Four feature levels: Basic, Metered, Monitored, Controlled
- Tool-less mounting on CPI cabinets
- Optional circuit breakers and ammeter with local display for branch monitoring
- Optional network connection with remote monitoring and power cycling
- Single-input models for 110-250 VAC circuits rated up to 60 Amperes
- Single-phase and three-phase plugs
- NEMA-NEMA, NEMA-IEC and IEC-IEC plug-to-receptacle combinations

### Basic, Vertical PDUs

Part Number	Input			Output		Dims - in (mm)		
	Amp	kW	Plug	Breakers	Outlets	H	W	D
<b>110-125 Volt, Single-Phase PDUs</b>								
35643-1A2	30	2.9	NEMA L5-30P	2 x 20A	(24) C13, (6) C19	68.5 (1740)	2.0 (51)	3.5 (89)
<b>200-240 Volt, Single-Phase PDUs</b>								
35622-1A1	20	3.3	NEMA 6-20P	No	(24) C13	68.5 (1740)	2.0 (51)	3.5 (89)
35623-1A1	20	3.3	NEMA L6-30P	2 x 20A	(24) 6-20R	68.5 (1740)	2.0 (51)	3.5 (89)
<b>208 Volt, Three-Phase DELTA PDUs (208 Volt Output)</b>								
35632-1A2	20	5.8	NEMA L21-20P	No	(24) 6-20R	68.5 (1740)	2.0 (51)	3.5 (89)
35633-1B2	30	8.6	NEMA L21-30P	3 x 20A	(24) 6-20R	68.5 (1740)	2.0 (51)	3.5 (89)
35815-1G3	60	12.6	IEC 60A 3P+E	3 x 20A	(42) C13	68.5 (1740)	2.0 (51)	3.5 (89)
35815-1G2	60	12.6	IEC 60A 3P+E	3 x 20A	(15) C13, (9) C19	68.5 (1740)	2.0 (51)	3.5 (89)
35616-1A1	60	17.3	IEC 60A 3P+E	6 x 20A	(12) C19	68.5 (1740)	2.0 (51)	3.5 (89)

Note: Order mounting brackets separately, see page 7-30. For kW column, all values are derated calculations per UL for use in North America. For 60A PDUs, the IEC 60A plug is rated for 60A, but maximum input is 35A (12.6 kw) on three breaker PDUs.

### Metered, Vertical PDUs

Part Number	Input			Output		Dims - in (mm)		
	Amp	kW	Plug	Breakers	Outlets	H	W	D
<b>110-125 Volt, Single-Phase PDUs</b>								
35643-2A1	30	2.9	NEMA L5-30P	2 x 20A	(24) 5-20R	68.5 (1740)	2.0 (51)	3.5 (89)
35643-2A2	30	2.9	NEMA L5-30P	2 x 20A	(24) C13, (6) C19	68.5 (1740)	2.0 (51)	3.5 (89)
<b>200-240 Volt, Single-Phase PDUs</b>								
35623-2A1	20	3.3	NEMA L6-30P	2 x 20A	(24) 6-20R	68.5 (1740)	2.0 (51)	3.5 (89)
35822-2C1	30	5.0	NEMA L6-30P	2 x 15A	(24) C13	68.5 (1740)	2.0 (51)	3.5 (89)
35623-2A2	30	5.0	NEMA L6-30P	2 x 20A	(24) C13, (6) C19	68.5 (1740)	2.0 (51)	3.5 (89)
<b>120/208 Volt, Three-Phase WYE PDUs (208 Volt Output on L6-20R)</b>								
35632-2A1	20	5.8	NEMA L21-20P	No	(24) 5-20R	68.5 (1740)	2.0 (51)	3.5 (89)
35632-2A7	20	5.8	NEMA L21-20P	No	(24) 5-20R, (6) L6-20R	68.5 (1740)	2.0 (51)	3.5 (89)
35633-2A1	30	8.6	NEMA L6-30P	3 x 20A	(24) 5-20R	68.5 (1740)	2.0 (51)	3.5 (89)
<b>208 Volt, Three-Phase DELTA PDUs (208 Volt Output)</b>								
35632-2A2	20	5.8	NEMA L21-20P	No	(24) 6-20R	68.5 (1740)	2.0 (51)	3.5 (89)
35633-2C4	30	8.6	NEMA L15-30P	3 x 20A	(24) C13, (6) C19	68.5 (1740)	2.0 (51)	3.5 (89)
35633-2B2	30	8.6	NEMA L21-30P	3 x 20A	(24) 6-20R	68.5 (1740)	2.0 (51)	3.5 (89)
35815-2G1	60	12.6	IEC 60A 3P+E	3 x 20A	(24) C13	68.5 (1740)	2.0 (51)	3.5 (89)

Note: Order mounting brackets separately. For kW column, all values are derated calculations per UL for use in North America. For 60A PDUs, the IEC 60A plug is rated for 60A, but maximum input is 35A (12.6 kw) on three breaker PDUs.

# POWER DISTRIBUTION UNITS (PDUs) – VERTICAL/RACK MOUNT

## Metered, Vertical PDUs

Part Number	Input			Output		Dims - in (mm)		
	Amp	kW	Plug	Breakers	Outlets	H	W	D
<b>200-240 Volt, Single-Phase PDUs</b>								
35821-3B3	20	3.3	NEMA L6-20P	1 x 20A	(24) C13, (4) C19	68.5 (1740)	2.0 (51)	3.5 (89)
35822-3C3	30	5.0	NEMA L6-30P	2 x 20A	(24) C13, (4) C19	68.5 (1740)	2.0 (51)	3.5 (89)
35821-3A3	16	2.7	IEC 16A 2P+E	1 x 16A	(24) C13, (4) C19	68.5 (1740)	2.0 (51)	3.5 (89)
35823-3G3	32	5.3	IEC 32A 2P+E	2 x 16A	(24) C13, (4) C19	68.5 (1740)	2.0 (51)	3.5 (89)
<b>208 Volt, Three-Phase DELTA PDUs (208 Volt Output)</b>								
35632-3A2	20	5.8	NEMA L21-20P	No	(24) 6-20R	68.5 (1740)	2.0 (51)	3.5 (89)
35633-3B2	30	8.6	NEMA L21-30P	3 x 20A	(24) 6-20R	68.5 (1740)	2.0 (51)	3.5 (89)
35815-3G2	60	12.6	IEC 60A 3P+E	3 x 20A	(15) C13, (9) C19	68.5 (1740)	2.0 (51)	3.5 (89)
35616-3A1	60	17.3	IEC 60A 3P+E	6 x 20A	(12) C19	68.5 (1740)	2.0 (51)	3.5 (89)

Note: Order mounting brackets separately. For kW column, all values are derated calculations per UL for use in North America. For 60A PDUs, the IEC 60A plug is rated for 60A, but maximum input is 35A (12.6 kw) on three breaker PDUs.

## Power Distribution Units (PDUs) - Horizontal, Rack-Mount

### Basic, Horizontal Rack-Mount PDUs

Part Number	Input			Output		Dims - in (mm)		
	Amp	kW	Plug	Breakers	Outlets	H	W	D
<b>110-125 Volt, Single-Phase PDUs</b>								
35692-111	20	1.9	NEMA 5-20P	No	(4) C13, (4) C19	1U	19"EIA	1.9 (48)
35692-121	20	1.9	NEMA L5-20P	No	(4) C13, (4) C19	1U	19"EIA	1.9 (48)
35693-112	30	2.9	NEMA L5-30P	2 x 20A	(12) 5-20R	1U	19"EIA	6.5 (165)
35693-113	30	2.9	NEMA L5-30P	2 x 20A	(20) 5-20R	2U	19"EIA	6.0 (152)
35693-111	30	2.9	NEMA L5-30P	2 x 20A	(12) C13	1U	19"EIA	6.5 (165)
<b>110-125 or 200-240 Volt, Single-Phase PDUs</b>								
35662-112	16	2.7	IEC C20*	No	(10) C13	1U	19"EIA	1.6 (41)
35662-111	16	2.7	IEC C20*	No	(16) C13	1U	19"EIA	4.5 (114)
<b>200-240 Volt, Single-Phase PDUs</b>								
13653-701	20	3.3	NEMA 6-20P	1 x 20A	(12) 6-20R	1U	19"EIA	6.5 (165)
35682-111	20	3.3	NEMA 6-20P	No	(4) C13, (4) C19	1U	19"EIA	1.9 (48)
13653-702	20	3.3	NEMA L6-20P	1 x 20A	(12) 6-20R	1U	19"EIA	6.5 (165)
35682-121	20	3.3	NEMA L6-20P	No	(4) C13, (4) C19	1U	19"EIA	1.9 (48)
35683-111	30	5.0	NEMA L6-30P	2 x 20A	(12) C13	1U	19"EIA	6.5 (165)
35663-111	32	5.3	IEC 32A 2P+E	2 x 16A	(12) C13	1U	19"EIA	6.5 (165)
<b>208 Volt, Three-Phase DELTA PDUs (208 Volt Output)</b>								
35676-111	60	17.3	IEC 60A 3P+E	6 x 20A	(12) C19	2U	19"EIA	9.0 (230)

Note: Includes mounting brackets for 19"EIA rack/cabinet. Order power cord for models with C20 Input separately. For kW column, all values are derated calculations per UL for use in North America. For 60A PDUs, the IEC 60A plug is rated for 60A, but maximum input is 35A (12.6 kw) on three breaker PDUs.

# POWER DISTRIBUTION UNITS (PDUs) – HORIZONTAL MOUNT

## Metered, Horizontal Rack-Mount PDUs

Part Number	Input			Output		Dims - in (mm)		
	Amp	kW	Plug	Breakers	Outlets	H	W	D
<b>110-125 Volt, Single-Phase PDUs</b>								
35692-211	20	1.9	NEMA 5-20P	No	(4) C13, (4) C19	1U	19"EIA	1.9 (48)
35692-221	20	1.9	NEMA L5-20P	No	(4) C13, (4) C19	1U	19"EIA	1.9 (48)
35693-212	30	2.9	NEMA L5-30P	2 x 20A	(12) 5-20R	1U	19"EIA	6.5 (165)
35693-213	30	2.9	NEMA L5-30P	2 x 20A	(20) 5-20R	2U	19"EIA	6.0 (152)
35693-211	30	2.9	NEMA L5-30P	2 x 20A	(12) C13	1U	19"EIA	6.5 (165)
<b>110-125 or 200-240 Volt, Single-Phase PDUs</b>								
35662-212	16	2.7	IEC C20*	No	(10) C13	1U	19"EIA	1.6 (41)
35662-211	16	2.7	IEC C20*	No	(16) C13	1U	19"EIA	4.5 (114)
<b>200-240 Volt, Single-Phase PDUs</b>								
13653-751	20	3.3	NEMA 6-20P	1 x 20A	(12) 6-20R	1U	19"EIA	6.5 (165)
35682-211	20	3.3	NEMA 6-20P	No	(4) C13, (4) C19	1U	19"EIA	1.9 (48)
13653-752	20	3.3	NEMA L6-20P	1 x 20A	(12) 6-20R	1U	19"EIA	6.5 (165)
35682-221	20	3.3	NEMA L6-20P	No	(4) C13, (4) C19	1U	19"EIA	1.9 (48)
35683-211	30	5.0	NEMA L6-30P	2 x 20A	(12) C13	1U	19"EIA	6.5 (165)
35882-2A2	30	5.0	NEMA L6-30P	2 x 15A	(24) C13	2U	19"EIA	8.0 (203)
35663-211	32	5.3	IEC 32A 2P+E	2 x 16A	(12) C13	1U	19"EIA	6.5 (165)

Note: Includes mounting brackets for 19"EIA rack/cabinet. Order power cord for models with C20 Input separately, see page 7-30.

## Monitored, Horizontal Rack-Mount PDUs

Part Number	Input			Output		Dims - in (mm)		
	Amp	kW	Plug	Breakers	Outlets	H	W	D
<b>200-240 Volt, Single-Phase PDUs</b>								
35882-3A1	30	5.0	NEMA L6-30P	2 x 15A	(24) L6-15R	2U	19"EIA	8.0 (203)
35882-3A2	30	5.0	NEMA L6-30P	2 x 15A	(24) C13	2U	19"EIA	8.0 (203)
<b>208 Volt, Three-Phase DELTA PDUs (208 Volt Output)</b>								
35676-311	60	17.3	IEC 60A 3P+E	6 x 20A	(12) C19	2U	19"EIA	9.0 (230)

Note: Includes mounting brackets for 19"EIA rack/cabinet. For kW column, all values are derated calculations per UL for use in North America. For 60A PDUs, the IEC 60A plug is rated for 60A, but maximum input is 35A (12.6 kw) on three breaker PDUs.

## Controlled, Horizontal Rack-Mount PDUs

Part Number	Input			Output		Dims - in (mm)		
	Amp	kW	Plug	Breakers	Outlets	H	W	D
<b>200-240 Volt, Single-Phase PDUs</b>								
35882-5A2	30	5.0	NEMA L6-30P	2 x 15A	(24) C13	1U	19"EIA	28 (711)
35883-5B2	32	5.3	IEC 32A 2P+E	2 x 16A	(24) C13	1U	19"EIA	28 (711)

Note: Includes mounting brackets for 19"EIA 4-post rack or cabinet. Requires front and rear support.

PowerWedge, Controlled PDU  
19" EIA, 4-Post Rack-Mounted  
35882-5A2



## Power Strips

Power Strips distribute single-phase power to multiple pieces of equipment from a single power connection.

- NEMA style outlets and plugs
- Includes a thermal circuit breaker to protect circuits from overload
- Available with surge-protection to protect equipment from power spikes and local meters to provide easy voltage and current monitoring

Part Number	Input			Output		Dims - in (mm)		
	Amp	kW	Plug	Breakers	Outlets	H	W	D
<b>110-125 Volt, Single-Phase Power Strip</b>								
12850-701	15	1.4	NEMA 5-15P	1 x 15A	(14) 5-15R	33.0 (838)	1.7 (43)	1.7 (43)
12848-701	15	1.4	NEMA 5-15P	1 x 15A	(24) 5-15R	66.0 (1676)	1.7 (43)	1.7 (43)
12850-703	15	1.4	NEMA L5-15P	1 x 15A	(14) 5-15R	33.0 (838)	1.7 (43)	1.7 (43)
12848-703	15	1.4	NEMA L5-15P	1 x 15A	(24) 5-15R	66.0 (1676)	1.7 (43)	1.7 (43)
12850-705	20	1.9	NEMA 5-20P	1 x 20A	(14) 5-20R	33.0 (838)	1.7 (43)	1.7 (43)
12848-705	20	1.9	NEMA 5-20P	1 x 20A	(24) 5-20R	66.0 (1676)	1.7 (43)	1.7 (43)
12850-707	20	1.9	NEMA L5-20P	1 x 20A	(14) 5-20R	33.0 (838)	1.7 (43)	1.7 (43)
12848-707	20	1.9	NEMA L5-20P	1 x 20A	(24) 5-20R	66.0 (1676)	1.7 (43)	1.7 (43)
<b>110-125 Volt, Single-Phase Power Strip, Surge-Protected</b>								
12850-702	15	1.4	NEMA 5-15P	1 x 15A	(14) 5-15R	33.0 (838)	1.7 (43)	1.7 (43)
12848-702	15	1.4	NEMA 5-15P	1 x 15A	(24) 5-15R	66.0 (1676)	1.7 (43)	1.7 (43)
12850-704	15	1.4	NEMA L5-15P	1 x 15A	(14) 5-15R	33.0 (838)	1.7 (43)	1.7 (43)
12848-704	15	1.4	NEMA L5-15P	1 x 15A	(24) 5-15R	66.0 (1676)	1.7 (43)	1.7 (43)
12850-706	20	1.9	NEMA 5-20P	1 x 20A	(14) 5-20R	33.0 (838)	1.7 (43)	1.7 (43)
12848-706	20	1.9	NEMA 5-20P	1 x 20A	(24) 5-20R	66.0 (1676)	1.7 (43)	1.7 (43)
12850-708	20	1.9	NEMA L5-20P	1 x 20A	(14) 5-20R	33.0 (838)	1.7 (43)	1.7 (43)
12848-708	20	1.9	NEMA L5-20P	1 x 20A	(24) 5-20R	66.0 (1676)	1.7 (43)	1.7 (43)

Notes: Includes rack mounting brackets and tool-less hardware. All power strips have IEC C20 inlets and include a power cord. Cords with locking plugs are 10'L (3 m). Cords with straight plugs are 8'2"L (2.4 m). Order mounting brackets for cabinets separately.

## Metered Power Strips, Vertical Mount

Part Number	Input			Output		Dims - in (mm)		
	Amp	kW	Plug	Breakers	Outlets	H	W	D
<b>110-125 Volt, Single-Phase Power Strip</b>								
12848-751	15	1.4	NEMA 5-15P	1 x 15A	(24) 5-15R	66.0 (1676)	1.7 (43)	1.7 (43)
12848-755	20	1.9	NEMA 5-20P	1 x 20A	(24) 5-20R	66.0 (1676)	1.7 (43)	1.7 (43)
12848-757	20	1.9	NEMA L5-20P	1 x 20A	(24) 5-20R	66.0 (1676)	1.7 (43)	1.7 (43)
<b>110-125 Volt, Single-Phase Power Strip, Surge-Protected</b>								
12848-752	15	1.4	NEMA 5-15P	1 x 15A	(24) 5-15R	66.0 (1676)	1.7 (43)	1.7 (43)
12848-754	15	1.4	NEMA L5-15P	1 x 15A	(24) 5-15R	66.0 (1676)	1.7 (43)	1.7 (43)
12848-756	20	1.9	NEMA 5-20P	1 x 20A	(24) 5-20R	66.0 (1676)	1.7 (43)	1.7 (43)
12848-758	20	1.9	NEMA L5-20P	1 x 20A	(24) 5-20R	66.0 (1676)	1.7 (43)	1.7 (43)

Notes: Includes rack mounting brackets and tool-less hardware. All power strips have IEC C20 inlets and include a power cord. Cords with locking plugs are 10'L (3 m). Cords with straight plugs are 8'2"L (2.4 m). Order mounting brackets for cabinets separately.



# POWER STRIPS – HORIZONTAL, RACK-MOUNT

## Basic Power Strips, Horizontal Rack-Mount

Part Number	Input			Output		Dims - in (mm)		
	Amp	kW	Plug	Breakers	Outlets	H	W	D
<b>110-125 Volt, Single-Phase Power Strip</b>								
12816-701	15	1.4	NEMA 5-15P	1 x 15A	(8) 5-15R	1U	19"EIA/23"	1.4 (36)
12816-702	15	1.4	NEMA L5-15P	1 x 15A	(8) 5-15R	1U	19"EIA/23"	1.4 (36)
12816-705	20	1.9	NEMA 5-20P	1 x 20A	(8) 5-20R	1U	19"EIA/23"	1.4 (36)
12816-706	20	1.9	NEMA L5-20P	1 x 20A	(8) 5-20R	1U	19"EIA/23"	1.4 (36)
<b>110-125 Volt, Single-Phase Power Strip, Surge-Protected</b>								
12816-703	15	1.4	NEMA 5-15P	1 x 15A	(6) 5-15R	1U	19"EIA/23"	1.4 (36)
12816-704	15	1.4	NEMA L5-15P	1 x 15A	(6) 5-15R	1U	19"EIA/23"	1.4 (36)
12816-707	20	1.9	NEMA 5-20P	1 x 20A	(6) 5-20R	1U	19"EIA/23"	1.4 (36)
12816-708	20	1.9	NEMA L5-20P	1 x 20A	(6) 5-20R	1U	19"EIA/23"	1.4 (36)

Notes: Includes 19"EIA and 23"W horizontal rack-mount brackets. All power strips have IEC C20 inlets and include a power cord. Cords with locking plugs are 10'L (3 m). Cords with straight plugs are 8'2"L (2.4 m).

## Metered Power Strips, Horizontal Rack-Mount

Part Number	Input			Output		Dims - in (mm)		
	Amp	kW	Plug	Breakers	Outlets	H	W	D
<b>110-125 Volt, Single-Phase Power Strip</b>								
13239-751	15	1.4	NEMA 5-15P	1 x 15A	(12) 5-15R	1U	19"EIA	4.6 (117)
13239-755	20	1.9	NEMA 5-20P	1 x 20A	(12) 5-20R	1U	19"EIA	4.6 (117)
13239-756	20	1.9	NEMA L5-20P	1 x 20A	(12) 5-20R	1U	19"EIA	4.6 (117)
<b>110-125 Volt, Single-Phase Power Strip, Surge-Protected</b>								
13239-753	15	1.4	NEMA 5-15P	1 x 15A	(12) 5-15R	1U	19"EIA	4.6 (117)
13239-757	20	1.9	NEMA 5-20P	1 x 20A	(12) 5-20R	1U	19"EIA	4.6 (117)
13239-758	20	1.9	NEMA L5-20P	1 x 20A	(12) 5-20R	1U	19"EIA	4.6 (117)

Notes: Includes 19"EIA horizontal rack-mount brackets only. All power strips have IEC C20 inlets and include a power cord. Cords with locking plugs are 10'L (3 m). Cords with straight plugs are 8'2"L (2.4 m).

## Basic Power Strips, for CUBE-iT PLUS® Cabinet System

Part Number	Input			Output		Dims - in (mm)		
	Amp	kW	Plug	Breakers	Outlets	H	W	D
<b>110-125 Volt, Single-Phase Power Strip</b>								
12820-701	15	1.4	NEMA 5-15P	1 x 15A	(8) 5-15R	19.2 (488)	1.8 (44)	8.2 (208)
12820-702	15	1.4	NEMA L5-15P	1 x 15A	(8) 5-15R	19.2 (488)	1.8 (44)	8.2 (208)
12820-705	20	1.9	NEMA 5-20P	1 x 20A	(8) 5-20R	19.2 (488)	1.8 (44)	8.2 (208)
12820-706	20	1.9	NEMA L5-20P	1 x 20A	(8) 5-20R	19.2 (488)	1.8 (44)	8.2 (208)
<b>110-125 Volt, Single-Phase Power Strip, Surge-Protected</b>								
12820-703	15	1.4	NEMA 5-15P	1 x 15A	(6) 5-15R	19.2 (488)	1.8 (44)	8.2 (208)
12820-704	15	1.4	NEMA L5-15P	1 x 15A	(6) 5-15R	19.2 (488)	1.8 (44)	8.2 (208)
12820-707	20	1.9	NEMA 5-20P	1 x 20A	(6) 5-15R	19.2 (488)	1.8 (44)	8.2 (208)
12820-708	20	1.9	NEMA L5-20P	1 x 20A	(6) 5-15R	19.2 (488)	1.8 (44)	8.2 (208)

Notes: Dimensions include mounting bracket in vertical orientation. The Power Strip is 17"H (432 mm) x 1.7"W (43 mm) x 1.4"D (36 mm). All power strips have IEC C20 inlets and include a power cord. Cords with locking plugs are 10'L (3 m). Cords with straight plugs are 8'2"L (2.4 m).







## International Power Strips

CPI International Power Strips provide basic power distribution into racks and cabinets, allowing you to share a single power connection with multiple pieces of equipment. Available in two configurations: basic and metered. Basic Power Strips feature a master lighted switch or optional thermal circuit breaker and surge protection. Circuit breakers limit the amount of current available to equipment, while surge protection blocks excessive voltage from equipment. Both features are critical with unconditioned line power. Metered configurations include an in-line digital voltage and ammeter with display to show the amount of voltage and current being used by attached equipment. This feature allows the user to monitor voltage and current use and judge the amount of remaining capacity on the power strip before adding a new device to the circuit.







- **Circuit Control:**
  - Master lighted switch on horizontal rack-mount power strips
- **Circuit Protection:**
  - Thermal circuit breakers on vertical mount power strips
- **Optional Surge Protection**
  - 330 Volt, 1100 Joules
  - Surge suppression active indicator LED
- **Current Metering:**
  - Digital voltage and ammeter included on metered power strips
  - Meter has a 3-digit LED display
  - Overload alarm/flashing LED at breaker rating
- **Certifications:**
  - CE Marked
- **Mounting hardware/brackets:**
  - Horizontal rack-mount power strips include mounting brackets for 19" EIA and 23" wide racks
  - Vertical mount power strips include tool-less buttons; order mounting

### International Power Strip Plug & Receptacle/Outlet Table

#### Plug & Receptacle Configurations Plug Inlet, Universal/Locking

			
IEC C20 230-250 VAC/16A	IEC 16A 2P+E 230-250 VAC/16A	IEC 32A 2P+E 230-250 VAC/32A	BS 1363 (UK) 230-250 VAC/13A

#### Power Receptacle/Outlet Table: Receptacles/Outlets

						
IEC C13 230-250 VAC/10A	IEC C19 230-250 VAC/16A	BS 1363 (UK) 230-250 VAC/13A	Schuko DIN49440 230-250 VAC/16A	Universal GB2009.3 230-250 VAC/10A	CH GB1002 230-250 VAC/10A	CH GB1002 230-250 VAC/16A

# INTERNATIONAL POWER STRIPS – VERTICAL

## Basic Power Strips, Vertical Mount

Part Number	Input			Output		Dims - in (mm)		
	Amp	kW	Plug	Breakers	Outlets	H	W	D
<b>220-250 Volt, Single-Phase Power Strip</b>								
15642-202	16	4.0	IEC C20	1 x 16A	(10) C13, (4) C19	43.1 (1095)	2.5 (64)	1.8 (46)
15642-206	16	4.0	IEC C20	1 x 16A	(12) UK BS1363 13A	48.3 (1227)	2.5 (64)	1.8 (46)
15642-212	16	4.0	IEC 16A 2P+E	1 x 16A	(10) C13, (4) C19	43.1 (1095)	2.5 (64)	1.8 (46)
15642-216	16	4.0	IEC 16A 2P+E	1 x 16A	(12) UK BS1363 13A	48.3 (1227)	2.5 (64)	1.8 (46)
15642-222	32	8.0	IEC 32A 2P+E	2 x 16A	(10) C13, (4) C19	48.3 (1227)	2.5 (64)	1.8 (46)
15642-226	32	8.0	IEC 32A 2P+E	2 x 16A	(12) UK BS1363 13A	53.4 (1357)	2.5 (64)	1.8 (46)
15642-232	13	3.3	UK BS1363	1 x 13A	(10) C13, (4) C19	43.1 (1095)	2.5 (64)	1.8 (46)
15642-236	13	3.3	UK BS1363	1 x 13A	(12) UK BS1363 13A	48.3 (1227)	2.5 (64)	1.8 (46)
15644-202	16	4.0	IEC C20	1 x 16A	(20) C13, (4) C19	61.3 (1557)	2.5 (64)	1.8 (46)
15644-205	16	4.0	IEC C20	1 x 16A	(24) Schuko DIN49440 16A	61.0 (1549)	1.8 (46)	2.7 (69)
15644-207	16	4.0	IEC C20	1 x 16A	(24) Universal GB2009.3 10A	61.3 (1557)	2.5 (64)	1.8 (46)
15644-208	16	4.0	IEC C20	1 x 16A	(20) CH GB1002 10A, (4) 16A	61.3 (1557)	2.5 (64)	1.8 (46)
15644-212	16	4.0	IEC 16A 2P+E	1 x 16A	(20) C13, (4) C19	61.3 (1557)	2.5 (64)	1.8 (46)
15644-215	16	4.0	IEC 16A 2P+E	1 x 16A	(24) Schuko DIN49440 16A	61.0 (1549)	1.8 (46)	2.7 (69)
15644-217	16	4.0	IEC 16A 2P+E	1 x 16A	(24) Universal GB2009.3 10A	61.3 (1557)	2.5 (64)	1.8 (46)
15644-218	16	4.0	IEC 16A 2P+E	1 x 16A	(20) CH GB1002 10A, (4) 16A	61.3 (1557)	2.5 (64)	1.8 (46)
15644-222	32	8.0	IEC 32A 2P+E	2 x 16A	(20) C13, (4) C19	66.5 (1689)	2.5 (64)	1.8 (46)
15644-225	32	8.0	IEC 32A 2P+E	2 x 16A	(24) Schuko DIN49440 16A	64.8 (1646)	1.8 (46)	2.7 (69)
15644-227	32	8.0	IEC 32A 2P+E	2 x 16A	(24) Universal GB2009.3 10A	66.5 (1689)	2.5 (64)	1.8 (46)
15644-228	32	8.0	IEC 32A 2P+E	2 x 16A	(20) CH GB1002 10A, (4) 16A	66.5 (1689)	2.5 (64)	1.8 (46)
15644-232	13	3.3	UK BS1363	1 x 13A	(20) C13, (4) C19	61.3 (1557)	2.5 (64)	1.8 (46)
15644-237	13	3.3	UK BS1363	1 x 13A	(24) Universal GB2009.3 10A	61.3 (1557)	2.5 (64)	1.8 (46)
<b>220-250 Volt, Single-Phase Power Strip, Surge-Protected</b>								
15642-102	16	4.0	IEC C20	1 x 16A	(10) C13, (4) C19	43.1 (1095)	2.5 (64)	1.8 (46)
15642-106	16	4.0	IEC C20	1 x 16A	(12) UK BS1363 13A	48.3 (1227)	2.5 (64)	1.8 (46)
15642-112	16	4.0	IEC 16A 2P+E	1 x 16A	(10) C13, (4) C19	43.1 (1095)	2.5 (64)	1.8 (46)

Notes: All power strips have attached 10'L (3 m) power cord.



15644-222 shown

Part Number	Input			Output		Dims - in (mm)		
	Amp	kW	Plug	Breakers	Outlets	H	W	D
<b>220-250 Volt, Single-Phase Power Strip, Surge-Protected</b>								
15644-102	16	4.0	IEC C20	1 x 16A	(20) C13, (4) C19	61.3 (1557)	2.5 (64)	1.8 (46)
15644-105	16	4.0	IEC C20	1 x 16A	(24) Schuko DIN49440 16A	61.0 (1549)	1.8 (46)	2.7 (69)
15644-107	16	4.0	IEC C20	1 x 16A	(24) Universal GB2009.3 10A	61.3 (1557)	2.5 (64)	1.8 (46)
15644-108	16	4.0	IEC C20	1 x 16A	(20) CH GB1002 10A, (4) 16A	61.3 (1557)	2.5 (64)	1.8 (46)
15644-112	16	4.0	IEC 16A 2P+E	1 x 16A	(20) C13, (4) C19	61.3 (1557)	2.5 (64)	1.8 (46)
15644-115	16	4.0	IEC 16A 2P+E	1 x 16A	(24) Schuko DIN49440 16A	61.0 (1549)	1.8 (46)	2.7 (69)
15644-117	16	4.0	IEC 16A 2P+E	1 x 16A	(24) Universal GB2009.3 10A	61.3 (1557)	2.5 (64)	1.8 (46)
15644-118	16	4.0	IEC 16A 2P+E	1 x 16A	(20) CH GB1002 10A, (4) 16A	61.3 (1557)	2.5 (64)	1.8 (46)
15644-122	32	8.0	IEC 32A 2P+E	2 x 16A	(20) C13, (4) C19	66.5 (1689)	2.5 (64)	1.8 (46)
15644-125	32	8.0	IEC 32A 2P+E	2 x 16A	(24) Schuko DIN49440 16A	64.8 (1646)	1.8 (46)	2.7 (69)
15644-127	32	8.0	IEC 32A 2P+E	2 x 16A	(24) Universal GB2009.3 10A	66.5 (1689)	2.5 (64)	1.8 (46)
15644-128	32	8.0	IEC 32A 2P+E	2 x 16A	(20) CH GB1002 10A, (4) 16A	66.5 (1689)	2.5 (64)	1.8 (46)
15644-132	13	3.3	UK BS1363	1 x 13A	(20) C13, (4) C19	61.3 (1557)	2.5 (64)	1.8 (46)
15644-137	13	3.3	UK BS1363	1 x 13A	(24) Universal GB2009.3 10A	61.3 (1557)	2.5 (64)	1.8 (46)

Notes: All power strips have attached 10L (3 m) power cord.

## Metered Power Strips, Vertical Mount

Part Number	Input			Output		Dims - in (mm)		
	Amp	kW	Plug	Breakers	Outlets	H	W	D
<b>220-250 Volt, Single-Phase Power Strip</b>								
15643-202	16	4.0	IEC C20	1 x 16A	(10) C13, (4) C19	43.1 (1095)	2.5 (64)	1.8 (46)
15643-206	16	4.0	IEC C20	1 x 16A	(12) UK BS1363 13A	48.3 (1227)	2.5 (64)	1.8 (46)
15643-212	16	4.0	IEC 16A 2P+E	1 x 16A	(10) C13, (4) C19	43.1 (1095)	2.5 (64)	1.8 (46)
15643-216	16	4.0	IEC 16A 2P+E	1 x 16A	(12) UK BS1363 13A	48.3 (1227)	2.5 (64)	1.8 (46)
15643-222	32	8.0	IEC 32A 2P+E	2 x 16A	(10) C13, (4) C19	48.3 (1227)	2.5 (64)	1.8 (46)
15643-226	32	8.0	IEC 32A 2P+E	2 x 16A	(12) UK BS1363 13A	53.4 (1357)	2.5 (64)	1.8 (46)
15643-232	13	3.3	UK BS1363	1 x 13A	(10) C13, (4) C19	43.1 (1095)	2.5 (64)	1.8 (46)
15643-236	13	3.3	UK BS1363	1 x 13A	(12) UK BS1363 13A	48.3 (1227)	2.5 (64)	1.8 (46)
15645-202	16	4.0	IEC C20	1 x 16A	(20) C13, (4) C19	61.3 (1557)	2.5 (64)	1.8 (46)
15645-205	16	4.0	IEC C20	1 x 16A	(24) Schuko DIN49440 16A	61.0 (1549)	1.8 (46)	2.7 (69)
15645-207	16	4.0	IEC C20	1 x 16A	(24) Universal GB2009.3 10A	61.3 (1557)	2.5 (64)	1.8 (46)
15645-208	16	4.0	IEC C20	1 x 16A	(20) CH GB1002 10A, (4) 16A	61.3 (1557)	2.5 (64)	1.8 (46)
15645-212	16	4.0	IEC 16A 2P+E	1 x 16A	(20) C13, (4) C19	61.3 (1557)	2.5 (64)	1.8 (46)
15645-215	16	4.0	IEC 16A 2P+E	1 x 16A	(24) Schuko DIN49440 16A	61.0 (1549)	1.8 (46)	2.7 (69)
15645-217	16	4.0	IEC 16A 2P+E	1 x 16A	(24) Universal GB2009.3 10A	61.3 (1557)	2.5 (64)	1.8 (46)
15645-218	16	4.0	IEC 16A 2P+E	1 x 16A	(20) CH GB1002 10A, (4) 16A	61.3 (1557)	2.5 (64)	1.8 (46)
15645-222	32	8.0	IEC 32A 2P+E	2 x 16A	(20) C13, (4) C19	66.5 (1689)	2.5 (64)	1.8 (46)
15645-225	32	8.0	IEC 32A 2P+E	2 x 16A	(24) Schuko DIN49440 16A	64.8 (1646)	1.8 (46)	2.7 (69)
15645-227	32	8.0	IEC 32A 2P+E	2 x 16A	(24) Universal GB2009.3 10A	66.5 (1689)	2.5 (64)	1.8 (46)
15645-228	32	8.0	IEC 32A 2P+E	2 x 16A	(20) CH GB1002 10A, (4) 16A	66.5 (1689)	2.5 (64)	1.8 (46)
15645-232	13	3.3	UK BS1363	1 x 13A	(20) C13, (4) C19	61.3 (1557)	2.5 (64)	1.8 (46)
15645-237	13	3.3	UK BS1363	1 x 13A	(24) Universal GB2009.3 10A	61.3 (1557)	2.5 (64)	1.8 (46)

# INTERNATIONAL POWER STRIPS – VERTICAL

## Metered Power Strips, Vertical Mount

Part Number	Input			Output		Dims - in (mm)		
	Amp	kW	Plug	Breakers	Outlets	H	W	D
<b>220-250 Volt, Single-Phase Power Strip, Surge-Protected</b>								
15643-102	16	4.0	IEC C20	1 x 16A	(10) C13, (4) C19	43.1 (1095)	2.5 (64)	1.8 (46)
15643-106	16	4.0	IEC C20	1 x 16A	(12) UK BS1363 13A	48.3 (1227)	2.5 (64)	1.8 (46)
15643-112	16	4.0	IEC 16A 2P+E	1 x 16A	(10) C13, (4) C19	43.1 (1095)	2.5 (64)	1.8 (46)
15643-116	16	4.0	IEC 16A 2P+E	1 x 16A	(12) UK BS1363 13A	48.3 (1227)	2.5 (64)	1.8 (46)
15643-122	32	8.0	IEC 32A 2P+E	2 x 16A	(10) C13, (4) C19	48.3 (1227)	2.5 (64)	1.8 (46)
15643-126	32	8.0	IEC 32A 2P+E	2 x 16A	(12) UK BS1363 13A	53.4 (1357)	2.5 (64)	1.8 (46)
15643-132	13	3.3	UK BS1363	1 x 13A	(10) C13, (4) C19	43.1 (1095)	2.5 (64)	1.8 (46)
15643-136	13	3.3	UK BS1363	1 x 13A	(12) UK BS1363 13A	48.3 (1227)	2.5 (64)	1.8 (46)
15645-102	16	4.0	IEC C20	1 x 16A	(20) C13, (4) C19	61.3 (1557)	2.5 (64)	1.8 (46)
15645-105	16	4.0	IEC C20	1 x 16A	(24) Schuko DIN49440 16A	61.0 (1549)	1.8 (46)	2.7 (69)
15645-107	16	4.0	IEC C20	1 x 16A	(24) Universal GB2009.3 10A	61.3 (1557)	2.5 (64)	1.8 (46)
15645-108	16	4.0	IEC C20	1 x 16A	(20) CH GB1002 10A, (4) 16A	61.3 (1557)	2.5 (64)	1.8 (46)
15645-112	16	4.0	IEC 16A 2P+E	1 x 16A	(20) C13, (4) C19	61.3 (1557)	2.5 (64)	1.8 (46)
15645-115	16	4.0	IEC 16A 2P+E	1 x 16A	(24) Schuko DIN49440 16A	61.0 (1549)	1.8 (46)	2.7 (69)
15645-117	16	4.0	IEC 16A 2P+E	1 x 16A	(24) Universal GB2009.3 10A	61.3 (1557)	2.5 (64)	1.8 (46)
15645-118	16	4.0	IEC 16A 2P+E	1 x 16A	(20) CH GB1002 10A, (4) 16A	61.3 (1557)	2.5 (64)	1.8 (46)
15645-122	32	8.0	IEC 32A 2P+E	2 x 16A	(20) C13, (4) C19	66.5 (1689)	2.5 (64)	1.8 (46)
15645-125	32	8.0	IEC 32A 2P+E	2 x 16A	(24) Schuko DIN49440 16A	64.8 (1646)	1.8 (46)	2.7 (69)
15645-127	32	8.0	IEC 32A 2P+E	2 x 16A	(24) Universal GB2009.3 10A	66.5 (1689)	2.5 (64)	1.8 (46)
15645-128	32	8.0	IEC 32A 2P+E	2 x 16A	(20) CH GB1002 10A, (4) 16A	66.5 (1689)	2.5 (64)	1.8 (46)
15645-132	13	3.3	UK BS1363	1 x 13A	(20) C13, (4) C19	61.3 (1557)	2.5 (64)	1.8 (46)
15645-137	13	3.3	UK BS1363	1 x 13A	(24) Universal GB2009.3 10A	61.3 (1557)	2.5 (64)	1.8 (46)

Notes: All power strips have attached 10'L (3 m) power cord.



## Vertical PDU Mounting Bracket Kit

Used to attach Vertical PDUs to CPI Cabinet and Rack Systems.

- Each Mounting Bracket Kit includes a pair of mounting brackets to support the PDU.

Part Number	Description	Shipping Weight lb (kg)
35700-701	For Rack Systems	2 (0.9)

Note: Mounting Kits are included with CPI Cabinets.

## Basic Power Strips, Horizontal Mount

Part Number	Input			Output		Dims - in (mm)		
	Amp	kW	Plug	Control	Outlets	H	W	D
<b>220-250 Volt, Single-Phase Power Strip</b>								
15640-201	16	4.0	IEC C20	Master Lighted Switch	(10) C13	1U	19"EIA/23"	1.8 (46)
15640-202	16	4.0	IEC C20	Master Lighted Switch	(6) C13, (4) C19	1U	19"EIA/23"	4.6 (117)
15640-203	16	4.0	IEC C20	Master Lighted Switch	(4) C19	1U	19"EIA/23"	1.8 (46)
15640-204	16	4.0	IEC C20	Master Lighted Switch	(6) CH GB1002 10A	1U	19"EIA/23"	1.8 (46)
15640-205	16	4.0	IEC C20	Master Lighted Switch	(6) Schuko DIN49440 16A	1U	19"EIA/23"	1.8 (46)
15640-206	16	4.0	IEC C20	Master Lighted Switch	(6) UK BS1363 13A	1U	19"EIA/23"	1.8 (46)
15640-207	16	4.0	IEC C20	Master Lighted Switch	(6) Universal GB2009.3 10A	1U	19"EIA/23"	1.8 (46)
15640-211	16	4.0	IEC 16A 2P+E	Master Lighted Switch	(10) C13	1U	19"EIA/23"	1.8 (46)
15640-212	16	4.0	IEC 16A 2P+E	Master Lighted Switch	(6) C13, (4) C19	1U	19"EIA/23"	4.6 (117)
15640-213	16	4.0	IEC 16A 2P+E	Master Lighted Switch	(4) C19	1U	19"EIA/23"	1.8 (46)
15640-214	16	4.0	IEC 16A 2P+E	Master Lighted Switch	(6) CH GB1002 10A	1U	19"EIA/23"	1.8 (46)
15640-215	16	4.0	IEC 16A 2P+E	Master Lighted Switch	(6) Schuko DIN49440 16A	1U	19"EIA/23"	1.8 (46)
15640-216	16	4.0	IEC 16A 2P+E	Master Lighted Switch	(6) UK BS1363 13A	1U	19"EIA/23"	1.8 (46)
15640-217	16	4.0	IEC 16A 2P+E	Master Lighted Switch	(6) Universal GB2009.3 10A	1U	19"EIA/23"	1.8 (46)
15640-231	13	3.3	UK BS1363	Master Lighted Switch	(10) C13	1U	19"EIA/23"	1.8 (46)
15640-232	13	3.3	UK BS1363	Master Lighted Switch	(6) C13, (4) C19	1U	19"EIA/23"	4.6 (117)
15640-236	13	3.3	UK BS1363	Master Lighted Switch	(6) UK BS1363 13A	1U	19"EIA/23"	1.8 (46)

Notes: Includes 19"EIA and 23"W horizontal rack-mount brackets. All power strips have a lighted master switch (no breaker) and an attached 10'L (3 m) cord.



15640-211 shown



15640-236 shown



17763-007 shown.



17763-010 shown.



17763-013 shown.

## IEC C20 PDU Input Power Cords

Input power cords for use with eConnect PDUs, PDUs and Power Strips that have IEC C20 inlets.

- Select power cord to match power connection in the facility
- IEC C19 Connector attaches to the C20 Inlet on the PDU
- Sold individually, order one power cord per PDU

Part Number	Description	Shipping Weight lb (kg)
17763-001	PDU Input Power Cord, 110-125 VAC or 200-240 VAC, IEC C19 Connector to IEC C20 Plug, 10'L (3 m)	3 (1.4)
17763-002	PDU Input Power Cord, 110-125 VAC, IEC C19 Connector to NEMA 5-15P Plug, 8'2"L (2.4 m)	3 (1.4)
17763-003	PDU Input Power Cord, 110-125 VAC, IEC C19 Connector to NEMA 5-20P Plug, 8'2"L (2.4 m)	3 (1.4)
17763-004	PDU Input Power Cord, 200-240 VAC, IEC C19 Connector to NEMA 6-15P Plug, 8'2"L (2.4 m)	3 (1.4)
17763-005	PDU Input Power Cord, 200-240 VAC, IEC C19 Connector to NEMA 6-20P Plug, 8'2"L (2.4 m)	3 (1.4)
17763-006	PDU Input Power Cord, 110-125 VAC, IEC C19 Connector to NEMA L5-15P Plug, 10'L (3 m)	3 (1.4)
17763-007	PDU Input Power Cord, 110-125 VAC, IEC C19 Connector to NEMA L5-20P Plug, 10'L (3 m)	3 (1.4)
17763-008	PDU Input Power Cord, 200-240 VAC, IEC C19 Connector to NEMA L6-15P Plug, 10'L (3 m)	3 (1.4)
17763-009	PDU Input Power Cord, 200-240 VAC, IEC C19 Connector to NEMA L6-20P Plug, 10'L (3 m)	3 (1.4)
17763-010	PDU Input Power Cord, 200-240 VAC, IEC C19 Connector to IEC 16A 2P+E Plug, 10'L (3 m)	3 (1.4)
International Plugs		
17763-011	PDU Input Power Cord, 200-240 VAC, IEC C19 Connector to 16A CEE7/7 Schuko Plug (Europe), 8'2"L (2.4 m)	3 (1.4)
17763-012	PDU Input Power Cord, 200-240 VAC, IEC C19 Connector to BS1363 Plug (Britains), 8'2"L (2.4 m)	3 (1.4)
17763-013	PDU Input Power Cord, 200-240 VAC, IEC C19 Connector to CEI23 Plug (Italian), 8'2"L (2.4 m)	3 (1.4)

See the Output and Input Plug Table on page 7-4 for plug diagrams.



## Environmental Probe and Temperature Humidity Sensor

Monitored, Switched and Pro eConnect PDUs include a single external connection that can attach up to two Environmental Probes using a splitter. When attached, the PDU will report temperature and humidity measurements for each probe on the local display and remotely through the built-in web interface.

- Sold individually or in a kit with two probes and a splitter
- Each probe is a combination temperature and humidity sensor with attached 6'L (1.8 m) cord, allowing the sensor to be positioned appropriately within the cabinet

Part Number	Description	Shipping Weight lb (kg)
17761-003	(2) Environmental Probes with (1) Temperature and (1) Humidity Sensor Kit with splitter 72"L (1828 mm) x 2"H (50 mm) x 2"W (50 mm)	1 (0.5)
17761-001	Environmental Probe with (1) Temperature and (1) Humidity Sensor 72"L (1828 mm) x 1"H (25 mm) x 1"W (25 mm)	1 (0.5)
17761-002	Environmental Probe Splitter 6"L (152 mm) x 2"H (50 mm) x 2"W (50 mm)	1 (0.5)

*Note: You can attach one probe directly to the PDU; the splitter is required to attach two probes.*



39110-C01



13780-C01



25140-701



35700-701



13762-701

## Vertical PDU Mounting Bracket Kit

Used to attach Vertical PDUs to CPI Cabinet and Rack Systems.

- Each Mounting Bracket Kit includes a pair of mounting brackets to support the PDU
- Brackets for Cabinet Systems support two 2.2"W (56 mm) PDUs side-by-side or one 2.7"W (69 mm) PDU
- PDUs that are 75"H (1905 mm) must be placed in 44U or taller cabinets
- Select the kit to match the cabinet or rack model.

Part Number	Description	Shipping Weight lb (kg)
39110-C01	For F-Series TeraFrame Gen 3 Cabinet System or GF-Series GlobalFrame Gen 2 Cabinet System	2 (0.9)
13780-C01	For F-Series TeraFrame Gen 2 Cabinet System	2 (0.9)
25140-701	For GF-Series GlobalFrame Gen 1 Cabinet System	2 (0.9)
13762-701	For M-Series MegaFrame Cabinet System or C-Series SlimFrame Cabinet System	2 (0.9)
35700-701	For Rack Systems, supports (1) PDU	2 (0.9)

*Note: Mounting Kits are included with CPI Cabinets.*



## PowerScope In-Line Meter

Use the PowerScope In-Line Meter in data centers, computer and equipment rooms to upgrade existing basic or metered PDUs with network-based current monitoring. PowerScope attaches between the power connection and PDU and measures total current use by equipment attached to the PDU. It features an Ethernet connection, which allows current monitoring through an IP connection using a web browser or third-party software that support SNMPv1 protocol. It also has an external temperature and humidity sensor connection. Connect the environmental sensor (sold separately) to monitor temperature and humidity conditions in the cabinet.

- Match the Plug/Connector style to the PDU; power cords are 3'L (1 m)
- CPI PowerScope In-Line Meter is available in a 1U horizontal rack-mount configuration only, optional local meters

Part Number	Input			Output		Dims - in (mm)		
	Amp	kW	Plug	Local Meter	Connections	H	W	D
<b>For 110-125 Volt, Single-Phase PDUs</b>								
35992-100	20	1.9	(2) NEMA L5-20P	No	(2) L5-20R	1U	19"EIA	9.0 (230)
35992-120	20	1.9	(2) NEMA L5-20P	Yes	(2) L5-20R	1U	19"EIA	9.0 (230)
35992-200	30	2.9	(2) NEMA L5-30P	No	(2) L5-30R	1U	19"EIA	9.0 (230)
35992-220	30	2.9	(2) NEMA L5-30P	Yes	(2) L5-30R	1U	19"EIA	9.0 (230)
<b>For 200-240 Volt, Single-Phase PDUs</b>								
35992-301	20	3.3	(2) NEMA L6-20P	No	(2) L6-20R	1U	19"EIA	9.0 (230)
35991-311	20	3.3	(1) NEMA L6-20P	Yes	(1) L6-20R	1U	19"EIA	9.0 (230)
35991-312	16	2.7	(1) IEC 16A 2P+E	Yes	(1) IEC 16A 2P+E	1U	19"EIA	9.0 (230)
35992-321	20	3.3	(2) NEMA L6-20P	Yes	(2) L6-20R	1U	19"EIA	9.0 (230)
35992-322	16	2.7	(2) IEC 16A 2P+E	Yes	(2) IEC 16A 2P+E	1U	19"EIA	9.0 (230)
35992-401	30	5.0	(2) NEMA L6-30P	No	(2) L6-30R	1U	19"EIA	9.0 (230)
35991-411	30	5.0	(1) NEMA L6-30P	Yes	(1) L6-30R	1U	19"EIA	9.0 (230)
35991-412	32	5.3	(1) IEC 32A 2P+E	Yes	(1) IEC 32A 2P+E	1U	19"EIA	9.0 (230)
35992-421	30	5.0	(2) NEMA L6-30P	Yes	(2) L6-30R	1U	19"EIA	9.0 (230)
35992-422	32	5.3	(2) IEC 32A 2P+E	Yes	(2) IEC 32A 2P+E	1U	19"EIA	9.0 (230)
<b>For 120/208 Volt, Three-Phase WYE PDUs</b>								
35993-405	30	8.6	(1) L21-30P	No	(1) L21-30R	1U	19"EIA	9.0 (230)
<b>For 208 Volt, Three-Phase DELTA PDUs</b>								
35993-404	30	8.6	(1) L15-30P	No	(1) L15-30R	1U	19"EIA	9.0 (230)
35993-603	50	12.6	(1) 50A CS8365C	No	(1) 50A CS8375	1U	19"EIA	9.0 (230)

Note: Includes mounting brackets for 19"EIA rack/cabinet. Input/output cords are 3'L (1 m). For kW column, all values are derated calculations per UL for use in North America. For 50A, the CS8365C 50A plug is rated for 50A, but maximum input is 35A (12.6 kw) on three breaker PDUs.



PowerScope In-Line Meter front and rear views





## IT-Series 600-2000VA UPS

IT-Series is a line interactive UPS that provides cost-effective, high-quality power protection for a wide range of applications. Available in 19" Rack-Mount and Tower models.

- True sine wave, line interactive design
- AVR Buck and Boost voltage regulation
- Equipped with RS-232 and USB Ports and communication slot
- Monitoring and management software included
- Front panel has (6) LEDs for quick visual notification
- Fully digitized, microprocessor-controlled
- Cold Start (DC Power On); SNMP communication ready
- Hot swappable, user-replaceable batteries

Part Number	Description
<b>(VA, Watts, VAC, Input Plug, Outlets, Full-Load On Battery Runtime)</b>	
CPI0600ITSIR	Rack-Mount, 600VA/360W, 120V, 5-15P, (4) 5-15R, 14 min.
CPI1000ITSIR	Rack-Mount, 1000VA/600W, 120V, 5-15P, (4) 5-15R, 6 min.
CPI1500ITSIR	Rack-Mount, 1500VA/900W, 120V, 5-15P, (6) 5-15R, 6 min.
CPI2000ITSIR	Rack-Mount, 2000VA/1200W, 120V, 5-20P, (6) 5-15R, 6 min.
CPI0600ITSIT	Tower, 600VA/360W, 120V, 5-15P, (4) 5-15R, 14 min.
CPI1000ITSIT	Tower, 1000VA/600W, 120V, 5-15P, (4) 5-15R, 6 min.
CPI1500ITSIT	Tower, 1500VA/900W, 100-120 VAC, NEMA 5-15P Plug, (6) 5-15R, 6 min.
CPI2000ITSIT	Tower, 2000VA/1200W, 100-120 VAC, NEMA 5-20P Plug, (6) 5-15R, 6 min.
CPIITSNMP	SNMP/Web Interface Plug-In Card
CPI-19IN-RAILKIT	Rail Kit, 19" EIA Rack-Mount



## VH Series UPS, 120V

The VH Series UPS connects between the utility and the critical load to ensure that if the utility fails, the load continues to receive constant, reliable power. UPS is a true VFI (Voltage and Frequency Independent) on-line double conversion, transformerless UPS.

- 2U design, unique failsafe internal bypass
- Superior battery management and optional remote monitoring
- MTBF > 730,000 hours
- Increased power handling (0.9) output power factor

Part Number	Description
<b>(VA, Watts, VAC, Input Plug, Outlets, Full-Load On Battery Runtime)</b>	
CPI25510	700VA/630W, 120V, 5-15P, (4) 5-15R, 8 min.
CPI25511	1000VA/900W, 120V, 5-15P, (6) 5-15R, 8 min.
CPI25512	1500VA/1350W, 120V, 5-15P, (6) 5-15R, 7 min.
CPI25513	1920VA/1740W, 120V, 5-20P, (6) 5-15R, (1) L5-20R, 8 min.
CPI25268	Expansion Battery, 1000VA UPS
CPI25269	Expansion Battery, 1500VA/1920VA UPS
CPI1019070	SNMP/Web Interface Plug-in Card
CPI-19IN-RAILKIT	Rail Kit, 19" EIA Rack-Mount

Order the rail kit with rack-mount models.

# UNINTERRUPTIBLE POWER SUPPLY (UPS)



Order the rail kit with rack-mount models.



## GT-Series 1000-3000VA UPS

The GT-Series is a true VFI (Voltage and Frequency Independent), on-line double conversion high performance device providing high-quality power protection.

- High input power factor (>.97) and low input distortion
- Utilizes high-frequency PWM (Pulse Width Modulation) resulting in low output distortion and fast transient response
- Designed to handle short-circuit, high overload and overheating conditions
- High Crest Factor capability makes it ideal for computer loads
- Wide input voltage range minimizes switching, increasing battery life

Part Number	Description
(VA, Watts, VAC, Input Plug, Outlets, Full-Load On Battery Runtime)	
CPI16180	Rack-Mount, 3000VA/2400W, 120V, L5-30P, (8) 5-20R/(1) L5-30R, 5 min.
CPI16166	Tower, 3000VA/2400W, 120V, L5-30P, (6) 5-20R/(1) L5-30R, 5 min.
CPI16171	Tower, 3000VA/2400W, 208V, L6-20P, (4) 6-20R/(1) L6-20R, 5 min.
CPI16327	Expansion Battery Pack, Rack-Mount Model
CPI16323	Expansion Battery Pack, Tower Model
CPI16400	SNMP Plug-in Card
CPI-19IN-RAILKIT	Rail Kit, 19" EIA Rack-Mount



Order the rail kit to rack-mount the UPS.



## GT-Series 5000-6000VA UPS

This GT-Series is a transformerless UPS that protects critical equipment from any fluctuation in your power source with a true VFI (Voltage and Frequency Independent) on-line double conversion. Unit design can be rack-mounted or used as a standalone tower.

- Auto Sensing 50/60 Hz, extending runtime options
- RS-232 port and contact interface device with SNMP card slot

Part Number	Description
(VA, Watts, VAC, Input Plug, Outlets, Full-Load On Battery Runtime)	
CPI23913UB	UPS, 5000VA/4200W, 240/208/120 VAC, Requires PDU, 6 min.
CPI23914UB	UPS, 6000VA/4200W, 240/208/120 VAC, Requires PDU, 6 min.
CPI1020621	PDU, Terminal Block (TB) in, TB out, No Bypass
CPI1020622	PDU, TB in, TB out, Bypass
CPI1020623	PDU L14-30P in,(4) 5-20R/(1) L6-30R/(1) L14-30R out
CPI1020624	PDU, L14-30P in,(2) 5-20R/(2) L6-20R out
CPI1020625	PDU, L14-30P in,(4) 5-20R/(2) L6-30R out
CPI1020626	PDU, L14-30P in,(4) C13 out
CPI1020627	PDU L14-30P in,(4) L5-20R/(2) L5-30R out
CPI1020628	PDU, L14-30P in,(4) L5-20R/(2) L6-30R out
CPI1020629	PDU, L14-30P in,(4) L6-20R out
CPI23916EBM	Expansion Battery Pack
CPI16327	Expansion Battery Pack, Rack-Mount Model
CPI23954	SNMP/Web Interface Plug-in Card
CPI-19IN-RAILKIT	Rail Kit, 19" EIA Rack-Mount



Order the rail kit with rack-mount models.



## GT-Series 8000-10000VA UPS

GT-Series 8000-10000VA UPS protects equipment from any fluctuation in your power source and is a true VFI (Voltagess and Frequency Independent) on-line double conversion, transformerless UPS. Unit design can be rack-mounted or used as a standalone tower.

- Auto Sensing 50/60 Hz, extended runtime options
- RS-232 port and contact interface device with SNMP Slot
- Includes monitoring and operation software
- User replaceable hot swappable batteries
- Unit can be expanded to create a parallel system
- Parallel N+2 of N+1 redundancy

Part Number	Description
<b>(VA, Watts, VAC, Input Plug, Outlets, Full-Load On Battery Runtime)</b>	
CPI23917UB	UPS, 8000VA/6900W, 240/208/120 VAC, Requires PDU, 6 min.
CPI23918UB	UPS, 10000VA/8000W, 240/208/120 VAC, Requires PDU, 6 min.
CPI1020660	PDU, Terminal Block (TB) in, (8) 5-20R/(2) L6-30R out
CPI1020661	PDU, TB in, (4) 5-20R/(4) L6-20R out
CPI1020662	PDU, TB in, (4) 5-20R/(4) L6-30R out
CPI1020663	PDU, TB in, (4) 5-20R/(2) L6-20R/(2) L6-30R out
CPI1020664	PDU, TB in, (4) 5-20R/(2) L5-20R/(2) L6-30R out
CPI1020665	PDU, TB in, (4) L5-20R/(4) L6-20R out
CPI23920EBM	Expansion Battery Pack
CPI23954	SNMP/Web Interface Plug-in Card
CPI-19IN-RAILKIT	Rail Kit, 19" EIA Rack-Mount



## LP-11U Series UPS

The LP-11U Series is a robust, high-performance system that operates in a double conversion mode with true on-line VFI (Voltage and Frequency Independent) operation. Design makes it suitable for industrial applications.

- Redundant Parallel Architecture (RPA) technology allows the unit to parallel up to four units
- High input power factor (.99) and low input distortion (<10%) prevents disturbances to other equipment
- Utilizes Pulse Width Modulation (PWM) digital control technique

Part Number	Description
<b>(VA, Watts, VAC, Input Plug, Outlets, Full-Load On Battery Runtime)</b>	
CPI105LP2230000	Tower, 5000VA/4000W, 120/208-240 VAC, HW, HW, 8 min.
CPI106LP2230000	Tower, 6000VA/4800 VA, 120/208-240V, HW, HW, 11 min.
CPI108LP2230000	Tower, 8000VA/6400W, 120/208-240V, HW, HW, 8 min.
CPI110LP2230000	Tower, 10000VA/8000W, 120/208-240V, HW, HW, 8 min.
CPI12434	Additional Battery Cabinet, 7Ah
CPI12438	Additional Battery Cabinet, 14Ah
CPI1019070	SNMP/Web Interface Plug-in Card
CPI12458	RS232 / Contact Interface
CPI12351	RPA Kit (order one per UPS)

# RACK SYSTEMS

Racks, Rack Enclosures, Shelves & Accessories



Universal Rack

Standard Rack

Adjustable Rail, 4-Post Rack

Adjustable, 4-Post Rack

Fixed, 4-Post Rack

Shelves for Racks

Keyboard Trays

Installation Products

Additional Accessories

High-Density Patching Frame

Page 8-3

Page 8-7

Page 8-10

Page 8-13

Page 8-17

Page 8-20

Page 8-26

Page 8-29

Page 8-31

Page 8-39

# RACK SYSTEMS

Advances in technology are moving information faster and faster every day. However, no matter how advanced or involved a network becomes, it can all come to a halt if not supported by a sturdy rack. Building a proven record of supporting these complex network configurations through standout products, like the cost-effective Adjustable QuardraRack®, CPI's industry-leading Rack Systems deliver the confidence of unsurpassed strength, stability and durability. From multiple patch panels, to cabling and other equipment, CPI Rack Systems keep equipment safe and secure.

Designed and built with a commitment to quality, CPI Rack Systems can also be quickly adapted for your changing needs, with the addition of shelves or special brackets engineered to hold larger devices and computer hardware, such as servers and switches. Enclosures can be added to some Rack Systems as well, which improve security for your equipment.

## **CPI Rack Systems feature:**

- High-quality construction and design
- Fixed mounting rails, most with rack-mount unit markings, ideal for support of patch panels, termination blocks and other equipment
- Standard EIA-310-D hole pattern
- Small footprint saves floor space
- Unrestricted airflow for maximum ventilation
- Easy access to cables for moves, adds and changes
- Large variety of styles, sizes and accessories for various configurations
- High static load ratings; 750 lb (340.2 kg) to 2200 lb (1000.0 kg)

## **Featured Product:**

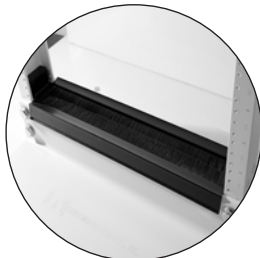

*KoldLok® 2-Post Rack Grommet  
Page 8-34*



Ground Studs located directly on rack channel



Rack-Mount Unit (U) marks simplify equipment installation

## Universal Rack

### Features:

- High-strength, lightweight aluminum extrusion construction
- Two top angles or top bars and heavy-duty assembly hardware for stronger rack to handle heavier loading
- 50 special #12-24 mounting screws with combination Phillips/Straight heads and pilot points to reduce cross threading and installation time
- Unique packaging inserts eliminate damage from components hitting together in the carton during shipping and handling; racks are packed unassembled in individual cartons
- Ease of assembly is enhanced through use of threaded channels; no hex nuts are required
- Universal 5/8"-5/8"-1/2" (15.9 mm-15.9 mm-12.7 mm) alternating hole pattern offers greater mounting flexibility, maximizes usable mounting space and is compatible with conventional wide 1-1/4"-1/2" (31.8 mm -12.7 mm) alternating hole patterns
- Integrated masked grounding studs on the inside of the rack channel for quick attachment to the Telecommunications Grounding System
- Available in powder coat color finishes: Gray, Computer Beige, Black, Glacier White or grained aluminum finish (Clear)
- State-of-the-art manufacturing methods provide the best quality and fastest delivery in the industry
- Side channels have multiple mounting holes and (4) pem nuts for quick installation of cable management
- EIA Channels: C-Shaped, 1.265" x 3" (32.13 mm x 76 mm); .25" (6.4 mm) thick front/rear flanges; .17" (4.3 mm) thick web (pair)
- Base Angles: 3.5" x 6.0" x .375" (89 mm x 152 mm x 9.53 mm) thick (pair)
- Top Angles: 1.5" x 1.5" x .25" (38 mm x 38 mm x 6.4 mm) thick (pair)
- Top Angles, Flush Bolted: 1.5" x 2.0" x .25 (38 mm x 51 mm x 6.4 mm) thick
- Top Bars: 1.5" x .25" (38 mm x 6.4 mm) thick (pair)
- Panel Mounting Holes: #12-24 rolled threads in both flanges front and back
- Custom configurations and assemblies available by special order
- Assembly hardware is included
- Select models (P/N 48353-XXX, 48383-XXX) are UL Listed: File E140851; Category DUXR (US), DUXR7 (Canada) – Communications Circuit Accessory
- Weight capacity 1500 lb (680.4 kg) — weight must be evenly distributed, and rack must be properly secured to floor

*Installation Hint: When mounting equipment, use #3 Phillips tip to assure maximum torque.*

## Channel Cross Section and Hole Pattern

### Standards

CPI offers EIA aluminum channel uprights on all Standard and Universal racks. All Standard and Universal racks are threaded to accept industry standard #12-24 mounting screws. Extra care is taken in that the threads are "rolled" rather than "cut" for greater strength and durability. The Universal Rack hole pattern is 5/8"-5/8"-1/2" (15.9 mm-15.9 mm-12.7 mm) and is compatible with wide 1 1/4"-1/2" (31.8 mm-12.7 mm) patterns, while offering greater flexibility.

# UNIVERSAL RACK

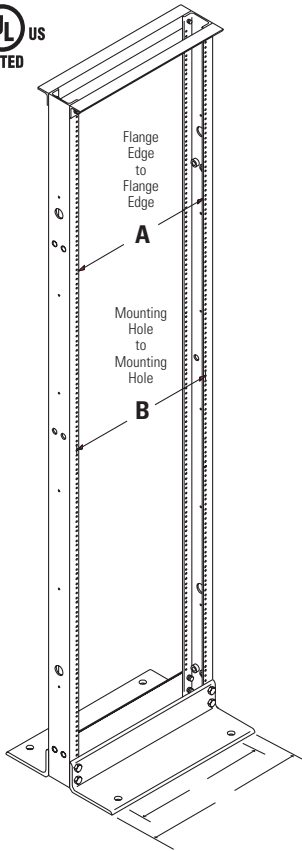

Dimension	19" EIA Rack in (mm)	23" EIA Rack in (mm)
A	17.75 (450.9)	21.75 (552.5)
B	18.31 (465.1)	22.31 (566.7)
C	16 (410.0)	20 (510.0)
D	20.31 (515.9)	24.31 (617.5)

Shipping Weights - lb (kg)	
6' (1.8 m) Rack	37 (16.8)
7' (2.1 m) Rack	39 (17.7)
8' (2.4 m) Rack	41 (18.6)

## Universal Rack Ordering Matrix

- UL Listed racks offered in multiple heights and 19" or 23" widths
- For heavy-duty, high-capacity installations

Top Bar or Angles	
460	Two Top Bars
463	Two Top Angles
467	Two Top Angles, Flush Bolted
483	UL Listed (With Two Top Angles)

Width - in	
5	19 EIA Channel
8	23 Channel

Mounting Holes	
3	Mounting Holes Both Sides

Color	
1	Gray
2	Computer Beige
5	Clear
7	Black
E	Glacier White

Height		
31	3 (0.9)	17U
20	4 (1.2)	24U
19	5 (1.5)	31U
00	5.6 (1.7)	34U
01	6 (1.8)	38U
02	6.6 (2.0)	41U
03	7 (2.1)	45U
05	7.6 (2.3)	48U
15	8 (2.4)	51U
17	8.6 (2.6)	55U
08	9 (2.7)	58U

4XX X X - X XX

Top View of Base Angle

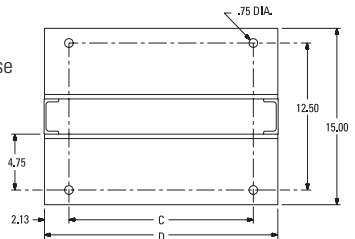



## 35" x 3" (889 mm x 80 mm) Universal Rack

Universal Rack in a 35" (889 mm) frame width supports block hardware.

- High-strength aluminum construction
- Supplied with two top angles for maximum strength
- EIA-310-D Standard Universal 5/8"-5/8"-1/2" (15.9 mm-15.9 mm-12.7 mm) alternating hole pattern offers greater mounting flexibility and is fully compatible with conventional wide 1-1/4"-1/2" (31.8 mm-12.7 mm) alternating hole patterns
- Four channel holes per side allow multiple racks to be firmly mounted together side by side
- High-strength roll-formed threaded mounting holes
- Rack-mount unit marks simplify equipment installation
- Includes 50 pilot point #12-24 mounting screws with combination Phillips/Straight heads
- Integrated masked grounding studs on the inside of the rack channel for quick attachment to the Telecommunications Grounding System
- Ships unassembled, individually packaged with assembly and installation instructions included; bulk packaging is also available
- Supports up to 1500 lb (680.4 kg)

*Note: Accessory shelves are not available for this rack.*

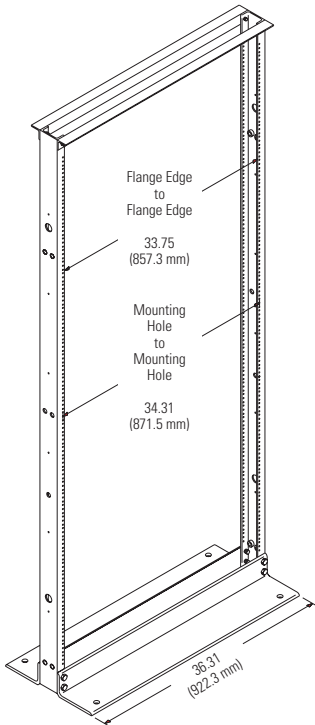

Ground Studs located directly on rack channel



Rack-Mount Unit (U) marks simplify equipment installation

Top Bar or Angles	
463	Two Top Angles
467	Two Top Angles, Flush Bolted

Width - in	
6	35 EIA Channel

Mounting Holes	
3	Mounting Holes Both Sides

Color	
1	Gray
2	Computer Beige
5	Clear
7	Black
E	Glacier White

Height		
01	6 (1.8)	38U
03	7 (2.1)	45U

46X	6	3	-	X	0X
-----	---	---	---	---	----

Shipping Weights - lb (kg)	
6' (1.8 m) Rack	49 (22.2)
7' (2.1 m) Rack	51 (23.1)

# UNIVERSAL RACK

## Dimensions:

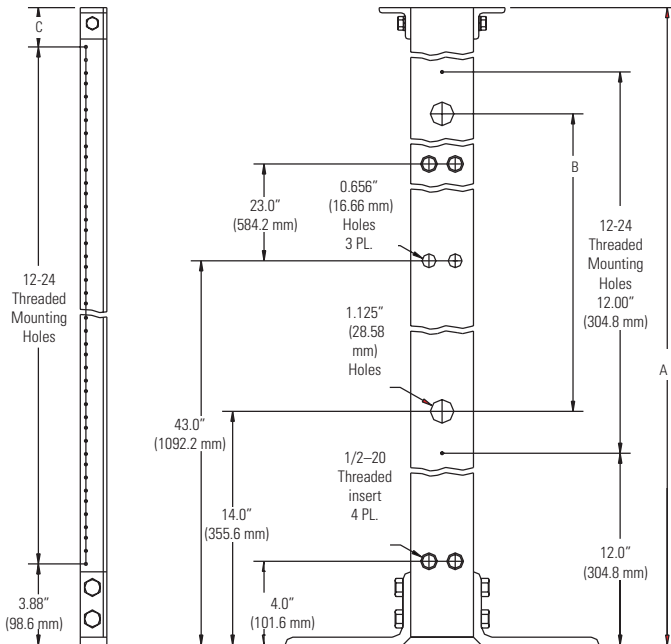

Front and Rear Flanges  
(both sides drilled)

Web Surface  
7' (2.1 m) Universal Rack

Rack Height Dimension A ft (m)	Dimension B in (mm)	Dimension C in (mm)	Number of Mounting Holes	Number of Mounting Spaces
3 (0.9)	N/A	1.75 (44.5)	53	17
4 (1.2)	N/A	2.13 (54.1)	72	24
5 (1.5)	43 (1090)	1.88 (47.8)	94	31
5.6 (1.7)	44 (1120)	2.00 (50.8)	104	34
6 (1.8)	56 (1420)	2.12 (53.8)	114	38
6.6 (2.0)	56 (1420)	1.75 (44.5)	125	41
7 (2.1)	56 (1420)	1.87 (47.5)	135	45
7.6 (2.3)	56 (1420)	2.62 (66.5)	144	48
8 (2.4)	72 (1830)	2.25 (57.2)	155	51
8.6 (2.6)	72 (1830)	2.38 (60.5)	165	55
9 (2.7)	72 (1830)	2.00 (50.8)	176	58

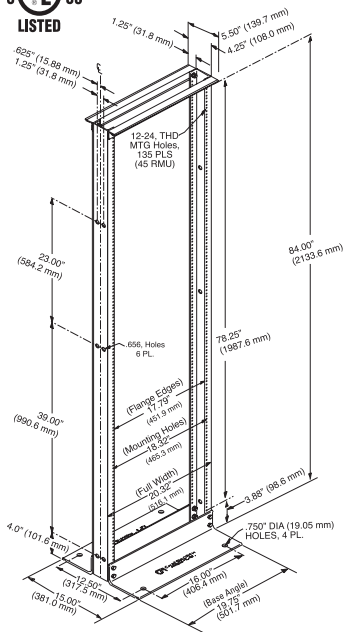

## Standard Rack 3”D (80 mm)

The Standard Rack is designed for value conscious, high-volume customers, who require the quality and service that sets CPI racks apart from the competition. The Standard Rack is a UL Listed communication circuit accessory, designed specifically for use in telecommunications equipment installations where codes require UL Listed equipment racks. For a greater breadth of features, we recommend CPI Universal Racks.

- High-strength aluminum construction
- Shipped with (2) top angles, (2) base angles, (2) 3”D (80 mm) equipment channels and installation hardware
- Top angles allow J-bolt attachment without interfering with top rack-mount spaces
- EIA-310-D Standard Universal 5/8”-5/8”-1/2” (15.9 mm-15.9 mm-12.7 mm) alternating hole pattern offers greater mounting flexibility and is fully compatible with conventional wide 1-1/4”-1/2” (31.8 mm-12.7 mm) alternating hole patterns
- Six web channel holes per side enable multiple racks to be mounted together side by side or attachment of cable managers
- Integrated masked grounding studs on the inside of the rack channel for quick attachment to the Telecommunications Grounding System
- High-strength roll-formed threaded mounting holes
- Rack-mount unit marks simplify equipment installation
- Includes 50 pilot point #12-24 mounting screws with combination Phillips/Straight heads to reduce cross-threading and installation time
- Available in powder coat color finishes: Gray, Computer Beige, Black, Glacier White or grained aluminum finish (Clear)
- Ships unassembled, individually packaged, with assembly hardware and installation instructions; bulk packaging is also available
- Redesigned shipping container saves space and freight costs
- Choose from three heights
- Weight capacity of 1000 lb (453.6 kg) — weight must be evenly distributed, and rack must be properly secured to the floor
- UL Listed; File E140851; Category DUXR (US), DUXR7 (Canada) – Communications Circuit Accessory



Ground Studs located directly on rack channel



Rack-Mount Unit (U) marks simplify equipment installation

Part Number	Description H x W Height - ft (m)	Shipping Weight lb (kg)
55053-X03	7 (2.1) x 19”, 45U	31 (14.1)
55053-X15	8 (2.4) x 19”, 52U	37 (16.8)
55053-X08	9 (2.7) x 19”, 58U	40 (18.1)

X=color: 1=Gray, 2=Computer Beige, 5=Clear, 7=Black, E=Glacier White

# STANDARD RACK

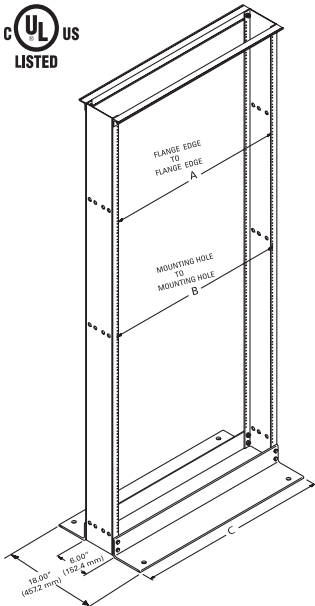

P/N 66363 (35" W) Shown:  
 The 6"D (150 mm) Standard Rack is the high-capacity frame that is designed for use with cabling sections and is the basic frame around which the XLBET/MDF frames are developed.

## Standard Rack 6"D (150 mm)

Features 6"D (150 mm) upright mounting channels for MDF, IDF and other high-capacity distribution frame applications. The additional rack depth provides extra room for high-density equipment and cable needs.

- High-strength aluminum construction
- Supplied with (2) top angles for additional strength
- EIA-310-D Standard Universal 5/8"-5/8"-1/2" (15.9 mm-15.9 mm-12.7 mm) alternating hole pattern offers greater mounting flexibility and is fully compatible with conventional wide 1-1/4"-1/2" (31.8 mm-12.7 mm) alternating hole patterns
- Rack-mount unit marks simplify equipment installation
- High-strength, roll-formed threaded mounting holes
- Ships unassembled and individually packaged
- Integrated masked grounding studs on the inside of the rack channel for quick attachment to the Telecommunications Grounding System
- Includes assembly hardware and (50) pilot point #12-24 mounting screws with combination Phillips/Straight heads
- Weight capacity 1000 lb (453.6 kg) — weight must be evenly distributed and rack must be properly secured to the floor
- UL Listed; File E140851; Category DUXR (US), DUXR7 (Canada) — Communications Circuit Accessory

Part Number	Description H x W Height - ft (m)	Shipping Weight lb (kg)
66353-X03	7 (2.1) x 19", 45U	38 (17.2)
66383-X03	7 (2.1) x 23", 45U	42 (19.1)
66363-X03	7 (2.1) x 35", 45U	52 (23.6)

X=color: 1=Gray, 2=Computer Beige, 5=Clear, 7=Black, E=Glacier White

Rack Dimensions			
Dimension	19" EIA Rack in (mm)	23" EIA Rack in (mm)	35" EIA Rack in (mm)
A	17.79 (451.9)	21.79 (553.5)	33.79 (858.3)
B	18.31 (465.1)	22.31 (566.7)	34.31 (871.5)
C	20.31 (515.9)	24.31 (617.5)	36.31 (922.3)

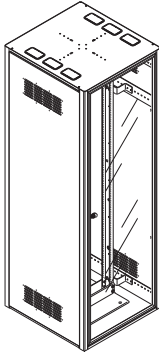

Rack Enclosure

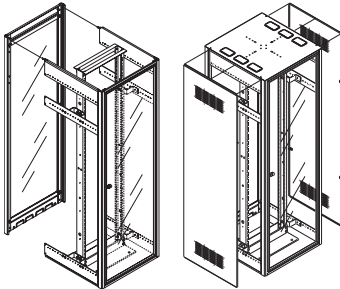

Single Rack Enclosure

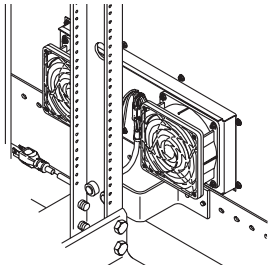

P/N 11755-001

Standard side-mounted enclosure fan kit includes (2) complete fan assemblies with an attached cord with NEMA 5-15P plug.

## Single Rack Enclosures

Enclose a single rack, while leaving ample room for wire and cable. The aluminum top panel with six edge-protected punch-out ports provides cabling access wherever needed. Run cable through the back panel by removing one of four cable access plates located along the bottom kick plate.

- Convenient cable access with removable sides, rear-kick panel and cut-out top sections
- Lockable plexiglass or metal doors are easily reversible
- Top and side panels can be removed in minutes to provide access to interior
- Ships partially assembled in one 14" x 32" x 89" (360 mm x 810 mm x 2260 mm) carton to minimize shipping and handling costs
- Shipping weight approximately 135 lb (61.2 kg)

Single Rack Enclosure	
110	Plexiglass Doors on Enclosure

Rack Width	
38	19"
48	23"

Color	
2	Computer Beige
7	Black
E	Glacier White

Rack Height - ft (m)	
06	6 (1.8) With Side Panels
07	7 (2.1) With Side Panels
96	6 (1.8) Without Side Panels
97	7 (2.1) Without Side Panels

110	XX	-	X	XX
-----	----	---	---	----

Metal Door Rack Enclosure	
11558	For 19" Rack - Metal Enclosure Doors

Color	
2	Computer Beige
7	Black
E	Glacier White

Rack Height - ft (m)	
06	6 (1.8) With Side Panels
07	7 (2.1) With Side Panels
96	6 (1.8) Without Side Panels
97	7 (2.1) Without Side Panels

11558	-	X	XX
-------	---	---	----

Fan Kit for Single Rack Enclosures	
11755-001	Fan Kit, 400 CFM, 115 VAC, 50/60 Hz, 0.19 Amp, NEMA 5-15P Plug, Components are UL & ROHS approved
11222-001	Replacement Filter Kit

# ADJUSTABLE RAIL 4-POST RACK



## Adjustable Rail QuadraRack® (ARQR) and Adjustable Rail ServerRack (ARSR)

The Adjustable Rail QuadraRack® (ARQR) and the Adjustable Rail ServerRack (ARSR) provide a sturdy, feature-rich solution for supporting rack-mount network, computer server and data storage equipment in data centers, computer equipment rooms and other IT facilities. Both racks offer the strength and stability of an enclosure in an open four-post mounting system that provides easy access to equipment and cabling.

The front and rear frames are welded to speed up assembly and increase strength. Four brackets connect the front and rear corners of the frames. Front mounting rails attach to the front frame in a fixed position and align with the front of the rack or can be reversed for recessed mounting to maximize side-to-side airflow through network switches. Rear mounting rails are adjustable in depth and can extend beyond the rear of the frame. A second set of holes along the sides of the frame lets you add optional side-mounted equipment support rails and vertical power strips that are independent of the mounting rails and use no rack-mount space. The bottom of the rack is punched for easy floor attachment.

Each rack includes a Top-Mount Cable Waterfall Tray with adjustable radius drops to allow easy side-to-side routing for patch cords. Use with any CPI cabling section (vertical cable manager) or Cable Guide Kits to organize cables along the sides of the rack. Attach CPI Cable Runway to the top of the rack with J-Bolts, a Cable Runway Elevation Kit or a Cable Runway Mounting Bracket to support overhead premise cables. A side panel is also available.

### Features:

- Available in three heights and two depths
- Adjustable Rail QuadraRack (ARQR) has threaded mounting holes that speed up installation of patch panels, fiber enclosures and network switches.
- Adjustable Rail ServerRack (ARSR) has square-punched mounting rails that allow you to change mounting hardware (cage nuts) to match specific computer server and data storage equipment mounting requirements
- Each rack-mount unit is marked and numbered
- Front pair of mounting rails may be mounted to allow rack-mount unit numbering to start at the top or bottom of the rack
- Rear mounting rail adjusts in depth
- UL Listed; File E227626; Category NWIN (US), NWIN7 (Canada) – Information Technology and Communications Equipment Cabinet, Enclosure and Rack
- Each rack will support up to 2200 lb (1000.0 kg) of equipment

### Rack Includes:

- (2) mounting frames
- (4) horizontal braces
- (2) front mounting rails
- (2) rear mounting rails
- (1) top-mount cable tray
- Assembly hardware: (1) Two Mounting Hole Ground Terminal Block and Antioxidant Joint Compound
- ARSR includes (50) #12-24 cage nuts and screws
- ARQR includes (50) #12-24 screws



Mounting Rails can be flipped to change numbering from bottom-to-top or top-to-bottom

# ADJUSTABLE RAIL 4-POST RACK

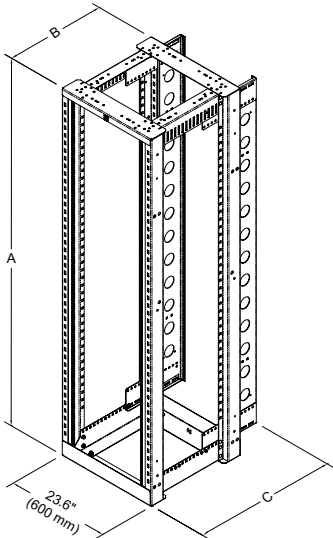

Adjustable Rail QuadraRack® and Adjustable Rail ServerRack	
1525	19" Adjustable Rail 4-Post Racks

	Mounting Hole Style	Rack Depth (B) in (mm)	Max. Rail Depth (C) in (mm)
1	#12-24 Threaded	23.62 (600)	29.52 (750)
2	#12-24 Threaded	35.43 (900)	41.33 (1050)
3	Square-Punched	23.62 (600)	29.52 (750)
4	Square-Punched	35.43 (900)	41.33 (1050)

Note: Min. Rail Depth is 15" (380 mm).

Color	
1	Gray
2	Computer Beige
7	Black
E	Glacier White

Height (A)		
	U	Height - in (mm)
01	38	72 (1800)
03	45	84 (2100)
15	51	96 (2400)

1525	X	-	X	XX
------	---	---	---	----

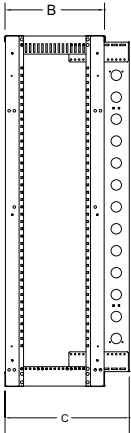

SIDE VIEW  
MAX. RAIL DEPTH

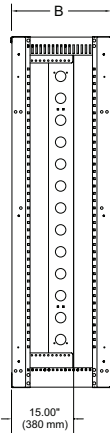

SIDE VIEW  
MIN. RAIL DEPTH

# ADJUSTABLE RAIL 4-POST RACK ACCESSORIES



15285-X01



15275-X01



15286-001



15270-X01



15260-X01

Mounting Rails can be flipped to change numbering from bottom-to-top or top-to-bottom

## Adjustable Rail 4-Post Rack Accessories

### Equipment Support Rail

Attaches to the side of the Adjustable Rail QuadraRack or ServerRack and provides a .98" W (25 mm) support surface for equipment. Does not interfere with rack-mount unit (U) spaces. Supports 200 lb (90.7 kg) of equipment and includes hardware.

### Top-Mount Cable Waterfall Tray

One Top-Mount Cable Waterfall Tray is included with each rack to guide patch cords side-to-side or rack-to-rack. 6" W x 5.2" D (152 mm x 132 mm) steel tray.

### Cable Guide Kit

T-shaped cable guides (7U) snap-on to the front or rear of the rack to organize cables. The openings align with each rack-mount unit on the rack.

### Side Panel

Solid, steel side panel used to cover the end of the rack and/or vertical cable managers at the end of a row. Matches the height and depth of rack, steel.

### Fixed Equipment Mounting Rail

Additional pair of equipment mounting rails to create a solution with two mounting depths set between 15" D (381 mm) and the rack depth. Includes installation hardware.

Part Number	Description	Shipping Weight lb (kg)
15285-X01	Equipment Rail, for 23.62" (600 mm) Racks	7 (3.2)
15285-X02	Equipment Rail, for 35.43" (900 mm) Racks	11 (5.0)
15275-X01	Top-Mount Cable Waterfall Tray	14 (6.4)
15286-001	Cable Guide, for 38U Racks, Black	5 (2.3)
15286-003	Cable Guide, for 45U Racks, Black	6 (2.7)
15286-015	Cable Guide, for 51U Racks, Black	7 (3.2)
15270-X01	Side Panel, 23.62"D x 72"H	51 (23.1)
15270-X02	Side Panel, 23.62"D x 84"H	57 (25.9)
15270-X03	Side Panel, 23.62"D x 96"H	48 (21.8)
15270-X04	Side Panel, 35.43"D x 72"H	63 (28.6)
15270-X05	Side Panel, 35.43"D x 84"H	71 (32.2)
15270-X06	Side Panel, 35.43"D x 96"H	60 (27.2)
15259-X01	Fixed Rail, Threaded, for 38U Racks	20 (9.1)
15259-X03	Fixed Rail, Threaded, for 45U Racks	23 (10.4)
15259-X15	Fixed Rail, Threaded, for 51U Racks	26 (11.8)
15260-X01	Fixed Rail, Square-Punched, for 38U Racks	19 (8.6)
15260-X03	Fixed Rail, Square-Punched, for 45U Racks	22 (10.0)
15260-X15	Fixed Rail, Square-Punched, for 51U Racks	25 (11.3)

X=Color; 1=Gray, 2=Computer Beige, 7=Black, E=Glacier White





## Adjustable QuadraRack® (AQR) and ServerRack (ASR)

The Adjustable QuadraRack® and the Adjustable ServerRack provide a sturdy, cost-effective solution for supporting rack-mount network, computer server and data storage equipment in data centers, computer equipment rooms and other IT facilities. Both racks offer the strength and stability of an enclosure in an open four-post frame that provides easy access to equipment and cabling.

Each rack will support up to 2000 lb (907.2 kg) of equipment. The corner posts are C-shaped equipment mounting channels that provide front and rear support for 19"W rack-mount equipment or shelves. The front and rear frames are welded to reduce assembly time. Four brackets connect the front and rear corners of the rack. The rack is available in four heights and four depth ranges. The front-to-rear depth of the mounting channels can be adjusted up to 5.91" (150 mm) in depth in .98" (25 mm) increments during assembly. The mounting channels are fixed in place once assembled to surround and protect equipment.

The Adjustable QuadraRack has threaded mounting holes that make installation time of patch panels, fiber enclosures and network switches shorter. Adjustable ServerRack has square-punched holes that let you change mounting hardware (cage nuts) to match specific computer server and data storage equipment mounting requirements. Each rack-mount unit is marked on the channels, making it easy to locate and position equipment. A second set of holes along the sides of the channels lets you add optional side-mounted Equipment Support Rails that use no additional rack-mount space.

### Features:

- Open design for unrestricted airflow and easy access to equipment and cabling
- Self-squaring assembly with welded front and rear frames reduces assembly time
- Mounting channels adjust in depth to provide front and rear support for equipment
- Maximizes floor space with a minimal rack footprint
- Rack components are bonded together during assembly
- Includes a Two Mounting Hole Ground Terminal Block for easy attachment to the Telecommunications Grounding Busbar
- Choose square-punched or threaded equipment mounting holes
- Rack-mount unit spaces are marked on the mounting channels
- Easy to bay together to create multi-rack configurations
- Use with any CPI Cabling Section to manage cables
- Support large equipment on heavy-duty shelves or on side-mounted Equipment Support Rails
- UL Listed; File E227626; Category NWIN (US), NWIN7 (Canada) – Information Technology and Communications Equipment Cabinet, Enclosure and Rack
- Supports 2000 lb (907.2 kg) of equipment

# ADJUSTABLE 4-POST RACK

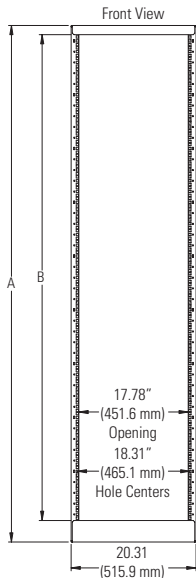

Side View

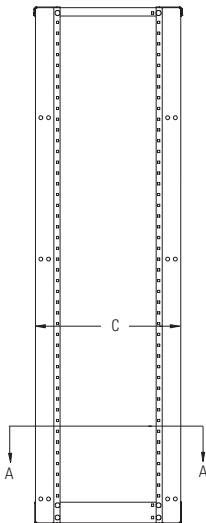

Adjustable QuadraRack® and ServerRack, 19"	
1521	19" Adjustable 4-Post Racks

	Mounting Hole Style	Mounting Channel Depth Range (C) in (mm)
1	Square-Punched	15.75 to 21.65 (400 to 550)
2	Square-Punched	22.64 to 28.54 (575 to 725)
3	Square-Punched	29.53 to 35.43 (750 to 900)
4	Square-Punched	36.42 to 42.32 (925 to 1075)
5	#12-24 Threaded	15.75 to 21.65 (400 to 550)
6	#12-24 Threaded	22.64 to 28.54 (575 to 725)
7	#12-24 Threaded	29.53 to 35.43 (750 to 900)
8	#12-24 Threaded	36.42 to 42.32 (925 to 1075)

Color	
1	Gray
2	Computer Beige
7	Black
E	Glacier White

Height (A)			
	U	(A) - in (mm)	(B) - in (mm)
01	38	72 (1800)	67 (1700)
03	45	84 (2100)	79 (2000)
15	51	96 (2400)	91 (2300)
08	58	108 (2740)	103 (2620)

1521	X	-	X	XX
------	---	---	---	----

Note: Mounting channel depth adjusts in .98" (25 mm) increments during assembly. The mounting depth is fixed once the rack is assembled. See the table on next page for a list of mounting channel depth settings by part number.

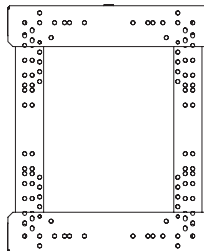

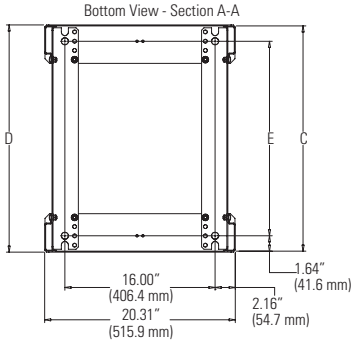

**Notes:**

1. There are seven depth settings for each part number as listed in the table.
2. Each rack adjusts front-to-rear in depth up to 5.91" (150 mm) in .98" (25 mm) increments.
3. Rack mounting channel depth is fixed once assembled.
4. Overall Depth (D) is Channel Depth (C) + 21" (53 mm).
5. Floor Mounting Holes (E) are Channel Depth (C) - 3.28" (83.3 mm).

Mounting Channel Depth Settings and Dimensions by Part Number							
Part Numbers		Channel Depth (C)		Overall Depth (D)		Floor Mounting Holes (E)	
		in	mm	in	mm	in	mm
15215-XXX	15211-XXX	15.75	400	15.96	405.4	12.47	316.7
		16.73	425	16.94	430.3	13.45	341.6
		17.72	450	17.93	455.4	14.44	366.8
		18.70	475	18.91	480.3	15.42	391.7
		19.69	500	19.90	505.5	16.41	416.8
		20.67	525	20.88	530.4	17.39	441.7
		21.65	550	21.86	555.2	18.37	466.6
15216-XXX	15212-XXX	22.64	575	22.85	580.4	19.36	491.7
		23.62	600	23.83	605.3	20.34	516.6
		24.61	625	24.82	630.4	21.33	541.8
		25.59	650	25.80	655.3	22.31	566.7
		26.57	675	26.78	680.2	23.29	591.6
		27.56	700	27.77	705.4	24.28	616.7
		28.54	725	28.75	730.3	25.26	641.6
15217-XXX	15213-XXX	29.53	750	29.74	755.4	26.25	666.8
		30.51	775	30.72	780.3	27.23	691.6
		31.50	800	31.71	805.4	28.22	716.8
		32.48	825	32.69	830.3	29.2	741.7
		33.46	850	33.67	855.2	30.18	766.6
		34.45	875	34.66	880.4	31.17	791.7
		35.43	900	35.64	905.3	32.15	816.6
15218-XXX	15214-XXX	36.42	925	36.63	930.4	33.14	841.8
		37.40	950	37.61	955.3	34.12	866.6
		38.39	975	38.60	980.4	35.11	891.8
		39.37	1000	39.58	1005	36.09	916.7
		40.35	1025	40.56	1030	37.07	941.6
		41.34	1050	41.55	1055	38.06	966.7
		42.32	1075	42.53	1080	39.04	991.6

## Solid and Vented Shelves

1U x 19"W steel, shelf with adjustable depth rear mounting brackets; 17.68"W (449.1 mm). Supports 200 lb (90.7 kg) of equipment; includes assembly hardware.



Part Number	Shelf Depth in (mm)	Mounting Channel Depth in (mm)	Shipping Weight lb (kg)
<b>Solid Shelves</b>			
15245-X01	13.84 (351.5)	15.75 to 21.65 (400 to 550)	10 (4.5)
15245-X02	20.73 (526.5)	22.64 to 28.54 (575 to 725)	12 (5.4)
15245-X03	27.62 (701.6)	29.53 to 35.43 (750 to 900)	15 (6.8)
15245-X04	34.51 (876.6)	36.42 to 42.32 (925 to 1075)	18 (8.2)
<b>Vented Shelves</b>			
15255-X01	13.84 (351.5)	15.75 to 21.65 (400 to 550)	10 (4.5)
15255-X02	20.73 (526.5)	22.64 to 28.54 (575 to 725)	12 (5.4)
15255-X03	27.62 (701.6)	29.53 to 35.43 (750 to 900)	15 (6.8)
15255-X04	34.51 (876.6)	36.42 to 42.32 (925 to 1075)	18 (8.2)

X=Color; 1=Gray, 2=Computer Beige, 7=Black, E=Glacier White



15235-X01



12700-X19



15205-X01



15330-X01



15335-X01

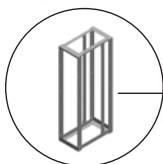

## Adjustable 4-Post Rack Accessories

### Equipment Support Rail

Additional support for heavy rack-mount equipment. Attaches to the side of rack and provides a 1.5"W (38 mm) front-to-rear support surface for equipment. Supports 200 lb (90.7 kg) of equipment; includes hardware.

### Extra Heavy Duty Sliding Shelf

This 2U x 19"W sliding shelf with adjustable depth rear mounting brackets attaches to rack channels set 20.62" to 32.48"D (525 to 825 mm). Solid surface is 15.5"W x 26"D (393.7 mm x 660 mm), extends 24" (609 mm) and locks in the open and closed positions. Supports 300 lb (136 kg) of equipment.

### Cable Runway Mounting Bracket

Aligns with the front, rear or side of the rack and supports 6"W to 24"W (150 mm to 600 mm) CPI Cable Runway. S-shaped, steel bracket measures 1.0"H x 3.3"W x 24.4"L (25 mm x 84 mm x 620 mm) and includes mounting hardware.

### Center Rail

Attach the rails at any point along the side of the rack for adjustable depth. Marked and numbered rack-mount spaces simplify equipment installation. Maximum mount depth is 6" (152 mm) less than the channel depth of the rack. 1000 lb (453.6) equipment load bearing capacity when used as an independent pair or rails; rack load remains 2000 lb (907.2) when Center Rail is used as the front or rear pair of four-point mounting solution.

Part Number	Description	Shipping Weight lb (kg)
15235-X01	Equipment Rail, 15.75 to 19.69 (400 to 500) D	5 (2.3)
15235-X02	Equipment Rail, 20.67 to 24.61 (525 to 625) D	6 (2.7)
15235-X03	Equipment Rail, 25.59 to 29.53 (650 to	7 (3.2)
15235-X04	Equipment Rail, 30.51 to 34.45 (775 to	9 (4.1)
15235-X05	Equipment Rail, 35.43 to 39.37 (900 to	10 (4.5)
15235-X06	Equipment Rail, 40.35 to 44.29 (1025	12 (5.4)
12700-X19	Extra Heavy Duty Solid Shelf, 19"W	51 (23.1)
15275-X01	Top-Mount Cable Waterfall Tray	14 (6.4)
15330-X01	Center Rail, Square Punched, 38U, 72	20 (9.1)
15330-X03	Center Rail, Square Punched, 45U, 84	23 (10.4)
15330-X15	Center Rail, Square Punched, 51U, 96	26 (11.8)
15330-X08	Center Rail, Square Punched, 58U, 108	29 (13.2)
15335-X01	Center Rail, Threaded #12-24, 38U, 72	20 (9.1)
15335-X03	Center Rail, Threaded #12-24, 45U, 84	23 (10.4)
15335-X15	Center Rail, Threaded #12-24, 51U, 96	26 (11.8)
15335-X08	Center Rail, Threaded #12-24, 58U, 108	29 (13.2)
15205-X01	Cable Runway Mounting Bracket, for 6 to 24 (150 to 600) W Cable Runway	5 (2.3)

X=Color; 1=Gray, 2=Computer Beige, 7=Black, E=Glacier White

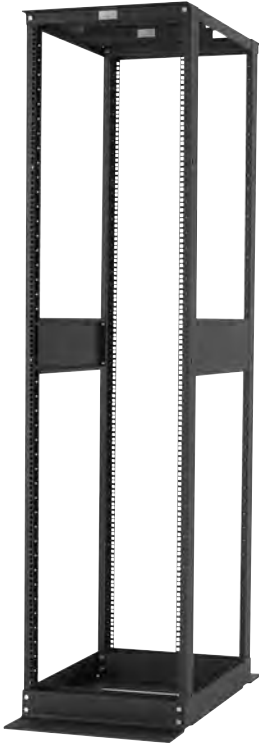

## QuadraRack® Server Frame

Designed specifically for rack-mount servers, the QuadraRack® Server Frame offers the strength and stability of a cabinet, but in an open mounting system. Providing easy access for simplified installation and cabling, the QuadraRack Server Frame offers unrestricted airflow for improved cooling and heat dissipation. The unique, steel C-shaped channels with square holes and horizontal braces, were designed to provide optimal torsional strength. The horizontal braces are quick and easy to install with the supplied carriage bolts. Since rack-mount servers require various types of mounting screws, cage nuts provide the flexibility.

- 19" EIA width
- Manufactured from aluminum and steel
- Available in powder coat color finishes: Gray, Computer Beige, Black or Glacier White
- EIA-310-D Standard Universal 5/8"-5/8"-1/2" (15.9 mm-15.9 mm-12.7 mm) alternating hole pattern
- Square-punched mounting holes adapt with cage nuts (listed below) to match equipment mounting requirements
- Top Extension Pan Set provides two 6" x 16" (150 mm x 410 mm) cable access ports
- Frame depth is 29" (740 mm) with overall depth of 41" (1040 mm) from edge-to-edge of base angles
- Load Rating: 1000 lb (453.6 kg) — weight must be evenly distributed, and rack must be properly secured to the floor

### QuadraRack Server Frame Kit includes:

- (4) Rack Channels
- (2) Base Angles
- (2) Top Angles

Part Number	Description	Shipping Weight lb (kg)
15053-X03	7 (2.1) x 19 x 29 (740), 45U	77 (34.9)

*X=Color; 1=Gray, 2=Computer Beige, 7=Black, E=Glacier White*



Steel Channels with square holes adapt to server mounting screws

### Square-Punched Hardware Kits (sold separately)

Part Number	Nominal Size	Package Of	Finish	Shipping Weight lb (kg)
12637-001	M-6	25	Gold Over Zinc	1 (0.5)
12638-001	10-32	25	Zinc	1 (0.5)
12639-001	12-24	25	Black	1 (0.5)

# FIXED 4-POST RACK



Not intended for rack-mount servers

## QuadraRack® 4-Post Frame

The QuadraRack® 4-Post Frame offers the strength and stability of a cabinet in an open mounting system. Enjoy easy equipment installation, along with unrestricted airflow for improved cooling and heat dissipation.

- 19" EIA width
- Manufactured from aluminum
- EIA-310-D Standard Universal 5/8"-5/8"-1/2" (15.9 mm-15.9 mm-12.7 mm) alternating hole pattern, mounting holes are roll-formed #12-24
- Ships unassembled
- Load Rating: 2000 lb (907.2 kg) — weight must be evenly distributed, and rack must be properly secured to the floor

### QuadraRack 4-Post Frame Kit includes:

- (4) Rack Channels
- (2) Base Angles
- (2) Top Angles
- (1) Extension Pan Set
- (1) Bag of 100 Rack mounting screws — Pilot Point #12-24 with combination Phillips/Straight head

Part Number	Description H x W x D Height - ft (m), Depth - in (mm)	Shipping Weight lb (kg)
50120-X03	7 (2.1) x 19 x 29 (740), 45U	65 (29.5)
50120-X15	8 (2.4) x 19 x 29 (740), 51U	67 (30.4)
50120-X08	9 (2.7) x 19 x 29 (740), 58U	69 (31.3)

X=color: 1=Gray, 2=Computer Beige, 5=Clear, 7=Black, E=Glacier White

## ExpandaRack

Convert a CPI two-post rack to a QuadraRack with ExpandaRack.



Part Number	Description H x W x D Height - ft (m), Depth - in (mm)	Shipping Weight lb (kg)
<b>ExpandaRack - Standard Rack</b>		
50110-X03	7 (2.1) x 19 x 29 (740), 45U	46 (20.9)
50110-X15	8 (2.4) x 19 x 29 (740), 51U	48 (21.8)
50110-X08	9 (2.7) x 19 x 29 (740), 58U	50 (22.7)
<b>ExpandaRack - Universal Rack</b>		
50130-X03	7 (2.1) x 19 x 29 (740), 45U	52 (23.6)
50130-X15	8 (2.4) x 19 x 29 (740), 51U	55 (24.9)
50130-X08	9 (2.7) x 19 x 29 (740), 58U	58 (26.3)
<b>ExpandaRack - Pan Set (W x D)</b>		
50150-X99	19 x 29 (740) — Standard Rack	18 (8.2)
50160-X99	19 x 29 (740) — Universal Rack	18 (8.2)

X=color: 1=Gray, 2=Computer Beige, 5=Clear, 7=Black, E=Glacier White

1U



16351-X19

1U



16350-X19

2U

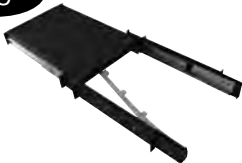

12700-X19

3U



16356-X19



16341-X19

## QuadraRack® Accessories

### Heavy Duty Fixed Shelf - Solid

Specially designed for QuadraRack. 1U x 19"W x 29"D (740 mm) shelf. Supports up to 200 lb (90.7 kg).

### Heavy Duty Fixed Shelf - Vented

Specially designed for QuadraRack. 1U x 19"W x 29"D (740 mm) vented shelf that optimizes airflow. Supports up to 200 lb (90.7 kg).

### Extra Heavy Duty 4-Point Sliding Shelf

Specially designed to support heavy equipment. 2U x 19"W x 26"D (660 mm) sliding shelf, extends 24" (610 mm), adjusts between 20" and 34" (510 mm and 860 mm) mounting depth. Supports up to 300 lb (136.1 kg).

### Equipment Tie-Down Bracket

Prevents back-and-forth, side-to-side and up-and-down movement of shelf-mount equipment. 3U x 19"W x 23"D (580 mm).

### Dust Cover

Improves the appearance of QuadraRack 4-Post Frame and prevents the accumulation of dust and debris at the base.

### Power Strips

Both horizontal and vertical power strips can be mounted to the QuadraRack. These solutions can be found in Section 7.

Part Number	Description	Shipping Weight lb (kg)
16351-X19	Heavy Duty Fixed Shelf, Solid	11 (5.0)
16350-X19	Heavy Duty Fixed Shelf, Vented	11 (5.0)
12700-X19*	Extra Heavy Duty Sliding Shelf*	8 (3.6)
16342-X01	Rack Line-Up Spacer, Universal	1 (0.5)
16342-X02	Rack Line-Up Spacer, Standard	1 (0.5)
16356-X19	Equipment Tie-Down Bracket	4 (1.8)
16341-X19	Rack Base Dust Cover	4 (1.8)

X=color: 1=Gray, 2=Computer Beige, 5=Clear, 7=Black, E=Glacier White

\*Not available in Clear.

1U

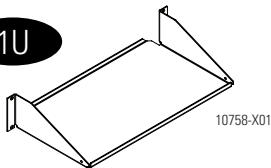

### Small Peripheral Shelf

Designed to hold small peripheral equipment in a central location. Each shelf typically holds two units and allows a convenient cable run down the inside of the rack channel. Mounting hardware not included. 19" rack mountable, holds equipment up to 17.35"W x 9.82"D (440.7 mm x 249.4 mm). Made of strong, lightweight aluminum; supports up to 50 lb (22.7 kg).

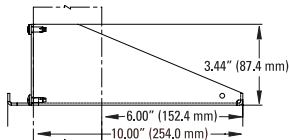

3U

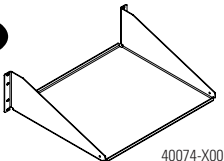

### Single-Sided Shelf

A convenient 15"D (380 mm) mounting shelf for miscellaneous equipment, test gear, etc. Mounting hardware not included. 19" version holds equipment up to 17.25"W x 14.82"D (438.2 mm x 376.4 mm), 23" version holds equipment up to 21.25"W x 14.82"D (539.8 mm x 376.4 mm). Made of strong, lightweight aluminum; supports up to 50 lb (22.7 kg). 19" version is UL Listed: File E140851; Category DUXR (US), DUXR7 (Canada) – Communications Circuit Accessory.

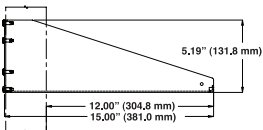

### Single-Sided Vented Shelf

Supports routers, switches, CPUs or any equipment requiring bottom ventilation. Mounting hardware not included. 19" version holds equipment up to 17.25"W x 14.82"D (438.2 mm x 376.4 mm), 23" version holds equipment up to 21.25"W x 14.82"D (539.8 mm x 376.4 mm). Wall, backboard or rack mountable. Made of strong, lightweight aluminum with airflow perforations; supports up to 50 lb (22.7 kg).

3U

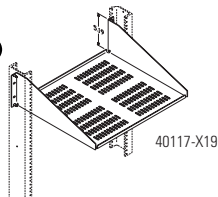

### 16"D (410 mm) Low-Profile Shelf

Reduced height design saves on valuable rack space. Center mount design is ideal for single sided racks, mounts to either front or back of rack channel face. Mounting hardware not included. 19"W version holds equipment up to 17.25"W x 15.82"D (438.2 mm x 401.8 mm), 23"W version holds equipment up to 21.25"W x 15.82"D (539.8 mm x 401.8 mm). Made of strong, lightweight aluminum; supports up to 40 lb (18.1 kg).

2U

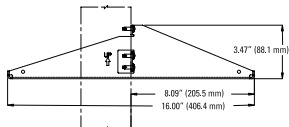
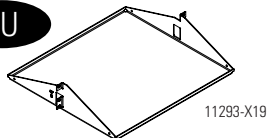

Part Number	Description	Shipping Weight lb (kg)
10758-X01	Small Peripheral Shelf, 19"W	5 (2.3)
40074-X00	Single-Sided Shelf, For 19" Rack	6 (2.7)
40075-X00	Single-Sided Shelf, For 23" Rack	7 (3.2)
40117-X19	Single-Sided Vented Shelf, For 19" Rack	6 (2.7)
40118-X23	Single-Sided Vented Shelf, For 23" Rack	7 (3.2)
11293-X19	Low-Profile Shelf, For 19" Rack	4 (1.8)
11293-X23	Low-Profile Shelf, For 23" Rack	5 (2.3)

X=Color: 1=Gray, 2=Computer Beige, 5=Clear, 7=Black, E=Glacier White



3U

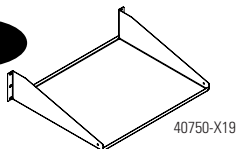

40750-X19

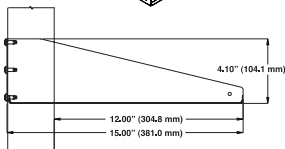

3U

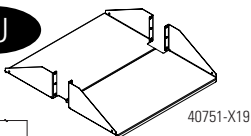

40751-X19

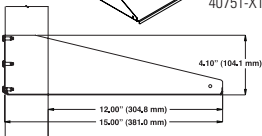

2U

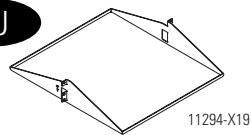

11294-X19

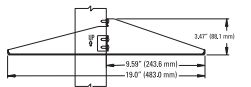

5U

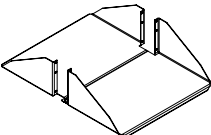

11054-X19

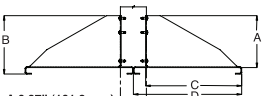

A 6.37" (161.8 mm)  
 B 7.16" (181.9 mm)  
 C 11.53" (292.9 mm)  
 D 13.00" (330.2 mm)

## Standard Single-Sided Steel Shelf

Economical rack or wall-mounted shelf for miscellaneous equipment. Made of cold-rolled steel and may be rack or wall-mounted. 19" rack-mountable, holds equipment up to 17.25"W x 14.75"D (438.2 mm x 374.7 mm). Sold two per shipping carton; supports up to 35 lb (15.9 kg).

## Standard Double-Sided Steel Shelf

An economical rack or wall-mounted shelf with twice the shelf space for centered loading and deeper equipment handling. Made of cold-rolled steel, this shelf mounts on double-sided racks only. 19"W rack-mountable, holds equipment up to 17.25"W x 21.50"D (438.2 mm x 546.1 mm) and supports up to 25 lb (11.3 kg) per side or 50 lb (22.7 kg) total.

## 19"D (480 mm) Low-Profile Shelf

Reduced height design saves on valuable rack space. Mounts to either front or back of rack channel face. Mounting hardware not included. 19" version holds equipment up to 17.25"W x 18.82"D (438.2 mm x 478.0 mm), 23" version holds equipment up to 21.25"W x 18.82"D (539.8 mm x 478.0 mm). Made of strong, lightweight aluminum; supports up to 40 lb (18.1 kg).

## 26"D (660 mm) Shelf

Extra deep design is convenient for mounting large equipment requiring additional support. Will fit inside most CPI rack enclosures, except P/N 11058 or wall enclosure. Mounting hardware not included. 19" version holds equipment up to 17.75"W x 25.8"D (450.9 mm x 655.8 mm), 23" version holds equipment up to 21.75"W x 25.8"D (552.5 mm x 655.8 mm). Made of strong, lightweight aluminum; supports up to 150 lb (68.0 kg). 19" version is UL Listed: File E140851; Category DUXR (US), DUXR7 (Canada) – Communications Circuit Accessory.

Part Number	Description	Shipping Weight lb (kg)
40750-X19*	Standard Single-Sided Steel Shelf, Black	12 (5.4)
40751-X19*	Standard Double-Sided Steel Shelf, Black	10 (4.5)
11294-X19	Low Profile Shelf, For 19" Rack	5 (2.3)
11294-X23	Low Profile Shelf, For 23" Rack	6 (2.7)
11054-X19	26"D (660 mm) Shelf, For 19" Rack	10 (4.5)
11054-X23	26"D (660 mm) Shelf, For 23" Rack	10 (4.5)

X=color: 1=Gray, 2=Computer Beige, 5=Clear, 7=Black, E=Glacier White

\*Shelves are not available in clear finish.



4U

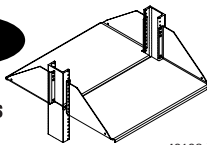

40108-X19

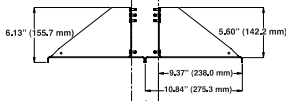

4U

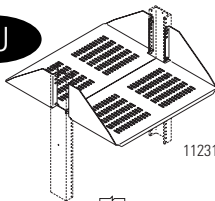

11231-X19

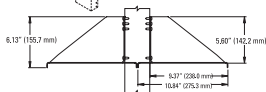

2U

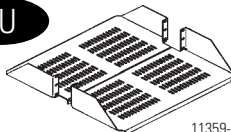

11359-X19

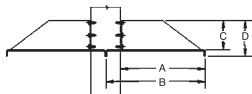

- A 8.53" (216.7 mm)
- B 10.0" (254.0 mm)
- C 2.91" (73.9 mm)
- D 3.53" (89.7 mm)

## Double-Sided Shelf

Provides centered loading for deeper and heavier equipment. Mounts on 3"D (80 mm) double-sided racks only. Mounting hardware not included. 19" version holds equipment up to 17.75"W x 21.5"D (450.9 mm x 546.0 mm), 23" version holds equipment up to 21.75"W x 21.5"D (552.5 mm x 546.0 mm). Made of strong, lightweight aluminum; supports up to 100 lb (45.4 kg). 19" version is UL Listed: File E140851; Category DUXR (US), DUXR7 (Canada) – Communications Circuit Accessory.

## Double-Sided Vented Shelf

Convenient for mounting any equipment requiring bottom ventilation, airflow perforations for increased airflow around components. Mounting hardware not included. 19" version holds equipment up to 17.75"W x 21.5"D (450.9 mm x 546.0 mm), 23" version holds equipment up to 21.75"W x 21.5"D (552.5 mm x 546.0 mm). Made of strong, lightweight aluminum; supports up to 100 lb (45.4 kg).

## Double-Sided Low-Profile Vented Shelf

Reduced height design saves valuable rack space and perforated shelf keeps equipment cool, includes bottom ventilation for enhanced airflow circulation. Mounting hardware not included. 19" version holds equipment up to 17.75"W x 19.8"D (450.9 mm x 503.4 mm). Mounts on 3"D (80 mm) double-sided racks only. Made of strong, lightweight aluminum; supports up to 60 lb (27.2 kg).

Part Number	Description	Shipping Weight lb (kg)
40108-X19	Double-Side Shelf, For 19" Rack	8 (3.6)
40108-X23	Double-Side Shelf, For 23" Rack	9 (4.1)
11231-X19	Double-Side Vented Shelf, For 19" Rack	8 (3.6)
11232-X23	Double-Side Vented Shelf, For 23" Rack	9 (4.1)
11359-X19	Low-Profile Vented Shelf For 19" Rack	8 (3.6)
11359-X23	Low-Profile Vented Shelf For 23" Rack	9 (4.1)

X=color: 1=Gray, 2=Computer Beige, 5=Clear, 7=Black, E=Glacier White

5U

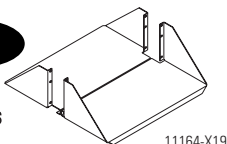

11164-X19

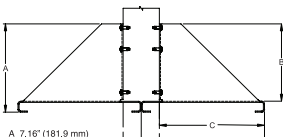

A: 7.16" (181.9 mm)

5U

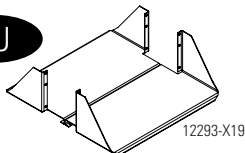

12293-X19

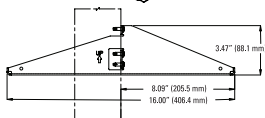

8.89" (225.5 mm)  
16.00" (406.4 mm)

3.47" (88.1 mm)

4U

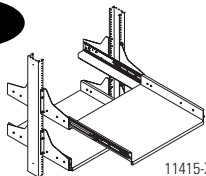

11415-X19

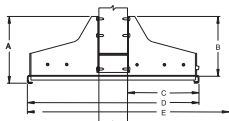

A: 7.00" (177.8 mm)  
B: 8.20" (208.3 mm)  
C: 7.46" (190.0 mm)  
D: 18.0" (457.2 mm)  
E: 28.42" (722.3 mm)

4U

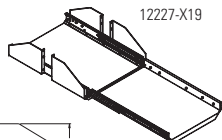

12227-X19

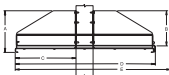

A: 7.25" (184.3 mm)  
B: 8.16" (207.6 mm)  
C: 10.00" (254.0 mm)  
D: 24.25" (615.9 mm)  
E: 46.00" (1168.3 mm)

## Heavy Duty Equipment Shelf for 3" (80 mm) Channel

Convenient for mounting large equipment requiring additional support. Mounting hardware not included. 19" version holds equipment up to 17.75"W x 19.8"D (450.9 mm x 503.4 mm). 23" version holds equipment up to 21.75"W x 19.8"D (552.5 mm x 503.4 mm). Made of strong, lightweight aluminum; supports up to 200 lb (90.7 kg). 19" version is UL Listed: File E140851; Category DUXR (US), DUXR7 (Canada) – Communications Circuit Accessory.

## Heavy Duty Equipment Shelf for 6" (150 mm) Channel

This shelf is designed to hold heavy equipment requiring extra support. Fits Standard Rack 6"D (150 mm) and Seismic Frame® Two Post Rack. Mounting hardware not included. 19" version holds equipment up to 17.75"W x 19.8"D (450.9 mm x 503.4 mm). Made of strong, lightweight aluminum; supports up to 200 lb (90.7 kg).

## Sliding Equipment Shelf

Provides a sliding shelf for front access to all equipment. Mounting hardware not included. 18"D (460 mm) shelf extends out an additional 16" (410 mm) from closed position. Lockable in fully extended and fully retracted positions. 19" version holds up to 16"W x 17.5"D (410 mm x 445 mm) equipment, 23" version holds up to 20"W x 17.5"D (510 mm x 445 mm) equipment. Mounts on 3"D (80 mm) double-sided racks only. Made of sturdy, lightweight aluminum; supports up to 100 lb (45.4 kg).

## Extra-Extended Sliding Equipment Shelf

Provides a full 25" (640 mm) extension. It is easy to access the back of network servers (or other large equipment). Mounting hardware not included. 19" holds up to 16"W x 24"D (410 mm x 610 mm) equipment, 23" holds up to 20"W x 24"D (510 mm x 610 mm) equipment. Shelf locks in closed or fully open position, and ships fully assembled. Strong, lightweight aluminum construction; supports up to 150 lb (68 kg).

*Note: To prevent tipping, rack must be properly attached to floor.*

Part Number	Description	Shipping Weight lb (kg)
11164-X19	Heavy Duty Shelf for 3" (80 mm) Channel, For 19" Rack	8 (3.6)
11164-X23	Heavy Duty Shelf for 3" (80 mm) Channel, For 23" Rack	9 (4.1)
12293-X19	Heavy Duty Shelf for 6" (150 mm) Channel, For 19" Rack	10 (4.5)
11415-X19	Sliding Equipment Shelf, For 19" Rack	13 (5.9)
11415-X23	Sliding Equipment Shelf, For 23 Rack	13 (5.9)
12227-X19	Extra-Extended Shelf, For 19" Rack	10 (4.5)
12227-X23	Extra-Extended Shelf, For 23 Rack	10 (4.5)

X=color: 1=Gray, 2=Computer Beige, 5=Clear, 7=Black, E=Glacier White

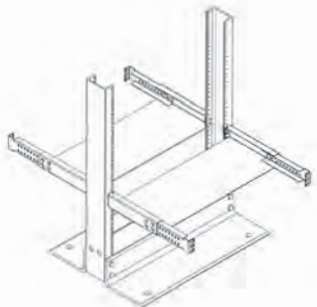

A split-pan design provides a broader surface area to support server weight

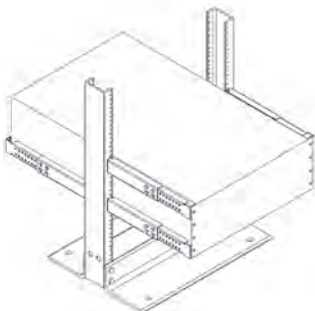

anyServer Bracket shown on rack with server and optional Server Support Arms

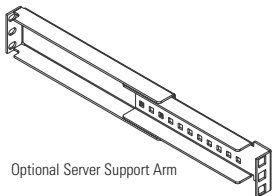

Optional Server Support Arm

## anyServer Bracket

The anyServer Bracket is a simple, yet sturdy solution to secure virtually any server to a 19"W, two-post open rack. It is the ideal, cost-effective system for retrofitting existing racks to accommodate one or more servers, instead of reverting to a four-post rack or cabinet system. The anyServer Bracket can be adjusted to fit all of your server's requirements, enabling you to keep the same mounting system, even if you change equipment in the future.

Purchase optional Supplementary Server Support Arms to firmly secure the tops of tall servers to the rack. In some instances, they can also help you mount your server if its captive screw holes are in the middle or top of the device.

The anyServer Bracket comes with front and rear steel pans and four steel adjustable arms (with mounting hardware).

- Manufactured from cold rolled steel
- The server can be positioned 9" to 13" (230 mm to 330 mm) in front of the rack channel; mounting arms extend 4" (100 mm) total in .5" (10 mm) increments
- Square holes at the front of adjustable mounting arms for cage nuts (sold separately)
- Acorn nuts eliminate sharp edges
- Supplementary arms (purchased separately) provide extra support
- Load rating:
  - 1U bracket is 80 lb (36.3 kg)
  - 2U bracket is 120 lb (54.4 kg)
- Rack mounting hardware is not included

Part Number	Description H x W (in)	Shipping Weight lb (kg)
12751-719	1U x 19, Black Bracket	11 (5.0)
12752-719	2U x 19, Black Bracket	14 (6.4)
12759-701	Supplementary Server Support Arms, Fixed, 1 Pair, 1U, Black	3 (1.4)

Square-Punched Hardware Kits (sold separately)				
Part Number	Nominal Size	Package Of	Finish	Shipping Weight lb (kg)
12637-001	M-6	25	Gold Over Zinc	1 (0.5)
12638-001	10-32	25	Zinc	1 (0.5)
12639-001	12-24	25	Black	1 (0.5)

### Redesigned to allow stackable units



Drawer with two-post mounting brackets



Drawer with four-post mounting brackets



## Lockable Storage Drawer

CPI's improved Lockable Storage Drawer keeps backup media, software, manuals, laptops, test equipment and extra patch cords in close proximity to where they are typically used within a rack or cabinet.

Lockable Storage Drawer is available for 19"W or 23"W racks and cabinets. It includes attachment brackets that allow center mounting on two-post racks with 3" or 6"D (80 mm or 150 mm) equipment channels, or front and rear attachment to four-post racks and cabinet systems with mounting rails that are adjusted between 24" and 39"D (610 mm and 990 mm).

- Attaches to any CPI freestanding 19"W or 23"W rack or cabinet system
- Available in three heights: 2U, 3U and 4U
- Features 20"D (510 mm) lockable drawer that extends full-depth for easy access to stored equipment
- Redesigned to allow for stackable units
- Supports a 100 lb (45.4 kg) load (drawer and top surface combined)

Part Number	Description	Shipping Weight lb (kg)
<b>19" Rack or Cabinet Mount Depth - in (mm)</b>		
13082-X19	2U Drawer, 20 (510)	18 (8.2)
13083-X19	3U Drawer, 20 (510)	20 (9.1)
13084-X19	4U Drawer, 20 (510)	22 (10.0)
<b>23" Rack or Cabinet Mount Depth - in (mm)</b>		
13082-X23	2U Drawer, 20 (510)	21 (9.5)
13083-X23	3U Drawer, 20 (510)	23 (10.4)
13084-X23	4U Drawer, 20 (510)	25 (11.3)

X=color: 1=Gray, 2=Computer Beige, 5=Clear, 7=Black, E=Glacier White

## Drawer Dividers For Lockable Storage Drawer

Divide your Lockable Storage Drawer into three sections, approximately 5"W (130 mm) each, to organize and store CD and tape cases. For use with the 3U and 4U drawers only.

Part Number	Description	Shipping Weight lb (kg)
13185-X01	Divider, 3U & 4U Drawers	3 (1.4)

X=color: 1=Gray, 2=Computer Beige, 5=Clear, 7=Black, E=Glacier White

# MONITOR/KEYBOARD TRAYS

6U

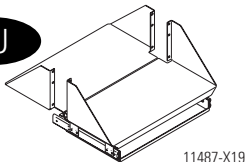

11487-X19

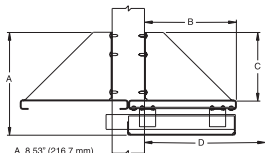

- A 8.53" (216.7 mm)
- B 9.64" (242.3 mm)
- C 6.37" (161.8 mm)
- D 17.12" (434.8 mm)

7U

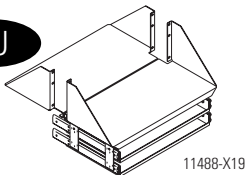

11488-X19

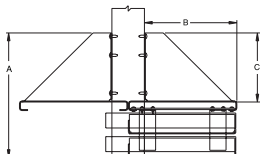

- A 11.49" (291.8 mm)
- B 8.53" (216.7 mm)
- C 6.37" (161.8 mm)
- D 17.12" (434.8 mm)

2U

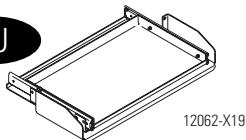

12062-X19

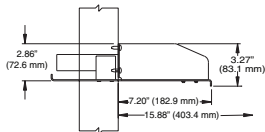

## CPU/Monitor Shelf with Single Sliding Keyboard Tray

Provides convenient mounting of CPU or monitor and keyboard. Mounting hardware not included. Keyboard tray extends 8.6" (218 mm), 19"W rack trays must use small footprint keyboard; maximum width 16.30" (414 mm). 19" holds equipment up to 17.75"W x 19.82"D (450.9 mm x 503.4 mm), 23" holds equipment up to 21.75"W x 19.82"D (552.5 mm x 503.4 mm). Made of strong, lightweight aluminum; supports up to 200 lb (90.7 kg).

*Note: Small footprint keyboards are available from CPI.*

## CPU/Monitor Shelf with Double Sliding Keyboard Tray

Convenient mounting two keyboards. Mounting hardware not included. The keyboard tray extends 8.6" (218 mm). 19"W rack trays must use small footprint keyboard; maximum width 16.30" (414 mm). 19" holds equipment up to 17.75"W x 19.82"D (450.9 mm x 503.4 mm), 23" holds equipment up to 21.75"W x 19.82"D (552.5 mm x 503.4 mm). Made of strong, lightweight aluminum; supports up to 200 lb (90.7 kg).

*Note: Small footprint keyboards are available from CPI.*

## Sliding Single Keyboard Tray

Provides retractable rack-mounting tray for keyboards up to 9.8"D (249 mm). Extends 8" (200 mm), providing full access to keyboard. Retracts out of the way when not in use. 19" version holds up to 16.1"W (409 mm) keyboards, 23" version holds up to 20.1"W (511 mm) keyboards. Mounting hardware not included. Made of strong, lightweight aluminum.

Part Number	Description	Shipping Weight lb (kg)
11487-X19	Monitor Shelf, Single Tray, For 19" Rack	12 (5.4)
11487-X23	Monitor Shelf, Single Tray, For 23" Rack	12 (5.4)
12487-X19	Monitor Shelf, Single Tray, For 19" Rack, with Mouse Pad Tray	12 (5.4)
12487-X23	Monitor Shelf, Single Tray, For 23" Rack, with Mouse Pad Tray	12 (5.4)
11488-X19	Monitor Shelf, Double Tray, For 19" Rack	16 (7.3)
11488-X23	Monitor Shelf, Double Tray, For 23" Rack	16 (7.3)
12062-X19*	Sliding Single Keyboard Tray, For 19" Rack	10 (4.5)
12062-X23	Sliding Single Keyboard Tray, For 23" Rack	10 (4.5)

X=color: 1=Gray, 2=Computer Beige, 5=Clear, 7=Black, E=Glacier White

\*Must use small footprint keyboard. Also available, Sliding Double Keyboard Tray (P/N 11227-XXX).

2U

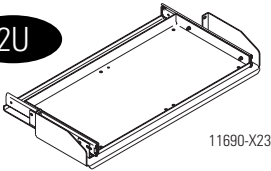

11690-X23

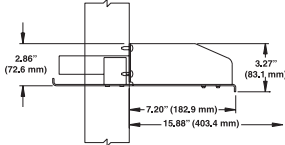

## 23" Full Size Sliding Keyboard Tray & Mouse

Convenient tray for holding keyboard and mouse. Mounting hardware not included. Keyboard tray extends 8" (200 mm) for full access to all keys. Tray and pad retract when not in use. Holds keyboards up to 20.1"W x 9.8"D (511 mm x 249 mm). 9" x 7" (230 mm x 180 mm) mouse pad mounts in a choice of four convenient locations. Made of strong, lightweight aluminum.

## Flush Mounted Sliding Keyboard Tray with Wrist Rest

Space-saving tray requires only 1U (44.45 mm), providing more space for mounting electronics. Ball bearing slides for smooth operation. Locks in open position, and retracts when not in use. 19" version holds up to 16.37"W x 7.67"D (415.8 mm x 194.8 mm) keyboards, 23" version holds up to 20.37"W x 8.67"D (517.4 mm x 220.2 mm) keyboards. Mounting hardware not included. Keyboard tray extends 11" (280 mm) for full access to all keys. Made of strong, lightweight aluminum.

1U

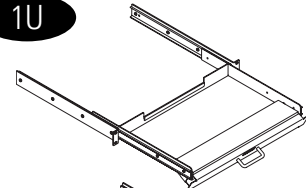

15555-X19

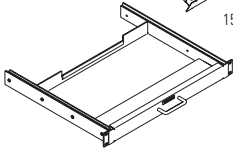

## Flush Mounted Keyboard Tray

Provides retractable rack-mounting tray for most keyboards up to 8.5"D (216 mm). Mounting hardware not included. Extends 8" (200 mm), giving full access to keyboard. Retracts when not in use. 19" version holds up to 16.1"W (409 mm) keyboards. Made of strong, lightweight aluminum. This tray does not support the mouse pad attachment.

Part Number	Description	Shipping Weight lb (kg)
11690-X23	23" Full Size Sliding Keyboard & Mouse	12 (5.4)
15555-X19	Flush Mount Sliding Keyboard with Wrist Rest, For 19" Racks	8.5 (3.9)
15556-X23	Flush Mount Sliding Keyboard with Wrist Rest, For 23" Racks	10 (4.5)
12717-X19*	Flush Mount Keyboard Tray, For 19" Racks	8 (3.6)

X=color: 1=Gray, 2=Computer Beige, 5=Clear, 7=Black, E=Glacier White

\*19" rack tray must use small footprint keyboard.

2U

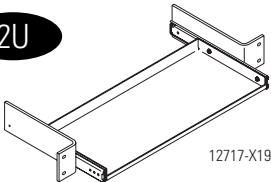

12717-X19

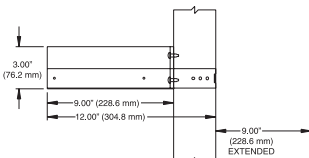

# KEYBOARD TRAYS

2U

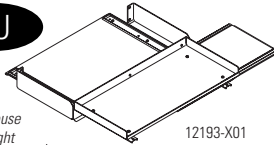

12193-X01

Note: Mouse pad on right side only

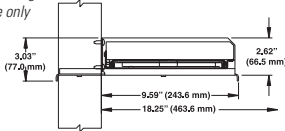

2U

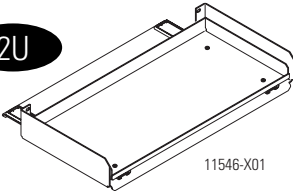

11546-X01

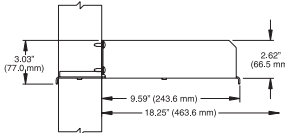

1U

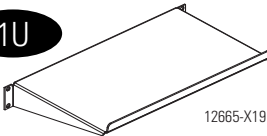

12665-X19

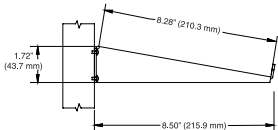

1U



13490-719

Keyboard without tray also available

## 19" Full Size Sliding Keyboard & Mouse Tray

Holds full size keyboard and mouse. Slide is mounted under shelf to provide maximum tray width. Mounting hardware not included. Mouse pad tray is 10" W x 8" D (250 mm x 200 mm) and retracts out of the way when not in use. Fits up to 19.25" W x 9" D (489 mm x 230 mm) keyboards. Extends approximately 9" (230 mm) for full access to keyboard. Made of strong, lightweight aluminum.

## 19" Full Size Sliding Keyboard Tray

Tray holds full size keyboard with slide mounted under shelf to provide maximum tray width. Mounting hardware not included. Extends approximately 9" (230 mm) for full access to keyboard. Fits up to 19.25" W x 9" D (489 mm x 230 mm) keyboards. Made of strong, lightweight aluminum.

Note: Does not support the mouse pad attachment.

## Keyboard and Tray

The Keyboard and Tray features a built-in touchpad, two PS/2 standard connectors: one for the keyboard and one for the touchpad (mouse). Requires only 1U of space. Slides into the cabinet or rack when not needed. Gold Contact Keyboards provide an extremely clean signal, improving the overall signal integrity. Mounting hardware not included; ships fully assembled.

## Space-Saving Stationary Keyboard Shelf

CPI's Space-Saving Stationary Keyboard Shelf was designed to be used in high-density server installations. The shelf incorporates a rigid 10° angled surface for keyboard support, providing comfortable and convenient keyboard positioning and operation. Mounting hardware not included. Available in 19" W or 23" W x 8.28" D (210.3 mm). Made of strong, lightweight aluminum.

Part Number	Description	Shipping Weight lb (kg)
12193-X01*	19" Sliding Keyboard Tray	9 (4.1)
11546-X01	19" Full Size Keyboard Tray	9 (4.1)
12665-X19	Space-Saving Shelf, For 19" Racks	3 (1.4)
12665-X23	Space-Saving Shelf, For 23" Racks	3 (1.4)
13490-X19	2-Post, Keyboard+Tray, Black	13 (5.9)
13490-X29	2-Post, Keyboard+Tray, with Gold Contacts	13 (5.9)
13480-X19	4-Post, Keyboard+Tray, Black	12 (5.4)
13480-X29	4-Post, Keyboard+Tray, with Gold Contacts	12 (5.4)
23480-001	Keyboard Only	3 (1.4)
23480-002	Keyboard with Gold Contacts	3 (1.4)

X-color: 1=Gray, 2=Computer Beige, 5=Clear, 7=Black, E=Glacier White

\*Also available, Mouse Pad Attachment (P/N 11692-XXX) and 23" Wrist Rest Attachment (P/N 12306-XXX).



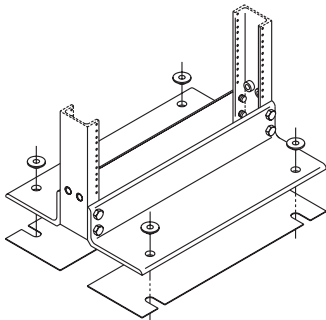

### Rack Base Insulator Kit

Rack Base Insulator Kits electrically isolate the racks from the floor for an effective grounding and bonding system. Made of .062" (1.57 mm) thick phenolic insulating material and accepts up to 0.5" (10 mm) diameter screws. Used primarily on concrete floors, not needed for raised-floor applications.

**Kit consists of:**

- (2) isolation plates
- (4) isolation grommets

Part Number	Description	Shipping Weight lb (kg)
10605-019	Insulator Kit, 19" Rack	3 (1.4)
10605-023	Insulator Kit, 23" Rack	3 (1.4)

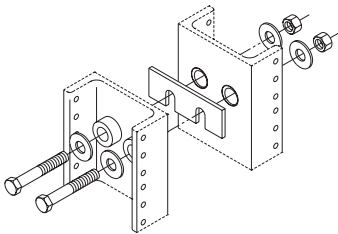

### Rack Line-Up Spacer Kit

Bolts and spacer securely attach two racks mounted side-by-side.

**Universal Rack Kit consists of:**

- (2) spacer plates 1" x 3" x 1/8" (30 mm x 80 mm x 3.18 mm) thick aluminum
- (4) 5/16-18 x 2" hex cap screws
- (4) 5/16-18 hex nuts
- (8) 5/16 plain washers

**Standard Rack Kit consists of:**

- (2) spacer plates 1" x 3" x 1/8" (30 mm x 80 mm x 3.18 mm) thick aluminum
- (4) 1/2-20 x 1" hex cap screws
- (4) 1/2-20 hex nuts
- (4) 1/2 plain washers

Part Number	Description	Shipping Weight lb (kg)
40602-X00	Kits for Universal Racks	1 (0.5)
40702-X00	Kits for Standard Racks	1 (0.5)

X=color: 1=Gray, 2=Computer Beige, 5=Clear, 7=Black, E=Glacier White

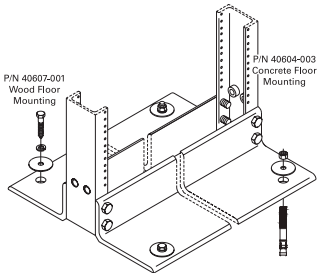

### Rack and Frame Installation Kits

Required hardware for securing equipment racks and frames to both concrete and wood floors. Concrete Kit has four 3/8" thread components or four 1/2" thread components. Wood kit has four 3/8" thread components.

Part Number	Floor Type	Finish	Shipping Weight lb (kg)
40604-001	Concrete Floor, 3/8"	Zinc	1 (0.5)
40604-003	Concrete Floor, 1/2"	Zinc	1 (0.5)
40607-001	Wood Floor, 3/8"	Zinc	1 (0.5)

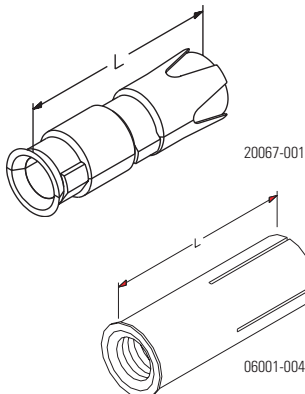

## Anchors

Use to secure threaded rods or stud bolts in concrete or masonry. The 20067-001 Anchor is used with 3/8-16 threaded rods, and the 06001-004 Anchor is used with 5/8-11 threaded rods. To install the 06001-004 Anchor, use the specially designed Anchor Setting Tool (P/N 06003-001).

*Installation instructions included. Sold individually.*

Part Number	Description	Length	Drill Dia.	Min. Hole Depth
20067-001	3/8-16 Exp. Shield	2"	5/8"	2-1/8"
06001-004	5/8-11 Multi-Set	2-1/2"	7/8"	2-1/2"
06003-001	Anchor Setting Tool	N/A	N/A	N/A

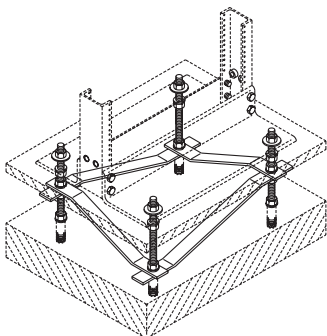

Rack with 3" (80 mm) channel shown



13501-119

## Raised Floor Rack Support

Used to support equipment racks installed on 4" to 36" (100 mm to 910 mm) height raised floor support systems. Enhances structural integrity during seismic events.

- Racks are mounted to sub or base floor using 5/8" threaded rods and steel brackets
- Steel brackets finished in gray color

### Kits consists of:

- (4) pre-cut threaded rods
- (4) "Z" brackets
- All mounting hardware

*Note: To install the anchors, use the specially designed anchor setting tool (P/N 06003-001). Sold separately.*

3" (80 mm) Rack Channel			
19" Rack	23" Rack	Height of Floor in (mm)	Shipping Weight lb (kg)
10632-119	10632-123	4 to 10 (100 to 250)	15 (6.8)
10629-119	10629-123	10 to 16 (250 to 410)	18 (8.2)
10630-119	10630-123	16 to 22 (410 to 560)	20 (9.1)
10631-119	10631-123	22 to 28 (560 to 710)	23 (10.4)
13501-119	13501-123	30 to 36 (760 to 910)	34 (15.4)
6" (150 mm) Rack Channel			
11760-119	11760-123	4 to 10 (100 to 250)	15 (6.8)
11761-119	11761-123	10 to 16 (250 to 410)	18 (8.2)
11762-119	11762-123	16 to 22 (410 to 560)	21 (9.5)
11763-119	11763-123	22 to 28 (560 to 710)	24 (10.9)
13515-119	13515-123	30 to 36 (760 to 910)	34 (15.4)

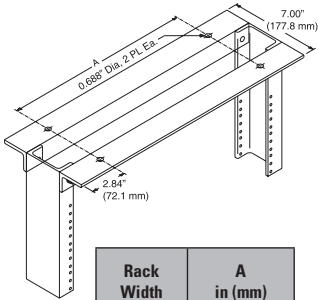

Rack Width	A in (mm)
19"	14.57 (370.1)
23"	18.57 (471.1)

## Heavy Duty Top Angle

Optional top angle for CPI Universal, 3"D (80 mm) Standard or 6"D (150 mm) Standard Rack.

- Material is aluminum extrusion
- Top Angle is L-shaped and 1-1/2" x 2" x 1/4" (38 mm x 51 mm x 6.4 mm) thick
- Recommended for use in pairs with Universal Earthquake Bracing Kit P/N 10562-001
- Sold individually

Part Number	Description	Shipping Weight lb (kg)
10473-X01	For 19" Rack	3 (1.4)
10473-X02	For 23" Rack	3 (1.4)

X=color: 1=Gray, 2=Computer Beige, 5=Clear, 7=Black, E=Glacier White

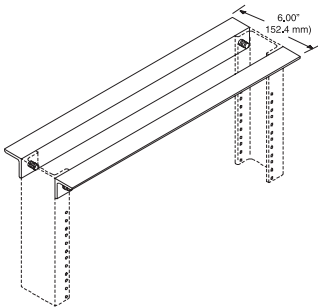

## Top Angle

Optional top angles for CPI Universal Rack.

- Material is aluminum extrusion 1-1/2" x 1-1/2" x 1/4" (38 mm x 38 mm x 6.4 mm)
- Sold individually

Part Number	Description	Shipping Weight lb (kg)
10375-X01	For 19" Rack	3 (1.4)
10375-X02	For 23" Rack	3 (1.4)

X=color: 1=Gray, 2=Computer Beige, 5=Clear, 7=Black, E=Glacier White

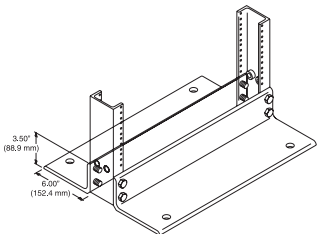

## Base Angle

Optional base angle for CPI Universal Racks.

- Material is aluminum extrusion 3-1/2" x 6" x 3/8" (89 mm x 150 mm x 9.53 mm)
- Sold individually

Part Number	Description	Shipping Weight lb (kg)
41021-X01	For 19" Rack	10 (4.5)
41021-X02	For 23" Rack	10 (4.5)

X=color: 1=Gray, 2=Computer Beige, 5=Clear, 7=Black, E=Glacier White

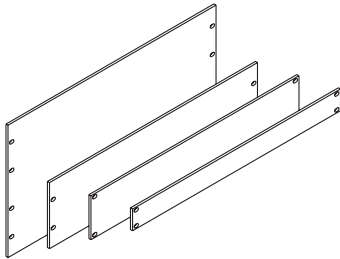

## Filler Panels

For airflow control and/or equipment mounting, fill empty spaces between mounted equipment.

Filler Panels	
300	Filler Panels

	Thickness - in (mm)	Width
24	3/16 (4.763)	19"
25	3/16 (4.763)	23"
26	1/8 (3.18)	19"
27	1/8 (3.18)	23"

Color	
1	Gray
2	Computer Beige
5	Clear
7	Black
E	Glacier White

	Spaces - in (mm)	U
01	1.72 (43.7)	1
02	3.47 (88.1)	2
03	5.22 (132.6)	3
04	6.97 (177.0)	4
05	8.72 (221.5)	5
06	10.47 (265.9)	6
07	12.22 (310.4)	7
08	13.97 (354.8)	8
09	15.72 (399.3)	9
10	17.47 (443.7)	10
11	19.22 (488.2)	11
12	20.97 (532.6)	12

300	XX	-	X	XX
-----	----	---	---	----



12 oz (340 g)  
pressurized can



25401-X00

## Touch-Up Paint

Air dry lacquer for touching up finish. Matches color and gloss of CPI's textured paint. Air dries to hard finish in minutes.

- 12-ounce (340 g) pressurized can Note: Cannot be shipped via air.

Air dry waterborne paint for touching up finish. Matches color and gloss of CPI's textured paint.

- 1-ounce (30 g) bottle with applicator

Part Number	Description oz (g)	Shipping Weight lb (kg)
25400-X00	12 (340) Can	2 (0.9)
25401-X00	1 (30) Bottle	1 (0.5)

X=Color; 1=Gray, 2=Computer Beige, 7=Black, E=Glacier White.

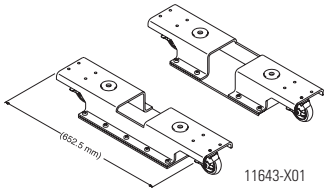

11643-X01

Note: Vertical cabling sections cannot be used on dolly-equipped racks. Also, dolly will not fit 6"D (150 mm) Standard Rack.

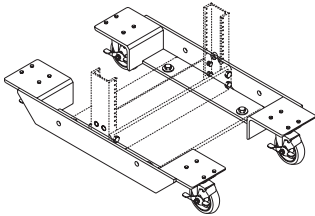

10175-X00

Note: Vertical cabling sections cannot be used on dolly-mounted racks. Can be used with Universal, 3"D (80 mm) Standard or 6"D (150 mm) Standard Racks.

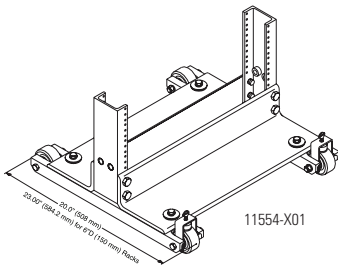

11554-X01

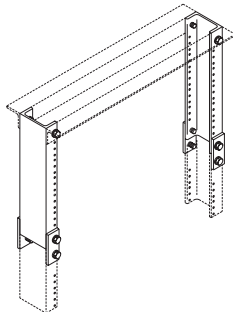

### Mid-Size Rack Dolly

Full swivel capability allows rack to be easily moved, providing access to equipment. The front wheel locks to prevent unintentional movement. Mounts to most CPI Universal and Standard Racks and adds 1-1/4" (31.8 mm) to rack's height. Two-piece construction of 1/4" (6.4 mm) aluminum complete with hardware. Sold in pairs; load capacity 750 lb (340.2 kg).

### Rack Universal Dolly Wheels

Allows rack to be moved, providing access to equipment. Wheels may be locked to prevent moving during assembly stages. Holds any width CPI Universal or Standard Rack. Two-piece construction of 3/8" (9.53 mm) aluminum complete with rack-mounting hardware. Supports up to 1000 lb (453.6 kg).

Note: Not to be used with enclosures.

### Rack Standard Rollers

Mount to CPI Universal and Standard Racks, regardless of width. Fixed rollers prevent rack from accidental turning. Adds 2" (50 mm) to rack's height. Ships complete with installation hardware. Supports up to 500 lb (226.8 kg).

Part Number	Description	Shipping Weight lb (kg)
11643-X01	Mid-Size Rack Dolly	24 (10.9)
10175-X00	Universal Dolly Wheels	20 (9.1)
11554-X01	Rack Standard Rollers, For 3"D (80 mm) Rack Channel	8 (3.6)
11554-X03	Rack Standard Rollers, For 6"D (150 mm) Rack Channel	8 (3.6)

X=color: 1=Gray, 2=Computer Beige, 5=Clear, 7=Black

### Rack Extension Kit

Provides additional height to existing racks. Kit includes one pair of rack channels, four plates and assembly hardware.

- Universal 5/8"-5/8"-1/2" (15.9 mm - 15.9 mm - 12.7 mm) hole pattern

Part Number	Description	Shipping Weight lb (kg)
10565-X12	12"H (300 mm), 4U	4 (1.8)
10565-X24	24"H (610 mm), 11U	6 (2.7)

X=color: 1=Gray, 2=Computer Beige, 5=Clear, 7=Black, E=Glacier White

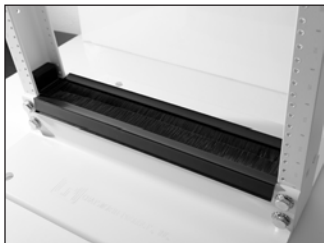

## KoldLok® 2-Post Rack Grommet

Designed to cover the opening between the base angles of a CPI Standard Rack 3"D (80 mm) P/N 55053-XXX, it prevents dust from collecting and forms a tight seal around cables to block airflow.

- Snaps-on to base angle for easy, tool-less installation
- Design allows installation on new or existing racks
- Durable sealing material will not break, stretch, tear or deform

Part Number	Description	Shipping Weight lb (kg)
13878-001	Each, Black	1 (0.5)
13878-002	Pack of 5, Black	4 (1.8)

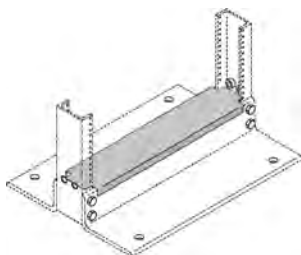

## Rack Base Dust Cover

Improves appearance and prevents the accumulation of dust and debris at the rack base. Snaps securely in place over the base assembly; no mounting hardware necessary. Made of lightweight aluminum.

- For CPI Racks with 3" or 6"D (80 mm or 150 mm) channel

Part Number			Description in (mm)
19" Rack	23" Rack	35" Rack	
41050-X19	41050-X23	N/A	3 (80) Rack Channel
42050-X19	42050-X23	42050-X35	6 (150) Rack Channel

X=color: 1=Gray, 2=Computer Beige, 5=Clear, 7=Black, E=Glacier White

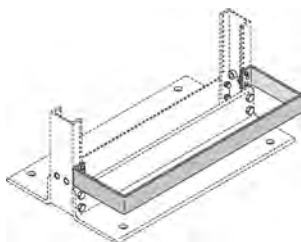

## Equipment Guard Rail

Provides protection for equipment in racks from rolling gear or tool boxes.

- Made of 1/4" x 2" (6.4 mm x 50 mm) aluminum bar
- Mounting hardware is included; sold individually

400		Equipment Guard Rails	
<b>Stand Off - in (mm)</b>			
56	7 (180)		
57	6.5 (165)		
58	5.25 (133.4)		
59	4.25 (108)		
<b>Color</b>			
1	Gray		
2	Computer Beige		
5	Clear		
7	Black		
E	Glacier White		
<b>Width</b>			
19	19" Rack		
23	23" Rack		
400	XX	-	X XX

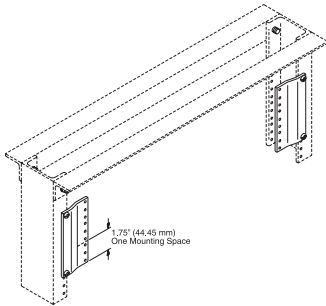

## Rack Panel Adapters (Pair)

Allows 19"W equipment to be mounted on a 23"W rack.

- Universal 5/8" - 5/8" - 1/2" (15.9 mm - 15.9 mm - 12.7 mm)
- Joggled so that installed panels fit flush

Part Number	Description Height in (mm)	Shipping Weight lb (kg)
31410-X00	Adapter, Pair, 1U, 1.71 (43.4)	1 (0.5)
31420-X00	Adapter, Pair, 2U, 3.46 (87.9)	1 (0.5)
31430-X00	Adapter, Pair, 3U, 5.21 (132.3)	1 (0.5)
31440-X00	Adapter, Pair, 4U, 6.96 (176.8)	1 (0.5)
31450-X00	Adapter, Pair, 5U, 8.71 (221.2)	1 (0.5)

X=color: 1=Gray, 2=Computer Beige, 5=Clear, 7=Black, E=Glacier White

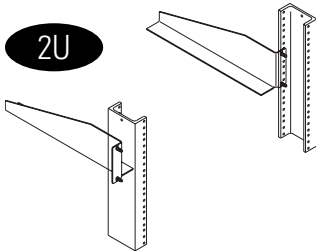

Sold in pairs. Attachment hardware not included.

## Equipment Support Bracket

The Equipment Support Bracket mounts on the rear of the rack channel to provide safety and additional support for deep or heavy electronic equipment rack-mounted on CPI Racks.

- Supports electronic equipment up to 24"D (610 mm) and weighing up to 60 lb (27.2 kg)
- Made of strong, lightweight aluminum
- Overall depth is 13" (330 mm); chassis support lip is 1.5"W (38 mm)
- Fits all EIA standard hole pattern rack channels

Part Number	Description	Shipping Weight lb (kg)
12312-X01	Pair of Brackets	2 (0.9)

X=color: 1=Gray, 2=Computer Beige, 5=Clear, 7=Black, E=Glacier White



## RMU Label Kits

Easy-to-read numbers take the guesswork out of aligning components.

- Two kits are available: 1-45U for 7' (2.1 m) racks and cabinets and 1-58U for 8' or 9' (2.4 m or 2.7 m) racks and cabinets
- Kit contains four individual label packs, enough for four racks or four cabinets
- Labels are constructed of 1/2"W (10 mm) durable polyester film with adhesive backing and are Black with rack-mount unit numbers printed in White

Part Number	Description	Shipping Weight lb (kg)
11927-001	1-45U Label	1 (0.5)
11927-002	1-58U Label	1 (0.5)

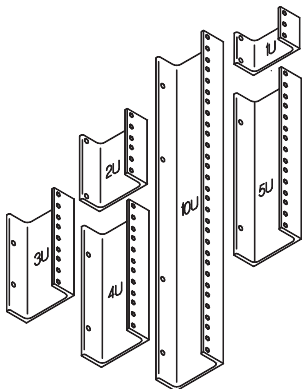
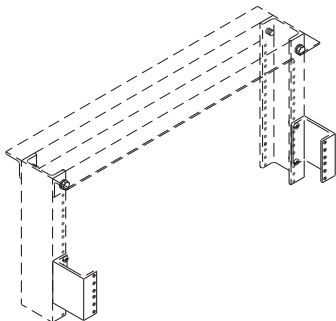

Front of channel tapped with #12-24 threaded holes, EIA 310 Universal holes spacing

## Rack Channel Standoffs

Rack Channel Standoffs offer solutions to many electronic component positioning problems, including:

- Adding deeper electronic components to existing CPI Wall Racks, Heavy Duty Wall Racks, Universal Swing Gate Wall Racks, Standard Swing Gate Wall Rack or Self-Support Racks
- Providing improved patch panel cable transitions when a double-sided cabling section is used with a 3" (80 mm) Rack Channel; use 1-1/2" (38 mm) Rack Channel Standoff
- Reposition rack-mounted electronic components to redistribute component weight or to realign component for whatever reason
- Available in three depths and six heights
- Packaged one pair per box

3" (80 mm) Rack Channel			
Part Number	Overall Height	Mounting Holes	Shipping Weight lb (kg)
<b>3" Depth (80 mm)</b>			
12309-X01	1U	3	1 (0.5)
12309-X02	2U	6	1 (0.5)
12309-X03	3U	9	2 (0.9)
12309-X04	4U	12	2 (0.9)
12309-X05	5U	15	2 (0.9)
12309-X10	10U	30	4 (1.8)
<b>6" Depth (150 mm)</b>			
12310-X01	1U	3	1 (0.5)
12310-X02	2U	6	1 (0.5)
12310-X03	3U	9	2 (0.9)
12310-X04	4U	12	2 (0.9)
12310-X05	5U	15	2 (0.9)
12310-X10	10U	30	4 (1.8)
<b>1-1/2" Depth (38 mm)</b>			
12311-X01	1U	3	1 (0.5)
12311-X02	2U	6	1 (0.5)
12311-X03	3U	9	2 (0.9)
12311-X04	4U	12	2 (0.9)
12311-X05	5U	15	2 (0.9)
12311-X10	10U	30	4 (1.8)

X=color: 1=Gray, 2=Computer Beige, 5=Clear, 7=Black, E=Glacier White



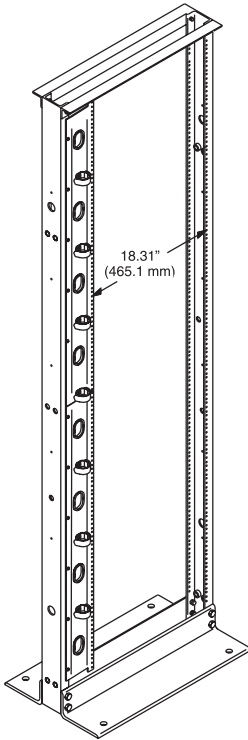

## Panel Adapter with Cable Management, Single-Sided, 23" to 19"

CPI offers a solution for those who have 7'H (2.1 m) x 23"W racks and need to mount 19" equipment along the entire length of the rack. Existing panel adapters are typically composed of two side panels, which reduce the mounting width and center the equipment. CPI's unique design performs the reduction on one side. Not only can you mount 19" equipment, but you also have room for cable management on the wide adapter panel.

Eight 2.25" (57.2 mm) oval pass-through ports with edge protectors provide cable access from front to rear of the panel. In addition, there are seven threaded holes along the front surface of the panels for mounting optional Center Grommet Buckle Saf-T-Grip® Cable Management Straps, to provide strain relief and vertical cable management.

- Includes (50) pilot point #12-24 mounting screws with combination Phillips/Straight heads
- Saf-T-Grip straps are optional
- Split design allows you to adapt half or all of a 7'H (2.1 m) relay rack
- Adapter panels mount on right or left side of rack
- Panels are joggled to maintain uniform mounting surface plane
- For lightweight applications (patch panels & cable management)

Part Number	Description/Color	Shipping Weight lb (kg)
<b>7' (2.1 m) Panel Adapters</b>		
13044-X03	7'H (2.1 m) Panel Adapters	5 (2.3)
<b>OPTIONAL: Saf-T-Grip Center Grommet Cable Management Straps (Pkg. of 25) W x L - in (mm)</b>		
06006-201	3/4 x 6 (19.1 x 150), Black	1 (0.5)
06006-203	3/4 x 6 (19.1 x 150), Royal Blue	1 (0.5)
06009-201	3/4 x 9 (230 x 19.1), Black	1 (0.5)
06009-203	3/4 x 9 (230 x 19.1), Royal Blue	1 (0.5)
06012-201	3/4 x 12 (300 x 19.1), Black	1 (0.5)
06012-203	3/4 x 12 (300 x 19.1) Royal Blue	1 (0.5)

X=color: 1=Gray, 2=Computer Beige, 5=Clear, 7=Black, E=Glacier White

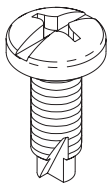

## Combination Pan Head, Pilot Point, Mounting Screws

The #12-24 Combination Pan Head, Pilot Point, Mounting Screws attach equipment to racks and cabinets. A cutting notch in the thread removes paint in threaded holes to improve metal-to-metal contact. The pilot point reduces cross-threading. The combination head can be used with #3 Phillips and slotted screwdrivers.

- Available in choice of Zinc plated or Black finish in packages of 50 and 1000

Part Number	Nominal Size	Package Of	Shipping Weight lb (kg)
40605-001	12-24	50	1 (0.5)
40605-004	12-24	1000	9 (4.1)
40605-005	12-24 (Black)	50	1 (0.5)
40605-006	12-24 (Black)	1000	9 (4.1)

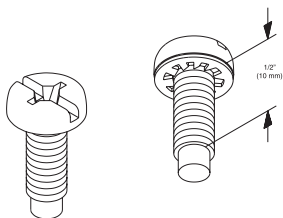

## Combination Pan Head, Pilot Point, Sems Mounting Screws

Similar to 40605, except includes captive lock washer.

- Zinc plated finish

Part Number	Nominal Size	Package Of	Shipping Weight lb (kg)
40606-001	12-24	50	1 (0.5)

STRUCTURED TERMINATION PRODUCTS ARE PRE-CONFIGURED FRAMES DESIGNED SPECIFICALLY TO HOLD 110-STYLE OR 66-STYLE BLOCKS OR PATCH PANELS. USE STRUCTURED TERMINATION PRODUCTS TO SUPPORT MAIN, INTERMEDIATE OR HORIZONTAL CROSS-CONNECTS.

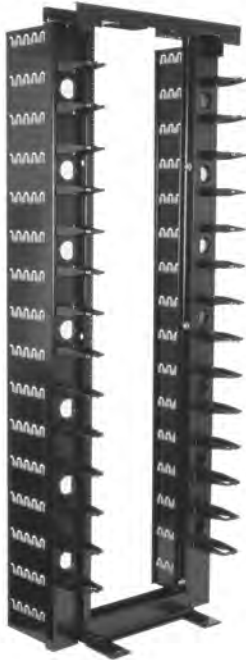

## High Density Patching Frame

Designed to maximize support of patch panels, the High Density Patching Frame combines the benefits of CPI's 2-post open racks and vertical cable management into a single package.

- High-density cable management fins provide an integrated vertical pathway for premise cabling and facilitate adherence to bend radius requirements
- Inverted U-shaped tabs formed into the cable management fins provide a quick method for securing premise cabling with Saf-T-Grip® Cable Management Straps
- Cable management rings and integrated upper jumper tray provide slack management for patch cords
- Feed patch cords front-to-rear through edge-protected pass-through ports
- Base angles are pre-punched for direct attachment to building structure and feature a U-shaped cut-out for cable delivered from under a raised floor
- Connect Frames side-by-side into continuous rows with an accessory baying kit
- Attach Cable Runway to the top of the frame with J-bolts in the perpendicular orientation or a Mounting Kit in the parallel orientation

### Specifications:

- Overall dimensions of 86.0"H x 29.1"W x 18.6"D (2184 mm x 739 mm x 472 mm)
- Provides 45U x 19"W of mounting space
- Features EIA-310-D, Universal spacing, threaded #12-24 mounting holes
- Frame components are aluminum, while cable rings are an engineered polymer
- UL Listed: File E140851; Category DUXR (US), DUXR7 (Canada) – Communications Circuit Accessory
- Finished with Black, powder coat paint
- Ships unassembled and individually packaged
- Assembly requires one person, a standard ratchet/wrench set, screwdriver and square
- Attach to building structure using one Rack Installation Kit per frame
- Supports 750 lb (340.2 kg) of cable and equipment; 110 lb (49.9 kg) maximum per cable fin



Integrated top jumper trough provides smooth transition



Unique fins support large bundles of cable

Part Number	Description	Shipping Weight lb (kg)
55100-703	7'H (2.1 m) x 19"W High Density Patching Frame, Black	63 (28.6)
55104-701	Baying Kit, Black	1 (0.5)
55105-X12	12"W (300 mm) Runway Mounting Kit	1 (0.5)
55105-X18	18"W (460 mm) Runway Mounting Kit	1 (0.5)
55105-X24	24"W (610 mm) Runway Mounting Kit	1 (0.5)

X=color: 7=Black, E=Glacier White. 55100-703 and 55104-701 available in black only.

# XLBET 110A BLOCK MOUNTING SYSTEM

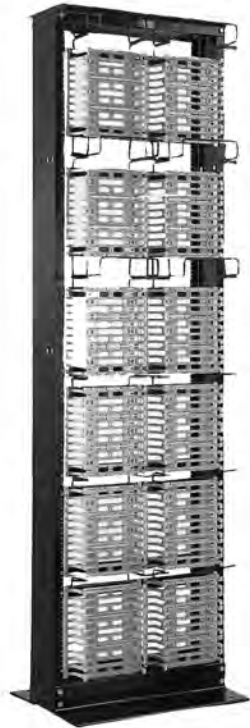

Shown with wiring blocks (not included)

## XLBET 110A Block Mounting System

The Extra Large Building Entrance Terminal (XLBET) 110A Block Mounting System is designed for high-density, vertical, space-saving style block mounting. The 8"W x 6.6"D (200 mm x 168 mm) large wire managers provide distinct vertical and horizontal cable and jumper pathways for efficient space usage. The basic frame (23" or 35"), mounting bars and the small and large wire managers are available under one part number. The XLBET 110A Block Mounting System ships completely assembled for quick, easy installation.

- Supports 300 pair 110A style blocks
- 3600 pair in two columns to 5400 pair in three columns can be mounted per side, depending on the frame selected
- Double-sided version provides 7200 to 10,800 pair, depending on the frame selected
- Horizontal and vertical cable managers provide clearly defined cable routing of large quantities of cross-connect wires
- 6"D (150 mm) rack channel provides extra cable capacity

### 11810-X36 Kit (3600 pair/12 blocks/single sided) consists of:

- (1) 23" Standard Rack, 6"D (150 mm) (P/N 66383-X03)
- (6) Mounting Bars
- (3) Large Wire Managers, (3) Small Wire Managers

### 11810-X72 Kit (7200 pair/24 blocks/double-sided) consists of:

- (1) 23" Standard Rack, 6"D (150 mm) (P/N 66383-X03)
- (12) Mounting Bars
- (6) Large Wire Managers, (6) Small Wire Managers

### 11910-X54 Kit (5400 pair/18 blocks/single-sided) consists of:

- (1) 35" Standard Rack, 6"D (150 mm) (P/N 66363-X03)
- (6) Mounting Bars
- (3) Large Wire Managers, (3) Small Wire Managers

### 11910-X80 Kit (10800 pair/36 blocks/double-sided) consists of:

- (1) 35" Standard Rack, 6"D (150 mm) (P/N 66363-X03)
- (12) Mounting Bars
- (6) Large Wire Managers, (6) Small Wire Managers

Part Number			
23" Width		35" Width	
3600 Pair	7200 Pair	5400 Pair	10,800 Pair
11810-X36	11810-X72	11910-X54	11910-X80

X=color: 1=Gray, 2=Computer Beige, 5=Clear, 7=Black, E=Glacier White

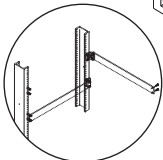
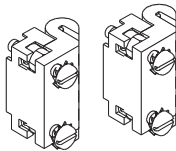

## Panel Hinges

Versatile 1.75"H (44.45 mm) rack-mounting hinges provide rear access to patch panels or other shallow equipment by allowing them to swing outward. Made from high-strength black composite material.

- Sold in pairs with mounting hardware included
- Supports up to 30 lb (13.6 kg) per pair

Part Number	Description	Shipping Weight lb (kg)
11520-001	Hinges, Pair	1 (0.5)

## 66 Block Mounting Brackets

Used to organize and manage 66 blocks at one convenient location. Includes U-shaped cable loops to route jumper cables between blocks.

- 19" Mounting Bracket: 8 blocks (2 rows of 4), 400 pair, 5 cable loops
- 35" Mounting Bracket: 18 blocks (2 rows of 9), 900 pair, 10 cable loops
- Mounting hardware not included

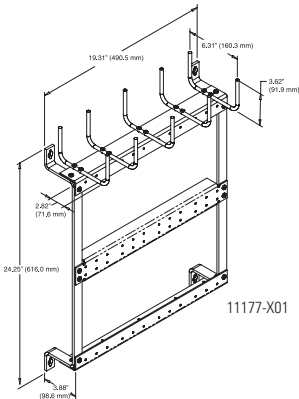

11177-X01

Part Number	Description	Shipping Weight lb (kg)
11177-X01	19" Mounting Bracket	2 (0.9)
11188-X01	35" Mounting Bracket	2 (0.9)

X=color: 1=Gray, 2=Computer Beige, 5=Clear, 7=Black, E=Glacier White

## Block Mounting Bar, Rack-Mounted

For mounting terminal blocks, card files and other equipment on 19" and 23" racks.

- Angle mounting bars are 1/8" (3.18 mm) cold-rolled steel
- T-mounting bars are 1/8" (3.18 mm) extruded aluminum
- Hole patterns are 12-24 tapped on 7/16" (11.113 mm) centers
- Supports 66/89 Blocks; sold individually

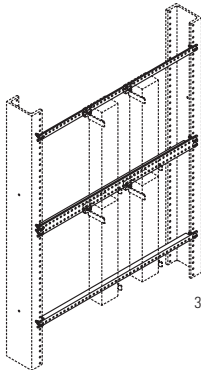

30014-X00

Part Number	Description	Shipping Weight lb (kg)
30013-X00	19" Angle	2 (0.9)
30014-X00	23" Angle	2 (0.9)
30015-X00	19" T-Bar	2 (0.9)
30016-X00	23" T-Bar	2 (0.9)

X=color: 1=Gray, 2=Computer Beige, 5=Clear, 7=Black, E=Glacier White

## Hinged Panel Mounting Bracket

Provides easy access to back of wall or rack-mounted panels.

- Can be mounted to open left or right
- Available in 2, 3, 4, 5 or 6 mounting space, 1.75"H (44.45 mm), 4" or 8"D (100 mm or 200 mm) and 19"W
- Mounting hardware not included; supports up to 30 lb (13.6 kg) load

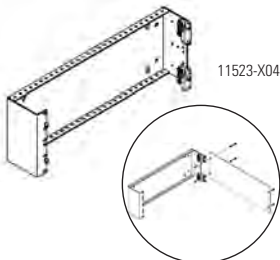

11523-X04

Part Number	Description	Shipping Weight lb (kg)
11521-X04	3.50 (88.9), 2U High, 4 (100) Deep	2 (0.9)
11522-X04	5.25 (133.4), 3U High, 4 (100) Deep	2 (0.9)
11523-X04	7.00 (177.8), 4U High, 4 (100) Deep	2 (0.9)
11524-X04	8.75 (222.3), 5U High, 4 (100) Deep	2 (0.9)
11525-X04	10.5 (267.0), 6U High, 4 (100) Deep	2 (0.9)

X=color: 1=Gray, 2=Computer Beige, 5=Clear, 7=Black, E=Glacier White  
Also available in 8"D (200 mm), (-X08).

# SEISMIC PROTECTION SYSTEMS

Bracing Products for Racks & Cabinets



Seismic Frame® Two-Post Rack

Seismic Protection Products - Racks

Seismic Protection Products - Runway

Seismic Protection Products - Cabinets

Z4-Series SeismicFrame® Cabinet System

Page 9-3

Page 9-6

Page 9-8

Page 9-9

Page 9-10

# SEISMIC PROTECTION SYSTEMS

It is much easier to prepare for the next seismic event than to predict it. This is especially important for data centers that cannot afford to be offline or are not backed up at a secondary location. To reduce this risk and minimize equipment damage, additional seismic bracing for racks, cabinets, runway and trays is required and used in many parts of the world.

Structural engineers can use CPI Seismic Protection Systems to reduce excessive motion that may cause undue strain on cable or conduit interconnection, which may help equipment remain operational.

## **OSHPD Pre-Approved Products:**

CPI is also helping customers reduce the Office of Statewide Health Planning and Development (OSHPD) approval cycle as they plan installations in seismically active regions by obtaining the OSHPD Pre-Approval (OPM) numbers for several CPI products. OSHPD is the regulatory agency for the state of California that oversees the construction of hospital facilities. When equipment such as CPI Racks, Cabinets and Enclosure Systems are installed in California hospitals, OSHPD is responsible for reviewing and approving the anchorage design, as well as the architectural structure design. Find OSHPD Pre-Approved (OPA) part numbers and other useful design tools at [www.chatsworth.com/designtools](http://www.chatsworth.com/designtools).

## **CPI Seismic Protection Systems feature:**

- Seismic Products for Rack Systems
- Seismic Products for Cable Runway and Tray
- Seismic Products for Cabinet and Enclosure Systems
- Z4-Series SeismicFrame® Cabinet System

**To reduce the risk of equipment damage from seismic events, check all codes, rules and regulations in your area. Utilize the service of a structural engineer, and follow his/her suggestions. CPI offers an assortment of Seismic Protection Systems to stiffen, brace and stabilize racks and rack-mounted equipment to comply with your structural engineer's recommendations.**

## **Featured Product:**



*Z4-Series SeismicFrame Cabinet  
Page 9-10*

Patented



Seismic Frame® Two-Post Rack populated with available accessories

## Seismic Frame® Two-Post Rack

CPI's Seismic Frame® Two-Post Rack is specifically designed to support network equipment in areas with seismic activity. The welded, steel Seismic Frame Two-Post Rack resists the swaying motion caused by earthquakes and reduces the amount of vibration transferred through the rack to equipment, so it is less likely to be damaged during a seismic event.

The Seismic Frame Two-Post Rack supports 19" EIA-310-D compliant or 23"W equipment with two pairs of mounting rails that can be spaced 6" (150 mm) or 3" (80 mm) apart. The mounting rails are marked and numbered with rack-mount units (U) and are available threaded or square-punched with painted or zinc-plated finish. This rack ships fully assembled and includes a Two Mounting Hole Ground Terminal Block for bonding the rack to the busbar. The rack is rated for a 1,000 lb (453.6 kg) seismic Zone 4 load, per Section 4.4 of the Telecordia® Technologies, Inc. GR-63-CORE Network Equipment Building Systems (NEBS) requirements.

### Features:

- Welded, steel network equipment rack engineered specifically to protect equipment in areas with seismic activity
- Available in two sizes; 24"W (610 mm) or 28"W (710 mm)
- Vertical Powers Strips and T-shaped Cable Management Fingers attach directly to the rack channel to provide power and cable distribution for equipment
- 19"W Rack fits within a 24" (610 mm) access floor tile
- Fully bonded rack has (2) masked grounding locations and includes a Two Mounting Hole Ground Terminal Block for easy connection to the Telecommunications Grounding Busbar
- Independently seismic-tested and certified, meets industry recognized Telecordia® Technologies, Inc. GR-63-CORE Network Equipment Building Systems (NEBS) Zone 4 requirements
- EIA-310-D Compliant
- UL Listed NWIN per UL60950, File E227626
- 1,000 lb (453.6 kg) load rating for seismic areas

### Rack Includes:

- (1) welded, steel frame
- (4) equipment mounting rails
- (50) each equipment mounting screws/cage nuts
- (1) Two Mounting Hole Ground Terminal Block



Adjustable Depth Mounting Rails



Two Mounting Hole Ground Terminal Block



# SEISMIC FRAME® TWO-POST RACK

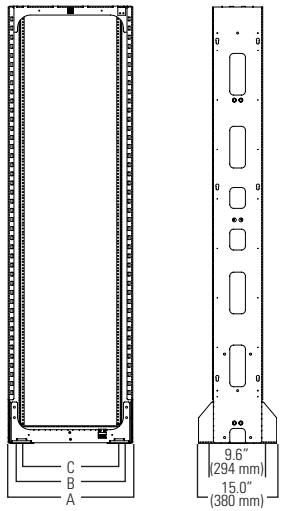

Description	19 in (mm)	23 in (mm)
Overall Width (A)	24.0 (610)	28.0 (710)
Frame Opening (B)	19.3 (490)	23.3 (592)
Rail Clearance (C)	17.75 (450)	21.75 (552)

## Seismic Frame Two-Post Rack

Open, two-post, seismic rack supports 19" EIA or 23" wide rack-mount equipment.

Part Number	Description H x W ft (m)	Shipping Weight lb (kg)
13853-X03	7 (2.1) x 19", 44U Tapped #12-24 Zinc Rails	180 (81.6)
13854-X03	7 (2.1) x 19", 44U Square-Punched Zinc Rails	178 (80.7)
13855-X03	7 (2.1) x 19", 44U Tapped #12-24 Painted Rails	180 (81.6)
13856-X03	7 (2.1) x 19", 44U Square-Punched Painted Rails	178 (80.7)
13883-X03	7 (2.1) x 23", 44U Tapped #12-24 Zinc Rails	185 (83.9)
13884-X03	7 (2.1) x 23", 44U Square-Punched Zinc Rails	183 (83.0)
13885-X03	7 (2.1) x 23", 44U Tapped #12-24 Painted Rails	185 (83.9)
13886-X03	7 (2.1) x 23", 44U Square-Punched Painted Rails	183 (83.0)

X=Color; 1=Gray, 2=Computer Beige, 7=Black.  
Install using (4) seismic-rated concrete anchors (sold separately).



## Cable Management Fingers Kit

Organize patch cords and jumper cables by rack-mount unit.

- 7U T-shaped plastic cable guides snap onto the front and rear of the rack frame
- Openings between the T-shaped guides align with each rack-mount unit on the rack
- Single-Sided Kit includes 12 cable guides for one side (front or rear) of the rack
- Double-Sided Kit includes 24 cable guides for both sides (front and rear) of the rack

Part Number	Description	Shipping Weight lb (kg)
13696-001	Cable Management Fingers Kit, Single-Sided	7 (3.2)
13696-002	Cable Management Fingers Kit, Double-Sided	14 (6.4)

Color is Black.

## Seismic Frame Two-Post Rack Accessories

### VCS Vertical Cabling Section

Two aluminum cable managers, 6"W x 6.38"D (150 mm x 162 mm), attach to align with the front and rear of the rack. Large cable pass-through ports on the back of each manager align with openings in the side of the frame; spin-open plastic latches secure cables in managers. Attach two CPI Vertical Power Strips to slots on the back of the manager using the mounting kit listed below. One Single-Sided Cable Management Fingers Kit included to organize cables.

13704-703



### VCS Vertical Cabling Section Offset Bracket

Brackets attach a Single-Sided Wide VCS (P/N 11374-X03) to the Seismic Frame Two-Post Rack so that it aligns with the front of the rack. Kit includes four brackets, use two brackets per side to attach the cabling section.

### Floor Drilling Template

Durable 28"W x 15"D (710 mm x 380 mm) aluminum template locates floor mounting holes for 19"W and 23"W Seismic Frame Two-Post Racks.

13703-701



### Concrete Floor Anchor

Includes four M12 x 5-1/8" Hilti HSL-3-G Heavy Duty Sleeve Anchors to attach Seismic Frame Two-Post Rack to a concrete slab floor. Minimum recommended thickness of the concrete slab on the ground floor is 5-1/2" (140 mm). Rack must be secured to the structural floor with spacing between racks determined by a licensed structural engineer familiar with seismic applications and codes.

13702-001



### Vertical Power Strip Mounting Kit

Includes mounting hardware that allows two CPI Vertical Power Strips to attach to the keyholes on the sides of the Seismic Frame Two-Post Rack or the back of the Vertical Cabling Section listed above. Cannot be used on the same side as the Vertical Cabling Section or Cable Management Fingers Kit.

13697-001



### Duplex Electrical Outlet Box

Provides a location for a power connection at the base of the rack. Includes a single-gang box for a single duplex receptacle and two self-tapping Torx head T25 installation screws. Outlet box is welded steel, 3-3/4"H x 1-13/16"W x 2-1/2"D (95 mm x 46 mm x 64 mm) with a 15.5 in<sup>3</sup> (250 cm<sup>3</sup>) wiring capacity, has eight (four accessible) concentric knockouts for 1/2" or 3/4" conduit and is zinc galvanized for corrosion protection. UL Listed.

13698-001

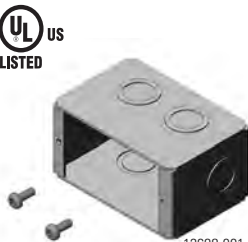

Part Number	Description	Shipping Weight lb (kg)
13704-X03	VCS Vertical Cabling Section, Black	35 (15.9)
13699-701	VCS Offset Mounting Bracket Kit, Black	2 (0.9)
13703-701	Floor Drilling Template, Black	6 (2.7)
13702-001	Concrete Floor Anchor Kit	3 (1.4)
13697-001	Vertical Power Strip Mounting Kit	1 (0.5)
13698-001	Duplex Electrical Outlet Box, Zinc	1 (0.5)

P/N 13704-X03, X=color; 1=Gray, 2=Computer Beige, 7=Black

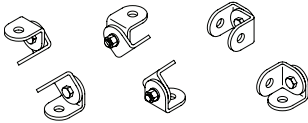
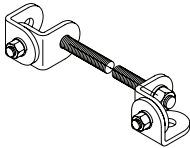

## Universal Earthquake Bracing Kit

This adjustable wall/ceiling brace provides a means of securing an equipment rack or auxiliary frame to meet earthquake safety codes.

- Material is 2" x 1/4" (50 mm x 6.35 mm) steel finished with Gold Chem Film over zinc plating

### Kit consists of:

- (4) brackets (make 2 swivel brackets)
- (2) 1/2-13 x 1 1/4" hex bolts
- (2) 1/2-13 hex nuts
- (2) 1/2" split lock washers

Part Number	Description	Shipping Weight lb (kg)
10562-001	Universal Earthquake Bracing Kit	3 (1.4)

*Note: Seismic installation requirements should be approved by a licensed structural engineer.*

### Installation Drawings:

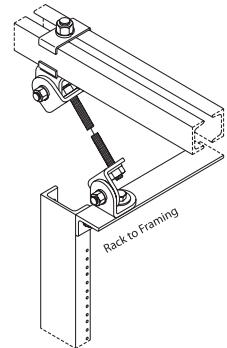
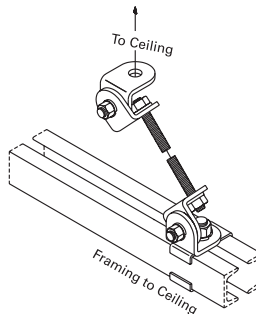
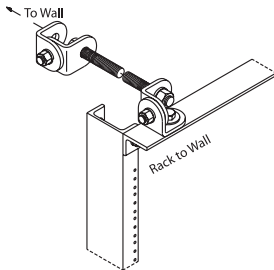

### Installation will require (not included):

- (1) 5/8-11 threaded rod of appropriate length  
Rod must be trimmed to proper length during installation
- (2) 5/8-11 hex nuts
- (2) 5/8 flat Type A washer, wide
- Clip kit and hardware for attachment to channel or bar

### Installation may also require (not included):

#### For concrete ceiling:

- (1) 5/8-11 concrete anchor
- (1) 5/8-11 x 3" stud
- (2) 5/8-11 hex nuts
- (1) 5/8" split lock washer
- (1) 5/8" flat, washer, wide, Type A

#### For rack:

- (1) 5/8-11 x 1 1/4" hex cap screw
- (1) 5/8-11 hex nut
- (1) 5/8" split lock washer

#### For auxiliary frame or grid:

- (1) Grid Clamp Kit
- (1) 5/8-11 x 3 1/4" hex screw cap
- (1) 5/8-11 hex nut
- (1) 5/8" split lock washer

#### For plywood backboard:

- (1) 5/8" x 2" hex lag screw
- (1) 5/8" split lock washer

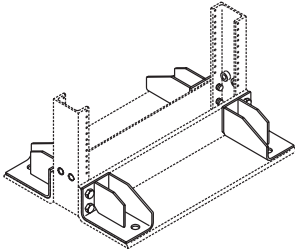

## Rack Seismic Gusset Kit

The Rack Seismic Gusset and Hardware Kit can be added to any CPI Universal Rack (46XXX series) to stiffen critical load bearing joints, reducing the need to stabilize the top of the rack.

- Adds additional support to critical rack joints
- Kit can be added to any CPI Universal Rack (46XXX series)

### Kit consists of:

- (4) welded steel bolt-on gussets
- (8) 1/2-13 x 1-1/4" bolts
- (8) 1/2-13 nuts

Part Number	Description	Shipping Weight lb (kg)
11592-X01	Gusset and Hardware Kit	10 (4.5)

*X=Color, 1=Gray, 2=Computer Beige, 7=Black*

*Note: Seismic installation requirements should be approved by a licensed structural engineer.*

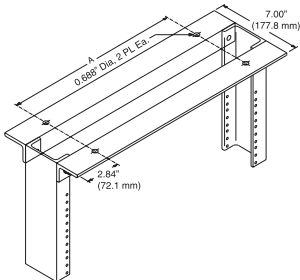

## Heavy-Duty Top Angle

Optional top angle for CPI Universal, Standard or 6"D (150 mm) Standard Racks.

- Material is aluminum extrusion, 1 1/2" x 2" x 1/4" (38.1 mm x 51 mm x 6.4 mm) with two 11/16" (17.46 mm) punched holes in top surface
- Recommended to be used in pairs with 10562-001 bracing
- Sold individually

Part Number			
19" Rack	Dim. A	23" Rack	Dim. A
10473-X01	14.57 (370.1)	10473-X02	18.57 (471.7)

*X=Color, 1=Gray, 2=Computer Beige, 5=Clear, 7=Black, E=Glacier White*

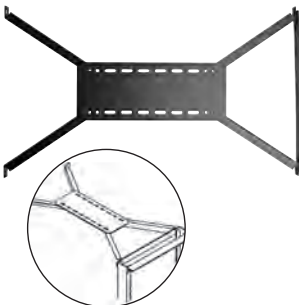

## Adjustable Bracing Kit For Racks

This adjustable, strong, easy-to-install rack bracing kit provides a cost-effective, attractive solution to bracing for equipment rack. Attaches directly to the wall.

- Adjustable 24" to 36"D (610 mm to 910 mm) from wall
- Made of strong, lightweight aluminum
- Available in 19" and 23" widths
- Available in four colors to complement rack installations

Part Number	Description	Shipping Weight lb (kg)
12407-X19	19"W Kit	6 (2.7)
12407-X23	23"W Kit	7 (3.2)

*X=Color: 1=Gray, 2=Computer Beige, 5=Clear, 7=Black*

*Note: For secure bracing, the rack/frame must be secured to the floor.*

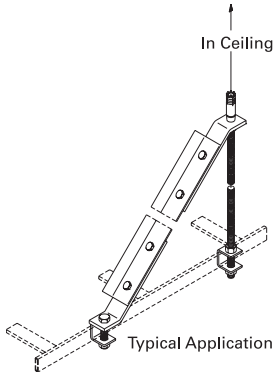

## Single Earthquake Bracing Kit

Stabilizes Cable Runway hung from threaded rods. Material is 2" x 3/8" (50 mm x 9.53 mm) steel with gold over zinc plating.

**Kit consists of:**

- (2) steel bars (45° angle)
- (4) 1/2-13 x 1 1/4" hex nuts & cap screws
- (4) 1/2" split lock washers

**Installation will require (not included):**

- Threaded rod and runway attachment hardware
- (1) 2" x 2" x 3/16" (50 mm x 50 mm x 4.763 mm) steel angle of appropriate length. See P/N 11420 (angle must be trimmed to proper length and drilled during installation)

Part Number	Description	Shipping Weight lb (kg)
10695-001	Single Earthquake Brace	8 (3.6)

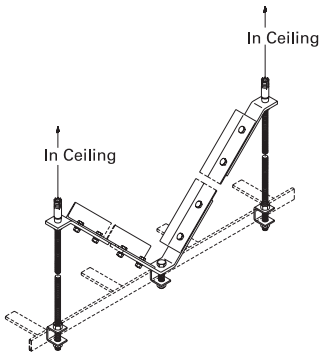

*Note: Seismic installation requirements should be approved by a licensed structural engineer.*

## Double Earthquake Bracing Kit

Stabilizes Cable Runway hung from threaded rods. Material is 2" x 3/8" (50 mm x 9.53 mm) steel with gold over zinc plating.

**Kit consists of:**

- (2) steel bars (45° angle)
- (1) "V" steel bar
- (8) 1/2-13 x 1 1/4" hex cap screws
- (8) 1/2-13 hex nuts
- (8) 1/2" split lock washers

**Installation will require (not included):**

- Threaded rod and runway attachment hardware
- (2) 2" x 2" x 3/16" (50 mm x 50 mm x 4.763 mm) steel angle of appropriate length. See P/N 11420 (angle must be trimmed to proper length and drilled during installation)

Part Number	Description	Shipping Weight lb (kg)
10696-001	Double Earthquake Brace	14 (6.4)

**Installation may also require (not included):**

**For concrete ceiling:**

- 5/8-11 concrete anchors
- 5/8-11 x 3 1/2" studs
- 5/8-11 hex nuts
- 5/8" split lock washers

**For secondary structure:**

- 5/8-11 threaded rod
- Grid Clamp Kits
- 5/8-11 hex cap screws
- 5/8-11 hex nuts
- 5/8" split lock washers



### Seismic Equipment Bracket for Cabinets

The Seismic Equipment Bracket prevents back-and-forth, side-to-side and up-and-down movement of shelf-mounted equipment by bracing the equipment's chassis to the cabinet's vertical mounting rails.

- Uses 1U of mounting space, securing equipment between 15" and 32" (380 mm and 810 mm) in depth
- The bracket easily adjusts into multiple configurations, which provides security for shelf-mount equipment of different depth or height
- The bracket will adjust in depth for use in any of CPI's 24", 30", 36" or 39"D (610 mm, 760 mm, 910 mm or 990 mm) MegaFrame®, SlimFrame®, SteelFrame, Seismic Frame® Cabinets and TeraFrame® Cabinets

19" Width	23" Width	Color	Shipping Weight lb (kg)
14061-119	14061-123	Gray	6 (2.7)
14061-219	14061-223	Computer Beige	6 (2.7)
14061-719	14061-723	Black	6 (2.7)



### Adjustable Bracing Kit for Cabinets

Attach bracing kit to cabinet top panel where there is a risk of seismic activity. Earthquake design criteria specify that equipment remain operational when subjected to earthquakes even though some small amount of repairable secondary physical damage may occur.

- Adjustable 24" to 36" (610 mm to 910 mm) distance from wall
- For use with M-Series, E-Series and Seismic Frame Cabinets

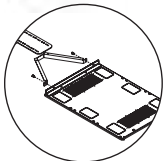

*Note: For secure bracing, attach the cabinet to the floor using the proper floor installation kit, along with CPI Floor Anchor Clamp provided with each cabinet.*

Part Number	Description	Shipping Weight lb (kg)
12477-X19	19"W Kit	6 (2.7)
12477-X23	23"W Kit	7 (3.2)

X=color: 1=Gray, 2=Computer Beige, 7=Black

# Z4-SERIES SEISMICFRAME CABINET SYSTEM



Load-Tested  
GR-63  
Zone 4

California  
OSHPD  
OPM-0112-13



OSHPD OPM-0112-13 provides pre-approved, code-compliant seismic designs of supports and attachments for the cabinet when used in health facilities in California.

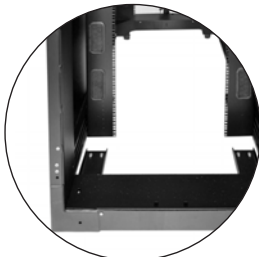

*Welded and bolted steel four-post frame.  
Seismic Load is 1500 lb (680 kg).*

## Z4-Series SeismicFrame® Cabinet System

The Z4-Series SeismicFrame® Cabinet System is an engineered solution specifically designed to store critical rack-mount server, data storage and network equipment in computer rooms, equipment rooms and other communications facilities that are located in active seismic areas.

Featuring an industry-leading 1500 lb (680 kg) equipment load, the Z4-Series SeismicFrame can also support an additional 100 lb (45 kg) top load for cabling. This cabinet was tested by a Telecommunications Carrier Group and ISO 17025 certified Independent Testing Laboratory (ITL) to meet the Telcordia Technologies GR-63-CORE, Issue 4, April 2012, Sections 4.4 per Zone 4 requirements. GR-63-CORE seismic testing includes a series of physical shaker table tests, during which a loaded cabinet is placed through simulated earthquake conditions. Zone 4 testing includes the most severe test conditions, in which the cabinet must perform with limited movement and survive the test without permanent structural or mechanical damage, ensuring the internal equipment is not damaged.

The cabinet is available with optional solid top panel, solid side panels and perforated doors. Top panel has four cable ports (one per corner). The side panels bolt on, and include locks. The front door is a single door with single point latch. The rear door is double (vertically split) with a three-point latch. Combine the Z4-Series SeismicFrame Cabinet with thermal and cable management accessories to create a solution that fits your exact needs.

### Cabinet Specifications:

- Available in 2 heights, 2 widths, 2 depths
- Provides front and rear support for 19"W (482.6 mm) EIA rack-mount equipment and shelves
- Adjustable depth, rails slide front-to-back
- Marks on frame for easy vertical alignment
- 1-3/4"H (44.45 mm) U spacing, marked and numbered
- 19"W, EIA-310-E Universal vertical hole spacing
- Seismic Load: 1500 lb (680 kg) internal seismic equipment load  
100 lb (45 kg) additional cabinet roof load
- Static Load: 3000 lb (1360 kg) per UL2416

### Cabinet Includes:

- Welded and bolted steel four-post frame
- Equipment mounting rails, two pairs
- Grounding/bonding system and ground lug
- Recessed leveling feet
- Removable transport casters
- Baying kit
- Equipment mounting hardware, (50) M6 cage nuts and screws

### Certifications:

- EIA-310-E compliant
- UL Listed 2416, NWIN, File #E227626
- TCG NEBS Compliant, Telcordia Technologies, GR-63-CORE, Issue 4, April 2012, Sections 4.4, per Zone 4 requirements
- OSHPD OPM-0112-13 California, Office of Statewide Health Planning and Development (OSHPD), Preapproval of Manufacturer's Certification (OPM)

## Cabinet Ordering Information:

Z4-Series SeismicFrame Cabinet is available in three basic configurations: a full cabinet with or without side panels, a cabinet with no doors with or without side panels or a frame only with no doors or panel work. Use the part number configurators below to select a Z4-Series SeismicFrame Cabinet. Choose Height, Width, Depth, Front Door, Locks and Sides based on your requirements.

**Example Cabinet Part Number: Z4-12U-113C-C12.**

### Z4-Series SeismicFrame Cabinets - Frame with Top Panels and Doors, Side Panels are optional.



Z4-12U-113C-C12  
shown

Z4	-	H	W	D	-	R	FD	RD	L	-	C	TP	SP
<b>Height</b>				<b>Rails</b>			<b>Side Panels</b>						
<b>U</b>	<b>in</b>	<b>mm</b>		Square-Punched		<b>0</b>	None						
40	78.7	1999	<b>1</b>		<b>1</b>	<b>2</b>	Solid, 2 Each						
43	83.9	2132	<b>2</b>	<b>Front Doors</b>			<b>Top Panel</b>						
<b>Width</b>				<b>Rear Doors</b>			<b>Color</b>						
<b>in</b>	<b>mm</b>			None		<b>0</b>	Black						
23.6	600	<b>1</b>		Single, Perf.		<b>1</b>	Glacier						
31.5	800	<b>2</b>		<b>Latches</b>									
<b>Depth</b>				<b>2-Point, Keyed</b>			<b>C</b>						
<b>in</b>	<b>mm</b>			Double, Perforated		<b>3</b>							
41.3	1050	<b>N</b>		<b>2-Point, Keyed Combination</b>			<b>E</b>						
47.3	1200	<b>U</b>											

### Z4-Series SeismicFrame Cabinets – Frame with Top Panel, no Doors, Side Panels are optional.



Z4-12U-1000-C10  
shown

Z4	-	H	W	D	-	R	FD	RD	L	-	C	TP	SP
<b>Height</b>				<b>Rails</b>			<b>Side Panels</b>						
<b>U</b>	<b>in</b>	<b>mm</b>		Square-Punched		<b>1</b>	None						
40	78.7	1999	<b>1</b>		<b>0</b>	<b>2</b>	Solid, 2 Each						
43	83.9	2132	<b>2</b>	<b>Front Doors</b>			<b>Top Panel</b>						
<b>Width</b>				<b>Rear Doors</b>			<b>Color</b>						
<b>in</b>	<b>mm</b>			None		<b>0</b>	Black						
23.6	600	<b>1</b>		<b>Latches</b>			<b>E</b>						
31.5	800	<b>2</b>		None		<b>0</b>							
<b>Depth</b>													
<b>in</b>	<b>mm</b>												
41.3	1050	<b>N</b>											
47.3	1200	<b>U</b>											



# Z4-SERIES SEISMICFRAME CABINET SYSTEM

## Cabinet Ordering Information:

### Z4-Series SeismicFrame Cabinets – Frame Only, No Top Panel, No Doors, or Side Panels.



Z4-12U-1000-C00 shown

Z4	-	H	W	D	-	R	FD	RD	L	-	C	TP	SP
----	---	---	---	---	---	---	----	----	---	---	---	----	----

Height		
U	in	mm
40	78.7	1999
43	83.9	2132

Width	
in	mm
23.6	600
31.5	800

Depth		
in	mm	
41.3	1050	N
47.3	1200	U

Rails	
Square-Punched	1

Front Doors	
None	0

Rear Doors	
None	0

Latches	
None	0

Side Panels	
0	None

Top Panel	
0	None

Color	
C	Black
E	Glacier

## Specification/Ordering Notes:

- There are eight possible frame sizes.
- Use the first matrix to order a complete cabinet with top, doors and sides; use the second matrix to order a cabinet with no doors; use the last matrix to order a frame only with no top, doors or sides.
- You must include a top panel when ordering a cabinet with doors.
- You can order a cabinet with or without side panels.
- You can order a cabinet with or without a front door.
- Choose latch/lock style: keyed or combination/keyed. Every door must have a latch.  
The (0) option should only be selected if there are no doors. Doors have a swing handle on the exterior. The combination lock uses a 3-digit combination entered on 3-dials that are integrated into the swing handle or a key. The combination lock can be reprogrammed in the field.
- The front door has a single-point latch; the rear door has a two-point latch.
- Heights, Widths, Depths: see tables below for detailed dimensions.

Height Dimensions - in (mm)			
Rack Mount Spaces (U)	Overall with Casters	Frame Only No Casters	Front Opening
40	78.7 (1999)	77.4 (1965)	70.4 (1789)
43	83.9 (2132)	82.6 (2099)	75.7 (1922)

Casters are factory-installed on the cabinet, used to move the cabinet into position and then removed before installation. The cabinet frame attaches directly to the floor.

Width Dimensions - in (mm)			
Nominal Width	Overall with Side Panels	Front Opening	Rack-Mount Panel Width
600	23.6 (600)	19.6 (498)	19 (482.6)
800	31.5 (800)	27.5 (698)	19 (482.6)

Mounting Rail clearance is 17.8" (452 mm), mounting hole spacing is 18.3" (465 mm).

Depth Dimensions - in (mm)			
Nominal Depth	Overall with Doors	Frame Only No Doors	Maximum Rail Depth
1050	45.1 (1146)	41.3 (1050)	35.8 (911)
1200	51.1 (1296)	47.2 (1200)	41.7 (1061)

Front Door is approximately 2.2"D (56 mm) and Rear Door is approximately 1.7"D (43 mm) with hinges/latches. Minimum rail depth is 10.2" (258 mm). The front rail is 6.7" (170 mm) deep; the rear rail is 3.5" (89 mm) deep. Rail Depth is reduced when vertical accessories are placed in corners.



## Air Dam Kit

Air Dam blocks airflow around the sides and top of the equipment mounting space, so cold air passes through equipment, and hot air does not recirculate around equipment.

- Use with Snap-In Filler Panels and Equipment Rail Grommet Kit
- Attaches to and adjusts with mounting rails
- Requires a minimum rail setback of 2.3" (58 mm) from the front of the frame
- Flexible seal against top and side panels
- Includes: top, bottom and side baffles; installation hardware
- Material: steel baffles, plastic seals
- Finish: Black or Glacier White; seals are Black
- Select part number to match the width, usable height and color of the cabinet

Part Number		Height (U)	Shipping Weight lb (kg)
23.6"W (600 mm)	31.5"W (800 mm)		
14435-X00	14435-X02	40	14 (6.4)
14435-X01	14435-X03	43	15 (6.8)

*X=Color; 0=Black, E=Glacier White. Shipping Weights are for 800 mm kits.*



## Equipment Rail Grommet Kit

Set of plastic grommets that cover cable openings in the equipment mounting rail to block airflow around equipment in the wider cabinets.

Part Number	Description H x W (in)	Shipping Weight lb (kg)
39133-001	Equipment Rail Grommet Kit, Pack of 8	2 (0.9)

*Note: Color is Black. Use with 31.5"W (800 mm) rails.*



## Snap-In Filler Panel

Snap-In Filler Panels block airflow in-between equipment by sealing unused rack-mount spaces (U) in the cabinet. Use with Air Dam to separate cold and hot air within the cabinet.

- Finish: Black or Glacier White
- Available in 1U and 2U heights, individual or bulk packs, color-matched to cabinet

Part Number			Height (U)	Shipping Weight lb (kg)
Each (1)	Pack (6)	Pack (50)		
34537-X00	34537-X01	34537-X02	1U	14 (6.4)
34538-X00	34538-X01	34538-X02	2U	21 (9.5)

*X=Color; 0=Black, E=Glacier White. Shipping Weights are for 50 pack.*



## Front-To-Rear Cable Manager

Front-to-Rear Cable Manager attaches to the back of equipment mounting rails, creating a front-to-rear pathway between the front and rear mounting rails for cables.

- For use on 31.5"W (800 mm) cabinets
- Mounting locations behind cable openings on each rail
- Attaches to mounting rails and extends from 17.5" (445 mm) to 30.5" (775 mm) to match rail depth
- Creates a 3.0"H (76 mm) by 2.5"W (64 mm) front-to-rear pathway for cables
- Includes: cable manager, installation hardware
- Material: steel panels
- Finish: Black or Glacier White
- Select part number to match the color of the cabinet

Part Number		Rail Depth Range in (mm)	Shipping Weight lb (kg)
23.6"W (600 mm)	31.5"W (800 mm)		
N/A	14485-X00	17.5 - 30.5 (445 - 775)	6 (2.7)

*X=Color; C=Black; E=Glacier White*



## Ring Cable Manager

Ring Cable Manager is independent of the equipment mounting rails, creating a separate vertical pathway for cables and includes plastic cable rings to organize cables.

- Attaches to the frame in a fixed location, independent of the equipment mounting rails
- Rings have an opening on the front for easy addition or removal of cables
- Includes: brackets, rings, installation hardware
- Material: steel brackets, plastic rings
- Finish: Black or Glacier White; rings are Black
- Select part number to match the width, usable height and color of the cabinet

Part Number		Height (U)	Shipping Weight lb (kg)
23.6"W (600 mm)	31.5"W (800 mm)		
14440-X00	14445-X00	40	13 (5.9)
14440-X01	14445-X01	43	13 (5.9)

*X=Color; C=Black; E=Glacier White. Shipping Weights are for 800 mm managers.*

Inside Dimensions, Usable Internal Cable Area, Rails Setback				
Cabin Width	Width in (mm)	Depth in (mm)	Cable Area in <sup>2</sup> (mm <sup>2</sup> )	Rail Setback in (mm)
23.6 (600)	.9 (29)	3.3 (84)	2.9 (1870)	9.5 (240)
31.5 (800)	4.2 (107)	3.5 (89)	14.7 (9480)	9.7 (246)

*Note: Rail setback is the minimum distance required between the front edge of the cabinet frame and the front edge of the equipment mounting rail.*

## Cable Lashing Bracket

Cable Lashing Bracket creates a simple, separate vertical pathway for a small bundle of cables and has multiple slots for CPI Saf-T-Grip® Straps or tie wraps to secure cables to the bracket.

- Attaches to the frame in a fixed location, independent of the equipment mounting rails
- Use multiple to increase capacity
- Bracket is 1.6"W (41 mm)
- Includes: brackets, installation hardware; order Saf-T-Grips or cable ties separately
- Material: steel
- Finish: Black or Glacier White
- Select part number to match the usable height and color of the cabinet

Part Number	Height (U)	Shipping Weight lb (kg)
14465-X00	40	3 (1.4)
14465-X01	43	3 (1.4)

*X=Color; C=Black, E=Glacier White*

## Full Height Dual PDU Bracket

Full Height Dual PDU Bracket supports two vertical PDUs side-by-side and has multiple slots for CPI Saf-T-Grip® Straps or tie wraps to secure cords to the bracket.

- Attaches to the frame in a fixed location, independent of the equipment mounting rails
- Available in two widths: Dual and Wide
- Dual bracket is 4.8"W (121 mm) and supports two PDUs up to 2.2"W (51 mm) side-by-side
- Wide bracket is 5.8"W (147 mm) and supports two PDUs up to 2.7"W (69 mm) side-by-side
- Wide bracket is required to mount two 6-breaker eConnect PDUs (series P/Ns PX-3XXXX) side-by-side; eConnect PDUs (series P/Ns PX-3XXXX) will only fit in the 43U cabinet.
- Tool-less mounting on 28" (711 mm), 61.25" (1556 mm) or 64.75" (1645 mm) centers
- Includes: brackets, installation hardware; order Saf-T-Grips or cable ties separately
- Material: steel
- Finish: Black or Glacier White
- Select part number to match PDU size, usable height and color of the cabinet

Part Number		Height (U)	Shipping Weight lb (kg)
Dual	Wide		
14480-X00	14481-X00	40	12 (5.4)
14480-X01	14481-X01	43	11 (5.0)

*X=Color; C=Black, E=Glacier White. Shipping weights are for Wide managers. eConnect PDUs (P/Ns PX-3XXXX) will not fit inside a 40U cabinet.*

# WALL-MOUNT SYSTEMS

Wall-Mount Racks, Cabinets & Accessories



Wall-Mount Racks - Hinged Swing Gate

Page 10-4

Wall-Mount Racks - Fixed Mount

Page 10-7

Wall-Mount Rack with Enclosure

Page 10-9

Wall-Mount Rack Accessories

Page 10-10

Cube-iT PLUS® Cabinet System

Page 10-11

ThinLine II Wall-Mount Cabinet

Page 10-16

Silver Frame Wall-Mount Cabinet

Page 10-18

# WALL-MOUNT SYSTEMS

As telecommunications needs continue to grow and expand, the physical space in which they exist does not always grow at the same rate. Wall-Mount Systems overcome this hurdle by providing racks and cabinets that allow you to create locations for cables and equipment where space is limited or does not exist. Secure equipment on the wall inside or outside of the telecommunications room and connect remote groups of users to the network. CPI offers several styles and options of fixed and swing gate Wall-Mount Racks and Cabinets available as either open or enclosed systems.

## **Wall-Mount Open Systems feature:**

- Mountable to wall or backboard
- Open architecture for airflow and easy access to cables
- Support of patch panels, shelves, trays and network equipment with roll-formed #12-24 tapped mounting holes
- 19" or 23" rack-mount width
- High-strength, lightweight aluminum construction (most models)
- Standard EIA-310-D hole pattern
- Fixed and swing-out designs for easier installation
- Offer up to 350 lb (158.8 kg) static load rating

## **Wall-Mount Enclosed Systems feature:**

- Mountable to wall or backboard
- Enclosed with lockable doors for security and aesthetic appeal
- 19" rack-mount width
- Standard EIA-310-D hole pattern
- Fixed and swing-out designs for easier installation
- Wall-mounted, floor-supported cabinets offer up to 1000 lb (453.6 kg) static load rating

## Open Mounting



## Wall-Mounted Products

Available in open and enclosed systems, wall-mounted racks and cabinets are an excellent choice to support equipment when floor space is limited or where a small group of users exist.

Open wall-mount racks present easy access to cables and equipment and offer both fixed and swing frames. Swing frames pivot open on one side to provide access to the rear of equipment and are used to support patch panels, while fixed frames hold more weight and are used for network routers and switches.

## Enclosed Mounting



Enclosed wall-mount cabinets provide added physical security and are available in vertical, hinged and floor-supported designs. Vertical cabinets hold equipment against the wall to minimize the depth of the cabinet. Use vertical cabinets to support a small group of network users. Hinged cabinets provide access to the front and the rear of equipment. The cabinet body is hinged near the wall and can swing open to access cable terminations and the rear of equipment. Floor-supported cabinets are also hinged, but the cabinet body is supported from the floor with casters. This type of cabinet can hold more weight than wall-mounted hinged cabinets and are used to replace a freestanding rack in small rooms where added equipment security is required.

## Product Comparison

Open Systems		
Product	Purpose	Load Rating - lb
Universal Swing Gate Wall Rack Page 10-4	Feature rich, swing frame used to support network equipment for a medium size group of users	Up to 150 (68.0)
Standard Swing Gate Wall Rack Page 10-5	General use, swing frame used to support network equipment for a medium size group of users. UL Listed	Up to 150 (68.0)
EasySwing Wall-Mount Rack Page 10-6	Affordable, swing frame used to support network equipment for a small group of users. Ships pre-assembled	Up to 85 (38.6)
Heavy-Duty Wall-Mount Equipment Rack Page 10-7	Strong, fixed frame used to support network equipment for a medium size group of users and other heavy equipment	Up to 350 (158.8)
Fixed Wall-Mount Equipment Rack Page 10-8	Basic, fixed frame used to support network equipment for a small group of users. UL Listed	Up to 200 (90.7)
Enclosed Systems		
Cube-iT Plus® Wall-Mount Cabinet Page 10-11	Feature rich, hinged cabinet used to secure network connections for a medium size group of users. Five-inch deep rear panel allows conduit to terminate at back of cabinet. UL Listed	Up to 200 (90.7)
Cube-iT Plus® Floor-Supported Cabinet Page 10-13	Feature rich, hinged and floor-supported wall cabinet replaces floor supported network equipment in small equipment rooms	Up to 1000 (453.6)
ThinLine II Wall-Mount Cabinet Page 10-16	Space-saving cabinet used to secure network connections for a small group of users. Ideal for high-traffic areas	Up to 100 (45.4)
Silver Frame Wall-Mount Cabinet Page 10-18	Mid-level, hinged cabinet used to secure network connections for a medium size group of users	Up to 150 (68.0)

# SWING GATE WALL-MOUNT RACKS

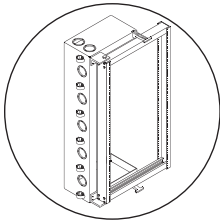

## Universal Swing Gate Rack

This full-featured swing gate rack offers 150 lb (68.0 kg) load handling capacity, easy assembly and built-in cable management capabilities.

- Dual locking latches keep gate securely closed
- Improved cable management with nine cable pass-through ports and six Saf-T-Grip® reusable Velcro® strips
- Gate opens 180°, made of strong, lightweight aluminum
- Easy assembly using included instructions
- Universal 5/8"-5/8"-1/2" (15.9 mm -15.9 mm -12.7 mm) alternating mounting hole pattern drilled on both front and back sides
- Rack-mount spaces are marked and numbered
- (50) #12-24 mounting screws included. Black painted racks ship with black screws; other racks ship with zinc screws
- Supports 150 lb (68.0 kg) of equipment when securely mounted to wall

Universal Swing Gate Rack							
Part Number	Usable Dimensions			Overall Dimensions - in (mm)			Shipping Weight lb (kg)
	Height	Width	Depth	Height	Width	Depth	
11347-X19	20U	19"EIA	12 (300)	40.4 (1026)	22.1 (562)	12.8 (325)	24 (10.9)
11348-X19	20U	19"EIA	18 (457)	40.4 (1026)	22.1 (562)	18.8 (478)	29 (13.2)
11347-X23	20U	23"	12 (300)	40.4 (1026)	26.1 (663)	12.8 (325)	25 (11.3)
11348-X23	20U	23"	18 (457)	40.4 (1026)	26.1 (663)	18.8 (478)	30 (13.6)

X=color: 1=Gray, 2=Computer Beige, 5=Clear, 7=Black, E=Glacier White.





- Dual hinges open to right or left, stopping in 90° position
- EIA-310-D compliant
- Universal 5/8"-5/8"-1/2" (15.9 mm -15.9 mm -12.7 mm) alternating hole pattern
- Rack-mount spaces are marked and numbered
- Includes (50) #12-24 mounting screws. Black painted racks ship with black screws; other racks ship with zinc screws
- Supports 100 lb (45.4 kg) of equipment in the open and closed position when securely mounted
- Load capacity can be increased to 150 lb (68 kg) with optional Heavy Duty Swing Gate Kit
- Supports single-sided and double-sided shelves
- Ships partially assembled with installation hardware

## Standard Swing Gate Wall Rack

The Standard Swing Gate Wall Rack provides easy access to the rear of equipment, making it the ideal choice for supporting patch panels and switches.

Standard Swing Gate Wall Rack							
Part Number	Usable Dimensions			Overall Dimensions - in (mm)			Shipping Weight lb (kg)
	Height	Width	Depth	Height	Width	Depth	
11790-X12	12U	19"EIA	11 (280)	29.1 (739)	21.7 (551)	12.2 (310)	22 (10.0)
11790-X18	12U	19"EIA	17 (430)	29.1 (739)	21.7 (551)	18.2 (462)	24 (10.9)
11790-X25	12U	19"EIA	24 (610)	29.1 (739)	21.7 (551)	25.2 (640)	42 (19.1)
11791-X12	20U	19"EIA	11 (280)	43.1 (1095)	21.7 (551)	12.2 (310)	24 (10.9)
11791-X18	20U	19"EIA	17 (430)	43.1 (1095)	21.7 (551)	18.2 (462)	26 (11.8)
11791-X25	20U	19"EIA	24 (610)	43.1 (1095)	21.7 (551)	25.2 (640)	46 (20.9)
11807-X12	26U	19"EIA	11 (280)	53.6 (1361)	21.7 (551)	12.2 (310)	25 (11.3)
11807-X18	26U	19"EIA	17 (430)	53.6 (1361)	21.7 (551)	18.2 (462)	26 (11.8)
11807-X25	26U	19"EIA	24 (610)	53.6 (1361)	21.7 (551)	25.2 (640)	50 (22.7)
11792-X12	40U	19"EIA	11 (280)	78.1 (1984)	21.7 (551)	12.2 (310)	31 (14.1)
11792-X18	40U	19"EIA	17 (430)	78.1 (1984)	21.7 (551)	18.2 (462)	33 (15.0)
11792-X25	40U	19"EIA	24 (610)	78.1 (1984)	21.7 (551)	25.2 (640)	60 (27.2)
11793-X12	12U	23"	11 (280)	29.1 (739)	25.7 (653)	12.2 (310)	23 (10.4)
11793-X18	12U	23"	17 (430)	29.1 (739)	25.7 (653)	18.2 (462)	25 (11.3)
11793-X25	12U	23"	24 (610)	29.1 (739)	25.7 (653)	25.2 (640)	43 (19.5)
11794-X12	20U	23"	11 (280)	43.1 (1095)	25.7 (653)	12.2 (310)	25 (11.3)
11794-X18	20U	23"	17 (430)	43.1 (1095)	25.7 (653)	18.2 (462)	27 (12.2)
11794-X25	20U	23"	24 (610)	43.1 (1095)	25.7 (653)	25.2 (640)	47 (21.3)
11808-X12	26U	23"	11 (280)	53.6 (1361)	25.7 (653)	12.2 (310)	26 (11.8)
11808-X18	26U	23"	17 (430)	53.6 (1361)	25.7 (653)	18.2 (462)	28 (12.7)
11808-X25	26U	23"	24 (610)	53.6 (1361)	25.7 (653)	25.2 (640)	51 (23.1)
11795-X12	40U	23"	11 (280)	78.1 (1984)	25.7 (653)	12.2 (310)	32 (14.5)
11795-X18	40U	23"	17 (430)	78.1 (1984)	25.7 (653)	18.2 (462)	34 (15.4)
11795-X25	40U	23"	24 (610)	78.1 (1984)	25.7 (653)	25.2 (640)	61 (27.7)

X=Color: 1=Gray, 2=Computer Beige, 7=Black, E=Glacier White

Note: Usable Depth is reduced at the top and bottom U to 8" (200 mm) pm -X12;

12" (300 mm on -X18; and 19" (462 mm) on -X25 racks.

## Heavy Duty Swing Gate Kit

Increases the load bearing capacity of P/Ns (-X18) and (-X25) Standard Swing Gate Wall Racks to 150 lb (68 kg). Hardware included.



Part Number	Description	Shipping Weight lb (kg)
12795-X01	Two Brackets	4 (1.8)

X=Color: 1=Gray, 2=Computer Beige, 7=Black, E=Glacier White.



Ships flat

## EasySwing Wall-Mount Rack

The EasySwing Wall-Mount Rack is a cost-effective 19" EIA swing gate rack for mounting network, communications and security equipment in a telecommunications or equipment room where floor space is limited.

- Opens 180° to right or left, locking latch pin secures gate in closed position. Includes lanyard for attachment to rack
- 19" EIA threaded equipment mounting rails
- Includes reusable cable management straps
- Durable all-steel construction
- Ships fully assembled and flat; simply unfold and mount to wall
- Keyhole wall mounting holes with mounting template included on carton
- Includes (12) #12-24 equipment mounting screws. Order 1/4" installation hardware separately
- Supports 85 lb (38.6 kg) of equipment

Easy Swing Wall-Mount Rack							
Part Number	Usable Dimensions			Overall Dimensions - in (mm)			Shipping Weight lb (kg)
	Height	Width	Depth	Height	Width	Depth	
13602-X08	11U	19"EIA	6.5 (165)	24.5 (622)	20.3 (516)	8.0 (204)	22 (10.0)
13602-X12	11U	19"EIA	10.5 (266)	24.5 (622)	20.3 (516)	12.0 (305)	24 (10.9)
13602-X18	11U	19"EIA	16.5 (419)	24.5 (622)	20.3 (516)	18.0 (457)	28 (12.7)
13602-X25	11U	19"EIA	23.5 (596)	24.5 (622)	20.3 (516)	25.0 (635)	34 (15.4)
13604-X08	19U	19"EIA	6.5 (165)	38.5 (978)	20.3 (516)	8.0 (204)	27 (12.2)
13604-X12	19U	19"EIA	10.5 (266)	38.5 (978)	20.3 (516)	12.0 (305)	29 (13.2)
13604-X18	19U	19"EIA	16.5 (419)	38.5 (978)	20.3 (516)	18.0 (457)	33 (15.0)
13604-X25	19U	19"EIA	23.5 (596)	38.5 (978)	20.3 (516)	25.0 (635)	38 (17.2)
13608-X12	26U	19"EIA	10.5 (266)	51.5 (1308)	20.3 (516)	12.0 (305)	33 (15.0)
13608-X18	26U	19"EIA	16.5 (419)	51.5 (1308)	20.3 (516)	18.0 (457)	37 (16.8)

X=Color: 1=Gray, 2=Computer Beige, 7=Black, E=Glacier White

Note: Usable Depth is reduced at the top and bottom 2U on -X08 and -X12 models and at the top and bottom 3U on -X18 and -X25 models. For planning purposes, reduce Usable Depth by 75% and 50% on the top and bottom 2U of -X08 and -X12 racks. Reduce Usable Depth by 80%, 50% and 25% on the top and bottom 3U of -X18 and -X25 racks.

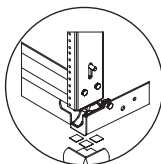
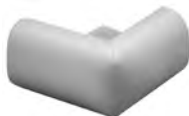

Includes double-sided adhesive squares for easy installation

## Corner Cushions

Since wall racks are elevated above the floor and extend away from the wall, bumping into the rack is a safety concern. Corner Cushions cover the exposed leading edges of racks for added protection.

- Flame retardant, non-toxic
- Foam design conforms to ASTM standards for safety surfacing material

Part Number	Description	Shipping Weight lb (kg)
12858-001	Corner Cushions, Set of 4	1 (0.5)

## Heavy Duty Wall-Mount Equipment Rack

Use the Heavy Duty Wall-Mount Equipment Rack to hold up to 350 lb (158.8 kg). The 24" (610 mm) depth allows larger equipment to be wall-mounted. Quick and easy assembly has been engineered in to save you valuable installation time.

Includes assembly hardware and mounting 1/4" x 2" lag bolts. Sold individually.

- 12-24 roll-formed threads on 5/8"-5/8"-1/2" (15.9 mm -15.9 mm -12.7 mm) spacing, both sides
- Rack-mount spaces are marked and numbered
- Made of high-strength, lightweight aluminum
- Includes (50) #12-24 mounting screws. Black painted racks ship with black screws; other racks ship with zinc screws
- Holds up to 350 lb (158.8 kg) when securely mounted to wall or backboard



### Easy Swing Wall-Mount Rack

Part Number	Usable Dimensions			Overall Dimensions - in (mm)			Shipping Weight lb (kg)
	Height	Width	Depth	Height	Width	Depth	
15320-X18	20U	19"EIA	18 (457)	41.2 (1046)	23.0 (584)	18.0 (457)	22 (10.0)
15320-X24	20U	19"EIA	24 (610)	41.2 (1046)	23.0 (584)	24.0 (610)	27 (12.2)
15321-X18	40U	19"EIA	18 (457)	76.2 (1935)	23.0 (584)	18.0 (457)	28 (12.7)
15321-X24	40U	19"EIA	24 (610)	76.2 (1935)	23.0 (584)	24.0 (610)	32 (14.5)
15322-X18	20U	23"	18 (457)	41.2 (1046)	27.0 (686)	18.0 (457)	23 (10.4)
15322-X24	20U	23"	24 (610)	41.2 (1046)	27.0 (686)	24.0 (610)	29 (13.2)
15323-X18	40U	23"	18 (457)	76.2 (1935)	27.0 (686)	18.0 (457)	29 (13.2)
15323-X24	40U	23"	24 (610)	76.2 (1935)	27.0 (686)	24.0 (610)	34 (15.4)

X=color: 1=Gray, 2=Computer Beige, 5=Clear, 7=Black, E=Glacier White

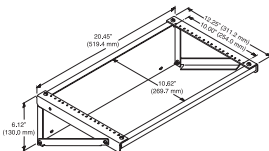

## Extra-Capacity, Flush Mounted Wall Bracket

This rack is used to mount up to 6U of rack-mount equipment flush to the wall.

Ideal for small or tight spaced installations. Supports 150 lb (68 kg). Mounting hardware not included. Made of strong, lightweight aluminum.

Part Number	Description
11754-X19	6U x 19 Wall Bracket

X=color: 1=Gray, 2=Computer Beige, 5=Clear, 7=Black, E=Glacier White



## Fixed Wall-Mount Equipment Rack

The Fixed Wall-Mount Equipment Rack is a sturdy platform for wall mounting equipment.

- EIA-310-D compliant equipment mounting system, punched with the Universal alternating 5/8"-5/8"-1/2"(15.9 mm -15.9 mm -12.7 mm) hole pattern
- Rack-mount spaces are marked and numbered, tapped with #12-24 roll-formed threads
- Includes (50) #12-24 equipment mounting screws. Black painted racks ship with black screws; other racks ship with zinc screws
- Supports single-sided and double-sided shelves
- Supports 200 lb (90.7 kg) of equipment when securely mounted to wall or backboard using all eight leg mounting holes

Fixed Wall-Mount Equipment Rack							
Part Number	Usable Dimensions			Overall Dimensions - in (mm)			Shipping Weight lb (kg)
	Height	Width	Depth	Height	Width	Depth	
11960-X06	12U	19"EIA	6 (150)	27.4 (696)	22.4 (569)	6.6 (168)	9 (4.1)
11960-X12	12U	19"EIA	12 (300)	27.4 (696)	22.4 (569)	12.6 (320)	12 (5.4)
11960-X18	12U	19"EIA	18 (457)	27.4 (696)	22.4 (569)	18.6 (472)	13 (5.9)
11961-X06	20U	19"EIA	6 (150)	41.4 (1052)	22.4 (569)	6.6 (168)	10 (4.5)
11961-X12	20U	19"EIA	12 (300)	41.4 (1052)	22.4 (569)	12.6 (320)	13 (5.9)
11961-X18	20U	19"EIA	18 (457)	41.4 (1052)	22.4 (569)	18.6 (472)	15 (6.8)
11962-X06	40U	19"EIA	6 (150)	76.4 (1941)	22.4 (569)	6.6 (168)	15 (6.8)
11962-X12	40U	19"EIA	12 (300)	76.4 (1941)	22.4 (569)	12.6 (320)	16 (7.3)
11962-X18	40U	19"EIA	18 (457)	76.4 (1941)	22.4 (569)	18.6 (472)	20 (9.1)
11963-X06	12U	23"	6 (150)	27.4 (696)	26.4 (671)	6.6 (168)	10 (4.5)
11963-X12	12U	23"	12 (300)	27.4 (696)	26.4 (671)	12.6 (320)	11 (5.0)
11963-X18	12U	23"	18 (457)	27.4 (696)	26.4 (671)	18.6 (472)	13 (5.9)
11964-X06	20U	23"	6 (150)	41.4 (1052)	26.4 (671)	6.6 (168)	11 (5.0)
11964-X12	20U	23"	12 (300)	41.4 (1052)	26.4 (671)	12.6 (320)	12 (5.4)
11964-X18	20U	23"	18 (457)	41.4 (1052)	26.4 (671)	18.6 (472)	15 (6.8)
11965-X06	40U	23"	6 (150)	76.4 (1941)	26.4 (671)	6.6 (168)	16 (7.3)
11965-X12	40U	23"	12 (300)	76.4 (1941)	26.4 (671)	12.6 (320)	17 (7.7)
11965-X18	40U	23"	18 (457)	76.4 (1941)	26.4 (671)	18.6 (472)	19 (8.6)

X=color: 1=Gray, 2=Computer Beige, 5=Clear, 7=Black, E=Glacier White

Note: Corner Cushions available on page 10-6.



## Wall-Mount Rack With Enclosure

Enjoy the benefits of a wall-mount rack solution with the added protection and security of an enclosure at an attractive price. As always, CPI quality is built into this economical product. So, whenever floor space is at a premium and a full size rack is not required, use the CPI Wall-Mount Rack with Enclosure. Available in two sizes with aluminum or plexiglass doors. Ships fully assembled with mounting instructions and hardware.

### Rack Features:

- Strong, lightweight aluminum construction provides maximum strength
- Includes wall-mounting 1/4" x 2" lag bolts and 50 #12-24 mounting screws. Black painted racks ship with black screws; other racks ship with zinc screws
- 19"EIA, Universal 5/8" -5/8"-1/2" (15.9 mm x 15.9 mm x 12.7 mm) hole pattern allows for a wide variety of mounting options
- Supports up to 200 lb (90.7 kg)

### Enclosure Features:

- Strong, lightweight aluminum construction
- Vented top and bottom for optimum airflow
- Convenient cable access via removable two top and two bottom cable pass-through ports, 1.6" x 3.5" (41 mm x 89 mm)
- Lockable door is easily installed to open from left or right
- Optional Fan Kit available for 18"D (460 mm) enclosure

Wall-Mount Rack With Enclosure							
Part Number	Usable Dimensions			Overall Dimensions - in (mm)			Shipping Weight lb (kg)
	Height	Width	Depth	Height	Width	Depth	
12264-X16	12U	19"EIA	12 (300)	28.5 (724)	24.5 (622)	16.1 (409)	44 (20.0)
12324-X22	20U	19"EIA	18 (457)	42.1 (1069)	24.5 (622)	22.1 (561)	60 (27.2)
Includes Door With Tinted Plexiglass Window							
12265-X16	12U	19"EIA	12 (300)	28.5 (724)	24.5 (622)	16.1 (409)	44 (20.0)
12325-X22	20U	19"EIA	18 (457)	42.1 (1069)	24.5 (622)	22.1 (561)	60 (27.2)

X=color: 1=Gray, 2=Computer Beige, 7=Black

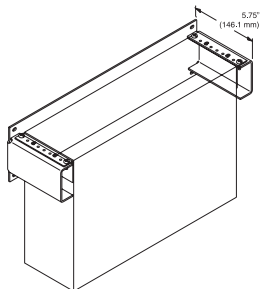

## Flush Mounted Wall Bracket

This bracket makes it easy to mount up to three 1U pieces (3 RMU) of rack-mount equipment (1U=1.75", 44.45 mm) flush to a wall. Ideal for small or tight spaced installations. Mounting hardware not included. Made of strong, lightweight aluminum.

- Supports up to 75 lb (34 kg)
- Note: This wall bracket is not rack-mountable.

Part Number	
19" Rack	23" Rack
11583-X19	11583-X23

X=color: 1=Gray, 2=Computer Beige, 5=Clear, 7=Black, E=Glacier White

# WALL-MOUNT RACK ACCESSORIES

2U

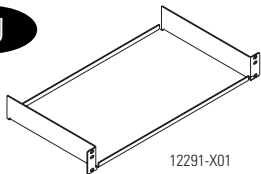

12291-X01

3U

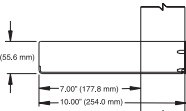

40074-X00

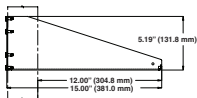

11755-003



1U



See Section 1 for additional shelf options.  
See Section 7 for additional power options.

## Shelves

- 15" (380 mm) shelf mounts in 18"D (460 mm) racks only

Part Number	Description	Shipping Weight lb (kg)
<b>10"D (250 mm) Shelf, H x W - in (mm)</b>		
12291-X01	2U x 17.25 (438.2), Supports 40 lb (18.1 kg)	4 (1.8)
<b>15"D (380 mm) Shelf, H x W - in (mm)</b>		
40074-X00	3U x 17.25 (438.2), Supports 50 lb (22.7 kg)	6 (2.7)

X=color: 1=Gray, 2=Computer Beige, 5=Clear, 7=Black, E=Glacier White

## Fan/Filter Kit

Fan pressurizes enclosure, forcing warmer air out top vents. Fan is rated for 200 CFM and has an attached 5'6"L (1.6 m) power cord with NEMA 5-15P plug (37 dB noise level).

Part Number	Description	Shipping Weight lb (kg)
11755-003	200 CFM, 115 VAC, 50/60 Hz, NEMA 5-15P	3 (1.4)
11222-001	Replacement Filters, Set of 4	1 (0.5)

## Power Strip

Streamlined, durable steel body is fitted with bracket for mounting.

- 17" L (430 mm), uses 1U, black
- Circuit breaker, six or eight outlets, non-surge or surge-protected, 10' (3 m) cord

Part Number	AMP	Plug Type	Outlets	Surge Protected
12816-701	15A	NEMA 5-15P	(8) 5-15R	No
12816-702	15A	NEMA L5-15P	(8) 5-15R	No
12816-703	15A	NEMA 5-15P	(6) 5-15R	Yes
12816-704	15A	NEMA L5-15P	(6) 5-15R	Yes
12816-705	20A	NEMA 5-20P	(8) 5-20R	No
12816-706	20A	NEMA L5-20P	(8) 5-20R	No
12816-707	20A	NEMA 5-20P	(6) 5-20R	Yes
12816-708	20A	NEMA L5-20P	(6) 5-20R	Yes



Wall-Mounted  
Cube-IT Plus



Wall-Mounted, Floor-Supported  
Cube-IT Plus Cabinet

## CUBE-IT plus® Cabinet System

The patented Cube-IT Plus Cabinet System is a series of wall-mounted and floor-supported telecommunications enclosures designed to secure communications equipment for a cross connect. The cabinets are copper and fiber ready and feature easy access to the front or rear of the cabinet.

Both the wall-mounted and floor-supported cabinets share these features:

- Swing-gate cabinet body enables easy access to the rear of installed equipment
- 5"D (130 mm) rear panel is pre-punched with knock-outs for 1/2", 3/4", 2-1/2" and 3" conduit and has cable tie points and attachment points for accessory rack-mount brackets
- Cabinet body includes one pair of adjustable 19" EIA threaded equipment rails
- Cabinet body is vented, vents will accept accessory fan
- Front door design incorporates rounded edges and corners to improve safety in public access spaces
- A locking front door and rear panel provide security
- Wide variety of accessories are available



Patented



Wall-Mounted Cube-IT Plus

## CUBE-IT Wall-Mounted Cabinet Specifications

### 24"H, 36"H & 48"H Cabinets (610 mm, 910 mm & 1220 mm)

- Patented hinge design allows the installer to remove the rear panel for easy installation
- For indoor use only, not for use in air-handling spaces
- Usable heights: 24"H (610 mm) = 12U; 36"H (910mm) = 18U; 48"H (1220 mm) = 26U
- Includes one pair of 19"W adjustable (front-to-rear) mounting rails with Universal 5/8"-5/8"-1/2" (15.9 mm-15.9 mm -12.7 mm) alternating hole pattern. EIA-310-D Compliant; front rails are threaded for #12-24 mounting screws
- Cable knockouts include: (4) 1/2" or 3/4", two on top, two on bottom; (8) 2-1/2" or 3", four on top, four on bottom; (4) edge-protection grommets are included for 3" knockouts
- Constructed of riveted and bolted steel with epoxy-polyester hybrid powder coat paint finish. Equipment mounting rails are aluminum
- Ships fully assembled with mounting hardware, 50 each #12-24 screws and installation template
- UL Listed to support up to 200 lb (90.7 kg)

Only Wall-Mounted Cabinets are UL Listed.

Depths for Wall-Mounted Cabinet in (mm)				
Cabinet Depth	13 (330)	18 (460)	24 (610)	30 (760)
Cabinet Body Depth	7.2 (18)	12.2 (310)	18.2 (462)	24.2 (615)
Maximum Usable Depth	11.8 (300)	16.8 (427)	22.8 (579)	28.8 (732)

# CUBE-IT PLUS® CABINET SYSTEM

24" H (610 mm) Cube-IT Plus - Wall Mounted					
Part Number & Color		Door Style	Width in (mm)	Depth in (mm)	Shipping Weight lb (kg)
Computer Beige	Black				
13265-224	13265-724	Metal Door	24 (610)	13 (330)	70 (31.8)
13275-224	13275-724	Plexiglass Door	24 (610)	13 (330)	67 (30.4)
11890-224	11890-724	Metal Door	24 (610)	18 (460)	78 (35.4)
11901-224	11901-724	Plexiglass Door	24 (610)	18 (460)	75 (34.0)
11840-224	11840-724	Metal Door	24 (610)	24 (610)	87 (39.5)
11900-224	11900-724	Plexiglass Door	24 (610)	24 (610)	84 (38.1)
11996-224	11996-724	Metal Door	24 (610)	30 (760)	97 (44.0)
12419-224	12419-724	Plexiglass Door	24 (610)	30 (760)	94 (42.6)
Extra Mounting Rails, 1 pair					
12787-524	L-Shaped, Threaded, 12U				3 (1.4)
36" H (910 mm) Cube-IT Plus - Wall Mounted					
Part Number & Color		Door Style	Width in (mm)	Depth in (mm)	Shipping Weight lb (kg)
Computer Beige	Black				
13265-236	13265-736	Metal Door	24 (610)	13 (330)	89 (40.4)
13275-236	13275-736	Plexiglass Door	24 (610)	13 (330)	83 (37.6)
11890-236	11890-736	Metal Door	24 (610)	18 (460)	99 (44.9)
11901-236	11901-736	Plexiglass Door	24 (610)	18 (460)	93 (42.2)
11840-236	11840-736	Metal Door	24 (610)	24 (610)	111 (50.3)
11900-236	11900-736	Plexiglass Door	24 (610)	24 (610)	105 (47.6)
11996-236	11996-736	Metal Door	24 (610)	30 (760)	124 (56.2)
12419-236	12419-736	Plexiglass Door	24 (610)	30 (760)	118 (53.5)
Extra Mounting Rails, 1 Pair					
12787-536	L-Shaped, Threaded, 18U				4 (1.8)
48" H (1220 mm) Cube-IT Plus - Wall Mounted					
Part Number & Color		Door Style	Width in (mm)	Depth in (mm)	Shipping Weight lb (kg)
Computer Beige	Black				
13265-248	13265-748	Metal Door	24 (610)	13 (330)	108 (49.0)
13275-248	13275-748	Plexiglass Door	24 (610)	13 (330)	101 (45.8)
11890-248	11890-748	Metal Door	24 (610)	18 (460)	121 (54.9)
11901-248	11901-748	Plexiglass Door	24 (610)	18 (460)	114 (51.7)
11840-248	11840-748	Metal Door	24 (610)	24 (610)	135 (61.2)
11900-248	11900-748	Plexiglass Door	24 (610)	24 (610)	128 (58.1)
11996-248	11996-748	Metal Door	24 (610)	30 (760)	151 (68.5)
12419-248	12419-748	Plexiglass Door	24 (610)	30 (760)	143 (64.9)
Extra Mounting Rails, 1 Pair					
12787-548	L-Shaped, Threaded, 26U				5 (2.3)
Floor-Mount Foot Kit					
13483-001	Foot Kit for 24" D (610 mm) & 30" D (760 mm) Cabinets Only				5 (2.3)

*Note: Foot Kit allows front door and rear panel to open when cabinet is placed on the floor, shelf or other surface.*





Wall-Mounted, Floor-Supported Cube-IT Plus Cabinet

## CUBE-IT Wall-Mounted, Floor-Supported Cabinet Specifications

60" H & 72" H Cabinets (1520 mm & 1830 mm)

- Cabinet body features lockable front door and swing-gate rear panel for easy equipment access; cabinet body is supported by an attached wheel base
- For indoor use only, not for use in air-handling spaces
- Usable heights: 60" H (1520 mm) = 33U; 72" H (1830 mm) = 40U
- Wheeled base adds an additional 6" (150 mm) to height
- Includes one pair of 19"W adjustable (front-to-rear) mounting rails with Universal 5/8"-5/8"-1/2" (15.9 mm -15.9 mm -12.7 mm) alternating hole pattern; EIA-310-D Compliant
- Includes cable management space for vertical cable manager accessory
- Cable knockouts include: (4) 1/2" or 3/4", two on top, two on bottom; (10) 2-1/2" or 3", five on top, five on bottom; (5) edge-protection grommets are included for 3" knockouts
- Constructed of riveted and bolted steel with epoxy-polyester hybrid powder coat paint finish; equipment mounting rails and supports are aluminum
- Ships fully assembled with mounting hardware
- Supports up to 1000 lb (453.6 kg)

60" H (1520 mm) Cube-IT Plus - Wall Mounted & Floor-Supported					
Part Number & Color		Door Style	Width in (mm)	Depth in (mm)	Shipping Weight lb (kg)
Computer Beige	Black				
13491-260	13491-760	Metal Door	27.3 (693)	18 (460)	201 (91.2)
13494-260	13494-760	Plexiglass Door	27.3 (693)	18 (460)	192 (87.1)
13492-260	13492-760	Metal Door	27.3 (693)	24 (610)	221 (100.2)
13495-260	13495-760	Plexiglass Door	27.3 (693)	24 (610)	212 (96.2)
13493-260	13493-760	Metal Door	27.3 (693)	30 (760)	246 (111.6)
13496-260	13496-760	Plexiglass Door	27.3 (693)	30 (760)	236 (107.0)
Extra Mounting Rails, 1 pair					
13276-260	13276-760	L-Shaped, Threaded, 33U			12 (5.4)
72" H (1830 mm) Cube-IT Plus - Wall Mounted & Floor-Supported					
Part Number & Color		Door Style	Width in (mm)	Depth in (mm)	Shipping Weight lb (kg)
Computer Beige	Black				
13491-272	13491-772	Metal Door	27.3 (693)	18 (460)	224 (101.6)
13494-272	13494-772	Plexiglass Door	27.3 (693)	18 (460)	212 (96.2)
13492-272	13492-772	Metal Door	27.3 (693)	24 (610)	247 (112.0)
13495-272	13495-772	Plexiglass Door	27.3 (693)	24 (610)	235 (106.6)
13493-272	13493-772	Metal Door	27.3 (693)	30 (760)	274 (124.3)
13496-272	13496-772	Plexiglass Door	27.3 (693)	30 (760)	262 (118.8)
Extra Mounting Rails, 1 pair					
13276-272	13276-772	L-Shaped, Threaded, 40U			14 (6.4)
Depths for Wall-Mounted, Floor-Supported Cabinet – in (mm)					
Cabinet Depth			18 (460)	24 (610)	30 (760)
Cabinet Body Depth			12.2 (310)	18.2 (462)	24.2 (615)
Maximum Usable Depth			16.8 (427)	22.8 (579)	28.8 (732)



12804-701



12805-X01



12803-701



13287-501

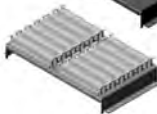

13288-501



Vertical Cable Managers listed here are for Cube-iT Plus Cabinets only.  
13485-760; for 60" H (1520 mm)  
13485-772; for 72" H (1830 mm)



11837-X01

## Cube-iT PLUS® Accessories

### Fan Kit

Attaches over the vents in the side of the Cube-iT Plus Cabinet. Draws air into the cabinet, pressurizing the cabinet and forcing warm air out of the side vents. Fan Filter Kit reduces dust and can be mounted internally for security or externally for convenience; filter kit and filters sold separately. Includes mounting hardware and cable ties. Available in 115 VAC, 50/60 Hz, 37 dB Fan with 5'L (1.5 m) attached power cord and NEMA 5-15 plug; and 230 VAC, 50/60 Hz, 37 dB Fan with 5'L (1.5 m) attached power cord and NEMA 6-15P plug.

### Light

Light attaches to the bottom, top or side of cabinet and provides 8 Watts of fluorescent light with on/off switch. 115 VAC with 6' (1.8 m) attached power cord and NEMA 5-15P plug. 1U rack-mount version also available.

### Termination Block Panel

Attaches to rear panel of Cube-iT Plus Cabinet. Supports six 110D-style 100-pair blocks or four 66-style blocks/H89D brackets. Clear finish.

### Vertical Cable Manager

Vertical Cable Managers can be used in 60"H (1520 mm) and 72"H (1830 mm) cabinets only. Openings align with rack-mount units, 2.7"W x 5"D (69 mm x 130 mm) usable interior space. Adjusts front-to-rear within cabinet; fingers manage patch cords. Must be installed before rack-mount equipment.

### Horizontal Wire Management Bar

Attaches to the rear of the equipment mounting rail to secure premise cables after termination on patch panels. Includes mounting hardware and 12 cable ties.

Part Number	Description	Shipping Weight lb (kg)
12804-701	Fan Kit, 100 CFM, 115 VAC, 50/60 Hz, NEMA 5-15P	4 (1.8)
12804-702	Fan Kit, 100 CFM, 230 VAC, 50/60 Hz, NEMA 6-15P	4 (1.8)
12805-X01	Filter Kit for Fan	4 (1.8)
12806-001	Filters for Fan, Box of 6	1 (0.5)
12803-701	Light	3 (1.4)
13287-501	Termination Block Panel 11.5 x 19 (292 x 480 mm), 66 Block	4 (1.8)
13288-501	Termination Block Panel 11.5 x 19 (292 x 480 mm), 110 Block	4 (1.8)
13485-760	Cable Manager for 60 (1520) Cabinet	9 (4.1)
13485-772	Cable Manager for 72 (1830) Cabinet	10 (4.5)
11837-X01	Horizontal Wire Management Bar	2 (0.9)

X=color: 2=Computer Beige, 7=Black

3U



12796-501

2U



13285-501

2U

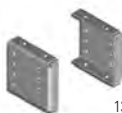

13286-501

3U



13286-502



12820-701

2U

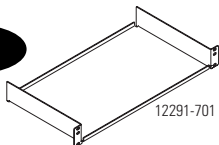

12291-701

3U

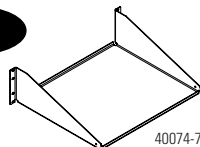

40074-700

## Cube-iT PLUS® Accessories

### 45° Mounting Bracket

Attaches to rear panel to create a 3U x 19" EIA rack-mount space for patch panels. Includes installation hardware.

### 90° Mounting Bracket

Attaches to rear panel to create a 2U x 19" EIA vertical rack-mount space. Includes installation hardware.

### Vertical Mounting Bracket

Attaches to the equipment mounting rail and creates a 2U x 19" EIA or 3U x 19" vertical rack-mount space. Includes installation hardware. Supports 75 lb (34 kg).

### Power Strip

Attaches to the bottom, top or side; select straight or locking plug style. 115 VAC 15 Amp or 20 Amp, 8 outlets with 10'L (3 m) power cord and circuit breaker. Optional surge-protected models with 6 outlets. Includes bracket and installation hardware.

### Shelves

Shelves mount in Cube-iT cabinets.

Part Number	Description	Shipping Weight lb (kg)
12796-501	45° Mounting Bracket, 3U, 1 Pair, Clear	3 (1.4)
13285-501	90° Mounting Bracket, 2U, 1 Pair, Clear	3 (1.4)
13286-501	Vertical Mounting Bracket, 2U, 1 Pair, Clear	3 (1.4)
13286-502	Vertical Mounting Bracket, 3U, 1 Pair, Clear	3 (1.4)
12820-701	15 Amp Power Strip, NEMA 5-15P	4 (1.8)
12820-702	15 Amp Power Strip, NEMA L5-15P	4 (1.8)
12820-703	15 Amp Power Strip, Surge-Protected, NEMA 5-15P	4 (1.8)
12820-704	15 Amp Power Strip, Surge-Protected, NEMA L5-20P	4 (1.8)
12820-705	20 Amp Power Strip, NEMA 5-20P	4 (1.8)
12820-706	20 Amp Power Strip, NEMA L5-20P	4 (1.8)
12820-707	20 Amp Power Strip, Surge-Protected, NEMA 5-20P	4 (1.8)
12820-708	20 Amp Power Strip, Surge-Protected, NEMA L5-20P	4 (1.8)
12291-X01	10"D (250 mm) Shelf 2U x 17.25 (438.2), Holds 40 lb (18.1 kg)	4 (1.8)
40074-X00	15"D (380 mm) Shelf 3U x 17.25 (438.2), Holds 50 lb (22.7 kg)	6 (2.7)

X=Color: 1=Gray, 2=Computer Beige, 5=Clear, 7=Black, E=Glacier White

Note: Surge-Protected power strips have 6 outlets; other power strips have 8 outlets.



## ThinLine II Wall-Mount Cabinet

The space-saving ThinLine II safely secures 19" rack-mount network equipment with minimal intrusion into the room — perfect for tight areas and high-traffic places, such as classrooms and retail stores.

The ThinLine II maximizes interior space using a distinctive equipment mounting rail system. Individual rails can be easily rotated for horizontal or vertical mounting and then bolted into place making patch panel punchdown easier. The cabinet can hold a server, switch, horizontal cable manager, patch panel, fiber service loop and fiber-optic patch panel — with room to accommodate additional mounting needs.

An easy-to-remove top panel slides in and out of position (without tools) using a spring button release. In addition, the 26" H (660 mm) cabinet can be mounted so that the removable "top" panel becomes a side panel.

A 4" x 6" (100 mm x 150 mm) opening in the rear of the cabinet and knockouts sized 3/4" and 1-1/2" allow cable entry and exit. Multiple cable tie-down points in rear panel and included Saf-T-Grip® straps secure cables safely.

- Door features rounded edges and corners and can be mounted to open from either right or left
- Removable top panel provides direct access to equipment without disturbing other devices
- Multiple sets of knockouts allow flexibility in cable organization
- Louvers and fan accessory provide ventilation
- Cabinet includes a 2" x 4" (50 mm x 100 mm) junction box to hold an optional surge-suppressed duplex outlet, eliminating the need for a power strip
- Made of steel
- Ships fully assembled with mounting hardware
- Static load rating is 100 lb (45.4 kg)

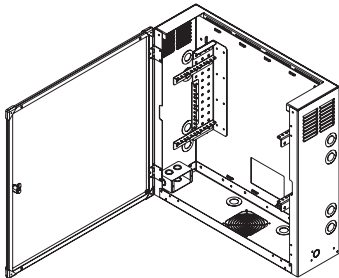

ThinLine II can hold a server, switch, horizontal cable manager, patch panel, fiber service loop and fiber-optic patch panel — with room to accommodate additional mounting needs.

Part Number	Description H x W x D in (mm)	Shipping Weight lb (kg)
<b>26" H (660 mm) ThinLine II</b>		
13050-X11	26 x 26 x 5, 2U, (660 x 660 x 130)	47 (21.3)
13050-X12	26 x 26 x 8.5, 4U, (660 x 660 x 216)	54 (24.5)
13050-X13	26 x 26 x 12, 6U, (660 x 660 x 300)	60 (27.2)
<b>36" H (910 mm) ThinLine II</b>		
13050-X21	36 x 26 x 5, 2U, (910 x 660 x 130)	60 (27.2)
13050-X22	36 x 26 x 8.5, 4U, (910 x 660 x 216)	68 (30.8)
13050-X23	36 x 26 x 12, 6U, (910 x 660 x 300)	76 (34.5)

X= color: 1=Gray, Computer Beige, 7=Black



## Fiber Slack Manager Panel

The Fiber Slack Manager Panel provides both fiber slack management and a mounting surface for a small fiber manager or fiber-optic patch panel. Secured under the outermost mounting units, the panel takes up no mounting space within the cabinet. It attaches to the cabinet with standard #12-24 rack screws (included in the ThinLine II Cabinet's hardware kit).

Part Number	Description	Color	Shipping Weight lb (kg)
12955-219	19" Rack-Mount	Computer Beige	2 (0.9)
12955-719	19" Rack-Mount	Black	2 (0.9)



## Surge-Suppressed Duplex Receptacle

The cabinet can be easily configured with two surge-suppressed outlets, eliminating the need for a power strip. ThinLine II includes an electrical junction box that can be mounted on either side of the cabinet. A 1/2" or 3/4" knockout is provided.

Part Number	Description	Shipping Weight lb (kg)
12934-001	Receptacle, 125V, 15A	2 (0.9)



13501-001

### 13051-001 Intelligent Fan Specifications:

<b>Minimum Fan Speed</b> <i>(air temp 77° or less)</i>	<b>Maximum Fan Speed</b> <i>(air temp 104° or greater)</i>
65 CFM (Free Air)	120 CFM (Free Air)
34 dB (Noise Level)	51 dB (Noise Level)

### 13051-002 Intelligent Fan Specifications:

<b>Minimum Fan Speed</b> <i>(air temp 77° or less)</i>	<b>Maximum Fan Speed</b> <i>(air temp 113° or greater)</i>
36 CFM (Free Air)	49 CFM (Free Air)
28 dB (Noise Level)	33 dB (Noise Level)

## Intelligent Fan Kit

The ThinLine II Intelligent Fan Kit uses a solid state temperature control to vary fan speed from an ultra quiet low speed at low air temperature through increasingly higher speeds as temperature rises.

Part Number	Description	Shipping Weight lb (kg)
13051-001	115 VAC, 60 Hz, 4U/6U Cabinets	2 (0.9)
13051-002	115 VAC, 60 Hz, 2U Cabinet	2 (0.9)

# SILVER FRAME WALL-MOUNT CABINET

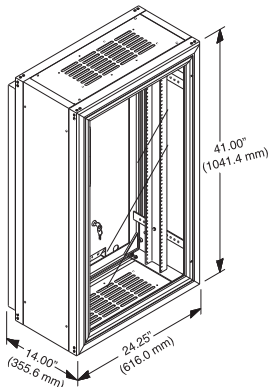

## Silver Frame Wall-Mount Cabinet

The Silver Frame Wall-Mount Cabinet provides an elegant and premium quality enclosure for protecting and securing your rack-mount equipment. Uses less space than conventional floor racks or enclosures. Unique dual-locking hinge design provides convenient front and rear access. With the 5.5" x 10.3" (140 mm x 262 mm) cable pass-through port in the center of the back panel, it is possible to route cable through the wall directly into the mounted cabinet for a more secure installation.

Rack-mounting surface depth is adjustable front to back 7-1/2" (191 mm) for 14" (360 mm) depth and 16-1/2" (419 mm) for 24" (610 mm) depth. 36" (910 mm) usable mounting height (2DU). Universal 5/8"-5/8"-1/2" (15.9 mm -15.9 mm -12.7 mm) alternating hole pattern on both front and back sides.

- Unique dual locking hinge design
- Strong, lightweight aluminum construction
- 19" rack width
- Vented top and bottom for optimum airflow
- Adjustable rack-mounting surface
- Includes (50) #12-24 mounting screws. Black painted units ship with black screws; computer beige units ship with zinc screws
- Installation hardware included: 1/4" lag screw for backboard or stud mounting and Saf-T-Grip® Cable Management Straps for cable routing
- Ships fully assembled
- Supports up to 150 lb (68 kg)

Part Number	Description H x W x D in (mm)	Shipping Weight lb (kg)
<b>Silver Frame Cabinet w/Smoked Plexiglass Doors</b>		
11680-X19	41 x 24.3 x 14 (1040 x 617 x 360)	61 (27.7)
11685-X19	41 x 24.3 x 24 (1040 x 617 x 610)	71 (32.2)
<b>Silver Frame Cabinet with Solid Metal Doors</b>		
12680-X19	41 x 24.3 x 14 (1040 x 617 x 360)	61 (27.7)
12685-X19	41 x 24.3 x 24 (1040 x 617 x 610)	71 (32.2)

X=Color: Computer Beige, 7=Black



## Fan/Filter Kit

Fan pressurizes enclosure, forcing warmer air out top vents. Fan is rated for 200 CFM and has an attached 5'6"L (1.6 m) power cord with NEMA 5-15P plug (37 dB noise level).

Part Number	Description	Shipping Weight lb (kg)
11755-003	200 CFM, 115 VAC, 50/60 Hz, NEMA 5-15P	3 (1.4)
11222-001	Replacement Filters, Set of 4	1 (0.5)

# ZONE CABLING & WIRELESS ENCLOSURES

Raised Floor, Drop Ceiling & Wall-Mount Enclosures



Zone Enclosures - Raised Floor

Page 11-4

Zone Enclosures - Drop Ceiling

Page 11-6

Zone Enclosures Service Parts

Page 11-9

Wireless Enclosures - Drop Ceiling

Page 11-10

Wireless Enclosures - Wall-Mounted

Page 11-12

# ZONE CABLING & WIRELESS ENCLOSURES

When it is time for a network to extend beyond the traditional telecommunications room, CPI Zone Cabling and Wireless Enclosures provide consolidation points that reduce the overall cost of adding or moving network cabling. Working in a partnership with American Access Technologies, Inc., the leading developer of zone cabling and wireless enclosures, CPI offers solutions that include standard-recognized zone cabling practices and several NEMA-rated models that can be used in warehouses, industrial environments and outdoors.

Available in several styles of wall-mount and drop ceiling wireless enclosures, end users are able to use CPI Zone Cabling and Wireless Enclosures to pre-wire a work area, so connections to the rest of the network are closer to network users. Pre-wiring to zone enclosures also makes future connection changes within the zone easier and less disruptive because only cables within the zone are moved, added or changed.

Wireless Enclosures offer added protection and security for wireless access points in any situation. Several models of Wireless Enclosures include locks and durable seals for exterior use, while others are able to easily blend into open office environments with dome covers that limit access to qualified technicians only.

## **CPI Zone Cabling and Wireless Enclosures feature:**

- High-quality construction and design
- Small exterior dimensions to save space in tight areas
- Secure equipment support outside of the data room
- Reduced cost of cable configurations
- Enclosed for security and safety
- UL Listed
- Suitable for low-voltage and active applications
- Can be used in air handling spaces



## Telecommunication Enclosures For Zone Cabling & Wireless Applications

In traditional cabling models, cables extend from a centralized telecommunication room to each work area. Cable changes impact the entire length of cable between the central room and the work area and can be disruptive to workers within the workspace.

In zone cabling, floor space is divided into zones (typically the area between structural building columns), and an enclosure is placed near the center of the zone to house a consolidation point. Thus, only the cable between the consolidation point and work area is impacted when a network connection is changed, reducing the amount of material, labor and workspace disruption involved in the change.

Alternately, an active component (such as a switch) can be placed within the enclosure, essentially creating a "mini-telecommunication room" within the workspace. When fiber is routed into the enclosure, an easily scalable network is created via the active component. The customer's network is thus positioned to allow fiber to the desktop when desired.

Zone cabling is an ideal solution to support networked areas with high "churn" (such as rented commercial office space, data centers, laboratories, schools, hospitals, retail operations, warehouses and industrial environments) or for use in any building that does not have planned space for a telecommunication room.

Wireless networks eliminate the need for data cabling to each user and are the best solution in large, open areas, like classrooms and meeting rooms. Wireless networks can supplement, overlay or replace traditional networks. The key to an effective wireless network is the positioning of the wireless access point to provide maximum coverage in the workspace. Once locations are defined, wireless enclosures create a secure space for the network connection and the wireless access point.

CPI offers Zone Cabling and Wireless Enclosures for use in drop ceilings, access floors and on walls. Also, a special series of wall-mount enclosures made of fiberglass are NEMA rated for use in dusty or wet environments, such as outdoors, in a warehouse or in a light industrial site (not submerged or in hazardous locations). Product applications and model information are given on the following pages.

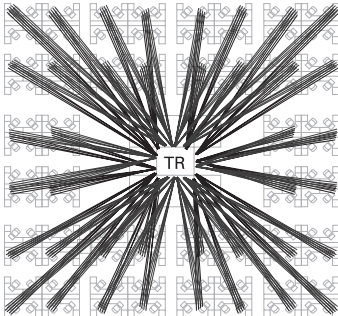

Traditional, Home Run Wiring

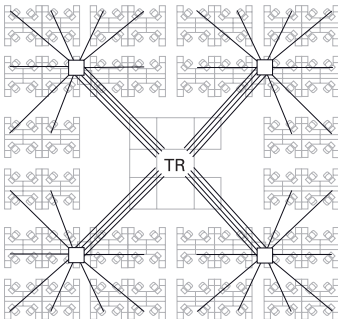

Zone Cabling

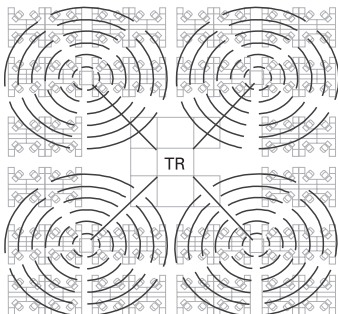

Wireless



## Raised Floor Enclosures

Raised Floor Enclosures fit under a single 2' x 2' access floor tile. Most models use the access floor tile as a "lid." Enclosures are UL Listed, suitable for low voltage and active applications and for use in air handling spaces.

A variety of sizes are available to match floor height. Most models include brackets for attachment to access floor support pedestals. Enclosures include threaded equipment mounting rails and have multiple, edge-protected cable access ports with foam sealing kits. All enclosures are finished clear.

In enclosures designed for use in low height floors, two facing pairs of pivoting equipment mounting rails are used to provide easy access to the front and rear of the patch panel. In deeper enclosures, rails that are parallel to the floor provide higher consolidation point capacity. There is also a model with a lift out tray that can support active components. Order #12-24 equipment mounting screws (P/N 40605-001) separately.

## Raised Floor Enclosures For Patch Panels

These enclosures use the access floor tile as a "lid." (All models, except A0222-RF, include access floor installation brackets.)

- A0222-RF features four cable access ports 6" x 3/4" (152 mm x 19 mm); 19" EIA threaded equipment mounting rails "pivoting"
- A0422-RF features four cable access ports 6" x 3/4" (152 mm x 19 mm); 19" EIA threaded equipment mounting rails "pivoting"
- A0622-RF features four cable access ports 6-3/4" x 2" (171 mm x 50 mm); 19" EIA threaded equipment mounting rails "pivoting"
- A0822-RF features four cable access ports 6-3/4" x 2" (171 mm x 50 mm); 19" EIA threaded equipment mounting rails "pivoting"
- 13772-001 features larger cable openings for Cat 6a cables; two ports 14-3/4" x 3-1/4" (374 mm x 82 mm) and two ports 6-1/4" x 7" (158.8 mm x 180 mm); 19" EIA threaded equipment mounting rails "pivoting"
- A1422-RF features four cable access ports 9-3/4" x 2-3/4" (247 mm x 69 mm); 19" EIA threaded equipment mounting rails "fixed"
- 13772-002 features larger cable openings for Cat 6a cables; six ports 14-3/4" x 3-1/4" (374 mm x 82 mm); 19" EIA threaded equipment mounting rails "pivoting"



A0822-RF



A1422-RF

Part Number	Description Depth in (mm)	Shipping Weight lb (kg)
A0222-RF	1U+1U Enclosure for 2 (50) Floor	10 (4.5)
A0422-RF	1U+1U Enclosure for 4 (100) Floor	10 (4.5)
A0622-RF	2U+2U Enclosure for 6 (150) Floor	23 (10.4)
A0822-RF	4U+4U Enclosure for 8 (200) Floor	23 (10.4)
13772-001	4U+4U Enclosure for 8 (200) Floor, Large Ports	25 (11.3)
A1422-RF	11U Enclosure for 14 (360) Floor	30 (13.6)
13772-002	4U+4U Enclosure for 14 (360) Floor, Large Ports	30 (13.6)



A0822-RF-F

## Raised Floor Enclosure For Fiber

Prepare your data center for future changes by pre-wiring it with fiber connections located under an access floor.

- Fits under a single 2' x 2' access floor tile
- A0822-RF-F features two 7" x 2" (180 mm x 50 mm) cable access ports and 19" EIA threaded equipment mounting rails with 4U of rack-mount space
- A1422-RF-F features two 10" x 2-1/2" cable access ports and 19" EIA threaded equipment mounting rails with 6U of rack-mount space
- Equipment mounting rails can be centered or offset in the enclosure to accommodate angled patch panels or longer electronics
- Cable tie points simplify cable management
- Includes (4) access floor support brackets

Part Number	Description Depth in (mm)	Shipping Weight lb (kg)
A0822-RF-F	4U Fiber Enclosure for 9 (230) Floor	30 (13.6)
A1422-RF-F	6U Fiber Enclosure for 14 (356) Floor	30 (13.6)



A1411-RF-HR

## Raised Floor Enclosure For Active Components

Features a lift-out tray for 2U x 10-1/4" D (260.4 mm) of active components and 5U (divided 2U - 1U - 2U) for passive connectivity.

- Includes a junction box for a duplex power outlet
- Includes fan to remove heat generated by active components

Part Number	Description Depth in (mm)	Shipping Weight lb (kg)
A1411-RF-HR	7U Enclosure for 14 (360) Floor	30 (13.6)

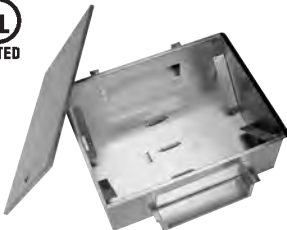

A0802-RF-DI

## Raised Floor Enclosure With Locking Cover For Patch Panels

"Drop-In" enclosure measures 21-1/4" x 22-1/4" (539.8 mm x 565.2 mm) and includes a locking cover for use completely below access floor tiles. Installation only requires the removal of one floor tile.

- Features pivoting mounting rails similar to models above and is perfect for existing data centers

Part Number	Description Depth in (mm)	Shipping Weight lb (kg)
A0802-RF-DI	4U+4U Enclosure for 9 (230) Floor	25 (11.3)

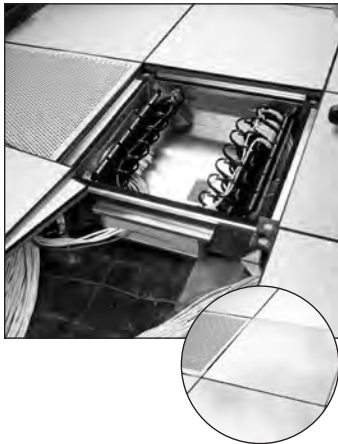

## Ceiling Enclosures

Ceiling Enclosures fit within a single 2' x 2' or 2' x 4' space, replacing a standard acoustical ceiling tile. The enclosure's face and interior are painted white and have recessed panels to support a ceiling tile, so that they blend with the drop ceiling. A fully hinged door panel with latch closures supports equipment. The door opens downward so that equipment is facing the service technician. Three door styles are available to support wiring blocks, patch panels or active components. Door locks are available as an accessory.

Ceiling Enclosures are UL Listed, suitable for low voltage and active applications and for use in air handling spaces.

- 2' x 2' enclosures support 70 lb (31.8 kg) of cables and equipment and 20 lb (9.1 kg) on the access door
- 2' x 4' enclosures support 80 lb (36.3 kg) of cables and equipment and 50 lb (22.7 kg) on the pneumatic assisted access door
- Enclosures fit in 12" H (300 mm) drop ceilings and attach to building structure with four or six 3/8" threaded rods (ordered separately)
- Includes two or four edge-protected cable access ports with fire-rated foam sealing kits



A1222-HR

## Ceiling Enclosure For Hubs, Switches And Patch Panels

Telecommunication enclosure supports a combination of active components and patch panels or other panel-mount termination hardware. Enclosures include a junction box for power and a fan to remove heat generated by active components.

- A1222-HR provides 5U for patch panels and 2U x 15"D (380 mm) for active equipment; equipment mounts on the door
- 13812-001 provides larger cable openings for Cat 6a; one 3-1/4" x 14-3/4" (82.6 mm x 374.7 mm) and one 6-1/4" x 6-7/8" (158.8 mm x 174.6 mm)
- A1024-HR provides 5U for patch panels and 2U x 15"D (380 mm) for active equipment; equipment mounts on the door
- A1224-HR provides a total of 10U with (3) brackets sized 4U - 2U - 4U to support a combination of patch panels and 15"D (380 mm) or less active equipment; brackets may be mounted on the door or the back of the enclosure
- Order #12-24 equipment mounting screws separately

Part Number	Description	Shipping Weight lb (kg)
A1222-HR	2' x 2' Ceiling Enclosure	39 (17.7)
13812-001	2' x 2' Ceiling Enclosure, Large Ports	40 (18.1)
A1024-HR	2' x 4' Ceiling Enclosure	47 (21.4)
A1224-HR	2' x 4' Ceiling Enclosure	45 (20.4)



A1222-PP



13813-001



A1224-LP

## Ceiling Enclosure For Patch Panels

Secure a consolidation point using 19" patch panels or other panel-mount termination hardware.

- A1222-PP provides a total of 5U with (3) brackets sized 2U - 1U - 2U; brackets mount on the door
- 13812-002 provides larger cable openings for Cat 6a; one 3-1/4" x 14-3/4" (82.6 mm x 374.7 mm) and one 6-1/4" x 6-7/8" (158.8 mm x 174.6 mm)
- A1024-PP provides a total of 5U with (3) brackets sized 2U - 1U - 2U; brackets mount on the door
- A1224-PP provides a total of 10U with (3) brackets sized 4U - 2U - 4U; brackets may be mounted on the door or the back of the enclosure
- Order #12-24 equipment mounting screws separately

Part Number	Description	Shipping Weight lb (kg)
A1222-PP	2' x 2' Ceiling Enclosure	38 (17.2)
13812-002	2' x 2' Ceiling Enclosure, Large Ports	39 (17.7)
A1024-PP	2' x 4' Ceiling Enclosure	43 (19.6)
A1224-PP	2' x 4' Ceiling Enclosure	45 (20.4)
13813-001	Ceiling Enclosure Fan Kit & Junction Box	3 (1.4)

*Fan Kit & Junction Box, included with 13812-001, can be installed on either 13812-002 or 13812-003 to better support active components.*

## Ceiling Enclosure For Wiring Blocks

Secure a consolidation point using wiring blocks. Enclosures include removable equipment mounting plates that can be match drilled to accommodate a wide variety of wiring blocks.

- A1222-LP has (1) mounting plate, size 13-3/4"W x 19-1/2"L (349 mm x 495 mm) for (2) 300-pair 110D (without legs) style blocks or (1) 300-pair 110A (with legs) style blocks
- 13812-003 provides larger cable openings for Cat 6a; one 3-1/4" x 14-3/4" (82.6 mm x 374.7 mm) and one 6-1/4" x 6-7/8" (158.8 mm x 174.6 mm)
- A1024-LP has (1) mounting plate, 16"W x 22"L (406 mm x 559 mm) for (2) 300-pair 110A (with legs) style blocks
- A1224-LP has (2) mounting plates, size 13-3/4"W x 19-1/2"L (349 mm x 495 mm) for (4) 300-pair 110D (without legs) style blocks or (2) 300-pair 110A (with legs) style blocks

Part Number	Description	Shipping Weight lb (kg)
A1222-LP	2' x 2' Ceiling Enclosure	38 (17.2)
13812-003	2' x 2' Ceiling Enclosure, Large Ports	39 (17.7)
A1024-LP	2' x 4' Ceiling Enclosure	43 (19.6)
A1224-LP	2' x 4' Ceiling Enclosure	45 (20.4)



## Basic Consolidation Enclosures

Basic Consolidation Enclosures (BCE) provide a low-cost, low-density consolidation point for telecommunication cabling. Both Ported (-P) and Non-Ported (-N) enclosures can be configured to be used either above the drop ceiling or below an access floor. All Ported versions (-P) come with a fire-rated foam sealing kit, making them suitable for air handling spaces. Basic Consolidation Enclosures are UL Listed (2043), plenum rated and come with a sealed door and a clear aluminum finish.



## BCE-6-P

BCE-6-P measures 14"W x 6"D x 20"L (360 mm x 150 mm x 510 mm) and includes installation brackets for attachment to building structure with 3/8" threaded rods. (Equipment mounting brackets not included.)

Part Number	Description	Shipping Weight lb (kg)
BCE-6-P	2-Port Enclosure	7 (3.2)



## BCE-24-P/N

BCE-24-P/N measures 14"W x 3"D x 20"L (360 mm x 80 mm x 510 mm). It includes rotating threaded interior mounting brackets for a one rack-mount space (1U) 19" patch panel. Order #12-24 equipment mounting screws

Part Number	Description	Shipping Weight lb (kg)
BCE-24-P	1U 2-Port Enclosure	7 (3.2)
BCE-24-N	1U Non-Ported Enclosure	7 (3.2)



## BCE-48-P/N

BCE-48-P/N measures 14"W x 6"D x 20"L (360 mm x 150 mm x 510 mm). It includes rotating threaded interior mounting brackets for two rack-mount spaces (2U) of 19" patch panels. Order #12-24 equipment mounting screws separately.

Part Number	Description	Shipping Weight lb (kg)
BCE-48-P	2U 2-Port Enclosure	12 (5.4)
BCE-48-N	2U Non-Ported Enclosure	12 (5.4)

## Zone Enclosure Service Parts

CPI provides a variety of replacement parts for zone cabling enclosures. Chrome Lock Kits and Spare Keys enhance security of the Ceiling Enclosure, replacing existing turn locks. Mounting Brackets ensure weight of Raised Floor Enclosure is fully supported.



## Chrome Lock Kits/Spare Keys

Optional locks provide additional security for all standard ceiling enclosures. Includes two locks and two keys.

Part Number	Description
Chrome Lock Kit	Lock Kit, Pair
Spare Keys	Spare Keys, Pair



## Raised Floor Mounting Brackets

Additional brackets used to support Raised Floor Enclosures from access floor support pedestals.

Part Number	Description
RF-BRACKET	Mounting Brackets, 4 each



Wireless and  
Fiber Ready

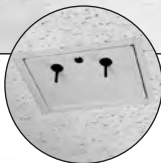

AAT-CAP-00

AAT-CAP-UNI

AAT-CAP-11

AAT-CA P-12

AAT-CAP-1232

AAT-CAP-1242

AAT-CAP



AAT-CAP-1232-KIT

## Ceiling-Mounted Wireless Access Point Enclosures

Ceiling Enclosures create a permanent location for various wireless access points or bridges within drop ceilings. Equipment is supported on the access door. Most access doors are pre-punched with openings for antennas. Ceiling Enclosures include support brackets for use with 2' ceiling "grids." AAT-CAP features interchangeable door-mounted faceplates with mounting brackets for equipment. Universal Faceplate accepts access points up to 2" H x 10" W x 8" D (50 mm x 250 mm x 200 mm) with antenna(s) up to 10.5" (267 mm) apart. Enclosure is finished in white.

Part Number	Description	Shipping Weight lb (kg)
<b>Wireless Ceiling Enclosures Without Faceplates</b>		
AAT-CAP	12 x 10 x 14.5 (305 x 254 x 368)	8 (3.6)
AAT-CAP-10-P	12 x 13 x 14.5 (305 x 330 x 368) with junction box	9 (4.1)
AAT-CAP-S	12 x 5 x 14.5 (305 x 127 x 368)	8 (3.6)
<b>Faceplates For Wireless Enclosures</b>		
AAT-CAP-00	Blank (Solid) Faceplate	3 (1.4)
AAT-CAP-UNI	Universal Faceplate	3 (1.4)
AAT-CAP-11	For Cisco® Aironet® 1100	3 (1.4)
AAT-CAP-12	For Cisco® Aironet® 1200	3 (1.4)
AAT-CAP-1232	For Cisco® Aironet® 1232	3 (1.4)
AAT-CAP-1242	For Cisco® Aironet® 1242	3 (1.4)
<b>AAT-CAP Enclosures, 10" D (250 mm), With Faceplates</b>		
AAT-CAP-00-KIT	Blank (Solid) Faceplate	10 (4.5)
AAT-CAP-UNI-KIT	Universal Faceplate	10 (4.5)
AAT-CAP-11-KIT	Cisco® 1100 Faceplate	10 (4.5)
AAT-CAP-12-KIT	Cisco® 1200 Faceplate	10 (4.5)
AAT-CAP-1232-KIT	Cisco® 1232 Faceplate	10 (4.5)
AAT-CAP-1242-KIT	Cisco® 1242 Faceplate	10 (4.5)
<b>AAT-CAP-S Enclosures, 5" D (130 mm), With Faceplates</b>		
AAT-CAP-S-00-KIT	Blank (Solid) Faceplate	9 (4.1)
AAT-CAP-S-UNI-KIT	Universal Faceplate	9 (4.1)
AAT-CAP-S-12-KIT	Cisco® 1200 Faceplate	9 (4.1)
AAT-CAP-S-1232-KIT	Cisco® 1232 Faceplate	9 (4.1)
AAT-CAP-S-1242-KIT	Cisco® 1242 Faceplate	9 (4.1)

Note: AAT-CAP-11 may only be used with AAT-CAP.





13833-001



WA064-CAP

## Ceiling-Mounted Wireless Enclosure

Ceiling Enclosures create a secure and permanent location for various wireless access points or bridges within drop ceilings. Equipment is supported on the access door. Enclosures are finished in white.

Part Number	Description W x D x L in (mm)	Shipping Weight lb (kg)
13833-001	15.5 x 5 x 16.5 (394 x 127 x 419) Optimized for Cisco® 1250	10 (4.5)
WA064-CAP	10 x 4 x 12.75 (254 x 102 x 324) Optimized for Cisco® Aironet® 350	5 (2.3)

Wireless and  
Fiber Ready



## Dome Wireless Enclosure

The AAT-ACE-DOME replaces a single drop ceiling tile to hide wireless access points in open office spaces. The dome is mounted on a fully hinged locking door, providing easy access to equipment and cables for authorized technicians only.

- (1) 3/4" H x 3" W (19.1 mm x 80 mm) edge-protected cable access port with approved foam sealing kit
- Includes two sets of standoffs to adjust height of back plate within dome
- Enclosure: 23-3/4" W x 3" D x 23-3/4" L (603.3 mm x 80 mm x 603.3 mm)
- Dome: 6-1/2" H (165 mm), 14" Diameter (360 mm)
- Dome is large enough to accommodate most access points, including Cisco's large 1250 series AP
- Product Weight: 10.5 lb (4.76 kg)
- Removable mounting plate is 8 7/8" W x 6-7/8" L (225.43 mm x 174.63 mm)
- Customer must provide (4) 3/8" threaded rods and installation hardware
- Enclosure and dome are finished in white

Part Number	Description W x D x L in (mm)	Shipping Weight lb (kg)
AAT-ACE-DOME	23.75 x 3 x 23.75 (603 x 80 x 603) Domed Wireless Enclosure	21 (9.5)



Wireless and Fiber Ready

## Wireless Wall-Mount Enclosure

Wall-mounted access points provide better wireless coverage in some environments. This enclosure is for interior use and provides a secure and permanent wall-mounted location for various wireless access points and bridges.

- Optimized for Cisco® Aironet® 350
- Enclosure is finished in beige
- UL Listed

Part Number	Description W x D x L in (mm)	Shipping Weight lb (kg)
WA064-WAP	8 x 11 x 3 (200 x 280 x 80)	9 (4.1)



NEMA Rated

## NEMA-Rated Wireless Wall-Mount Enclosure

Wall-mounted wireless access point enclosure designed for warehouse, manufacturing, light industrial and exterior use. Single door is attached with a continuous steel hinge and secured by padlock through a stainless steel padlock hasp. A gasket seals the interior at closure.

- Enclosure is completely sealed; drill cable entry holes to fit application
- Enclosure: fiberglass reinforced polyester, gray
- Enclosure: 11-1/2" H x 9-1/2" W x 4-1/2" D (292 mm x 241 mm x 114 mm)
- Product Weight: 5 lb (2.3 kg); Interior of the enclosure is 3" D (80 mm)
- Maximum equipment size is 9" x 7" x 3" (230 mm x 180 mm x 80 mm)
- Customer must provide installation and cable access hardware
- NEMA 1, 2, 3, 3R, 4, 4X, 12 and 13

Part Number	Description W x D x L in (mm)	Shipping Weight lb (kg)
AAT-MWME-P	11.5 x 9.5 x 4.5 (292 x 241 x 114)	6 (2.7)



NEMA Rated

## Large NEMA-Rated Wireless Wall-Mount Enclosure

Designed for warehouse, manufacturing, light industrial and exterior use. Single front door is attached with a continuous steel hinge and secured by padlock through a stainless steel padlock hasp. A gasket seals the interior at closure.

- Enclosure is completely sealed; drill cable entry holes to fit application
- Removable mounting plate for wireless transmitters
- Enclosure: Fiberglass reinforced polyester, gray
- Product Weight: 7.5 lb (3.4 kg)
- The interior of the enclosure is 5" D (130 mm)
- Maximum equipment size: 13.5" x 11.5" x 5" (343 mm x 292 mm x 130 mm)
- Customer must provide installation and cable access hardware
- NEMA 1, 2, 3, 3R, 4, 4X, 12 and 13

Part Number	Description W x D x L in (mm)	Shipping Weight lb (kg)
AAT-WME-P	15.5 x 13.5 x 6 (394 x 343 x 150)	11 (5.0)



Wireless and  
Fiber Ready

NEMA  
Rated

## Large NEMA-Rated Wireless Wall-Mount Enclosure With Window

The AAT-WMESG-P is for warehouse, manufacturing, light industrial and exterior use. A single front door provides access to equipment. The door is attached with a continuous steel hinge and secured by padlock through a stainless steel padlock hasp. A gasket seals the interior at closure. Large window provides viewing of equipment.

- Enclosure is completely sealed; customer drills cable entry holes to fit application
- Removable mounting plate for wireless transmitters
- Enclosure: Fiberglass reinforced polyester, gray
- Product Weight: 7.5 lb (3.4 kg)
- The interior of the enclosure is 5"D (130 mm)
- Maximum equipment size: 13.5" x 11.5" x 5" (343 mm x 292 mm x 130 mm)
- NEMA 1, 2, 3, 3R, 4, 4X, 12 and 13

Part Number	Description W x D x L in (mm)	Shipping Weight lb (kg)
AAT-WMESG-P	15.5 x 13.5 x 6 (394 x 343 x 150) Large Enclosure with Window	11 (5.0)

## Zone Cabling, Wall-Mount Enclosure

The Wall-Mount Enclosure measures 24"H x 42"W x 7.5"D (610 mm x 1070 mm x 191 mm). Includes mounting positions for passive and active equipment, a junction box and a fan to remove heat generated by active components.

Mounting positions include space for a single 100 pair 110-style termination block, a single 6-port fiber optic adapter panel, two 2U x 19" spaces for patch panels or other panel mount termination hardware and one 3U x 19" space for active components up to 18"D (460 mm).

The enclosure is pre-punched with knockouts for 1/2" or 1-1/2" electrical conduit for cables and has an insulated, locking, fully-hinged double door to reduce noise and provide security.

- Enclosure is finished in beige



Part Number	Description W x D x L in (mm)	Shipping Weight lb (kg)
AAT-AWM-H	24 x 42 x 7.5 (610 x 1070 x 191)	76 (34.4)

# CPI Index



Index - Part Number  
Index - Alphabetical

Page 12-3  
Page 12-11

# CPI New Products

## Cabinets

- F-Series TeraFrame Gen 3 Cabinet System Page 1-4
- N-Series TeraFrame Gen 3 Cabinet System Page 1-19
- GF-Series GlobalFrame Gen 2 Cabinet System Page 1-26
- Z4-Series SeismicFrame Cabinet System Page 1-37

## Cable Management Products

Many Cable Managers are now available in Glacier White as a standard color.

## Cable Runway Products

Many Runway and Tray products now available in Glacier White as a standard color.

- Cable Runway Radius Bend - Additional Widths Page 3-17
- Cable Runway E-Bend - Additional Widths Page 3-17

## Environmental Monitoring & Security Systems

- Remote Infrastructure Management (RIM-750) Page 4-3
- Remote Infrastructure Management (RIM-1000) Page 4-6
- Remote Infrastructure Management Protocol Converter Page 4-10
- Electronic Locking Kits Page 4-11

## Rack Systems

Many Rack products are now available in Glacier White as a standard color.

- KoldLok® 2-Post Grommet Page 8-34

## Seismic Protection Systems

- Z4-Series SeismicFrame Cabinet System Page 9-10
- Z4-Series SeismicFrame Cabinet Accessories Page 9-13

<b>Part #</b>	<b>Page #</b>	<b>Description</b>	<b>Part #</b>	<b>Page #</b>	<b>Description</b>
02004	3-42	Hex Cap Bolts	10683	2-25	Vertical Cable Loop
02006	2-34	Saf-T-Grip Straps	10684	3-34	Tall Pipe Stand
02006	3-42	Hex Lag Screw	10692	3-13	Trough Cable Runway
02009	2-34	Saf-T-Grip Straps	10693	3-13	Trough Cable Runway
02012	2-34	Saf-T-Grip Straps	10695	9-8	Single Earthquake Bracing Kit
03001	3-41	Hex Nuts	10696	9-8	Double Earthquake Bracing Kit
03003	3-36	Slip-On Lock Nut	10697	3-35	Threaded Rod Coupling
04002	3-41	Washer, Type A Plain	10699	3-19	Transition Butt-Splice Kit
04003	3-41	Split Lock Washers	10702	3-29	Spanner Kit
04003	3-41	Split Lock Washers	10709	3-29	Mount Kit, Auxiliary Framing
05006	2-34	Saf-T-Grip Straps	10723	3-17	Runway Radius Bend
05009	2-34	Saf-T-Grip Straps	10724	3-17	Runway Radius Bend
05012	2-34	Saf-T-Grip Straps	10745	3-26	Auxiliary Framing Channel
06001	8-30	Anchors	10746	3-26	Auxiliary Framing Channel
06003	8-30	Anchor Setting Tool	10747	3-26	Auxiliary Framing Channel
06006	2-34	Saf-T-Grip Straps	10748	3-26	Auxiliary Framing Bar Splice
06009	2-34	Saf-T-Grip Straps	10757	3-40	Protective End Caps
06012	2-34	Saf-T-Grip Straps	10758	8-20	Shelf, Small Peripheral
08009	5-10	One Mounting Term Block	10812	2-36	Closed Composite Dist Rings
10001	2-37, 5-11	Stand-Off Tie Bracket	10822	3-17	Runway E-Bend
10175	8-33	Rack Dolly, Wheels	10842	3-39	Insulator Bar Kit
10250	3-11	Universal Cable Runway	10842	5-8	Cable Runway Insulator Kit
10375	8-31	Top Angle	10873	3-37	Slip-On Support Bracket
10419	2-24	Extended Fingers Bracket	10941	2-36	Metal D-Rings
10473	8-31	Heavy Duty Top Angle	10942	2-36	Metal D-Rings
10473	9-7	Heavy-Duty Top Angle	10943	2-36	Metal D-Rings
10487	3-21	Swivel Splice Kits	10991	3-19	Transition Adapter Splice Kit
10488	3-21	Swivel Splice Kits	11019	3-25	Slip-On Framing Clip
10489	3-21	Swivel Splice Kits	11038	8-9	Single Rack Enclosures
10506	3-24	Runway Elevation Kit	11048	8-9	Single Rack Enclosures
10557	3-36	Threaded Rod I-Beam Clamps	11054	8-21	Shelf, 26"D
10559	2-37	Stand-Off Tie Bracket	11085	3-35	Threaded Rod Cover
10559	5-11	Stand-Off Tie-Down L Bracket	11125	2-35	Channel-Mounted Dist Ring
10562	9-6	Universal Bracing Kit	11153	2-24	Extended Fingers Bracket
10565	8-33	Rack Extension Kit	11154	2-24	Extended Fingers Bracket
10587	1-49	Rail Adapter Kit	11157	2-24	Extended Fingers Bracket
10595	3-22	Rack-To-Runway Mounting	11164	8-23	Shelf, Heavy Duty, for 3"
10596	3-38	Cable Retaining Post	11177	8-41	Mounting Brackets, 66 Block
10605	5-8	Rack Insulator Kit	11188	8-41	Mounting Brackets, 66 Block
10605	8-29	Rack Base Kit	11222	10-10	Fan/Filter Kit
10606	3-39	Runway Tray	11228	2-26	Narrow Cable Ring
10607	3-37	Slotted Support Bracket	11230	2-26	Narrow Cable Loop
10608	3-37	Vertical Wall Brackets	11231	8-22	Shelf, Double-Sided, Vented
10609	3-25	Framing Clip	11232	8-22	Shelf, Double-Sided, Vented
10610	5-5	Horizontal Rack Busbar	11235	3-33	Adjustable Floor Stands
10616	3-20	Adjustable Splice Kit	11236	3-33	Adjustable Floor Stands
10620	3-28	J-Bolt Kit	11237	3-33	Adjustable Floor Stands
10621	3-25	Framing Clip	11241	3-33	Adjustable Floor Channel
10622	5-4	Standard Busbars	11252	3-12	TELCO Style Cable Runway
10628	3-26	Auxiliary Framing Channel	11268	3-40	L Bracket
10630	8-30	Raised Floor Rack Support	11275	3-12	UL Classified Cable Runway
10631	8-30	Raised Floor Rack Support	11293	8-20	Shelf, Low Profile
10632	8-30	Raised Floor Rack Support	11294	8-21	Shelf, Low Profile
10635	3-28	J-Bolt Kit	11298	3-18	Heavy-Duty Junction-Splice
10642	3-40	Protective End Caps	11299	3-18	Heavy-Duty Butt-Splice Kit

# INDEX - PART NUMBER

Part #	Page #	Description	Part #	Page #	Description
11301	3-18	Butt-Splice Kit	11754	10-7	Flush Mount Wall Bracket
11302	3-19	Junction-Splice Kit	11755	8-9	Single Rack Enclosure, Fan Kit
11303	3-27	J-Bolt Kit	11755	10-10	Fan/Filter Kit
11304	3-27	J-Bolt Kit	11755	10-17	Silver Frame Fan/Filter Kit
11305	3-27	J-Bolt Kit	11760	8-30	Raised Floor Rack Support
11306	3-28	J-Bolt Kit	11761	8-30	Raised Floor Rack Support
11308	3-32	J-Bolt Kit	11762	8-30	Raised Floor Rack Support
11309	3-32	Foot Kit	11763	8-30	Raised Floor Rack Support
11310	3-34	Threaded Ceiling Kit	11764	2-30	Slip-On Cover
11312	3-30	Triangular Support Bracket	11781	2-21	Double-Sided, VCS Ext.
11313	3-20	45° Runway Splice Kit	11781	2-22	Double-Sided, VCS Ext.
11314	3-20	90° Runway Splice Kit	11782	2-21	Double-Sided, VCS Ext.
11347	10-4	Universal Swing Gate Rack	11782	2-22	Double-Sided, VCS Ext.
11348	10-4	Universal Swing Gate Rack	11790	10-5	Standard Swing Gate Rack
11359	8-22	Shelf, Low Profile, Vented	11791	10-5	Standard Swing Gate Rack
11374	2-20	Single-Sided, Wide, VCS	11792	10-5	Standard Swing Gate Rack
11378	2-19	Single-Sided, VCS Ext.	11793	10-5	Standard Swing Gate Rack
11378	2-20	Single-Sided, VCS	11794	10-5	Standard Swing Gate Rack
11406	3-36	Ceiling Support Brackets	11795	10-5	Standard Swing Gate Rack
11408	3-36	Runway Support Brackets	11807	10-5	Standard Swing Gate Rack
11415	8-23	Shelf, Sliding Equipment	11808	10-5	Standard Swing Gate Rack
11420	3-32	Wall Angle	11809	1-55	Narrow Cable Manager
11421	3-31	Wall Angle Support Kit	11810	8-40	XLBET 110A Mounting System
11430	3-29	J-Bolt Kit	11817	1-55	Narrow Cable Manager, Kit
11431	3-29	J-Bolt Kit	11837	10-14	Horizontal Wire Mgmt Bar
11440	3-35	Threaded Drop Rods	11840	10-12	Cube-iT Wall Cabinet
11450	3-26	Auxiliary Framing Channel	11890	10-12	Cube-iT Wall Cabinet
11487	8-26	Monitor Shelf, Single Tray	11900	10-12	Cube-iT Wall Cabinet
11488	8-26	Monitor Shelf	11901	10-12	Cube-iT Wall Cabinet
11520	8-40	XLBET 110A Mounting System	11911	3-24	Runway to Rail Rack Kit
11521	8-41	Mounting Bracket Panel	11913	1-63	32"D Sliding Shelf
11522	8-41	Mounting Bracket, Panel	11914	1-63	32"D Sliding Shelf
11523	8-41	Mounting Bracket, Panel	11922	2-23	Cabling Section Cover
11524	8-41	Mounting Bracket Panel	11923	2-23	Cabling Section Cover
11525	8-41	Mounting Bracket Panel	11927	1-60, 8-35	Rack Mount Unit Labels
11546	8-28	Keyboard Tray, 19" Full Size	11959	3-19	Corner Bracket
11554	8-33	Rack Dolly, Rollers	11960	10-8	Fixed Wall-Mount Rack
11558	8-9	Rack Enclosure, Metal Door	11961	10-8	Fixed Wall-Mount Rack
11563	2-32	Large Horizontal Cable Ring	11962	10-8	Fixed Wall-Mount Rack
11564	2-33	Large Horizontal Ring Panel	11963	10-8	Fixed Wall-Mount Rack
11570	2-37	Cable Strain Relief Bracket	11964	10-8	Fixed Wall-Mount Rack
11583	10-9	Flush Mounting Wall Bracket	11965	10-8	Fixed Wall-Mount Rack
11584	2-19	Single-Sided, VCS Ext.	11972	1-51	Seismic Frame Cabinet
11584	2-20	Single-Sided, VCS Ext.	11973	1-51	Seismic Frame Cabinet
11592	9-7	Rack Seismic Gusset Kit	11974	1-51	Seismic Frame Cabinet
11643	8-33	Rack Dolly, Mid-Size	11996	10-12	Cube-iT Wall Cabinet
11680	10-17	Silver Frame Cabinet	12035	2-35	Open Composite Dist Ring
11685	10-17	Silver Frame Cabinet	12062	8-26	Keyboard Tray, Sliding, Single
11690	8-27	Keyboard Tray, 23" w/Mouse	12096	2-21	Double-Sided, Narrow VCS
11700	3-39	End Closing Kit	12100	3-16	Runway Radius Drop
11729	2-22	Double-Sided, Wide VCS	12101	3-16	Runway Radius Drop
11730	2-19	Single-Sided, Narrow, VCS	12115	3-16	Runway Cross Member
11746	3-30	Triangular Support Bracket	12121	3-23	Rack-To-Runway Mounting
11752	2-33	Rack Cabling Managers	12127	2-36	Composite Distribution Rings
11753	2-33	Rack Cabling Managers	12170	3-13	Quick Ship Cable Runway

Part #	Page #	Description	Part #	Page #	Description
12176	2-30	Patch Panel Management Bar	12665	8-28	Shelf, Space Saving
12183	2-31	Jumper Tray	12680	10-17	Silver Frame Wall Cabinet
12185	2-31	Jumper Tray	12685	10-17	Silver Frame Wall Cabinet
12186	2-31	Transition Tray	12700	1-63, 8-16	Shelf, Heavy-Duty
12187	2-31	Jumper Tray	12717	8-27	Keyboard Tray, Flush Mount
12188	2-23	Cabling Section Cover	12730	3-22	Rack-To-Runway Mounting
12189	2-23	Cabling Section Cover	12731	3-23	Rack-To-Runway Mounting
12193	8-28	Keyboard Tray, 19" Sliding	12751	8-24	anyServer Bracket
12227	8-23	Shelf, Extra Extended	12752	8-24	anyServer Bracket
12228	2-25	Double-Wide Cable Ring	12759	8-24	anyServer Bracket
12264	10-9	Wall-Mount Enclosure	12766	2-27	Fiber Management Spools
12265	10-9	Wall-Mount Enclosure	12787	10-12	Cube-iT Mounting Rails
12291	10-10	Shelf, 10"D	12795	10-5	Heavy Duty Swing Gate Kit
12293	8-23	Shelf, Heavy Duty, for 6"	12796	10-15	Cube-iT Mounting Bracket
12309	8-36	Rack Channel Standoffs	12803	10-14	Cube-iT Light
12310	8-36	Rack Channel Standoffs	12804	10-14	Cube-iT Fan Kit
12311	8-36	Rack Channel Standoffs	12805	10-14	Cube-iT Fan Kit
12312	8-35	Equipment Support Bracket	12806	10-14	Cube-iT Fan Kit
12324	10-9	Wall-Mount Enclosure	12816	7-2, 10-10	Power Strips, Horizontal
12325	10-9	Wall-Mount Enclosure	12820	7-24, 10-15	Power Strips, Horizontal
12334	1-61	Fixed Shelf	12830	2-17	Global Vertical Cabling Section
12335	1-61	Fixed Shelf	12831	2-17	Global Vertical Cabling Section
12336	1-61	Fixed Shelf	12832	2-17	Global Vertical Cabling Section
12337	1-61	Fixed Shelf	12833	2-17	Global Vertical Cabling Section
12338	1-62	Sliding Shelf	12834	2-17	Global Vertical Cabling Section
12339	1-62	Sliding Shelf	12835	2-17	Global Vertical Cabling Section
12345	1-62	Sliding Shelf	12836	2-17	Cable Rings, GVCS
12346	1-62	Sliding Shelf	12848	7-23	Power Strips, Vertical
12362	3-38	Center Support Kit	12850	7-23	Power Strips, Vertical
12370	2-23	Finger Snap Cable Guides	12858	10-6	Corner Cushions
12392	2-32	Rack Radius Drop	12891	2-24	Extended Fingers Bracket
12393	2-32	Rack Radius Drop	12934	10-16	Surge-Suppressed Receptacle
12394	2-32	Rack Radius Drop	12955	10-16	Fiber Slack Manager Panel
12407	9-7	Adjustable Bracing Kit	13044	8-37	Panel Adapter
12408	3-22	Rack-To-Runway Mounting	13050	10-16	ThinLine Wall Cabinet
12409	3-23	Rack-To-Runway Mounting	13051	10-16	ThinLine Fan Kit
12419	10-12	Cube-iT Wall Cabinet	13070	2-30	Horizontal Wire Panel
12465	1-50	Vertical Cable Manager	13075	2-30	Horizontal Wire Panel
12477	9-9	Adjustable Bracing Kit	13079	2-25	Vertical Wire Loop
12480	1-48	Fan Kit	13082	1-59, 8-25	Lockable Storage Drawer
12487	8-26	Monitor Shelf, Single Tray	13083	1-59, 8-25	Lockable Storage Drawer
12505	1-49	Ventilation Foam Insert	13084	1-59, 8-25	Lockable Storage Drawer
12507	1-49	Filtered Ventilation Filter	13168	1-50	Enhanced Cable Manager
12510	1-49	Filtered Ventilation System	13169	1-50	Enhanced Cable Manager
12511	1-49	Filtered Ventilation System	13170	1-50	Enhanced Cable Manager
12541	2-30	Horizontal Wire Panel	13171	1-50	Enhanced Cable Manager
12542	2-30	Horizontal Wire Panel	13185	1-59, 8-25	Lockable Storage Divider
12573	1-62	Low Profile Fixed Shelf	13239	7-24	Power Strips, Horizontal
12610	1-62	Low Profile Fixed Shelf	13265	10-12	Cube-iT Wall Cabinet
12637	1-60, 8-17	Hardware Kits	13275	10-12	Cube-iT Wall Cabinet
12638	1-60, 8-17	Hardware Kits	13276	10-13	Cube-iT Mounting Rails
12639	1-60, 8-17	Hardware Kits	13285	10-15	Cube-iT Mounting Bracket, 90°
12663	2-30	Cable Cover	13286	10-15	Cube-iT Mounting Bracket
12664	2-23	Cabling Section Cover	13287	10-14	Cube-iT Term Block Panel
12664	2-23	Cabling Section Cover	13288	10-14	Cube-iT Term Block Panel



# INDEX - PART NUMBER

Part #	Page #	Description	Part #	Page #	Description
13336	1-48, 1-55	Air Dam Kit, Airflow Baffles	13875	1-58	KoldLok Round Grommet
13392	3-14	Cable Pathway Divides	13876	1-57	AisleLok Acrycell Sealing Tape
13393	1-59	Universal Cabinet Light	13877	1-57	AisleLok Under Rack Panel
13394	3-15	PatchRack for Cable Runway	13878	8-34	Grommet, 2-Post, KoldLok
13395	3-15	PatchRack for Cable Runway	13883	9-4	Seismic Frame 2-Post Rack
13396	3-15	PatchRack Accessory	13884	9-4	Seismic Frame 2-Post Rack
13399	3-15	PatchRack Accessory	13885	9-4	Seismic Frame 2-Post Rack
13480	8-28	Keyboard Tray, 4-Post	13885	9-4	Seismic Frame 2-Post Rack
13483	10-12	Cube-IT Floor Mount Kit	13901	2-9	Single-Sided Cable Manager
13485	10-14	Cube-IT Cable Manager	13902	2-9	Single-Sided Cable Manager
13490	8-28	Keyboard Tray, 2-Post	13904	2-9	Single-Sided Cable Manager
13491	10-13	Cube-IT Floor Cabinet	13905	2-9	Single-Sided Cable Manager
13492	10-13	Cube-IT Floor Cabinet	13911	2-10	Double-Sided Cable Manager
13493	10-13	Cube-IT Floor Cabinet	13912	2-10	Double-Sided Cable Manager
13494	10-13	Cube-IT Floor Cabinet	13914	2-10	Double-Sided Cable Manager
13495	10-13	Cube-IT Floor Cabinet	13915	2-10	Double-Sided Cable Manager
13496	10-13	Cube-IT Floor Cabinet	13928	2-11	Cable Lashing Bar Kit
13501	8-30	Raised Floor Rack Support	13930	2-28	Horizontal Cable Manager
13515	8-30	Raised Floor Rack Support	13934	2-11	Cable Ring Manager, Velocity
13517	1-61	Rack-Mount Cable Shelf	13935	2-11	Cable Spool Kit, Velocity
13571	1-58	KoldLok Integral Grommet	14061	9-9	Seismic Equipment Bracing
13576	1-58	KoldLok Surface Grommet	14068	1-50	Vertical Cable Manager Ring Kit
13602	10-6	EasySwing Wall-Mount Rack	14070	1-61	Fixed Shelf
13604	10-6	EasySwing Wall-Mount Rack	14072	1-61	Fixed Shelf
13608	10-6	EasySwing Wall-Mount Rack	14171	1-57	HotLok Snap-In Filler Panels
13622	5-3	Grounding Busbars	14172	1-57	HotLok Snap-In Filler Panels
13653	7-21	PDU, Horizontal	14435	1-40, 9-13	Air Dam Kit
13671	1-58	KoldLok Split Grommet	14440	1-41, 9-14	Ring Cable Manager
13674	1-58	KoldLok Brush Grommet	14445	1-41, 9-14	Ring Cable Manager
13675	1-58	KoldLok Brush Grommet	14465	1-42, 9-15	Cable Lashing Bracket
13676	1-58	KoldLok Surface Grommet	14480	1-42	Full Height Dual PDU Bracket
13677	1-58	KoldLok Surface Grommet	14481	1-42	Full Height Dual PDU Bracket
13696	9-4	Cable Management Fingers	14485	1-41, 9-14	Front-To-Rear Cable Manager
13697	9-5	Power Strip Mounting Kit	14830	2-17	Global Vertical Cabling Section
13698	9-5	Duplex Electrical Outlet Box	14831	2-17	Global Vertical Cabling Section
13699	9-5	VCS Offset Mounting Bracket	14832	2-17	Global Vertical Cabling Section
13702	9-5	Floor Anchor Kit, Concrete	15002	2-26	Cable Distribution Spools
13703	9-5	Floor Drilling Template	15008	2-7	Cable Distribution Spools
13704	9-5	VCS Vertical Cabling Section	15053	8-17	QuadraRack Server Frame
13730	3-22	Rack-To-Runway Mounting	15205	8-16	Runway Mounting Bracket
13731	3-23	Rack-To-Runway Mounting	15211	8-14	Adjustable ServerRack
13762	7-31	PDU Mounting Brackets, PDU	15212	8-14	Adjustable ServerRack
13772	11-4	Raised Floor Enclosure	15213	8-14	Adjustable ServerRack
13780	7-31	PDU Mounting Brackets, PDU	15214	8-14	Adjustable ServerRack
13812	11-6	Ceiling Enclosures	15215	8-14	Adjustable QuadraRack
13813	11-7	Ceiling Enclosures	15216	8-14	Adjustable QuadraRack
13833	11-11	Wireless, Ceiling Enclosure	15217	8-14	Adjustable QuadraRack
13853	9-4	Seismic Frame 2-Post Rack	15218	8-14	Adjustable QuadraRack
13854	9-4	Seismic Frame 2-Post Rack	15235	8-16	Equipment Rail, 4-Post
13855	9-4	Seismic Frame 2-Post Rack	15245	8-15	Shelves, Solid, 4-Post
13856	9-4	Seismic Frame 2-Post Rack	15251	8-11	Adjustable Rail QuadraRack
13870	1-58	KoldLok Wave Grommet	15252	8-11	Adjustable Rail QuadraRack
13872	1-58	KoldLok Mini Grommet	15253	8-11	Adjustable Rail ServerRack
13873	1-58	KoldLok Wave Grommet Cover	15254	8-11	Adjustable Rail ServerRack
13874	1-58	KoldLok Round Grommet	15255	8-15	Shelves, Vented, 4-Post

Part #	Page #	Description	Part #	Page #	Description
15259	8-12	Fixed Rail, ARQR	20283	3-41	Washer, Type A Plain
15260	8-12	Fixed, ARSR	20290	3-42	Hex Cap Bolts
15270	8-12	Side Panel, ARQR	20502	2-37	Jack Plate Mounting Bracket
15275	8-12	Cable Waterfall Tray	23480	8-28	Keyboard
15285	8-12	Equipment Rail, ARQR	25140	7-31	PDU Mounting Brackets, PDU
15286	8-12	Cable Guide, ARQR	25190	1-31	Cable Port Brush Kit
15320	10-7	Heavy Duty Wall Rack	25400	3-40, 8-32	Touch-Up Paint
15321	10-7	Heavy Duty Wall Rack	25401	3-40, 8-32	Touch-Up Paint
15322	10-7	Heavy Duty Wall Rack	30013	8-41	Mounting Bar Rack-Mounted
15323	10-7	Heavy Duty Wall Rack	30014	8-41	Mounting Bar, Rack-Mounted
15330	8-16	Center Rail, 4-Post	30015	8-41	Mounting Bar, Rack-Mounted
15335	8-16	Center Rail, 4-Post	30016	8-41	Mounting Bar, Rack-Mounted
15555	8-27	Keyboard Tray, Sliding	30024	8-32	Filler Panel
15556	8-27	Keyboard Tray, Sliding	30025	8-32	Filler Panel
15640	7-29	International Power Strips	30026	8-32	Filler Panel
15642	7-26	International Power Strips	30027	8-32	Filler Panel
15643	7-27	International Power Strips	30091	2-13	MCS Master Cabling Section
15644	7-26	International Power Strips	30092	2-13	MCS Master Cabling Section
15645	7-27	International Power Strips	30093	2-13	MCS Master Cabling Section
16270	1-18	Air Dam Kit	30094	2-13	MCS Master Cabling Section
16271	1-18	Baying/Fascia Kit	30095	2-13	MCS Master Cabling Section
16272	1-18	Cable Lashing Bar	30096	2-13	MCS Master Cabling Section
16273	1-18	Cable Lashing Bracket	30130	2-29	UHCM Cable Manager, SS
16274	1-18	Power Strip Bracket	30131	2-29	UHCM Cable Manager, SS
16275	1-18	Cable Ring Manager	30139	2-29	UHCM Cable Manager, SS
16277	1-18	Side Skirt	30161	2-15	CCS Combo Cabling Section
16278	1-18	Bottom Panel	30162	2-15	CCS Combo Cabling Section
16279	1-18	Bolt Down Kit	30163	2-15	CCS Combo Cabling Section
16280	1-18	Unload Ramp	30164	2-15	CCS Combo Cabling Section
16298	3-18	Heavy-Duty Junction-Splice	30165	2-15	CCS Combo Cabling Section
16299	3-18	Heavy-Duty Butt-Splice Kit	30166	2-15	CCS Combo Cabling Section
16301	3-18	Butt-Splice Kit	30330	2-29	UHCM Cable Manager, SS
16302	3-19	Junction-Splice Kit	30331	2-29	UHCM Cable Manager, SS
16313	3-20	45° Runway Splice Kit	30339	2-29	UHCM Cable Manager, SS
16314	3-20	90° Runway Splice Kit	30529	2-29	UHCM Cable Manager, DS
16341	8-19	Rack Line-Up Spacer, 4-Post	30530	2-29	UHCM Cable Manager, DS
16342	8-19	Rack Line-Up Spacer, 4-Post	30531	2-29	UHCM Cable Manager, DS
16350	8-19	Shelf, Heavy-Duty, 4-Post	31410	8-35	Rack Panel Adapters
16351	8-19	Shelf, Heavy-Duty, 4-Post	31420	8-35	Rack Panel Adapters
16356	8-19	Rack Line-Up Spacer, 4-Post	31430	8-35	Rack Panel Adapters
16487	3-21	Swivel Splice Kits	31440	8-35	Rack Panel Adapters
16488	3-21	Swivel Splice Kits	31450	8-35	Rack Panel Adapters
16489	3-21	Swivel Splice Kits	31470	3-31	Runway Standoff Support Kit
17000	2-38	Mag-Clips, Medium	31472	3-14	Alternate Space Runway
17250	2-38	Mag Clips, Wrap-Around	31473	3-24	Runway to Rail Rack Kit
17260	2-38	Mag Clips, Wrap-Around	32710	1-82	Ceiling Panel Kit, CAC
17350	2-38	Mag Clips, Wrap-Around	32711	1-82	Ceiling Panel Kit, CAC
17500	2-38	Mag Clips, Large	32720	1-79	Universal Cabinet Panel, HAC
17761	7-31	PDU Sensors	32720	1-82	Universal Cabinet Panel, CAC
17763	7-30	Power Cords, IEC C20 PDU	32728	1-79	Adjustable Filler Panel, HAC
20015	3-41	Split Lock Washers	32728	1-82	Adjustable Filler Panel, CAC
20017	3-41	Hex Nuts	32770	1-65	Door Assembly
20067	8-30	Anchors	32780	1-65	Door Assembly
20141	3-41	Split Lock Washers	32805	1-67	Door Mounting Bracket
20142	3-41	Hex Nuts	32817	1-66	Door Top Seal Kit

# INDEX - PART NUMBER

Part #	Page #	Description	Part #	Page #	Description
32820	1-74	Exhaust Duct Panel Kit, HAC	35497	2-6	Solid Mid Panel, Evolution
32825	1-75	Adjustable Filler Panel, HAC	35501	2-6	Solid Rear Panel, Evolution
32830	1-74	Exhaust Duct Panel Kit, HAC	35502	2-6	Solid Side Panel, Evolution
32835	1-75	Duct Seal, HAC	35503	2-5	Cable Divider Bar, Evolution
32836	1-75	Duct Edge Seal, HAC	35505	2-7	Cable Distribution Spool Kit
32836	1-78	Exhaust Edge Seal, FSHAC	35506	2-5	Floor Bracket, Evolution
32850	1-74	Exhaust Duct Panel Kit, HAC	35511	2-4	Single-Sided Cable Manager
32870	1-66	Door Standoff Kit	35512	2-4	Single-Sided Cable Manager
32875	1-65	Floor Mounting Template	35513	2-4	Single-Sided Cable Manager
32990	1-78	Exhaust Duct, FSHAC	35514	2-4	Single-Sided Cable Manager
32995	1-78	Blanking Panel, FSHAC	35515	2-4	Single-Sided Cable Manager
33000	1-70	Build To Spec Kit	35521	2-4	Double-Sided Cable Manager
33002	1-71	Blanking Panel, BTS	35522	2-4	Double-Sided Cable Manager
33003	1-71	Universal Bulb Seal, BTS	35523	2-4	Double-Sided Cable Manager
34134	3-7	C Support Bracket	35524	2-4	Double-Sided Cable Manager
34135	3-10	Conduit Bracket	35525	2-4	Double-Sided Cable Manager
34136	3-10	Auxiliary Side Bracket	35571	2-4	Combination Cable Manager
34137	3-10	Side Support Bracket	35572	2-4	Combination Cable Manager
34138	3-10	Electric Box Bracket	35573	2-4	Combination Cable Manager
34139	3-10	Vertical Radius Bend	35574	2-4	Combination Cable Manager
34140	3-7	Under Floor C Support Bracket	35575	2-4	Combination Cable Manager
34142	3-8	Cable Tray Liner	35593	7-32	PowerScope In-Line Meter
34144	3-8	Cable Tray Liner	35616	7-21	PDU, Vertical
34537	1-9, 1-30, 9-13	Snap-In Filler Panel	35622	7-21	PDU, Vertical
34538	1-9, 1-30, 9-13	Snap-In Filler Panel	35623	7-22	PDU, Vertical
34728	3-4	Carriage Bolt Washer	35632	7-20	PDU, Vertical
34729	3-6	Center Support Bracket	35633	7-23	PDU, Vertical
34730	3-5	Trapeze Support Bracket	35643	7-20	PDU, Vertical
34732	3-7	Rack-Mount Hook	35662	7-21	PDU, Horizontal
34733	3-6	Triangle Support Bracket	35663	7-21	PDU, Horizontal
34734	3-5	L Support Bracket	35676	7-21	PDU, Horizontal
34735	3-6	Wall Mount Angle	35682	7-21	PDU, Horizontal
34736	3-7	Under Floor Support Bracket	35683	7-22	PDU, Horizontal
34737	3-7	Pedestal Clamp Bracket	35692	7-21	PDU, Horizontal
34738	3-4	Standard Splice Kit	35693	7-21	PDU, Horizontal
34739	3-4	Splice Bar	35700	7-31	PDU Mounting Brackets
34740	3-4	90° Splice Bar Kit	35815	7-24	PDU, Vertical
34741	3-9	Tool-Less Radius Drop	35821	7-21	PDU, Vertical
34743	3-8	Cable Tray Divider	35822	7-21	PDU, Vertical
34744	3-8	Cable Tray Cover	35823	7-21	PDU, Vertical
34745	3-8	Cable Tray Bottom Insert	35882	7-22	PDU, Horizontal
34746	3-4	Clamp Washer	35882	7-22	PDU, Horizontal, PowerWedge
34747	3-9	Large Radius Drop	35883	7-22	PDU, Horizontal, PowerWedge
34749	3-9	Label Holder	35992	7-32	PowerScope In-Line Meter
34811	3-3	OnTrac Wire Mesh Cable Tray	36811	3-3	OnTrac Wire Mesh Cable Tray
34821	3-3	OnTrac Wire Mesh Cable Tray	36821	3-3	OnTrac Wire Mesh Cable Tray
34831	3-3	OnTrac Wire Mesh Cable Tray	36831	3-3	OnTrac Wire Mesh Cable Tray
34834	3-4	Spring Splice Kit	37200	6-3	17 Inch LCD KVM Drawer
34838	3-9	Split Bolt Grounding Clamp	37201	6-3	17 Inch LCD KVM Drawer
34839	3-8	Cable Tray Cutting Tool	37202	6-5	Analog KVM Switch DB15
35441	2-28	Horizontal Cable Manager	37203	6-5	Analog KVM Switch DB15
35473	2-5	Cable Lashing Kit	37204	6-5	Analog KVM Switch DB15
35475	2-5	Fiber Segregation Kit	37205	6-10	IP KVM Switch Cat 5/6 Ports
35492	2-7	Fixed Accessory Panel	37206	6-10	IP KVM Switch Cat 5/6 Ports
35493	2-7	Movable Mid Section	37207	6-10	IP KVM Switch Cat 5/6 Ports

Part #	Page #	Description	Part #	Page #	Description
37208	6-12	KVM Cables	40093	2-14	MCS-EFX Master Cabling Section
37209	6-7	IP KVM Switch w/BD15 Ports	40094	2-14	MCS-EFX Master Cabling Section
37210	6-10	Analog KVM Switch Cat 5/6	40095	2-14	MCS-EFX Master Cabling Section
37212	6-7	IP KVM Switch w/BD15 Ports	40096	2-14	MCS-EFX Master Cabling Section
39033	1-32	Side Panel	40097	2-14	MCS-EFX Master Cabling Section
39037	1-32	Side Panel	40098	2-16	CCS-EFX Combination Cabling Section
39043	1-10	Side Panel	40099	2-16	CCS-EFX Combination Cabling Section
39047	1-10	Side Panel	40100	2-16	CCS-EFX Combination Cabling Section
39076	1-35	Seal Kit	40108	8-22	Shelf, Double-Sided
39077	1-10, 1-33	Front-To-Rear Cable Manager	40117	8-20	Shelf, Single Sided, Vented
39080	1-31	Bottom Panel	40118	8-20	Shelf, Single Sided, Vented
39085	1-9, 1-30	Air Dam Kit	40153	5-3	Grounding Busbars
39086	1-12, 1-34	Full Height PDU Bracket	40156	5-5	Busbar Assemblies
39087	1-13	Cable Ring Manager	40157	5-8	Rack Busbar Insulator Block
39088	1-13	Cable Ring Manager	40158	5-5	Busbar Assemblies
39089	1-35	Ring Cable Manager	40159	5-10	Equipment Ground Jumper Kit
39107	1-31	Air Director	40159	5-10	Ground Wire
39110	7-31	PDU Mounting Brackets	40160	5-6	Vertical Rack Busbar
39112	1-11, 1-33	Finger Cable Manager	40161	5-7	Vertical Rack Busbar Kits
39120	1-11, 1-33	Finger Cable Manager	40162	5-14	Compression Lugs
39124	1-12, 1-34	Cable Lashing Bracket	40163	5-15	C-Type Compression Taps
39127	1-13	Cable Ring Manager	40164	5-9	Cable Runway Ground Strap Kit
39128	1-13	Cable Ring Manager	40165	5-14	Mechanical Compressions Tools
39129	1-13	Cable Ring Manager	40166	5-13	Antioxidant Joint Compound
39130	1-9	Air Dam Kit	40167	5-9	Two Hole Ground Terminal Block
39131	1-12, 1-34	Cable Lashing Bracket	40168	5-13	Copper-To-Copper Joint Compound
39132	1-8	Bottom Panel	40169	5-12	Pedestal Clamp with Ground
39133	1-30, 9-13	Equipment Rail Grommet Kit	40170	5-12	Pipe Clamp with Ground Connector
39137	1-32	Bay Seal Kit	40172	5-6	Vertical Rack Ground Bar Kit
39150	1-34	Leveling Feet Height Tool	40602	8-29	Rack Line-Up Spacer Kit
39151	1-36	Label Holder Kit	40604	8-29	Installation Kits, Concrete Floor
39177	1-8	Vertical Exhaust Duct	40605	1-60, 5-3	Hardware Kits, Tapped Rail
39207	1-36	Ramp Kit	40606	8-38	Mounting Screws, Pan Head
39208	1-67	Containment Floor Seal Kit	40607	8-29	Installation Kits, Wood Floor
39209	1-67	Containment Floor Seal Kit	40702	8-29	Rack Line-Up Spacer Kit
39221	1-12, 1-34	Full Height PDU Bracket	40750	8-21	Shelf, Single-Sided, Steel
39222	1-14, 4-11	Electronic Lock Kit	40751	8-21	Shelf, Double-Sided, Steel
39223	1-14, 4-11	Electronic Lock Kit	41021	8-31	Base Angle
39224	1-36, 4-11	Electronic Lock Kit	41050	8-34	Rack Base Cover
39225	1-36, 4-11	Electronic Lock Kit	42050	8-34	Rack Base Cover
39226	1-14, 4-11	Electronic Lock Kit	46053	8-4	Universal Rack
39227	1-14, 4-11	Electronic Lock Kit	46083	8-4	Universal Rack
39228	1-36	Electronic Lock Kit	46353	8-4	Universal Rack
39325	1-11, 1-33	Finger Cable Manager	46363	8-5	Universal Rack, 35"
39327	1-25	Radius Drop	46383	8-4	Universal Rack
39377	1-24	Telescoping Cable Manager	46763	8-4	Universal Rack
39380	1-25	Cable Lashing Manager	46783	8-4	Universal Rack
39381	1-25	Cable Lashing Manager	48353	8-4	Universal Rack
40056	8-34	Equipment Guard Rail	48383	8-4	Universal Rack
40057	8-34	Equipment Guard Rail	50110	8-18	ExpandaRack
40058	8-34	Equipment Guard Rail	50120	8-18	QuadraRack 4-Post Frame
40059	8-34	Equipment Guard Rail	50130	8-18	ExpandaRack
40074	8-20, 10-10	Shelf, Single Sided	50150	8-18	ExpandaRack
40075	8-20	Shelf, Single Sided	50160	8-18	ExpandaRack
40092	2-14	MCS-EFX Master Cabling Section	55053	8-7	Standard Rack, 3'D

# INDEX - PART NUMBER

Part #	Page #	Description	Part #	Page #	Description
55100	8-39	High Density Patching Frame	AAT-CAP-UNI	11-10	Wireless, Faceplate, Universal
55104	8-39	High Density Frame, Mounting Kit	AAT-MWME-P	11-12	Wireless Enclosure, NEMA
55105	8-39	High Density Frame, Mounting Kit	AAT-WME-P	11-12	Wireless Enclosure, NEMA
57001	2-18	Global Standard Pack	AAT-WME5G-P	11-13	Wireless, NEMA w/Window
57002	2-18	Global Standard Pack	BCE-24-N	11-8	Basic Consolidation Enclosures
57003	2-18	Global Standard Pack	BCE-24-P	11-8	Basic Consolidation Enclosures
57004	2-18	Global Standard Pack	BCE-48-N	11-8	Basic Consolidation Enclosures
57011	2-12	Velocity Standard Pack	BCE-48-P	11-8	Basic Consolidation Enclosures
57012	2-12	Velocity Standard Pack	BCE-6-P	11-8	Basic Consolidation Enclosures
57013	2-12	Velocity Standard Pack	Chrome Lock Kit	11-9	Chrome Lock Kit
57014	2-12	Velocity Standard Pack	CPI0600XXXX	7-33	IT-Series 600-2000V UPS
60100	4-3	RIM-750	CP1105LPXXX	7-35	LP-11U Series UPS
60101	4-8	RIM-1000	CP1161XX	7-34	GT-Series 1000-3000VA UPS
60103	4-8	Expansion Card, RIM-1000	CP12391XXX	7-34	GT-Series 5000-6000VA UPS
60106	4-10	RIM Protocol Converter	CP12391XXX	7-35	GT-Series 8000-10000VA UPS
60107	4-4	Rack Mount Bracket, RIM	CP1255XX	7-33	VH Series UPS
60108	4-5	Temp Sensor, RIM-750	CXXX-XXX	1-54	C-Series SlimFrame Cabinet
60109	4-5	Leak Spot Detector, RIM-750	EXXX-XXX	1-56	E-Series ISP Co Location Cabinet
60109	4-5	Leak Sensor Rope, RIM	FHD-XXX-XXXX	1-17	F-Series TeraFrame HD Cabinet
60110	4-5	Power Fail Monitor, RIM-750	FX-XXXX	1-1	F-Series TeraFrame Cabinet
60111	4-9	Temp Sensor, RIM-1000	GF-XXXX-XX	1-27	GF-Series GlobalFrame Gen2 Cabinet
60112	4-9	Temp Sensor Mini, RIM-1000	MXXX-XXX	1-46	M-Series MegaFrame Cabinet
60113	4-5	Smoke Detector, RIM-750	NXX-XXXX-XXX	1-21	N-Series TeraFrame Gen 3 Cabinet
60114	4-5	Motion Detector, RIM-750	P1-XXXX	7-7	eConnect Basic PDU
60115	4-5	Magnetic Door Sensor, RIM	P3-XXXX	7-10	eConnect Monitored PDU
60116	4-5	Leak Detection Cable	P4-XXXX	7-13	eConnect Monitored Pro PDU
66353	8-8	Standard Rack, 6"D	P5-XXXX	7-16	eConnect Switched PDU
A0222-RF	11-4	Raised Floor Enclosure	P6-XXXX	7-18	eConnect Switched Pro PDU
A0422-RF	11-4	Raised Floor Enclosure	RF-BRACKET	11-9	Mounting Brackets
A0622-RF	11-4	Raised Floor Enclosure	Spare Keys	11-9	Spare Keys
A0802-RF-DI	11-5	Raised Floor Enclosure w/Cover	WA064-CAP	11-11	Wireless Enclosure
A0822-RF	11-4	Raised Floor Enclosure	WA064-WAP	11-12	Wireless, Wall Mount Enclosure
A0822-RF-F	11-5	Raised Floor Enclosure, Fiber	Z4-XXX-XXXX	1-38, 9-11	Z4-Series SeismicFrame Cabinet
A1024-HR	11-6	Ceiling Enclosures, Switches			
A1024-LP	11-7	Ceiling Enclosures, Wiring Blocks			
A1024-PP	11-7	Ceiling Enclosures, Patch Panels			
A1222-HR	11-6	Ceiling Enclosures, Switches			
A1222-LP	11-7	Ceiling Enclosures, Wiring Blocks			
A1222-PP	11-7	Ceiling Enclosures, Patch Panels			
A1224-HR	11-6	Ceiling Enclosures, Switches			
A1224-LP	11-7	Ceiling Enclosures, Wiring Blocks			
A1224-PP	11-7	Ceiling Enclosures, Patch Panels			
A1411-RF-HR	11-5	Raised Floor Enclosure			
A1422-RF	11-4	Raised Floor Enclosure			
A1422-RF-F	11-5	Raised Floor Enclosure, Fiber			
AAT-ACE-DOME	11-11	Wireless, Dome Enclosure			
AAT-AWM-H	11-13	Zone, Wall-Mount Enclosure			
AAT-CAP	11-10	Wireless, Ceiling Mounted			
AAT-CAP-00	11-10	Wireless, Faceplate, Blank			
AAT-CAP-10-P	11-10	Wireless, Ceiling Mounted			
AAT-CAP-11	11-10	Wireless, Faceplate, Cisco 1100			
AAT-CAP-12	11-10	Wireless, Faceplate, Cisco 1200			
AAT-CAP-1232	11-10	Wireless, Faceplate, Cisco 1232			
AAT-CAP-1242	11-10	Wireless, Faceplate, Cisco 1242			
AAT-CAP-S	11-10	Wireless, Ceiling Mounted			

<b>Description</b>	<b>Page #</b>	<b>Description</b>	<b>Page #</b>
Adjustable Bracing Kit	9-7	Cabinet Accessories	
Adjustable QuadraRack	8-14	Bottom Panel, GF-Series	1-31
Adjustable Rail QuadraRack	8-11	Bottom Panel, F-Series	1-8
Adjustable Rail ServerRack	8-11	Bottom Panel, F-Series HD	1-18
Adjustable ServerRack	8-14	Cable Lashing Bracket, F-Series	1-12
Air Dam Kit, Airflow Baffles, C-Series	1-55	Cable Lashing Bracket, GF-Series	1-34
Aisle Containment		Cable Lashing Bracket, Z4-Series	1-42
Adjustable Filler Panel, FSHAC	1-79	Cable Lashing Manager, N-Series	1-25
Adjustable Height Filler Panel, CAC	1-82	Cable Port Brush Kit, GF-Series	1-31
Build To Spec Kit	1-70	Cable Ring Manager, F-Series	1-13
Ceiling Panel Kit, CAC	1-82	Cable Ring Manager, F-Series HD	1-18
Containment Floor Seal Kit	1-67	Electronic Lock Kit, F-Series	1-14
Door Assembly	1-65	Electronic Lock Kit, GF-Series	1-36
Door Top Seal Kit	1-66	Equipment Rail Grommet Kit, GF-Series	1-30
Duct Edge Seal, HAC	1-75	Equipment Rail Grommet Kit, Z4-Series	1-40
Exhaust Duct Panel Kit, HAC	1-74	Fan Kit	1-48
Floor Mounting Template	1-65	Filtered Ventilation System	1-49
Frame Supported Exhaust Duct, FSHAC	1-78	Finger Cable Manager, F-Series	1-11
Frame Supported Exhaust Edge Seal, FSHAC	1-78	Finger Cable Manager, GF-Series	1-33
Full Height Blanking Panel, BTS	1-71	Front-To-Rear Cable Manager, GF-Series	1-33
Full Height Blanking Panel, FSHAC	1-78	Front-To-Rear Cable Manager, Z4-Series	1-41
Universal Bulb Seal, BTS	1-71	Full Height Dual PDU Bracket, Z4-Series	1-42
Universal Cabinet Panel, CAC	1-82	Full Height PDU Bracket, F-Series	1-12
Universal Cabinet Panel, FSHAC	1-79	Full Height PDU Bracket, GF-Series	1-34
AisleLok Acrycell Sealing Tape	1-57	Hardware Kits, Tapped Rail	1-60
AisleLok Under Rack Panel	1-57	HotLok Snap-In Filter Panels	1-57
Alternate Space Cable Runway	3-14	KoldLok Wave Grommet	1-58
Anchors	8-30	Leveling Feet Height Tool, GF-Series	1-34
anyServer Bracket	8-24	Lockable Storage Drawer	1-59
Base Angle	8-31	Power Strip Bracket, F-Series HD	1-18
Basic Consolidation Enclosures	11-8	Rail Adapter Kit	1-49
Build To Spec Kit	1-70	Ring Cable Manager, GF-Series	1-35
C-Series SlimFrame Cabinet	1-54	Ring Cable Manager, N-Series	1-24
Cable Distribution Spools	2-7	Ring Cable Manager, Z4-Series	1-41
Cable Strain Relief Bracket	2-37	Side Panel, F-Series	1-10
Cable Tray Bottom Insert	3-8	Side Panel, GF-Series	1-32
Cable Tray Cutting Tool	3-8	Telescoping Cable Manager, N-Series	1-24
Cabinets		Unload Ramp, F-Series HD	1-18
C-Series SlimFrame Cabinet	1-54	Vertical Cable Manager	1-50
E-Series ISP Co Location Cabinet	1-56	Vertical Cable Manager Ring Kit	1-50
F-Series TeraFrame Cabinet	1-1	Vertical Exhaust Duct, F-Series	1-8
F-Series TeraFrame HD Cabinet	1-17	Cabling Section Cover	2-23
GF-Series GlobalFrame Gen2 Cabinet	1-27	Cabling Sections, Vertical	
M-Series MegaFrame Cabinet	1-46	CCS Combination Cabling Section, Vertical	2-15
N-Series TeraFrame Gen 3 Cabinet	1-21	CCS-EFX Combination Cabling Section, Vertical	2-16
Z4-Series SeismicFrame Cabinet	1-38	Combination Vertical Cable Manager, Evolution	2-4
Cabinet Accessories		Double-Sided Cable Manager, Evolution	2-4
Air Dam Kit, F-Series	1-9	Double-Sided Cable Manager, Velocity	2-10
Air Dam Kit, F-Series HD	1-18	Double-Sided, Narrow Vertical Cabling Section	2-21
Air Dam Kit, GF-Series	1-30	GVCS Global Vertical Cabling Section	2-17
Air Dam Kit, Z4-Series	1-40	MCS Master Cabling Section, Vertical	2-13
Air Director, GF-Series	1-31	MCS-EFX Master Cabling Section, Vertical	2-14
AisleLok Acrycell Sealing Tape	1-57	Single-Sided Cable Manager, Evolution	2-4
AisleLok Under Rack Panel	1-57	Single-Sided Cable Manager, Velocity	2-9
Bolt Down Kit, F-Series HD	1-18	Single-Sided, Narrow Vertical Cabling Section	2-19

<b>Description</b>	<b>Page #</b>	<b>Description</b>	<b>Page #</b>
Cabling Sections, Horizontal		Horizontal Cable Manager, Velocity	2-28
Horizontal Cable Manager, Evolution	2-28	Horizontal Wire Panel	2-30
Horizontal Cable Manager, Velocity	2-28	HotLok Snap-In Filler Panels	1-57
Universal Horizontal Cable Manager, DS	2-29	IT-Series 600-2000V UPS	7-33
Universal Horizontal Cable Manager, SS	2-29	J-Bolt Kit	3-29
CCS Combination Cabling Section, Vertical	2-15	Keyboard Tray, 19" Full Size	8-28
Ceiling Enclosures, Switches	11-6	KoldLok Grommets	1-58
Ceiling Mounted Enclosure, Wireless,	11-11	<b>KVM</b>	
Ceiling Support Brackets	3-36	17 Inch LCD KVM Drawer	6-3
Channel Rack-To-Runway Mounting	3-23	Analog KVM Switch w/BD15 Ports	6-7
Chrome Lock Kit	11-9	Analog KVM Switch w/Cat 5/6 Ports	6-10
Containment Floor Seal Kit	1-67	Analog KVM Switch w/DB15 Ports	6-5
Cube-iT Wall Mounted Cabinet	10-12	IP KVM Switch w/BD15 Ports	6-7
Cube-iT Wall/Floor Mounted Cabinet	10-13	IP KVM Switch w/Cat 5/6 Ports	6-10
Dome Enclosure, Wireless	1-11	KVM Cables	6-12
Door Assembly, Aisle Containment	1-65	Lockable Storage Drawer	1-59, 8-25
Duplex Electrical Outlet Box	9-5	Low Profile Fixed Shelf	1-62
E-Series ISP Co Location Cabinet	1-56	LP-11U Series UPS	7-35
EasySwing Wall-Mount Rack	10-6	M-Series MegaFrame Cabinet	1-46
Electronic Lock Kit	1-14, 4-11	Mag Clips	2-38
Evolution Cable Managers	2-4	MCS Master Cabling Section, Vertical	2-13
ExpandARack	8-18	Metal D-Rings	2-36
F-Series TeraFrame Cabinet	1-1	Monitor Shelf, Single Tray	8-26
F-Series TeraFrame HD Cabinet	1-17	Mounting Brackets, 66 Block	8-41
Fiber Management Spools	2-27	N-Series TeraFrame Gen 3 Cabinet	1-21
Filler Panel	8-32	Narrow Cable Loop	2-26
Fixed Shelf	1-61	NEMA Wall-Mount Enclosures	11-12
Fixed Wall-Mount Equipment Rack	10-8	OnTrac Wire Mesh Cable Tray System	
GF-Series GlobalFrame Gen2 Cabinet	1-27	OnTrac Wire Mesh Cable Tray	3-3
Global Standard Pack	2-18	90° Splice Bar Kit, OnTrac	3-4
Global Vertical Cabling Section	2-17	Center Support Bracket, OnTrac	3-6
Grounding/Bonding		L Support Bracket, OnTrac	3-5
Busbar Assemblies	5-5	Pedestal Clamp Bracket, OnTrac	3-7
Cable Runway Insulator Bar Kit	5-8	Rack-Mount Hook, OnTrac	3-7
Compression Lugs	5-14	Standard Splice Kit, OnTrac	3-4
Ground Jumper	5-11	Trapeze Support Bracket, OnTrac	3-5
Ground Wire	5-10	Triangle Support Bracket, OnTrac	3-6
Grounding Busbars	5-3	Under Floor Support Bracket, OnTrac	3-7
Pipe Clamp with Ground Connector	5-12	Wall Mount Angle, OnTrac	3-6
Standard Busbars	5-4	PatchRack for Cable Runway 3-15	
Vertical Rack Busbar Kits	5-7	PDU Mounting Brackets, PDU	7-31
Vertical Rack Ground Bar Kit	5-6	<b>Power</b>	
C-Type Compression Taps	5-15	eConnect PDUs	7-5
GT-Series UPS	7-34	International Power Strips, Horizontal	7-29
GT-Series 8000-10000VA UPS	7-35	International Power Strips, Vertical	7-27
<b>Hardware</b>		PDU Mounting Brackets, PDU	7-31
Hardware Kit, Square-Punched	8-17	PDU Sensors	7-31
Hex Nuts	3-41	PDU, Vertical	7-20
Split Lock Washers	3-41	PDU, Horizontal	7-21
Washer, Type A Plain	3-41	PDU, Horizontal, PowerWedge	7-22
Heavy Duty Swing Gate Kit	10-5	Power Cords, IEC C20 PDU	7-30
Heavy Duty Top Angle	8-31	Power Strips	7-23
Hex Cap Bolts	3-42	PowerScope In-Line Meter	7-32
Hex Nuts	3-41	UPS	7-33
Horizontal Cable Manager, Evolution	2-28	Vertical PDU Mounting Bracket	7-28

<b>Description</b>	<b>Page #</b>	<b>Description</b>	<b>Page #</b>
Quick Ship Cable Runway	3-13	Shelves	
Rack Dolly, Mid-Size	8-33	32" D Sliding Shelf	1-63
Rack Radius Drop	2-32	Equipment Rail, 4-Post	8-16
<b>Rack Systems</b>		Extra Heavy Duty Sliding Shelf	1-63
Adjustable QuadraRack	8-14	Fixed Shelf	1-61
Adjustable Rail QuadraRack	8-11	Low Profile Fixed Shelf	1-62
Adjustable Rail ServerRack	8-11	Rack-Mount Cable Shelf	1-61
Adjustable ServerRack	8-14	Shelf, 26" D	8-21
QuadraRack 4-Post Frame	8-18	Shelf, Double-Sided	8-22
QuadraRack Server Frame	8-17	Shelf, Double-Sided, Steel	8-21
Seismic Frame 2-Post Rack	9-4	Shelf, Extra Extended	8-23
Single Rack Enclosures	8-9	Shelf, Heavy-Duty, 4-Post	8-19
Universal Rack	8-4	Shelf, Low Profile	8-20
Universal Rack, 35"	8-5	Shelf, Single Sided	8-20
Revised Floor Enclosure	11-4	Shelf, Single Sided, Vented	8-20
<b>Remote Infrastructure Management</b>		Shelf, Single-Sided, Steel	8-21
RIM-750	4-3	Shelf, Sliding Equipment	8-23
RIM-1000	4-8	Shelf, Small Peripheral	8-20
RIM Protocol Converter	4-10	Shelves, Solid, 4-Post	8-15
Sensors, RIM-1000	4-9	Shelf, Space Saving	8-28
Sensors, RIM-750	4-5	Shelves, Vented, 4-Post	8-15
<b>Runway</b>		Sliding Shelf	1-62
Universal Cable Runway	3-11	Silver Frame Wall-Mount Cabinet	10-17
TELCO Style Cable Runway	3-12	Single Rack Enclosures	8-9
UL Classified Cable Runway	3-12	Slip-On Lock Nut	3-36
45" Runway Splice Kit	3-20	Snap-In Filler Panel	1-9, 1-30
90" Runway Splice Kit	3-20	Spare Keys	11-9
Adjustable Floor Support Channel	3-33	<b>Splice Kits</b>	
Cable Runway Pathway Divides	3-14	Adjustable Junction-Splice Kit	3-20
Channel Rack-To-Runway Mounting	3-22	Butt-Splice Kit	3-18
Framing Clip	3-25	Heavy-Duty Butt-Splice Kit	3-18
J-Bolt Kit	3-27	Junction-Splice Kit	3-19
PatchRack for Cable Runway	3-15	Transition Adapter Butt-Splice Kits	3-19
Protective End Caps	3-40	Split Lock Washers	3-41
Runway E-Bend	3-17	Stand-Off Tie Bracket	2-37
Runway Radius Bend	3-17	Standard Rack	8-8
Runway Radius Drop	3-16	Standard Swing Gate Rack	10-5
Runway Support Brackets	3-36	Swivel Splice Kits	3-21
Tail Pipe Stand	3-34	TELCO Style Cable Runway	3-12
Threaded Drop Rods	3-35	ThinLine Wall Mount Cabinet	10-16
Triangular Support Bracket	3-30	Top Mount Cable Waterfall Tray, 4-Post	8-12
Trough Cable Runway	3-13	Touch-Up Paint	3-40, 8-32
Saf-T-Grip Straps	2-34	<b>Trays</b>	
<b>Seismic Products</b>		Keyboard	8-28
Adjustable Bracing Kit	9-9	Keyboard Tray, 19" Full Size	8-28
Double Earthquake Bracing Kit	9-8	Keyboard Tray, 19" Sliding	8-28
Rack Seismic Gusset Kit	9-7	Keyboard Tray, 23" w/Mouse	8-27
Seismic Equipment Bracing, Cabinets	9-9	Keyboard Tray, Flush Mount	8-27
Seismic Frame 2-Post Rack	9-4	Keyboard Tray, Flush Mount, Sliding	8-27
Seismic Frame Cabinet System	1-51	Keyboard Tray, Sliding, Single	8-26
Single Earthquake Bracing Kit	9-8	Monitor Shelf	8-26
Universal Earthquake Bracing Kit	9-6	Shelf, Space Saving	8-28
VCS Offset Mounting Bracket	9-5	UL Classified Cable Runway	3-12
Z4-Series SeismicFrame Cabinet	9-11		



<b>Description</b>	<b>Page #</b>
<u>UL Listed</u>	
45° Runway Splice Kit	3-20
90° Runway Splice Kit	3-20
90° Splice Bar Kit	3-4
Adjustable QuadraRack	8-14
Adjustable Rail QuadraRack	8-11
Adjustable Rail ServerRack	8-11
Adjustable ServerRack	8-14
Basic Consolidation Enclosures	11-8
Busbar Assemblies	5-5
Butt-Splice Kit	3-18
C-Type Compression Taps	5-15
Carriage Bolt Washer	3-4
Ceiling Enclosures, Patch Panels	11-7
Ceiling Enclosures, Switches	11-6
Ceiling Enclosures, Wiring Blocks	11-7
Clamp Washer	3-4
Compression Lugs	5-14
Cube-iT Light	10-14
Cube-iT Vertical Power Strip	10-15
Cube-iT Wall Mounted Cabinet	10-12
Universal Ground Jumper Kit	5-10
F-Series TeraFrame Cabinet	1-1
Fixed Shelf	1-61
Fixed Wall-Mount Equipment Rack	10-8
GF-Series GlobalFrame Gen2 Cabinet	1-27
Global Standard Pack	2-18
Ground Jumper	5-11
Ground Wire	5-10
Grounding Busbars	5-3
GT-Series UPS	7-34
Heavy-Duty Butt-Splice Kit	3-18
Heavy-Duty Junction-Splice Kit	3-18
Horizontal Rack Busbar	5-5
IT-Series 600-2000V UPS	7-33
Junction-Splice Kit	3-19
Low Profile Fixed Shelf	1-62
LP-11U Series UPS	7-35
MCS Master Cabling Section, Vertical	2-13
N-Series TeraFrame Gen 3 Cabinet	1-21
One Mounting Hole Ground Terminal Block	5-10
OnTrac Wire Mesh Cable Tray	3-3
Pedestal Clamp with Ground	5-12
Pipe Clamp with Ground Connector	5-12
Power Strip, Wall Enclosure	10-10
Rack Ground Jumper Kit	5-7
Raised Floor Enclosure w/Cover, Patch Panels	11-5
Raised Floor Enclosure, Active Components	11-5
Raised Floor Enclosure, Fiber	11-5
Raised Floor Enclosure, Patch Panel	11-4
Single Rack Enclosures	8-9
Splice Bar	3-4
Splice Washer & Bolt	3-4
Spring Splice Kit	3-4
Standard Busbars	5-4

<b>Description</b>	<b>Page #</b>
<u>UL Listed</u>	
Standard Rack	8-7
Standard Splice Kit, OnTrac	3-4
Standard Swing Gate Rack	10-5
TELECO Style Cable Runway	3-12
Two Mounting Hole Ground Terminal Block	5-9
UL Classified Cable Runway	3-12
Universal Cable Runway	3-11
Universal Rack	8-4
Universal Rack, 35"	8-5
Vertical Rack Busbar	5-6
VH Series UPS	7-33
Wireless, Ceiling Mounted	11-10
Wireless, Ceiling Mounted Enclosure	11-11
Wireless, Ceiling Mounted, Enclosure Kit	11-10
Wireless, Dome Enclosure	11-11
Wireless, Faceplate, Blank	11-10
Wireless, Faceplate	11-10
Wireless, Wall Mount Enclosure	11-12
Z4-Series SeismicFrame Cabinet	1-38
Universal Earthquake Bracing Kit	9-6
Universal Horizontal Cable Manager	2-29
Universal Rack	8-4
Velocity Cable Managers	2-10
VH Series UPS	7-33
<u>Wall Mount, Rack</u>	
EasySwing Wall-Mount Rack	10-6
Fixed Wall-Mount Equipment Rack	10-8
Heavy Duty Swing Gate Kit	10-5
Heavy Duty Wall-Mount Equipment Rack	10-7
Standard Swing Gate Rack	10-5
Universal Swing Gate Rack	10-4
<u>Wall-Mount, Enclosure</u>	
Wall-Mount Enclosure	10-9
Cube-iT Wall Mounted Cabinet	10-12
Cube-iT Wall/Floor Mounted Cabinet	10-13
ThinLine Wall Mount Cabinet	10-16
Silver Frame Wall-Mount Cabinet	10-17
Wall-Mount Enclosure	10-9
Washer, Type A Plain	3-41
Z4-Series SeismicFrame Cabinet	1-38, 9-11
<u>Zone Enclosures</u>	
Basic Consolidation Enclosures	11-8
Ceiling Enclosures, Patch Panels	11-7
Ceiling Enclosures, Switches	11-6
Ceiling Enclosures, Wiring Blocks	11-7
Raised Floor Enclosure w/Cover, Patch Panels	11-5
Raised Floor Enclosure, Active Components	11-5
Raised Floor Enclosure, Fiber	11-5
Raised Floor Enclosure, Patch Panel	11-4
Zone, Wall Mount Enclosure	11-13

## Catalog Includes:

- Cabinet, Containment & Enclosure Systems
- Cable Management Products
- Cable Runway & Tray Products
- Environmental Monitoring & Security Systems
- Grounding & Bonding Products
- KVM Systems
- Power Management Products
- Rack Systems
- Seismic Protection Systems
- Wall-Mount Systems
- Zone Cabling & Wireless Enclosures

US & Canada  
+1-800-834-4969  
Toronto, Ontario, Canada  
+905-850-7770  
chatsworth.com

Latin America  
+52-55-5203-7525  
Toll Free within Mexico  
01-800-01-7592  
chatsworth.com.co

Europe  
+44-1628-524-834  
chatsworthproducts.co.uk

Middle East & Africa  
Dubai, UAE  
+971-4-2602125  
chatsworthproducts.co.uk

Asia Pacific  
+86 21 6880-0266  
chatsworth.com.cn

[www.chatsworth.com](http://www.chatsworth.com)  
[techsupport@chatsworth.com](mailto:techsupport@chatsworth.com)



**CHATSWORTH  
PRODUCTS**

All products quoted are subject to availability based on manufacturing capacity and shipping dates should be considered estimates only. While every effort has been made to ensure the accuracy of all information, CPI does not accept liability for any errors or omissions and reserves the right to change information and descriptions of listed services and products. ©2015 Chatsworth Products, Inc. All rights reserved. CPI, CPI Passive Cooling, GlobalFrame, MegaFrame, Saf-T-Grip, Seismic Frame, SlimFrame, TeraFrame, Cube-iT Plus, eConnect, Evolution, OnTrac, Velocity and QuadraRack are federally registered trademarks of Chatsworth Products. Simply Efficient is a trademark of Chatsworth Products. All other trademarks belong to their respective companies. 12/14 MKT-60020-640