

DH-IPC-HFW5421E-Z

4MP HD WDR Network IR Bullet Camera



Features

- 1/3" 4Megapixel progressive scan CMOS
- Support H.264&MJPEG dual codec
- Max 20fps@4Mp(2688×1520),25/30fps@3M(2304x1296)
- Smart Detection supported
- WDR(120dB), Day/Night(ICR), 3DNR, AWB, AGC, BLC
- Multiple network monitoring: Web viewer, CMS(DSS/PSS) & DMSS
- 2.7mm ~12mm motorized lens
- 2/1 Alarm in/out, 1/1 audio in/out
- Max. IR LEDs Length 50m
- Micro SD memory, IP67, PoE

DH-IPC-HFW5421E-Z

Technical Specifications

Model	DH-IPC-HFW5421E-Z	
Camera		
Image Sensor	1/3" 4Megapixel progressive scan CMOS	
Effective Pixels	2688(H) x 1520(V)	
Scanning System	Progressive	
Electronic Shutter Speed	Auto/Manual, 1/3(4)~1/10000s	
Min. Illumination	0.01Lux/F1.4(Color),0Lux/F1.4(IR on)	
S/N Ratio	More than 50dB	
Video Output	1 port	
Camera Features		
Max. IR LEDs Length	50m	
Day/Night	Auto(ICR) / Color / B/W	
Backlight Compensation	BLC / HLC /WDR(120dB)	
White Balance	Auto/Sunny/Night/Outdoor/Customized	
Gain Control	Auto/Manual	
Noise Reduction	3D	
Privacy Masking	Up to 4 areas	
Lens		
Focal Length	2.7mm~12mm	
Max Aperture	F1.4	
Focus Control	Motorized	
Angle of View	H: 100°~33°	
Lens Type	Motorized/ Auto Iris(DC)	
Mount Type	Board-in Type	
Video		
Compression	H.264/H.264H/H.264B/MJPEG	
Resolution	4M(2688x1520)/4M(2560x1440)/3M(2304x1296)/720P(1280×720)/D1(704×576/704×480)/CIF(352×288/352×240)	
Frame Rate	Main Stream	4Mp(1~20fps)/3Mp(1 ~ 25/30fps)
	Sub Stream	D1(1 ~ 25/30fps)
	Third Stream	720P(1-20fps)
Bit Rate	H.264: 32K ~ 10Mbps	
Corridor Mode	Support	
Audio		
Compression	G.711a/ G.711u/AAC	
Interface	1/1 channel In/Out	
Smart Function		
Smart detection	Tripwire	
	Intrusion	
	Abandoned/Missing	
	Scene Change	
	Audio detect	

DH-IPC-HFW5421E-Z



	Face detect
Network	
Ethernet	RJ-45 (10/100Base-T)
Wi-Fi	N/A
Protocol	IPv4/IPv6, HTTP, HTTPS, SSL, TCP/IP, UDP, UPnP, ICMP, IGMP, SNMP, RTSP, RTP, SMTP, NTP, DHCP, DNS, PPPOE, DDNS, FTP, IP Filter, QoS, Bonjour, 802.1x
ONVIF	ONVIF, PSIA, CGI
Max. User Access	20 users
Smart Phone	iPhone, iPad, Android, Windows Phone
Auxiliary Interface	
Memory Slot	Micro SD, Max 128GB
RS485	N/A
Alarm	2/1 channel In/Out
PIR Sensor Range	N/A
General	
Power Supply	DC12V, PoE (802.3af)
Power Consumption	<11.5W (with IR on, motorized lens working)
Working Environment	-40°C ~ +60°C, Less than 95% RH
Ingress Protection	IP67
Vandal Resistance	N/A
Dimensions	272.9 mm × 94.9mm × 94.9mm
Weight	1.1kg

DH-IPC-HFW5421E-Z

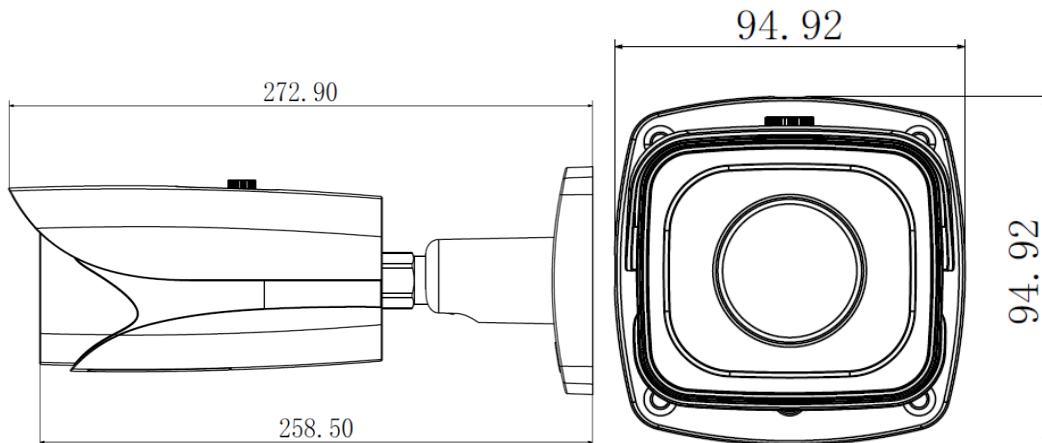
Dimensions (mm)

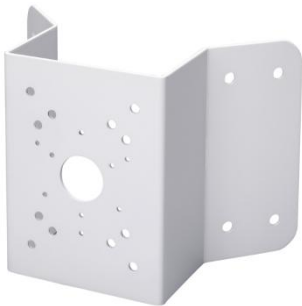

Accessory (optional)

PFA121	PFA151	PFA152
		

Dahua Technology Co., Ltd.

1199 BinAn Road, Binjiang District, Hangzhou, China

Tel: +86-571-87688883

Fax: +86-571-87688815

Email: overseas@dahuatech.com

www.dahuasecurity.com

*Design and specifications are subject to change without notice.

© 2015 Dahua Technology Co., Ltd.