



LevelOne

User Manual

ACC-2000
KVM IP Console Module

Ver. 1.1

Certificates

Ver. 1.0.0-0709

FCC

This equipment has been tested and found to comply with Part 15 of the FCC Rules.

Operation is subject to the following two conditions:

- (1) This device may not cause harmful interference
- (2) This device must accept any interference received, including interference that may cause undesired operation.

CE

This equipment is in compliance with the requirements of the following regulations: EN 55022: CLASS A

RoHS

All contents of this package, including products, packing materials and documentation comply with RoHS.



TABLE OF CONTENTS

1. The quick installation guide.....	5
1.1 Installation.....	5
1.2 Initial IP configuration	6
2. Introduction	10
2.1 Feature overview	10
2.2 System requirement.....	11
2.3 When the server is up and running.....	11
2.4 When the server is dead.....	11
3. Hardware installation	13
4.1 Initial Configuration	14
4.1.1 Initial configuration via serial console	16
4.2 Keyboard, Mouse, and Video configuration	17
4.2.1 KVM IP Console Module keyboard settings.....	17
4.2.2 Remote Mouse Settings	17
4.2.3 Automatic mouse speed and mouse synchronization.....	18
4.2.4 Host system mouse settings.....	18
4.2.5 Single and Double Mouse Mode.....	19
4.2.6 Recommended Mouse Settings.....	19
4.2.7 Video Modes.....	19
5. Usage	20
5.1 Prerequisites.....	20
5.2 Login into the KVM IP Console Module and logout.....	21
5.2.1 Login into the KVM IP Console Module	21
5.2.2 Logout from the KVM IP Console Module.....	23
5.3 The Remote Console.....	23
5.4 Main Window	24
5.4.1 Remote Console Control Bar.....	25
5.4.2 Remote Console Status Line	33
6. Menu Options	34
6.1 Remote Control.....	34
6.1.1 KVM Console.....	34
6.1.2 Telnet Console.....	35
6.2 Remote Power	36
6.3 Virtual Media.....	36
6.3.1 Floppy Disk.....	36
6.3.2 CD-ROM Image	37
6.3.3 Drive redirection	42
6.3.3.1 Driver Redirection Utility Installation	43
6.3.3.2 Built-in Java Drive Redirection	47
6.3.4 Options	49

6.4 User Management	50
6.4.1 Change Password	50
6.4.2 Users and Groups.....	50
6.5 KVM Settings	51
6.5.1 User Console.....	52
6.5.2 Keyboard/Mouse	55
6.5.3 Video	57
6.6 Device Settings.....	58
6.6.1 Network	58
6.6.2 Dynamic DNS	60
6.6.3 Security.....	62
6.6.4 Certificate	66
6.6.5 Serial Port.....	69
6.6.6 Date / Time	71
6.6.7 Event Log	72
6.7 Maintenance	74
6.7.1 Device Information.....	74
6.7.2 Even log.....	76
6.7.3 Update Firmware	76
6.7.4 Unit Reset.....	78
7. Troubleshooting	78
8. FAQs.....	79
9. Addendum.....	82
A. Key Codes.....	82
B. Video Modes	84
C. User Role Permissions.....	85
D. KVM IP Console Module port table	85
E. Bandwidth Consumption	86
F. Cable diagrams.....	87

1. The quick installation guide

The KVM IP Console Module redirects local keyboard, mouse and video data to a remote administration console. It allows you to control one or many computers locally at the server site or remotely via the Internet using a standard browser. You can securely gain BIOS level access to systems for maintenance, support, or failure recovery over the Internet. Communication is secure via SSL encryption. Use in conjunction with a KVM switch for multiple-server access.

1.1 Installation

The KVM IP Console Module works with the KVM Switch that has an expansion slot.
Ex) KVM-0831/1631, KCM-0831/1631

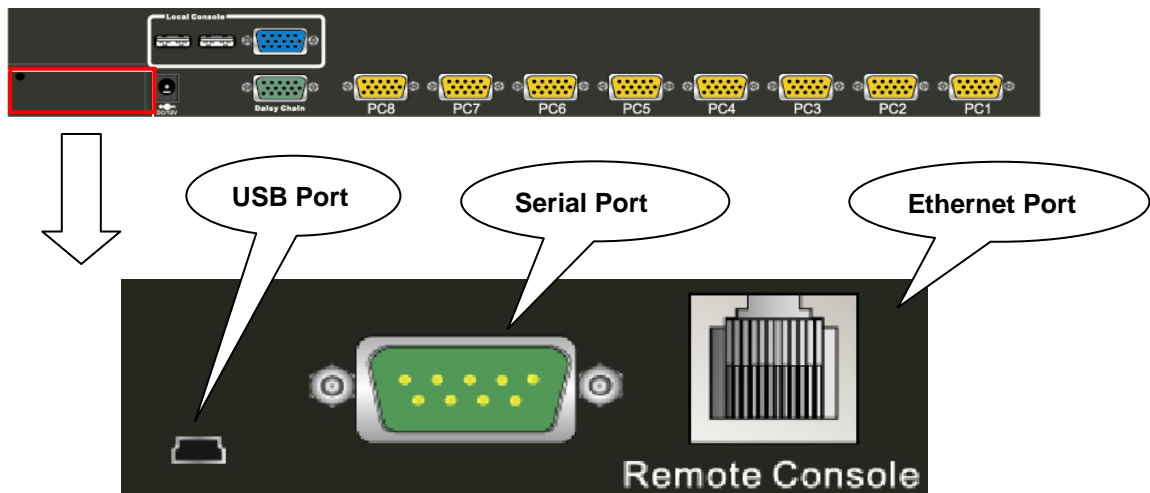

Figure 1-1 The KVM IP Console Module

Please perform the following steps:

1. (Optional) Connect the type A connector of USB A-B cable to the host computer, while using remote mass storage control.
2. Connect Ethernet to LAN port and/or modem to serial port, depending on how you want to access KVM IP Console Module switch

Please perform the following steps:

3. Power down computer and the KVM Switch
4. Remove the cover on the expansion slot from KVM Switch and carefully slide in the KVM IP Console Module into the expansion slot.
5. Connect the power supply to the KVM Switch once IP Console Module firmly installed.
6. Connect the monitor, keyboard and mouse to the KVM Switch.
7. Use VGA cable (15-pin HDDB Male / Male) connects computer and KVM Switch.

1.2 Initial IP configuration

In factory default, DHCP mode is disabled (IP auto configuration = None), and the IP settings are as below:

IP address	192.168.1.22
Subnet mask	255.255.255.0
Default Gateway	None

If DHCP mode is enabled (IP auto configuration = DHCP), the KVM IP Console Module will try to contact a DHCP server in the subnet to which it is physically connected. If a DHCP server is found, it may provide a valid IP address, gateway address and net mask. Before you connect the device to your local subnet, be sure to complete the corresponding configuration of your DHCP server. It is recommended to configure a fixed IP assignment to the MAC address of the KVM IP Console Module unit. You can find the MAC address labeled on the bottom side of the metal housing.

KVM IP Console Module Setup Tool

If this initial configuration does not meet the local requirements, please use the setup tool to discover KVM IP Console Module and change the configurations as user requested. The setup tool **IPSetup** can be found in the CD delivered with KVM Switch (KVM-0831/1631 & KCM-0831/1631). User can also download the setup tool from website at www.level1.com. Follow the procedures described below for using setup tool **IPSetup**.

■ DHCP

If you have installed the KVM IP Console Module unit on a network that enables DHCP, you can use the **IPSetup** to find out the KVM IP Console Module unit's IP.

(1) Plug Ethernet cable to KVM IP Console Module unit. KVM IP Console Module will get an IP via DHCP.

(2) Using **IPSetup** (run IPSetup.exe) to look for KVM IP Console Module.

- a. Select MAC address which label on bottom of KVM IP Console Module unit
- b. Click **Query Device**

■ Setup the fixed IP

- a. Setup “IP auto configuration” as “None” ; setup IP address and Subnet mask
- b. Enter Super user login and password for Authentication (default : super/pass)
- c. Click **Setup Device**. If super login was authenticated, it'll show “Successfully configured device”. Otherwise it'll show “Permission Denied”.

Install JVM on Client system

The KVM IP Console Module unit can be accessed with a standard JAVA enabled web browser. You must install Java Runtime Environment: version 6 update 5 and above to your

client system.

Note: At a minimum you must have IE7.0, IE8.0, Netscape7.0, Mozilla 3.2, Firefox 3.6) and above installed on your client computer.

Connect the KVM IP Console Module unit via Web Browser

Using the HTTP protocol or a secure encrypted connection via HTTPS and entering the IP address of the KVM IP Console Module unit into your web browser to connect to the KVM Switch for remote management.

This will lead you to the KVM IP Console Module login page as shown in figure below.



The factory default settings are:

Username	super
Password	pass

The super user has all permissions to administrate your KVM IP Console Module:

After login, the system will prompt for changing the default username and password to user specific settings.

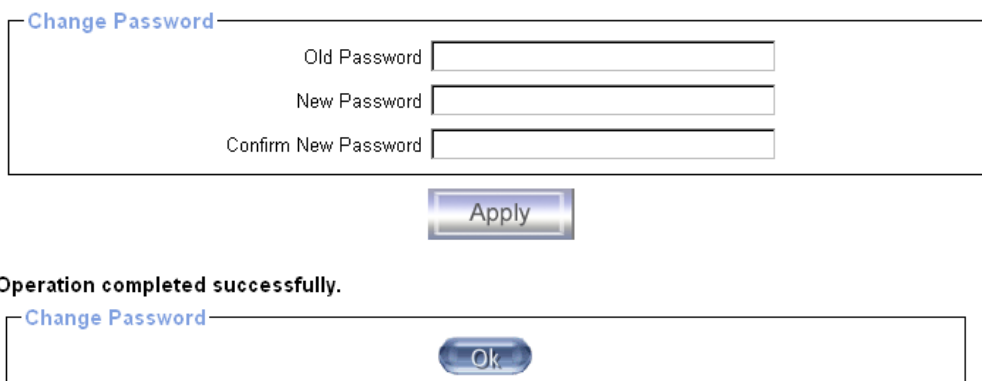

Control servers via Remote Console

The Remote Console is the redirected screen, keyboard and mouse of the remote host

system. The Remote Console will behave exactly the same way as if you were sitting directly in front of the screen of your remote system. That means that both the keyboard and mouse can be used in the usual way. Open the console by selecting the preview picture on the main site of the HTML front end. Figure 1-2 shows the top of the Remote Console.



Figure 1-2. Top part of the Remote Console

There are some options to choose from, and the important ones are the following:

Auto Adjust button 

If the video displayed is of bad quality or distorted in some way, press this button and wait a few seconds while KVM Switch unit tries to adjust itself for the best possible video quality.

Sync Mouse 

Choose this option in order to synchronize the local with the remote mouse cursor. This is especially necessary when using accelerated mouse settings on the host system. In general there is no need to change mouse settings on the host.

Video Settings in Options Menu

This opens a new window with elements to control the KVM Switch unit's Video Settings. You can change some values, for instance the brightness and contrast of the picture displayed, which may improve the video quality. It is also possible to revert to the default settings for all video modes or only the current one.

Note: At first start, if the local mouse pointer is not synchronized with the remote mouse pointer, press the Auto Adjust Button once.

2. Introduction

The KVM over IP technology (KVM Switch + IP Console Module) combines digital remote KVM access via IP networks with comprehensive and integrated system management. The KVM over IP defines a new class of remote KVM access which provides flexibility that can prevent extra costs, save times and reduce spaces, and equipment.

The KVM over IP provides convenient, remote KVM access and control via LAN or Internet. It captures, digitizes, and compresses video signal and transmits it with keyboard and mouse signals to and from a remote computer. KVM over IP provides a non-intrusive solution for remote access and control. Remote access and control software runs on its embedded processors only but not on mission-critical servers, so that there is no interference with server operation or impact on network performance.

The KVM IP Console Module will automatically detect the current video mode of the console, however manual fine-tuning is recommended to receive the best video quality.

2.1 Feature overview

- Remotely access computers via LAN, WAN or the Internet.
- KVM access over IP and analogous telephone line (modem needed).
- Full control under any OS, in BIOS mode, during boot, at Blue Screens
- No additional software necessary on servers
- 256 bit SSL encryption of all transmitted data and Certificate management
- Automatically senses video resolution for best possible screen capture
- High-performance mouse tracking and synchronization
- Automatic adjustment of data rate to transmission line
- Remote mass storage control
- Control over all java-enabled Browsers
- Firmware update via web interface

2.2 System requirement

Hardware

Item	Description
Local host side	KVM switch unit (KVM-0831, KVM-1631, KCM-0831, KCM-1631)
Remote Console side	One PC or Multiple PCs are linked into the network

Software

Item	Description
Local host side	No additional software necessary
Remote Console side	(1) Java Runtime Environment : version 6 update 5 and above. Linux JDK 1_5_0_18 and above (2) Browser: (IE7.0 , IE8.0, Netscape7.0, Mozilla 3.2, Firefox 3.6) and above.

2.3 When the server is up and running

The KVM IP Console Module gives you a full control over the remote server. The Management Console allows you to access the remote server's graphics, keyboard and mouse and to send special commands to the server. You can also perform periodic maintenance of the server. Using the Console Redirection Service, you are able to do the following:

- I. Reboot the system
- II. Watch the boot process.
- III. Boot the system from a separate partition to load the diagnostic environment.
- IV. Run special diagnostic programs.

2.4 When the server is dead

Obviously, fixing hardware defects is not possible through a remote management device. Nevertheless KVM IP Console Module gives the administrator valuable information about the type of a hardware failure. Serious hardware failures can be categorized into five different categories with different chances to happen:

- I. Hard disk failure 50%
- II. Power cable detached, power supply failure 28%
- III. CPU, Controller, main board failure 10%
- IV. CPU fan failure 8%
- V. RAM failure 4%

Using KVM IP Console Module, administrators can determine which kind of serious hardware failure has occurred (See table 2-1).

Type of failure	Detected by
Hard disk failure	Console screen, CMOS set-up information
Power cable detached, power supply failure	Server remains in power off state after power on command has been given.
CPU Controller, main board failure.	Power supply is on, but there is no video output.
CPU fan failure	By server specific management software
RAM failure	Boot-Sequence on boot console

Table 2-1. Host system failures and how they are detected.

3. Hardware installation

The KVM IP Console Module switch redirects local keyboard, mouse and video data to a remote administration console. It allows you to control one or many computers locally at the server site or remotely via the Internet using a standard browser. You can securely gain BIOS level access to systems for maintenance, support, or failure recovery over the Internet. Communication is secure via SSL encryption. Use in conjunction with a KVM switch for multiple-server access.

3.1 Installation

The KVM IP Console Module works with the KVM Switch that has an expansion slot.
Ex) KVM-0831/1631, KCM-0831/1631

Below is a diagram illustrating KVM-0831 and ACC-2000

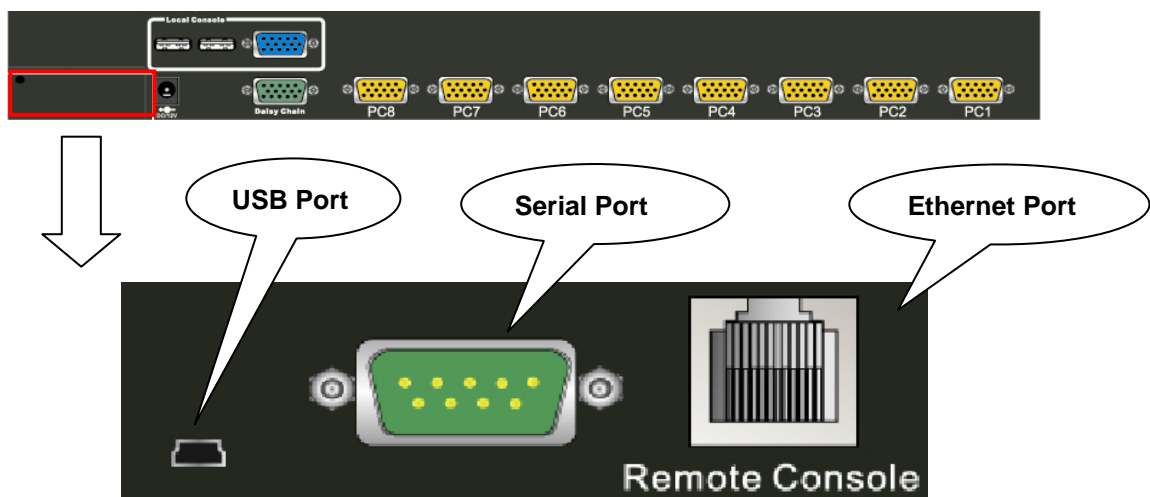

Please perform the following steps:

1. (Optional) Connect the type A connector of USB A-B cable to the host computer, while using remote mass storage control.
2. Connect Ethernet to LAN port and/or modem to serial port, depending on how you want to access KVM IP Console Module switch

Please perform the following steps:

3. Power down computer and the KVM Switch
4. Remove the cover on the expansion slot from KVM Switch and carefully slide in the KVM IP Console Module into the expansion slot.
5. Connect the power supply to the KVM Switch once IP Console Module firmly installed.
6. Connect the monitor, keyboard and mouse to the KVM Switch.
7. Use VGA cable (15-pin HDDDB Male / Male) connects computer and KVM Switch.

4. Configuration

4.1 Initial Configuration

If DHCP mode is enabled (IP auto configuration = DHCP), the KVM IP Console Module will try to contact a DHCP server in the subnet to which it is physically connected. If a DHCP server is found, it may provide a valid IP address, gateway address and net mask. Before you connect the device to your local subnet, be sure to complete the corresponding configuration of your DHCP server. It is recommended to configure a fixed IP assignment to the MAC address of the KVM IP Console Module. You can find the MAC address labeled on the bottom side of the metal housing.

If DHCP mode is disabled (IP auto configuration = None), the factory default IP settings are as below:

IP address	192.168.1.22
Subnet mask	255.255.255.0
Default Gateway	None

Table 4-1 Initial Network Configurations

KVM IP Console Module Setup Tool

If this initial configuration does not meet your local requirements, use the setup tool to change the configurations to your needs. The setup tool **IPSetup** can be found on the CD ROM delivered with this package. You can follow the procedures described below.

■ DHCP

If you have installed the KVM IP Console Module on a network that enables DHCP, you can use the **IPSetup** to find out the KVM IP Console Module's IP.

(1) Plug Ethernet cable to KVM IP Console Module. KVM IP Console Module will get an IP via DHCP.

(2) Using **IPSetup** (run IPSetup.exe) to look for KVM IP Console Module.

- a. Select MAC address which label on bottom of KVM IP Console Module
- b. Click **Query Device**

Notes:

- **BOOTP**, a static configuration protocol, uses a table that maps IP addresses to physical addresses.
- **DHCP**, an extension to BOOTP that dynamically assigns configuration information. DHCP is backward compatible with BOOTP.

Device Setup 1.1.0

Device

Device MAC address: 00:11:6B:A0:55:EA

 Device Type:
 Enable WLAN Configuration (WLAN Devices only)

Network Configuration

IP auto configuration: None DHCP BOOTP
 IP address:
 Subnet mask:
 Gateway:

Authentication

Super User login:
 Super User password: ?
 New Super User password:
 New password (confirm):

Wireless LAN Configuration

Wireless LAN ESSID:
 Enable WEP encryption
 WLAN WEP Key:

Status: Found 1 devices (1 network, 0 USB)

■ Setup fixed IP

- a. Setup "IP auto configuration" as "**None**"; setup IP address and Subnet mask
- b. Enter Super user login and password for Authentication (default : super/pass)
- c. Click **Setup Device**. If super login was authenticated, it'll show "Successfully configured device". Otherwise it'll show "Permission Denied".

Device Setup 1.1.0

Device

Device MAC address: 00:11:6B:A0:55:EA

 Device Type:
 Enable WLAN Configuration (WLAN Devices only)

Network Configuration

IP auto configuration: None DHCP BOOTP
 IP address:
 Subnet mask:
 Gateway:

Authentication

Super User login: super
 Super User password: ****
 New Super User password:
 New password (confirm):

Status: Ready.

Information

Successfully configured device.

Authentication

To adjust the authentication settings, enter your login as a super user, and change your password.

Super user login

Enter the login name of the super user. The initial value is “**super**”. All characters are in lower case.

Super user password

Enter the current password for the super user. This initial value is “**pass**”. All characters are in lower case.

New super user password

Enter the new password for the super user.

New password (confirm)

Re-type the new password for the super user for confirmation.

To close the window and accept the changes, press the “OK” button; otherwise press the “Cancel” button.

4.1.1 Initial configuration via serial console

For using serial terminal, the KVM IP Console Module has a serial line interface (host side). This connector is compliant with the RS-232 serial line standard. The serial line has to be configured with the parameters given in Table 4-2.

When configuring with a serial terminal, e.g., Hyper Terminal, reset the KVM IP Console Module and immediately press the “ESC” key. You will see some device information, and a “=>” prompt. Enter “config”, press “Enter” key and wait for a few seconds for the configuration questions to appear.

Parameter	Value
Bits/second	115200
Data bits	8
Parity	No
Stop bits	1
Flow Control	None

Table 4-2. Serial line parameters

As you proceed, the following questions will appear on the screen. To accept the default values shown in square brackets below, press “Enter” key.

IP auto configuration (none/dhcp/bootp):

IP [192.168.1.22]:

Net mask [255.255.255.0]:

Gateway (0.0.0.0 for none) [0.0.0.0]:

IP auto-configuration

With this option, you can specify whether the KVM IP Console Module should get its network settings from a DHCP or BOOTP server. For DHCP, enter “dhcp”, and for BOOTP enter “bootp”. If you do not specify any of these, the IP auto-configuration is disabled and subsequently you will be asked for the following network settings.

IP address

The IP address the KVM IP Console Module. This option is only available if IP auto-configuration is disabled.

Net mask

The net mask of the connected IP subnet. This option is only available if IP auto-configuration is disabled.

Gateway address

The IP address of the default router for the connected IP subnet. If you do not have a default router, enter 0.0.0.0. This option is only available if IP auto-configuration is disabled.

4.2 Keyboard, Mouse, and Video configuration

Between the KVM IP Console Module and the host, there are two interfaces available for transmitting keyboard and mouse data: USB and PS/2. The correct operation of the remote mouse depends on several settings which will be discussed in the following subsections.

4.2.1 KVM IP Console Module keyboard settings

The KVM IP Console Module settings for the host's keyboard type have to be corrected in order to make the remote keyboard work properly. Check the settings in the KVM IP Console Module Web front-end. See section 6.5.2 for details.

4.2.2 Remote Mouse Settings

A common seen problem with KVM devices is the synchronization between the local and remote mouse cursors. The KVM IP Console Module addresses this situation with an intelligent synchronization algorithm. There are two mouse modes available on the KVM IP Console Module:

Auto mouse speed

The automatic mouse speed mode tries to detect the speed and acceleration settings of the host system automatically. See the section below for a more detailed explanation.

Fixed mouse speed

This mode just translates the mouse movements from the Remote Console in a way that one pixel move will result in n-pixel moves on the remote system. This parameter n is adjustable with the scaling. Please note that this works only when mouse acceleration is turned off on the remote system.

4.2.3 Automatic mouse speed and mouse synchronization

The automatic mouse speed mode performs the speed detection during mouse synchronization. Whenever the local and remote mouse cursors move synchronously or not, there are two ways for re-synchronizing local and remote mouse cursors:

Fast Sync

The fast synchronization is used to correct a temporary, but fixed skew. Choose the option using the Remote Console options menu or press the mouse synchronization hotkey sequence in case you defined one.

Intelligent Sync

If the fast sync does not work or the mouse settings have been changed on the host system, use the intelligent resynchronization. This method takes more time than the fast one and can be accessed with the appropriate item in the Remote Console option menu. The intelligent synchronization requires a correctly adjusted picture. Use the auto adjustment function to setup the picture, and make sure that there are no window at the top left corner of the remote desktop that are able to change the mouse cursor shape from the normal state. The Sync mouse button on top of the Remote Console can behave differently, depending on the current state of mouse synchronization. Usually pressing this button leads to a fast sync, except in situations where the KVM port or the video mode changed recently.

Note: At first start, if the local mouse pointer is not synchronized with the remote mouse pointer, press the Auto Adjust Button once.

4.2.4 Host system mouse settings

The host's operating system knows various settings from the mouse driver.

Warning

The following limitations do not apply in case of USB and Mouse Type "Windows >= 2000, MacOSX".

While the KVM IP Console Module works with accelerated mice and is able to synchronize the local with the remote mouse pointer, there are the following limitations, which may prevent this synchronization from working properly:

Special Mouse Driver

There are mouse drivers that influence the synchronization process and lead to desynchronized mouse pointers. If this happens, make sure you do not use a special vendor-specific mouse driver on your host system.

Windows XP Mouse Settings

Windows XP knows a setting named “improve mouse acceleration”, which has to be deactivated.

Active Desktop

If the Active Desktop feature of Microsoft Windows is enabled do not use a plain background. Instead, use some kind of wallpaper. As an alternative, you could also disable the Active Desktop completely.

Navigate your mouse pointer into the upper left corner of the applet screen and move it slightly forth and back. Thus the mouse will be resynchronized. If re-synchronizing fails, disable the mouse acceleration and repeat the procedure.

4.2.5 Single and Double Mouse Mode

The information above applies to the Double Mouse Mode, where remote and local mouse pointers are visible and need to be synchronized. The KVM IP Console Module also features another mode, the Single Mouse Mode, where only the remote mouse pointer is visible. Activate this mode in the open Remote Console and click into the window area. The local mouse pointer will be hidden and the remote one can be controlled directly. To leave this mode, it is necessary to define a mouse hotkey in the Remote Console Settings Panel. Press this key to free the captured local mouse pointer.

4.2.6 Recommended Mouse Settings

For the different operating systems we can give the following advice:

MS Windows 2000/2003 (Professional and Server) and XP (all versions)

In general, we recommend the usage of a mouse via USB. Choose USB without Mouse Sync. For a PS/2 mouse choose Auto Mouse Speed. For XP disable the option “enhance pointer precision” in the Control Panel.

SUN Solaris

Adjust the mouse settings either via `xset m 1` or use the CDE Control Panel to set the mouse to “1:1, no acceleration”. As an alternative you may also use the Single Mouse Mode.

MAC OS X

We recommend using the Single Mouse Mode.

4.2.7 Video Modes

The KVM IP Console Module recognizes a limited number of common video modes. When running X11 on the host system, please do not use any custom mode lines with special video modes. If you do, the KVM IP Console Module may not be able to detect them. We recommend using any of the standard VESA video modes, instead.

5. Usage

5.1 Prerequisites

The KVM IP Console Module features an embedded operating system and applications offering a variety of standardized interfaces. This chapter will describe both these interfaces, and the way to use them in a more detailed manner. The interfaces are accessed using the TCP/IP protocol family, thus they can be accessed using the LAN port of the device.

The following interfaces are supported:

HTTP/HTTPS

Full access is provided by the embedded web server. The KVM IP Console Module environment can be entirely managed using a standard web browser. You can access the KVM IP Console Module using the insecure HTTP protocol, or using the encrypted HTTPS protocol. Whenever possible, use HTTPS.

Telnet

A standard Telnet client can be used to access an arbitrary device connected to the KVM IP Console Module 's serial port via a terminal mode.

The primary interface of the KVM IP Console Module is the HTTP interface. This is covered extensively in this chapter. Other interfaces are addressed in subtopics.

In order to use the Remote Console window of your managed host system, the browser has to come with a Java Runtime Environment version 1.4.2 or above. If the browser has no Java support (such as on a small handheld device), you are still able to maintain your KVM IP Console Module using the administration forms displayed by the browser itself.

For an insecure connection to the KVM IP Console Module, we can recommend the following browsers:

- Microsoft Internet Explorer version 6.0 or higher on Windows 2000 and Windows XP
- Netscape Navigator 7.0 or Mozilla 1.6 on Windows 2000, Windows XP, Unix, Linux and UNIX-like Operating Systems

In order to access the remote host system using a securely encrypted connection, you need a browser that supports the HTTPS protocol. Strong security is only assured by using a key length of 256 Bit. Some of the old browsers do not have a strong 256 Bit encryption algorithm.

Using the Internet Explorer, open the menu entry “?” and “Info” to read about the key length that is currently activated. The dialog box contains a link that leads you to information on how to upgrade your browser to a state of the art encryption scheme. Figure 5-1 shows the dialog box presented by the Internet Explorer 6.0.



Figure 5-1. The Internet Explorer displaying the encryption key length

Newer web browsers generally support strong encryption on default.

5.2 Login into the KVM IP Console Module and logout

5.2.1 Login into the KVM IP Console Module

Launch your web browser. Direct it to the address of your KVM IP Console Module, which you configured during the installation process. The address used might be an IP address or a domain name, in the case where you have given your KVM IP Console Module a symbolic name in the DNS. For instance, type the following in the URL field of your browser when establishing an unsecured connection:

`http://<IP address of KVM IP Console Module >`

When using a secure connection, type in:

`https://<IP address of KVM IP Console Module >`

This will lead you to the KVM IP Console Module login page as shown in Figure 5-2.

Figure 5-2. Login screen

The KVM IP Console Module has a built-in super user that has all permissions to administrate your KVM IP Console Module:

Username	super (factory default)
Password	pass (factory default)

Table 5-1. Standard user settings

Warning

The user “super” is not allowed to login via the serial interface of the KVM IP Console Module.

Warning

Please make sure to change the super user password immediately after you have installed and accessed your KVM IP Console Module for the first time. Unchanging of the password for the super user is a severe security risk and might result in unauthorized access to the KVM IP Console Module and to the host system including all possible consequences!

Warning

Your web browser has to accept cookies, or else login is not possible.

Navigation

Having logged into the KVM IP Console Module successfully, the main page of the KVM IP Console Module appears (see Figure 5-3). This page consists of three parts; each of them contains specific information. The buttons on the upper side allow you to navigate within the front end (see Table 5-2 for details). Within the right frame, task-specific information is displayed that depends on the section you have chosen before.

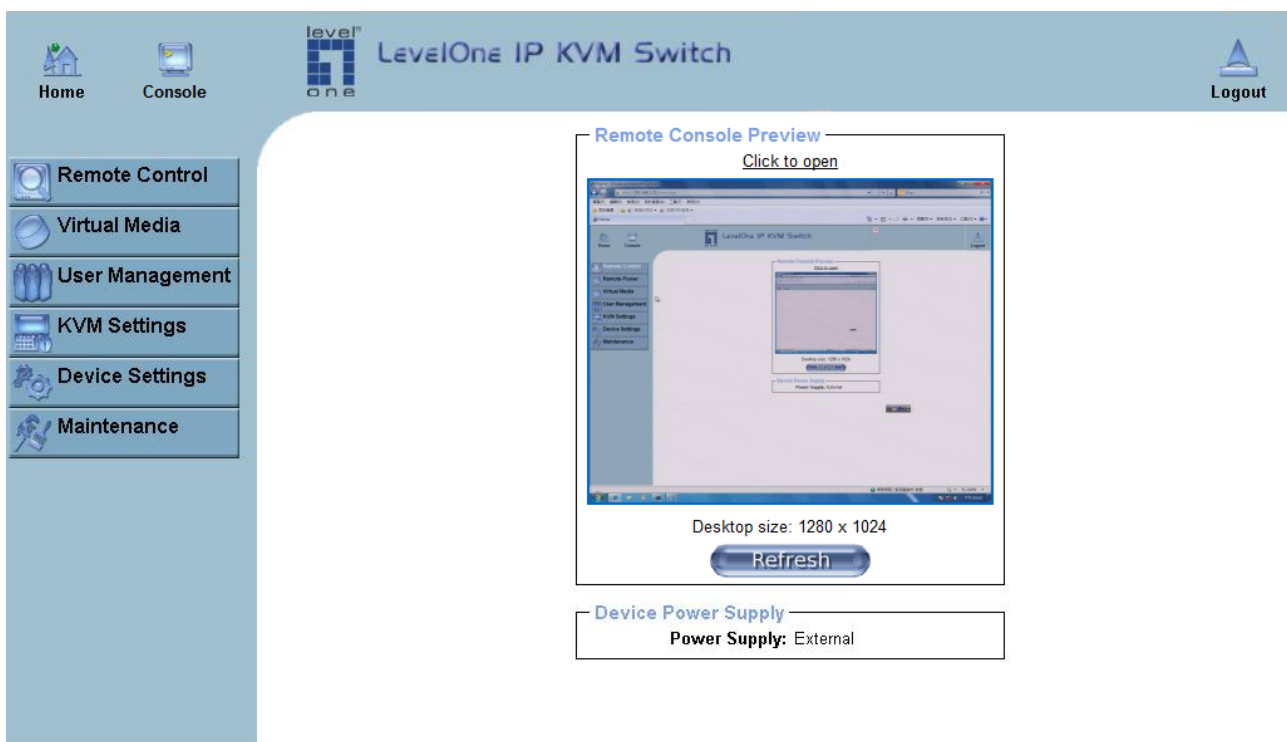

Figure 5-3. Main page



 Home	Return to the main page of the KVM IP Console Modul .
 Console	Open the KVM IP Console Modul remote console.
 Logout	Exit from the KVM IP Console Modul front end.

Table 5-2. Buttons from the front end

Warning

If there is no activity for 30 minutes, the KVM IP Console Modul will log you out, automatically. A click on one of the links will bring you back to the login screen.

5.2.2 Logout from the KVM IP Console Module

This link logs out the current user and presents a new login screen. Please note that an automatic logout will be performed in case there is no activity for 30 minutes.

5.3 The Remote Console

The Remote Console is the redirected screen, keyboard and mouse of the remote host system that KVM IP Console Module controls.

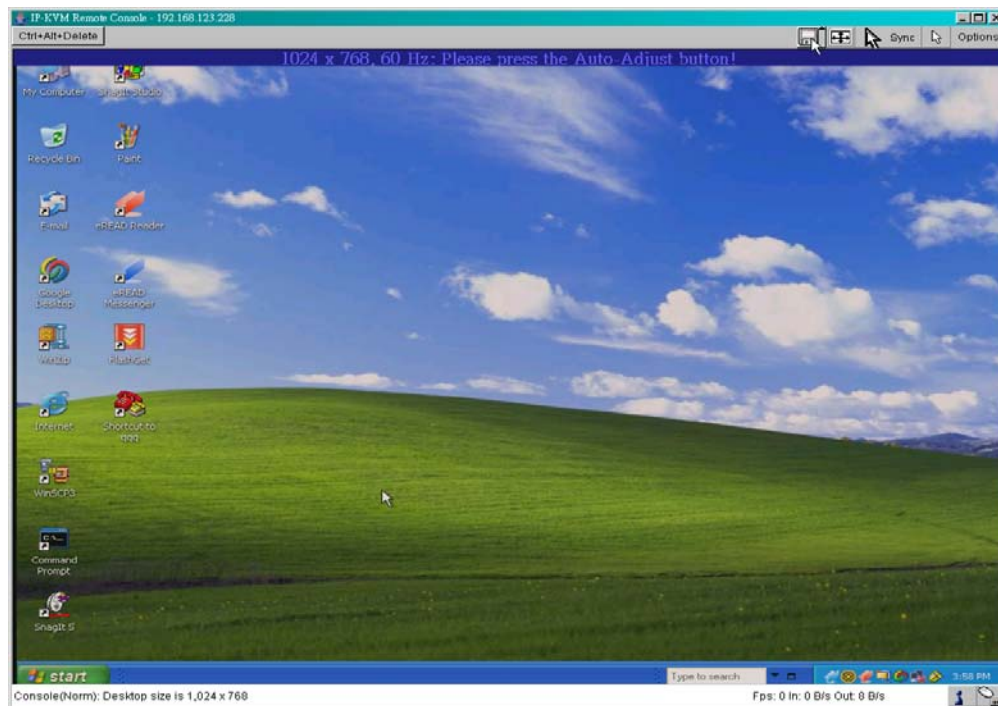

Figure 5-4. Remote Console

The Remote Console window is a Java Applet that tries to establish its own TCP connection to the KVM IP Console Module. The protocol that is run over this connection is neither HTTP or HTTPS, but RFB (Remote Frame Buffer Protocol). As default, RFB tries to establish a connection to TCP port number 443. Your local network environment has to allow this connection to be made, i.e. your firewall and, in case you have a private internal network, your NAT (Network Address Translation) settings have to be configured accordingly.

In case the KVM IP Console Module is connected to your local network environment and your connection to the Internet is available using a proxy server only without NAT being configured, the Remote Console is very unlikely to be able to establish the desired connection. This is because today's web proxies are not capable of relaying the RFB protocol.

In case of problems, please consult your network administrator in order to provide an appropriate networking environment.

5.4 Main Window

Starting the Remote Console opens an additional window. It displays the screen content of your host system. The Remote Console will behave exactly in the same way as if you were sitting locally in front of the screen of your remote system. That means keyboard and mouse can be used in the usual way. However, be aware of the fact that the remote system will react to keyboard and mouse actions with a slight delay. The delay depends on the bandwidth of the link to which you use to connect to the KVM IP Console Module.

With respect to the keyboard, the very exact remote representation might lead to some confusion as your local keyboard changes its keyboard layout according to the remote host system. If you use a German administration system, and your host system uses a US English keyboard layout, for instance, special keys on the German keyboard will not work as expected. Instead, the keys will result in their US English counterpart. You can circumvent such problems by adjusting the keyboard of your remote system to the same mapping as your local one.

The Remote Console window always tries to show the remote screen with its optimal size. That means it will adapt its size to the size of the remote screen initially and after the screen resolution of the remote screen has been changed. However, you can always resize the Remote Console window in your local window system as usual.

Warning

In difference to the remote host system, the Remote Console window on your local window system is just one window among others. In order to make keyboard and mouse work, your Remote Console window must have the local input focus.

5.4.1 Remote Console Control Bar

The upper part of the Remote Console window contains a control bar. Using its elements you can see the state of the Remote Console and adjust the local Remote Console settings. A description for each control follows.



Figure 5-5. Remote Console Control Bar

Ctrl+Alt+Delete

A rectangular button with a light beige background and a thin border. The text 'Ctrl+Alt+Delete' is centered on the button in a dark grey font.

Special button key to send the “Control Alt Delete” key combination to the remote system (see also section 6.4.1 for defining new button keys).

Auto Adjust button



If the video display is of bad quality or distorted in some way, press this button and wait a few seconds while the KVM IP Console Module tries to detect the video mode of VGA port to the controlled host and adjust itself for the best possible video quality.

Sync mouse

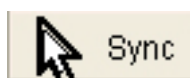

Activates the mouse synchronization process. Choose this option in order to synchronize the local with the remote mouse cursor. This is especially necessary

when using accelerated mouse settings on the host system. In general, there is no need to change mouse settings on the host.

Single/Double mouse mode 

Switches between the Single Mouse Mode (where only the remote mouse pointer is visible) and the Double Mouse Mode (where remote and local mouse pointers are visible and need to be synchronized). Single mouse mode is only available if using SUN JVM 1.4.2 or higher.

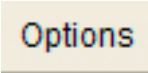
Options 

To open the Options menu, click on the button “Options”.

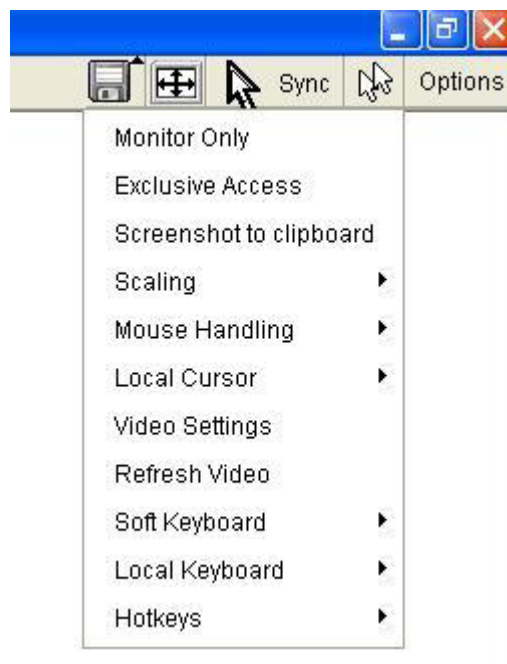

Figure 5-6. Remote Console Options Menu

A short description of the options follows.

- **Monitor Only**

Toggles the Monitor only filter on or off. If the filter is switched on no remote console interaction is possible, and monitoring is possible.

- **Exclusive Access**

If a user has the appropriate permission, he or she can force the Remote Consoles of all other users to close. No one can open the Remote Console at the same time again until this user disables the exclusive access, or logs off.

A change in the access mode is also visible in the status line (see Figure 5-7).



Figure 5-7. Remote Console Exclusive Mode

- **Scaling**

Allow you to scale down the Remote Console. You can still use both mouse and keyboard, however the scaling algorithm will not preserve all display details.

When you designate 25%, 50%, or 100% scaling, the size of Remote Console window is calculated according to the remote host video setting with scaling algorithm execution. When you designate “Scale to fit”, the remote video displaying is scaled to fit the size of Remote Console window.

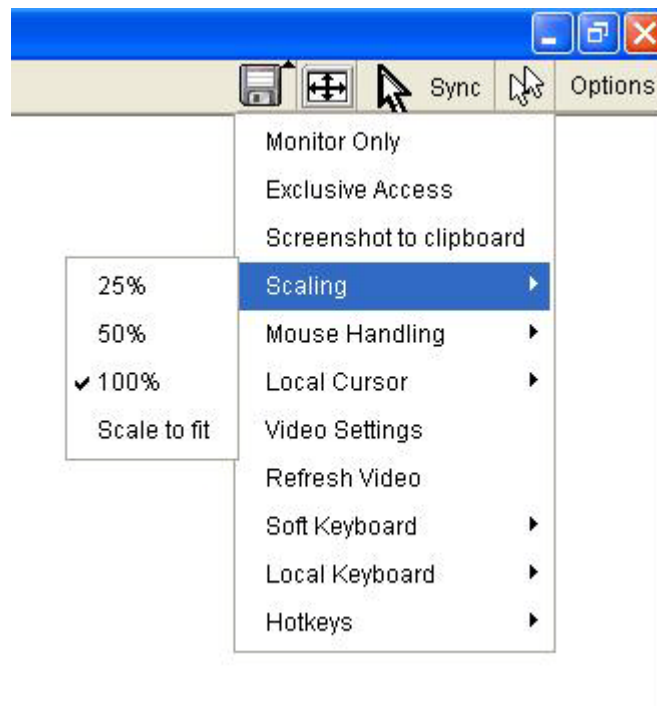

Figure 5-8. Remote Console Options Menu:Scaling

- **Mouse Handling**

The submenu for mouse handling offers two options for synchronizing the local and the remote mouse cursors.

Fast Sync --

The fast synchronization is used to correct a temporary, but fixed skew.

Intelligent Sync --

Use this option if the fast sync does not work or the mouse settings have been changed on the host system.

Warning

This method takes more time than the fast one and requires a correctly adjusted picture. Use the auto adjustment function to setup the picture.

- **Local Cursor**

Offers a list of different cursor shapes to choose from for the local mouse pointer. The selected shape will be saved for the current user and activated the next time this user opens the Remote Console. The number of available shapes depends on the Java Virtual Machine; a version of 1.4.2 or above offers the full list.

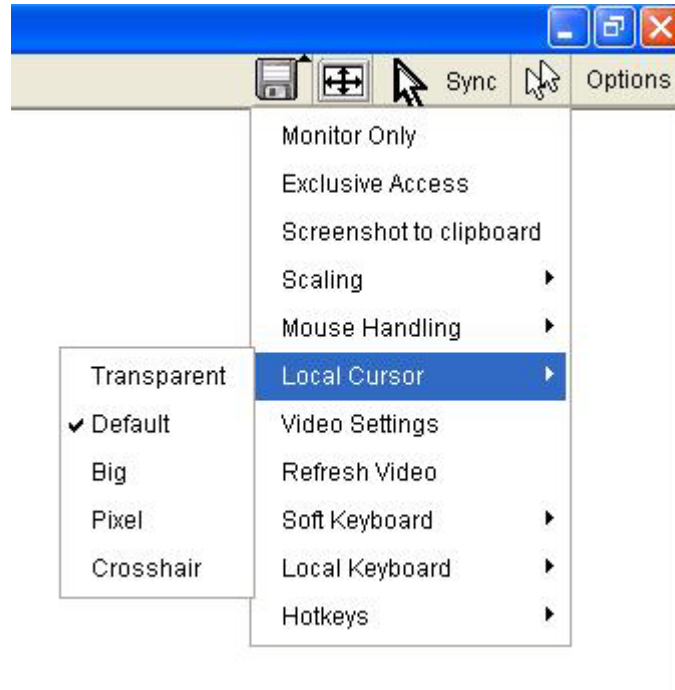

Figure 5-9. Remote Console Options Menu:Cursor

- **Video Settings**

Opens a panel for changing the KVM IP Console Module video settings. KVM IP Console Module features two different dialogs, which for adjusting the video settings.

Video Settings through the HTML-Frontend

To enable local video port, select this option. This option decides if the local video output of KVM IP Console Module is active and passing through the incoming signal from the host system.

The option Noise Filter defines how KVM IP Console Module reacts to small changes in the video input signal. Turning on the noise filter can help reduce video flickering that is often caused by distortions, as well as lowering unnecessary bandwidth consumption. A large filter setting needs less network traffic and leads to a faster video display, but small changes in some display regions may not be recognized immediately. A small filter displays all changes instantly but may lead to a constant amount of network traffic even if display content is not really changing (depending on the quality of the video input signal). All in all the default setting should be suitable for most situations.

Video Settings through the remote console

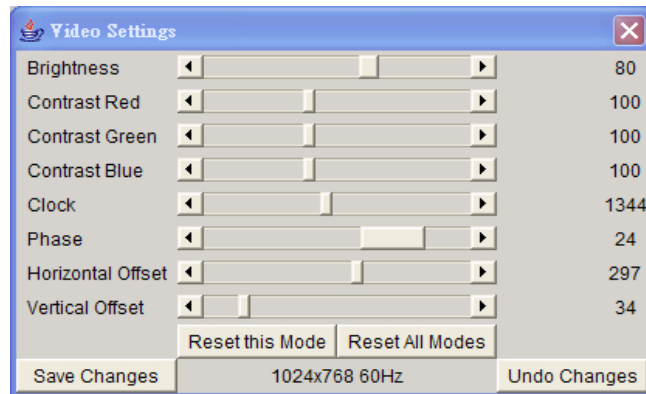

Figure 5-10. Video Settings Panel

Brightness Controls the brightness of the picture

Contrast Controls the contrast of the picture

Clock Defines the horizontal frequency for a video line and depends on the video mode. Different video card types may require different values here. The default settings in conjunction with the auto adjustment procedure should be adequate for all common configurations. If the picture quality is still bad after auto adjustment you may try to change this setting together with the sampling phase to achieve a better quality.

Phase Defines the phase for video sampling, used to control the display quality together with the setting for sampling clock.

Horizontal Position Use the left and right buttons to move the picture in horizontal direction while this option is selected.

Vertical Position Use the left and right buttons to move the picture in vertical direction while this option is selected.

Reset this Mode Reset mode specific settings (Clock , Phase and Position) to the factory-made defaults.

Reset all Modes Reset all settings to the factory-made defaults.

Save changes Save changes permanently

Undo Changes Restore last settings

- **Refresh Video**

Click to run this menu item for retrieving the whole video again from the controlled host and displayed on Remote Console. In normal situation, only changed parts of video will be packed and sent from KVM IP Console Module, for

saving network bandwidth. This function is mainly used for troubleshooting purpose where some old video fragments are displayed as not updated in time for some reason; for example, noise filter for VGA is setting too large.

- **Soft Keyboard**



Figure 5-11. Soft Keyboard

Opens up the Menu for the Soft-Keyboard.

- **Show**

Pops up the Soft-Keyboard. The Soft-Keyboard is necessary in case your host system runs a completely different language and country mapping than your administration machine.

- **Mapping**

Used for choosing the specific language and country mapping of the Soft-Keyboard.



Figure 5-12. Soft Keyboard Mapping

- **Local Keyboard**

Used to change the language mapping of your browser machine running the Remote Console Applet. Normally, the applet determines the correct value automatically. However, depending on your particular JVM and your browser settings this is not always possible. A typical example is a German localized

system that uses an US-English keyboard mapping. In this case you have to change the Local Keyboard setting to the right language, manually.

- **Hotkeys**

Opens a list of hotkeys defined before. Choose one entry, the command will be sent to the host system.

A confirmation dialog can be added that will be displayed before sending the selected command to the remote host. Select "OK" to execute the command on the remote host.

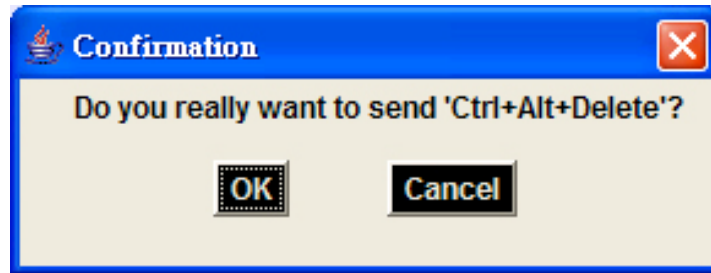

Figure 5-13. Remote Console Confirmation Dialog

- **Encoding**

These options are used to adjust the encoding level in terms of compression and color depth. They are only available unless "Transmission Encoding" is determined automatically (see the Section called *Transmission Encoding* in Chapter 6).

Compression Level: you may select a value between 1 and 9 for the desired compression level with level 1 enabling the fastest compression and level 9 the best compression. The most suitable compression level should always be seen as a compromise between the network bandwidth that is available, on your video picture to be transferred, and on the number of changes between two single video pictures. We recommend to use a higher compression level if the network bandwidth is low. The higher the compression level the more time is needed to pack and unpack the video data on either side of the connection. The compression quality depends on the video picture itself, e.g. the number of the colors or the diversity of pixels. The lower the compression quality, the more data have to be sent and the longer it may take to transfer the whole video picture.

If level 0 is chosen the video compression is disabled, completely.

The option "Video Optimized" has its advantages if transferring high-quality motion pictures. In this case the video compression is disabled, completely and all video data is transferred via network as full-quality video snippets. Therefore, a high amount of bandwidth is required to ensure the quality of

the video picture.

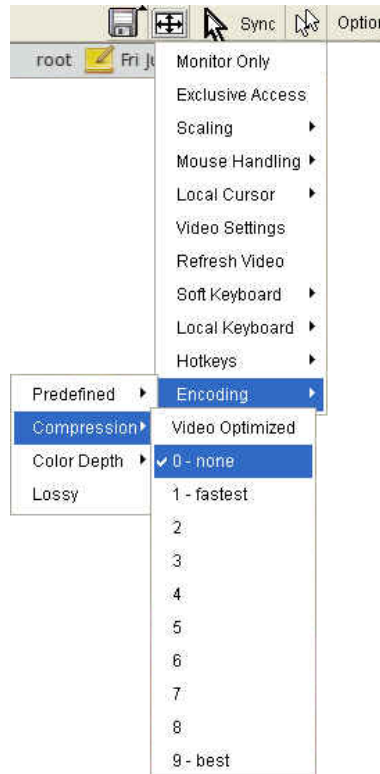

Figure 5-14. Encoding Compression

Color Depth: set the desired color depth. You may select between 8 or 16 bit for Video Optimized/compression level 0, or between 1 and 8 bit for compression level 1 to 9. The higher the color depth, the more video information has to be captured and to be transferred.

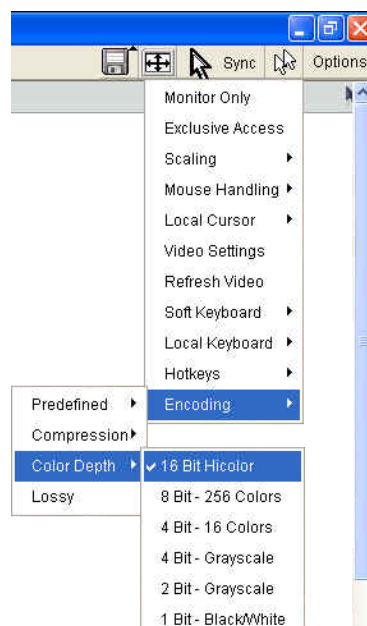

Figure 5-14. Encoding Color depth

Note: If displaying motion pictures on a connection with low speed you may achieve an improvement regarding the video transfer rate by lowering the color depth and disabling the option "Video Optimized". As a general result, the data rate is reduced (less bits per color). Furthermore, the KVM IP Console Module will not have to do any video compression. In total, this will lead to less transfer time of the motion picture.

5.4.2 Remote Console Status Line

Status line

Shows both console and the connection state. The size of the remote screen is displayed. Figure 5-15 was taken from a Remote Console with a resolution of 800x600 pixels. The value in brackets describes the connection to the Remote Console. "Norm" means a standard connection without encryption, "SSL" means a secure connection.



Figure 5-15. Status line

Furthermore, both the incoming ("In:") and the outgoing ("Out:") network traffic are visible (in kb/s). If compressed encoding is enabled, a value in brackets displays the compressed transfer rate.

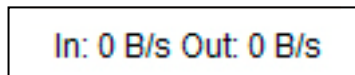

Figure 5-16. Status line transfer rate

For more information about Monitor Only and Exclusive Access settings, see related sections

6. Menu Options

6.1 Remote Control

6.1.1 KVM Console

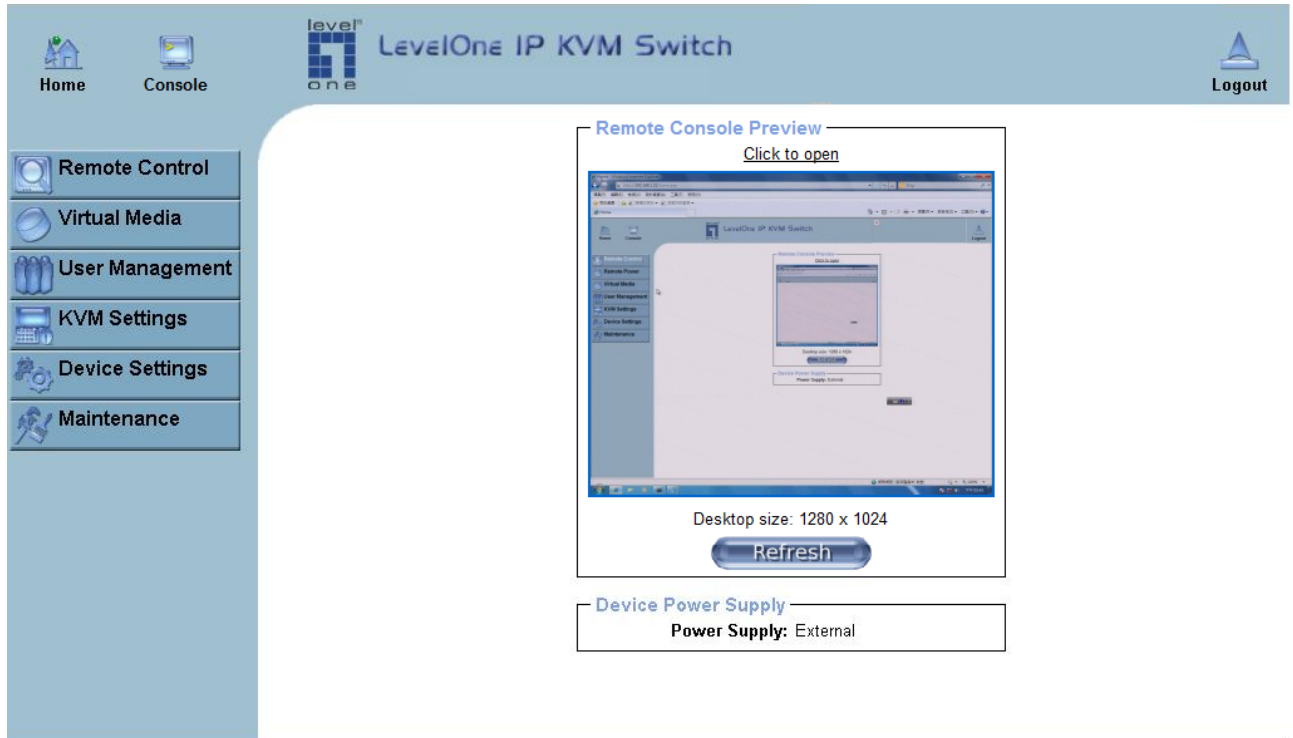

Figure 6-1. KVM Console

To open the KVM console, either click on the menu entry on the left, or on the console picture on the right. To refresh the picture, click on the button “Refresh”.

6.1.2 Telnet Console

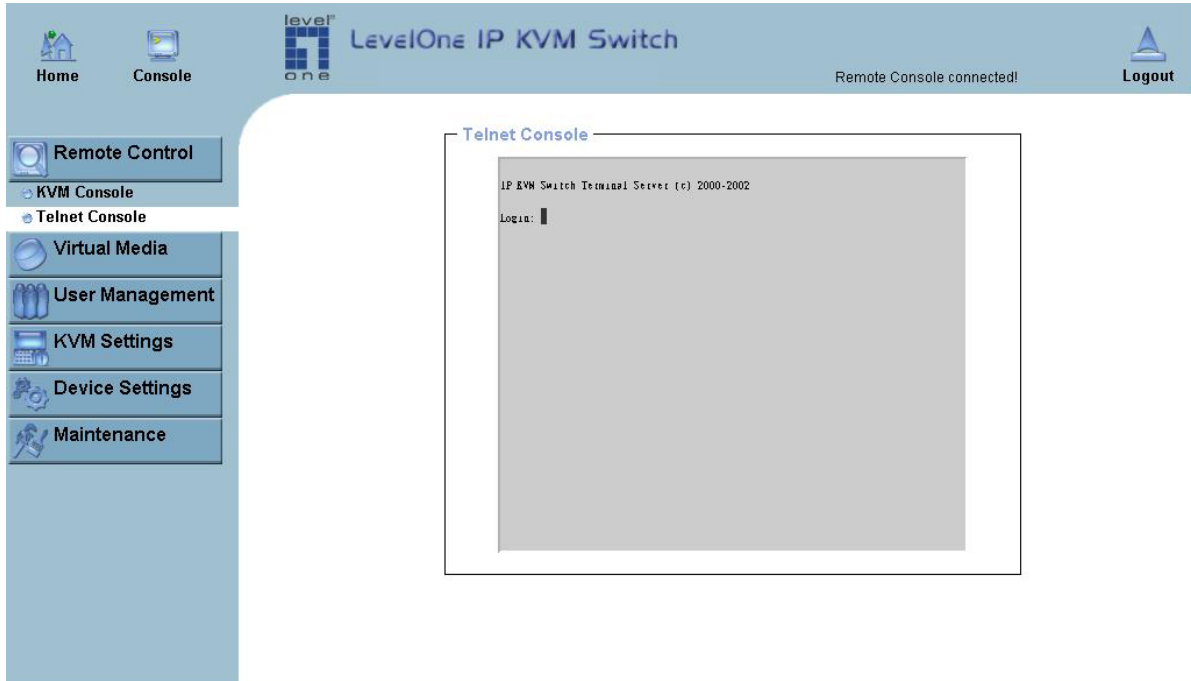

Figure 6-2. Telnet Console

The KVM IP Console Module firmware features a Telnet server that enables a user to connect via a standard Telnet client. In case the Telnet program is using a VT 100, VT 102 or VT 220 terminal or an according emulation, it is even possible to perform a console redirection as long as the KVM IP Console Module host machine is using a text mode screen resolution.

Connecting to the KVM IP Console Module is done as usual and as required by the Telnet client, for instance in a UNIX shell:

```
telnet 192.168.1.22
```

Replace the IP address by the one that is actually assigned to the KVM IP Console Module. This will prompt for username and password in order to log into the device. The credentials that need to be entered for authentication are identical to those of the web interface. That means, the user management of the Telnet interface is entirely controlled with the according functions of the web interface.

Once you have successfully logged into the KVM IP Console Module a command line will be presented and you can enter according management commands.

In general, the Telnet interface supports two operation modes: the command line mode and the terminal mode. The command line mode is used to control or display some parameters. In terminal mode the pass-through access to serial port 1 is activated (if the serial settings were configured accordingly). All inputs are redirected to the device on serial port 1 and its answers are displayed on the Telnet interface.

The following list shows the according command mode command syntax and their usage.

help

Displays the list of possible commands

cls

Clears the screen

quit

Exits the current session and disconnects from the client

version

Displays the release information

terminal

Starts the terminal passthrough mode for serial port 1. The key sequence *esc exit* switches back to the command mode.

6.2 Remote Power

Please refer to “Serial Power Controller - User Manual” for details.
The serial power equipment is option.

6.3 Virtual Media

6.3.1 Floppy Disk



Figure 6-6. Virtual Floppy Area

Upload a Floppy Image

A certain (floppy) image can be built up in two steps.

- Click “Browse” button and select the image file.

Figure 6-7. Select Image File

The maximum image size is limited to 1.44MB. For larger image please see section 6.3.2.

- Click “Upload” button to upload the chosen image file into the KVM IP Console Module’s onboard memory. This image file is kept in the onboard memory of the KVM IP Console Module until the end of the current session, as you logged out, or initiated a reboot of the KVM IP Console Module.

6.3.2 CD–ROM Image

Use Image on Windows Share (SAMBA)

To include an image from a Windows share, select “CD-ROM” from the submenu.

Figure 6-8. Selecting CD ROM

Active Image

No disk emulation set.

Image on Windows Share

Share host:

Share folder name:

Image file name:

User name:

Password:

Figure 6-9. Select Windows Share

The following information has to be given to mount the image properly:

Share host -- The server name or its IP address.

Share folder name -- The name of the share folder to be used.

Image file name -- The name of the image file on the share folder.

User name -- If necessary, specify the user name for the share named in advance. If unspecified, and a guest account is activated, this guest account information will be used as your login.

Password -- If necessary, specify the password for the given user name.

To register the specified file image and its location click on the button “Set”.

The specified image file is supposed to be accessible from the KVM IP Console Module. The information above has to be given from the point of view of the KVM IP Console Module. It is important to specify correct IP addresses, and device names. Otherwise, KVM IP Console Module may not be able to access the referenced image file.

Furthermore, the specified share has to be configured correctly. Therefore, administrative permissions are required. As a regular user you may not have these permissions. You should either login as a system administrator (or as “root” on UNIX systems), or ask your system administrator for help to complete this task.

Windows 2000/XP

Open the Explorer, navigate to the directory (or share), and press the right mouse button to open the context menu.

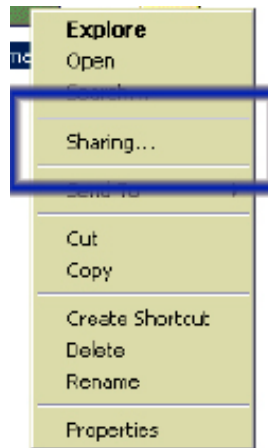

Figure 6-10. Explorer context menu

Select “Sharing” to open the configuration dialog.

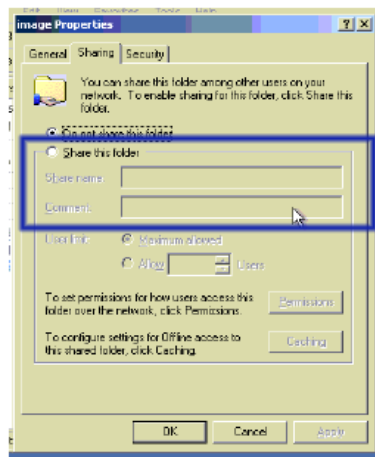

Figure 6-11. Share configuration dialog

Adjust the settings for the selected directory.

- Activate the selected directory as a share. Select “Sharing this folder”.
- Choose an appropriate name for the share. You may also add a short description for this folder (input field “Comment”).
- If necessary, adjust the permissions (button “permissions”).
- Click “OK” to set the options for this share.

UNIX and UNIX-like OS (Sun Solaris, and Linux)

If you like to access the share via SAMBA, SAMBA has to be set up properly. You may either edit the SAMBA configuration file `/etc/samba/smb.conf`, or use the Samba Web Administration Tool (SWAT) or WebMin to set the correct parameters.

Creating an Image

Floppy Images

UNIX and UNIX-like OS

To create an image file, make use of “dd”. This is one of the original UNIX utilities and is included in every UNIX-like OS (UNIX, Sun Solaris, and Linux).

To create a floppy image file, copy the contents of a floppy to a file. You can use the following command:

```
dd [ if=/dev/fd0 ] [ of=/tmp/floppy.image ]
```

dd reads the entire disc from the device /dev/fd0, and saves the output in the specified output file /tmp/floppy.image. Adjust both parameters exactly to your needs (input device etc.)

MS Windows

You can use the tool “Raw Write for Windows”. It is included on the CD ROM shipped with KVM IP Console Module.

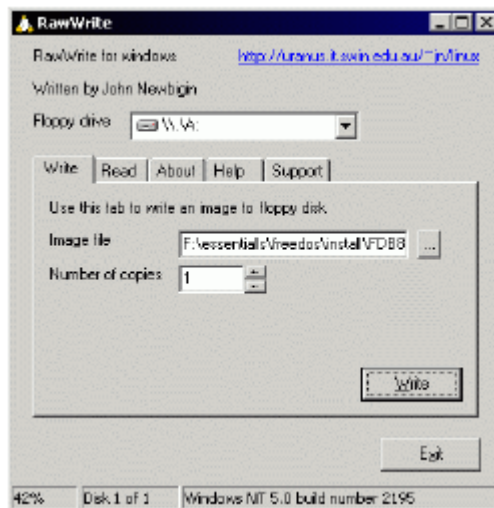

Figure 6-12. RawWrite for Windows selection dialog

From the menu, select the tab “Read”. Enter (or choose) the name of the file in which you would like to save the floppy content. Click on the button “Copy” to initiate the image creation process.

For related tools you may have a look at www.fdos.org

CD ROM/ISO Images

UNIX and UNIX-like OS

To create an image file, make use of “dd”. This is one of the original UNIX utilities and is included in every UNIX-like OS (UNIX, Sun Solaris, and Linux).

To create a CDROM image file, copy the contents of the CDROM to a file. You can use the following command:

```
dd [ if=/dev/cdrom ] [ of=/tmp/cdrom.image ]
```

dd reads the entire disc from the device /dev/cdrom, and saves the output in the specified output file /tmp/cdrom.image. Adjust both parameters exactly to your needs (input device etc.).

MS Windows

To create the image file, use your favorite CD imaging tool. Copy the whole contents of the disc into one single image file on your hard disk.

For example, with “Nero” you choose “Copy and Backup”. Then, navigate to the “Copy Disc” section. Select the CD ROM or DVD drive you would like to create an image from. Specify the filename of the image, and save the CD ROM content in that file.



Figure 6-13. Nero selection dialog

6.3.3 Drive redirection

The Drive Redirection is another possibility to use a virtual disc drive on the remote computer. With Drive Redirection you do not have to use an image file but may work with a drive from your local computer on the remote machine. The drive is hereby shared over a TCP network connection. Devices such as floppy drives, hard discs, CD ROMs and other removable devices like USB sticks can be redirected. It is even possible to enable a write support so that for the remote machine it is possible to write data to your local disc.

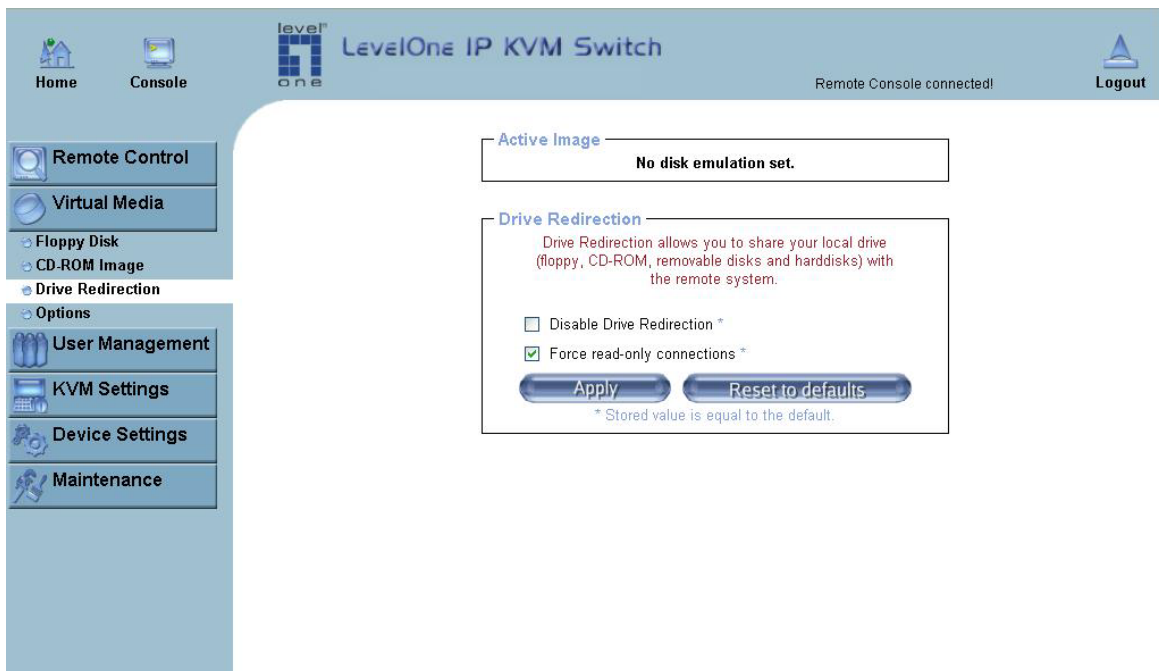

Figure 6-14. Options of Drive Redirection

Please note that Drive Redirection works on a level which is far below the operating system. That means that neither the local nor the remote operating system is aware that the drive is currently redirected, actually. This may lead to inconsistent data as soon as one of the operating systems (either from the local machine, or from the remote host) is writing data on the device. If write support is enabled the remote computer might damage the data and the file system on the redirected device. On the other hand, if the local operating system writes data to the redirected device the drive cache of the operating system of the remote host might contain older data. This may confuse the remote host's operating system. We recommend to use the Drive Redirection with care, especially the write support.

Active Image

No disk emulation set.

Drive Redirection

Drive Redirection allows you to share your local drive (floppy, CD-ROM, removable disks and harddisks) with the remote system.

To use this feature, you need the Drive Redirection Tool or the KVM Vision Viewer on your client machine. Please ask the vendor of IP KVM how to get the tools.

Disable Drive Redirection

Force read-only connections

Apply

Disable Drive Redirection

If enabled the Drive Redirection is switched off.

Force read-only connections

If enabled the Write Support for the Drive Redirection is switched off. It is not possible to write on a redirected device.

Click **Apply** to submit your changes.

There are two methods of Drive Redirections:

1. External Drive Redirection Utility
2. Built-in Java Drive Redirection function in Remote Console

6.3.3.1 Driver Redirection Utility Installation

Please follow the Drive Redirection Setup Wizard step by step to install the driver from the attached CD ROM.

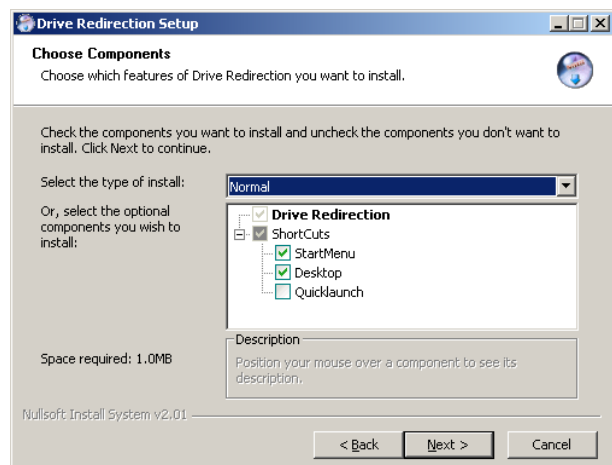

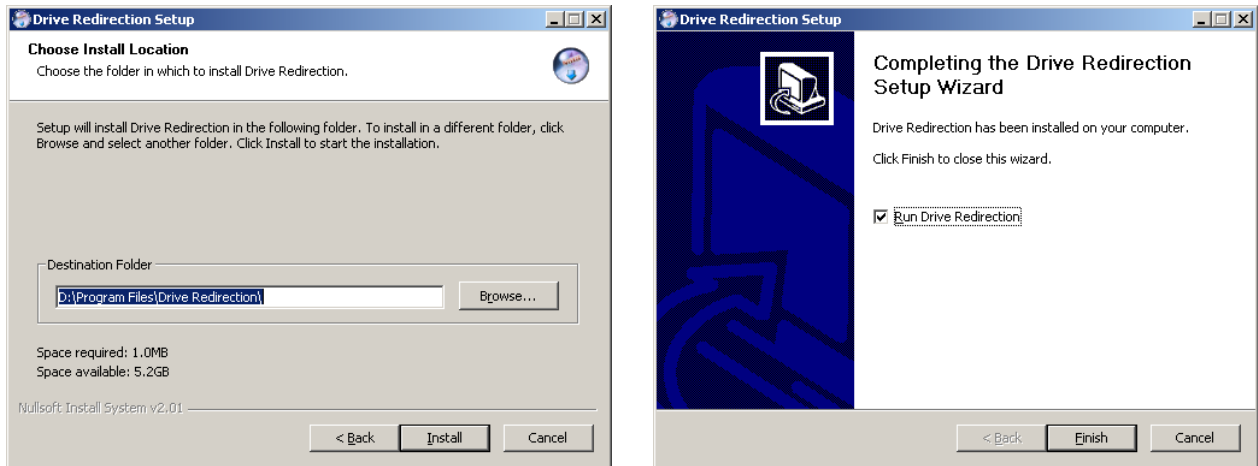

Figure 6-15. Drive Redirection Setup

Drive Redirection Settings

- Start Drive Redirection

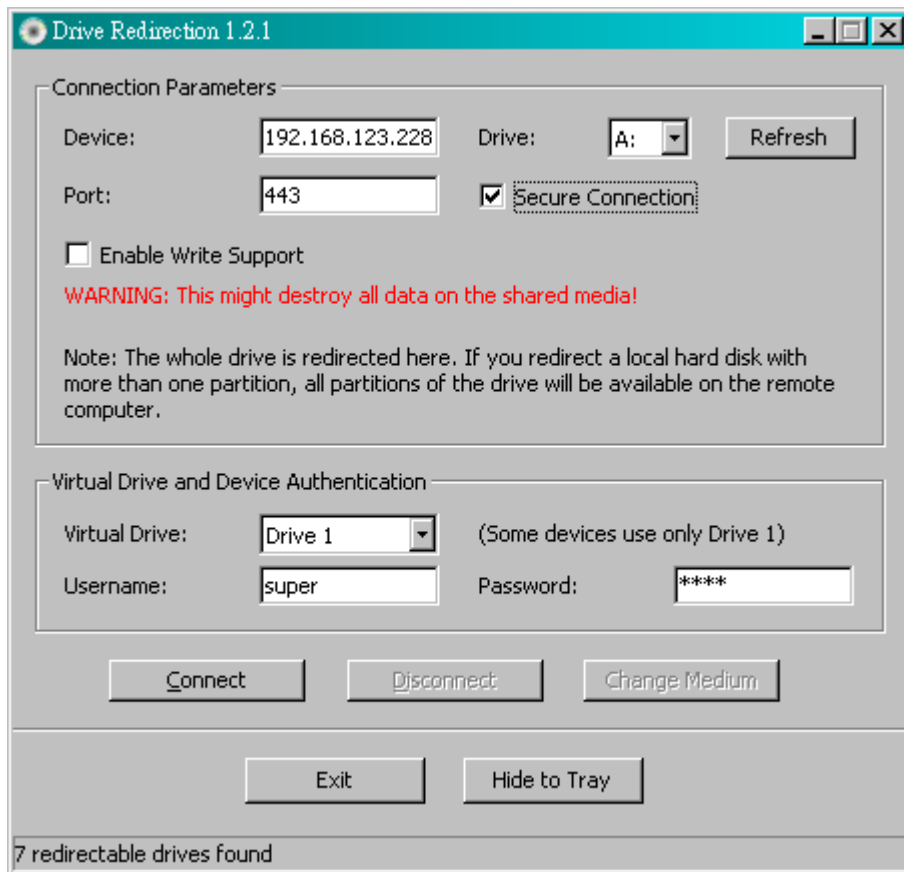

Figure 6-16. Drive Redirection dialog

Drive to redirect

Device

This is the address (either the DNS name or the IP address) of the KVM IP Console Module you would like to connect to.

Drive

The local drive you want to share with the remote computer, which could be Floppy disc, CD-ROMs, USB-Sticks and hard drives.

Port

This is the network port. By default, KVM IP Console Module uses the remote console port (#443) here. You may change this value if you have changed the remote console port in your KVM IP Console Module's network settings.

Secure Connection

Enable this box to establish a secure connection via SSL. This will maximize the security but may reduce the connection speed.

Select the drive you would like to redirect. All available devices (drive letters) are shown here. Please note that the whole drive is shared with the remote computer, not only one partition. If you have a hard disc with more than one partition all drive letters that belong to this disc will be redirected. The Refresh button may be used to regenerate the list of drive letters, especially for an USB stick.

Warning

Please be cautious that if "Allow Write Support" is selected, all data on the shred media might be destroyed.

Write Support

This feature may be enabled here. Write support means that the remote computer is allowed to write on your local drive. As you can imagine, this is very dangerous. If both the remote and the local system try to write data on the same device, this will certainly destroy the file system on the drive. Please use this only when you exactly know what you are doing.

Device Authentication

The factory default Username is "super" and the default Password is "pass".

- Click **Connect** to redirect drive

Warning

1. Drive Redirection is only possible with Windows 2000 and above versions.
2. The Drive Redirection works on a low SCSI level and the SCSI protocol cannot recognize partitions; therefore the whole drive selected will be shared instead of any particular partition.
3. While connecting to a legacy KVM switch, please select PS/2 mouse for **Keyboard/Mouse setting** from webpage. Otherwise you will not be able to use Hot-key.

Navigation Buttons

Connect/Disconnect

To establish the drive redirection please press the **Connect** button once. If all the settings are correct, the status bar displays that the connection has been established, the Connect button is disabled and the Disconnect button is enabled.

On an error, the status line shows the error message. The drive redirection software tries to lock the local drive before it is redirected. That means that it tries to prevent the local operating system from accessing the drive as long as it is redirected. This may also fail, especially if a file on the drive is currently open. In the case of a locking failure, you will be prompted if you want to establish the connection anyhow. This should not be a serious problem when the note above is respected. If the write support is enabled, a drive which is not locked might be damaged by the Drive Redirection.

With the **Disconnect** button, a connection via Drive Redirection connection is stopped.

Exit/Hide

If the **Exit** button is pressed, the Drive Redirection software is closed. If a Drive Redirection connection is active, the connection will be closed before the application terminates.

Using the Hide to Tray button the application is hidden, but not terminated completely. That means that an active connection will be kept active until it is closed explicitly. You can access the software by its tray icon. The tray icon also shows whether a connection is established or not. A double click on the icon shows the application window, or with a right click you may access a small menu



6.3.3.2 Built-in Java Drive Redirection

1. Run Remote Control > KVM Console.
2. Click “Floppy” icon 

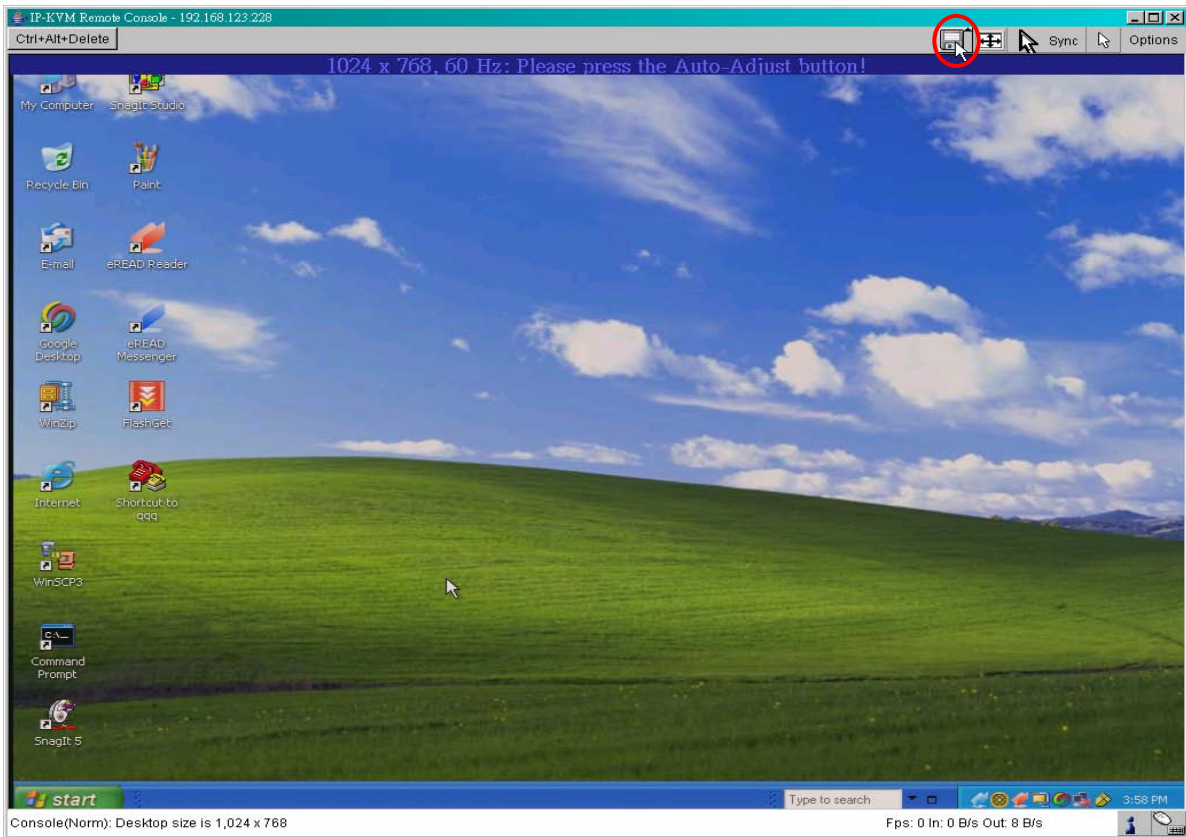

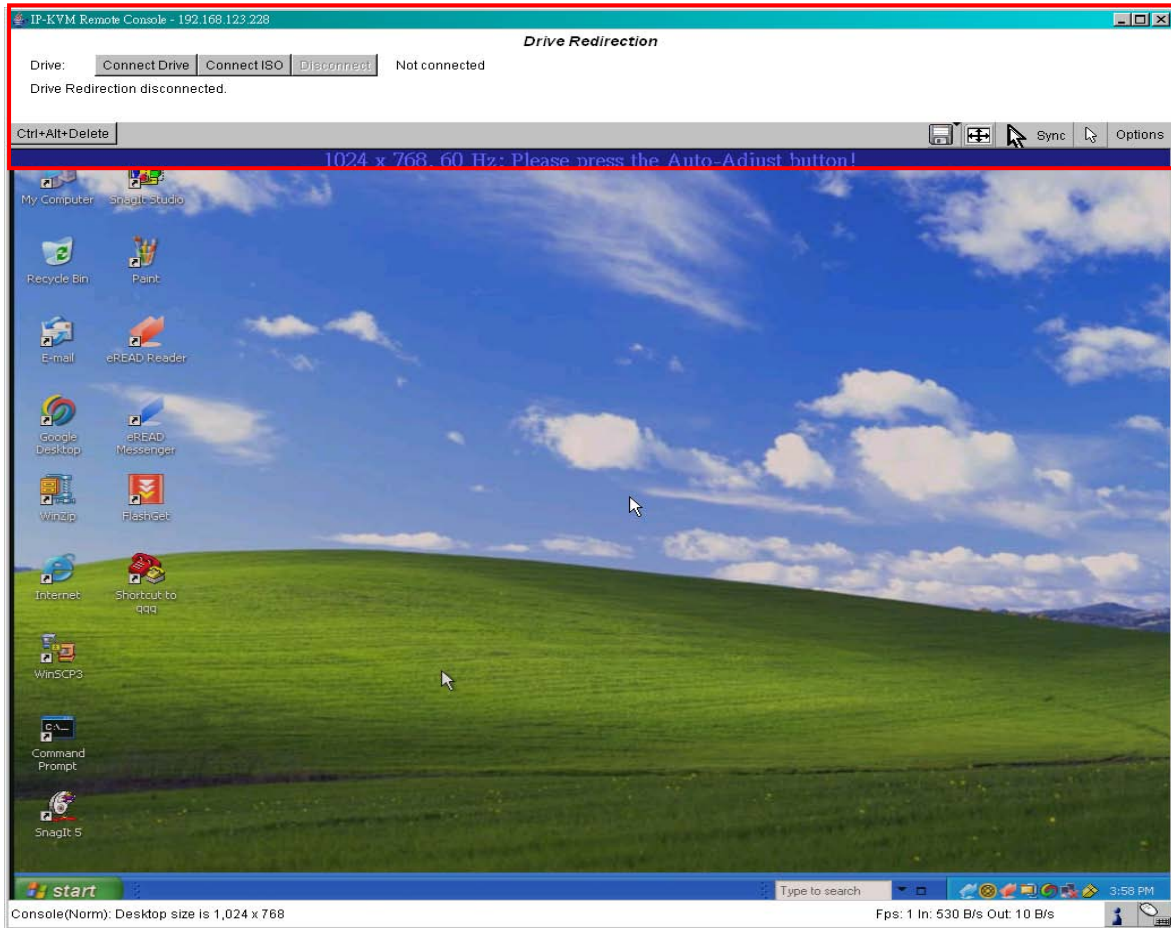

3. Click **Connect Drive** or **Connect ISO**



4. Select a drive to redirect (if Connect Drive)

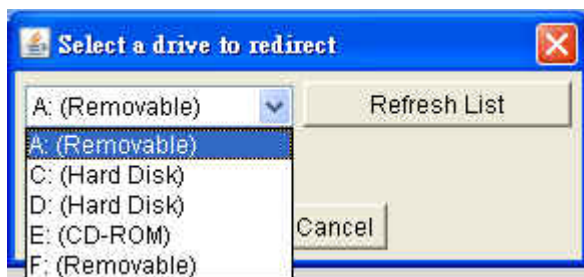

5. Select a ISO image to redirect (if Connect ISO)

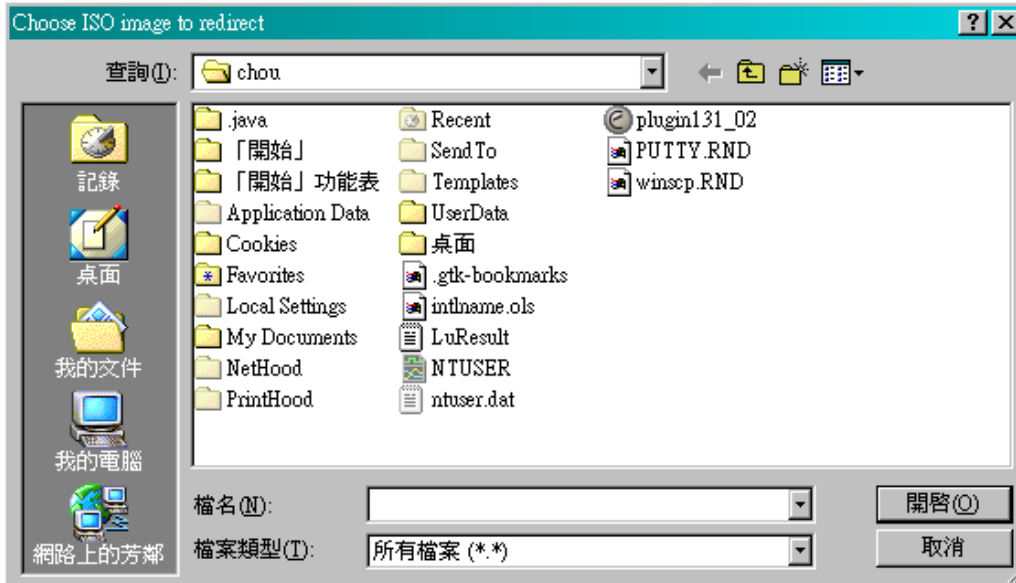

6.3.4 Options

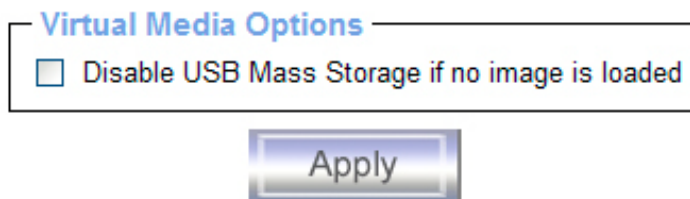

Figure 6-17. USB mass storage option

Set this option to disable the mass storage emulation (and hide the virtual drive) if no image file is currently loaded. If unset, and no file image will be found it may happen that the host system will hang on boot due to changes in the boot order, or the boot manager (LILO, GRUB). This case was reported for some Windows versions (2000, XP), other OS might not be fully excluded. This behavior depends on the BIOS version used in that machine.

To set this option, press the button “Apply”.

6.4 User Management

6.4.1 Change Password

The screenshot shows the LevelOne IP KVM Switch web interface. The top navigation bar includes 'Home', 'Console', the LevelOne logo, 'LevelOne IP KVM Switch', 'Remote Console connected!', and 'Logout'. The left sidebar contains a menu with 'Remote Control', 'Virtual Media', 'User Management', 'Change Password' (selected), 'Users', 'KVM Settings', 'Device Settings', and 'Maintenance'. The main content area displays the 'Change Password' form with three input fields: 'Old Password', 'New Password', and 'Confirm New Password', followed by an 'Apply' button.

Figure 6-18. Set password

To change your password, enter the new password in the upper entry field. Retype the password in the field below. Click “Apply” to submit your changes.

6.4.2 Users and Groups

The screenshot shows the LevelOne IP KVM Switch web interface. The top navigation bar includes 'Home', 'Console', the LevelOne logo, 'LevelOne IP KVM Switch', 'Remote Console connected!', and 'Logout'. The left sidebar contains a menu with 'Remote Control', 'Virtual Media', 'User Management', 'Change Password', 'Users' (selected), 'KVM Settings', 'Device Settings', and 'Maintenance'. The main content area displays the 'User Management' form with the following fields: 'Existing users' (dropdown menu), 'Lookup' button, 'New user name', 'Full user name', 'Password', 'Confirm Password', 'Email address', 'Mobile number', 'Role' (dropdown menu set to 'Administrator'), and an unchecked checkbox 'Enforce user to change password on next login *'. At the bottom of the form are three buttons: 'Create', 'Modify', and 'Delete'.

Figure 6-19. Set User

The KVM IP Console Module comes with 1 pre-configured user account that has fixed permissions. The account “super” has all possible rights to configure the device and to use all functions KVM IP Console Module offers.

Upon delivery, the account “super” has the password “pass”. Make sure to change password immediately after you have installed and on initial access of your KVM IP Console Module.

Existing users

Select an existing user for modification. Once a user has been selected, click the lookup button to see the user information.

New User name

The new user name for the selected account.

Password

The password for the login name. It must be at least three characters long.

Confirm password

Confirmation of the password above.

Email address

This is optional.

Mobile number

This information may be optionally provided.

Role

Each user can be a member of a group (named a “role”) - either an administrator, or an regular user. Choose the desired role from the selection box.

To create an user press the button “Create”. The button “Modify” changes the displayed user settings. To delete an user press the button “Delete”.

Note:The KVM IP Console Module is equipped with an host-independent processor and memory unit which both have a limitation in terms of the processing instructions and memory space. To guarantee an acceptable response time we recommend not to exceed the number of 15 users connected to the KVM IP Console Module at the same time. The memory space that is available onto the KVM IP Console Module mainly depends on the configuration and the usage of the KVM IP Console Module (log file entries etc.). That’s why we recommend not to store more than 150 user profiles.

6.5 KVM Settings

6.5.1 User Console

The following settings are user specific. That means, the super user can customize these settings for every users separately. Changing the settings for one user does not affect the settings for the other users.

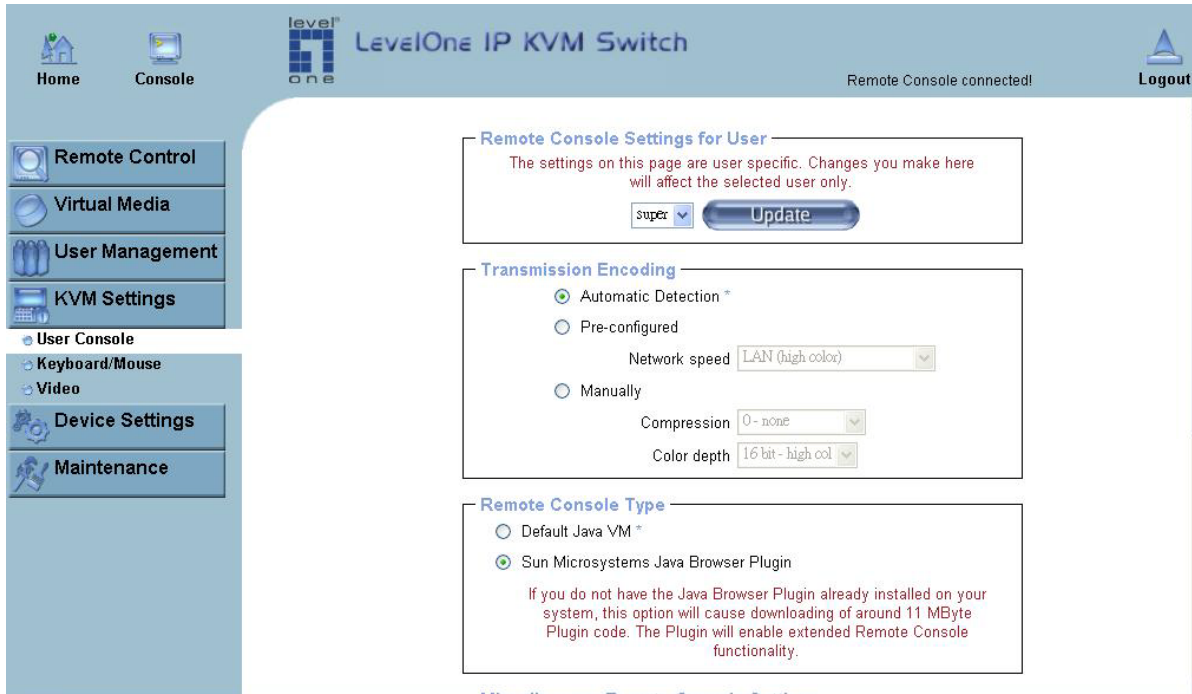

Figure 6-20. User Console Settings (Part 1)

User select box

This selection box displays the user ID for which the values are shown and for which the changes will take effect. You may change the settings of other users if you have the required privileges.

Transmission Encoding

The Transmission Encoding setting allows changing the image-encoding algorithm that is used to transmit the video data to the Remote Console window. It is possible to optimize the speed of the remote screen processing depending on the number of users working at the same time and the network bandwidth of the connection line (Modem, ISDN, DSL, LAN, etc.).

Automatic detection

The encoding and the compression level is determined automatically from the available bandwidth and the current content of the video image.

Pre-configured

The pre-configured settings deliver the best result because of optimized adjustment of compression and colour depth for the indicated network speed.

Manually

Allows to adjust both compression rate and the colour depth individually. Depending on the selected compression rate the data stream between the

KVM IP Console Module and the Remote Console will be compressed in order to save bandwidth. Since high compression rates consume more computing power of KVM IP Console Module, they should not be used while several users are accessing the KVM IP Console Module simultaneously.

The standard color depth is 16 Bit (65536 colors). The other color depths are intended for slower network connections in order to allow a faster transmission of data. Therefore compression level 0 (no compression) uses only 16 Bit color depth. At lower bandwidths only 4 Bit (16 colors) and 2 Bit (4 gray scales) are recommended for typical desktop interfaces. Photo-like pictures have best results with 4 Bit (16 gray scales). 1 Bit color depth (black/white) should only be used for extremely slow network connections.

Miscellaneous Remote Console Settings

Start in Monitor Mode *

Start in Exclusive Access Mode *

Mouse Hotkey

Hotkey (Help)

Used for fast mouse synchronization (in Double Mouse mode) and to free the grabbed mouse (in Single Mouse mode).

Remote Console Button Keys

Button Key	Key Definition (Help)	Name
Button Key 1	<input type="text" value="confirm Ctrl+Alt+Delete"/>	<input type="text"/>

* Closed values is equal to the default

Figure 6-21. User Console Settings (Part 2)

Remote Console Type

Specifies, which Remote Console Viewer to use.

Default Java-VM

Uses the default Java Virtual Machine of your Browser. This may be the Microsoft JVM for the Internet Explorer, or the Sun JVM if it is configured this way. Use of the Sun JVM may also be forced (see below).

Sun Microsystems Java Browser Plugin

Instructs the web browser of your administration system to use the JVM of Sun Microsystems. The JVM in the browser is used to run the code for the Remote Console window, which is actually a Java Applet. If you check this box for the first time on your administration system and the appropriate Java plug-in is not already installed on your system, it will be downloaded and installed automatically. However, in order to make the installation possible, you still need to answer the according dialogs with “yes” . The download volume is around 11 Mbytes. The advantage of downloading Sun's JVM lays in providing

a stable and identical Java Virtual Machine across different platforms. The Remote Console software is optimized for this JVM versions and offers wider range of functionality when run in SUN's JVM. Please make sure that you are installing Sun JVM 1.4.2 or above to your client system.

Miscellaneous Remote Console Settings

Start in Monitor Mode

Sets the initial value for the monitor mode. By default the monitor mode is off. In case you switch it on, the Remote Console window will be started in a read only mode.

Start in Exclusive Access Mode

Enables the exclusive access mode immediately at Remote Console startup. This forces the Remote Consoles of all other users to close. No one can open the Remote Console at the same time again until this user disables the exclusive access or logs off.

Mouse hotkey

Allows to specify a hotkey combination which starts either the mouse synchronization process if pressed in the Remote Console, or is used to leave the single mouse mode.

Remote Console Button Keys

Button Keys allow simulating keystrokes on the remote system that cannot be generated locally. The reason for this might be a missing key or the fact, that the local operating system of the Remote Console is unconditionally catching this keystroke already. Typical examples are "Control+Alt+Delete" on Windows and DOS, what is always caught, or "Control+Backspace" on Unix or Unix-like OS for terminating the X-Server. The syntax to define a new Button Key is as follows:

[confirm] <keycode>[+|-[*]<keycode>]*

"confirm" requests confirmation by a dialog box before the key strokes will be sent to the remote host.

"keycode" is the key to be sent. Multiple key codes can be concatenated with a plus, or a minus sign. The plus sign builds key combinations, all keys will be pressed until a minus sign or the end of the combination is encountered. In this case all pressed keys should be released in reversed sequence. The minus sign builds single, separate key presses and releases. The star inserts a pause with duration of 100 milliseconds.

6.5.2 Keyboard/Mouse

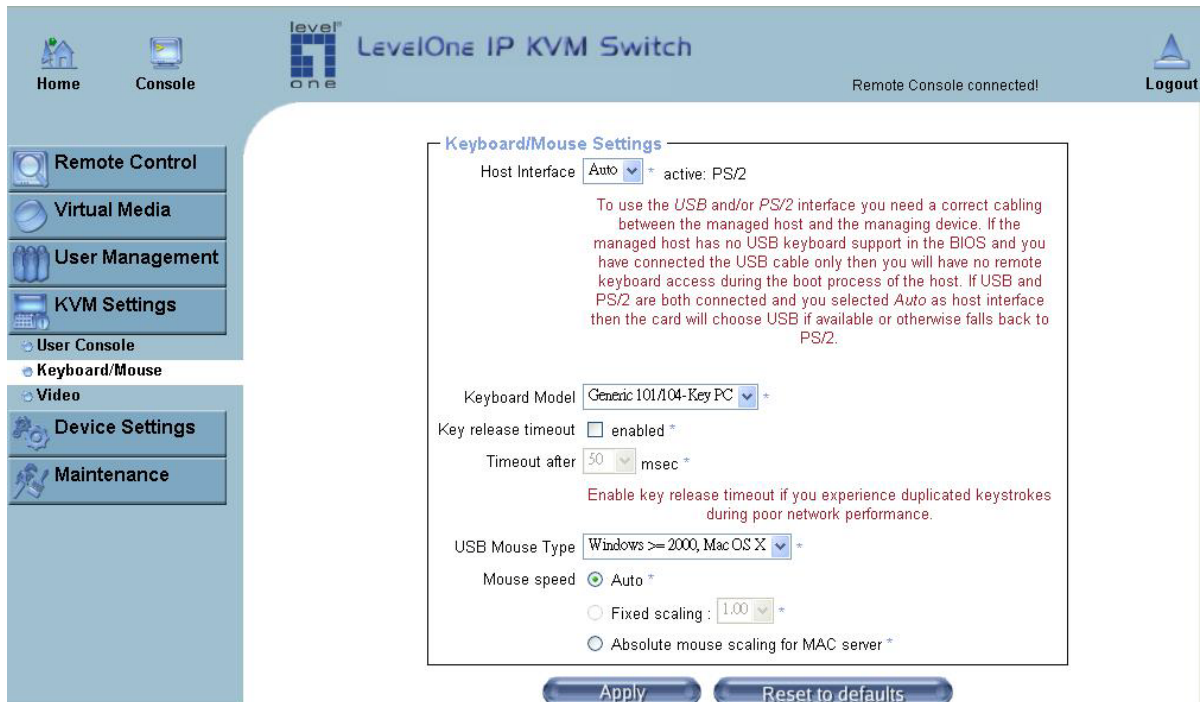

Figure 6-22. Keyboard and Mouse Settings

Host Interface

Enables a certain interface the mouse is connected to. You can choose between “Auto” for automatic detection, “USB” for an USB mouse, and “PS/2” for a PS/2 mouse.

Warning

To use the USB and/or PS/2 interface you need a correct cabling between the managed host and the managing device. If the managed host has no USB keyboard support in the BIOS and you have connected the USB cable only then you will have no remote keyboard access during the boot process of the host. If USB and PS/2 are both connected and you selected “Auto” as host interface, then the card will select “USB” if available or otherwise falls back to “PS/2”.

To get USB remote keyboard access during the boot process of the host, the following conditions must be fulfilled:

- the host BIOS must have USB keyboard support
- the USB cable must be connected or must be selected in the Host interface option

PS/2 Keyboard Model

Enables a certain keyboard layout. You can choose between “Generic 101-Key PC” for a standard keyboard layout, “Generic 104-Key PC” for a standard keyboard

layout extended by three additional windows keys, “Generic 106-Key PC” for a Japanese keyboard, and “Apple Macintosh” for the Apple Macintosh.

Keyboard timeout

Recommended as “enable” for keyboard timeout when host is UNIX or UNIX-like OS.

USB Mouse Type

Enables USB mouse type. Choose between “Windows >= 2000 , MacOSX” for MS Windows 2000 or Windows XP, Mac OSX or “Other Operating Systems” for MS Windows NT, Unix or Unix-like OS, or OS X. In “Windows >= 2000 , MacOSX” mode the remote mouse is always synchronized with the local mouse.

Mouse Speed

- Auto mouse speed

Use this option if the mouse settings on host use an additional acceleration setting. The KVM IP Console Module tries to detect the acceleration and speed of the mouse during the mouse sync process.

- Fixed mouse speed

Use a direct translation of mouse movements between the local and the remote pointer.

You may also set a fixed scaling which determines the pixel-amount of the remote mouse pointer movement when the local mouse pointer is moved by one pixel. This option is used to manually control the remote mouse speed and only works when the mouse settings on the host are linear. This means mouse acceleration of OS should be disabled, and the intelligent mouse synchronization of KVM IP Console Module is not functioning under this setting.

- Absolute mouse scaling for MAC server

Use this option for MAC server.

To set the options, click on the button “Apply”.

6.5.3 Video

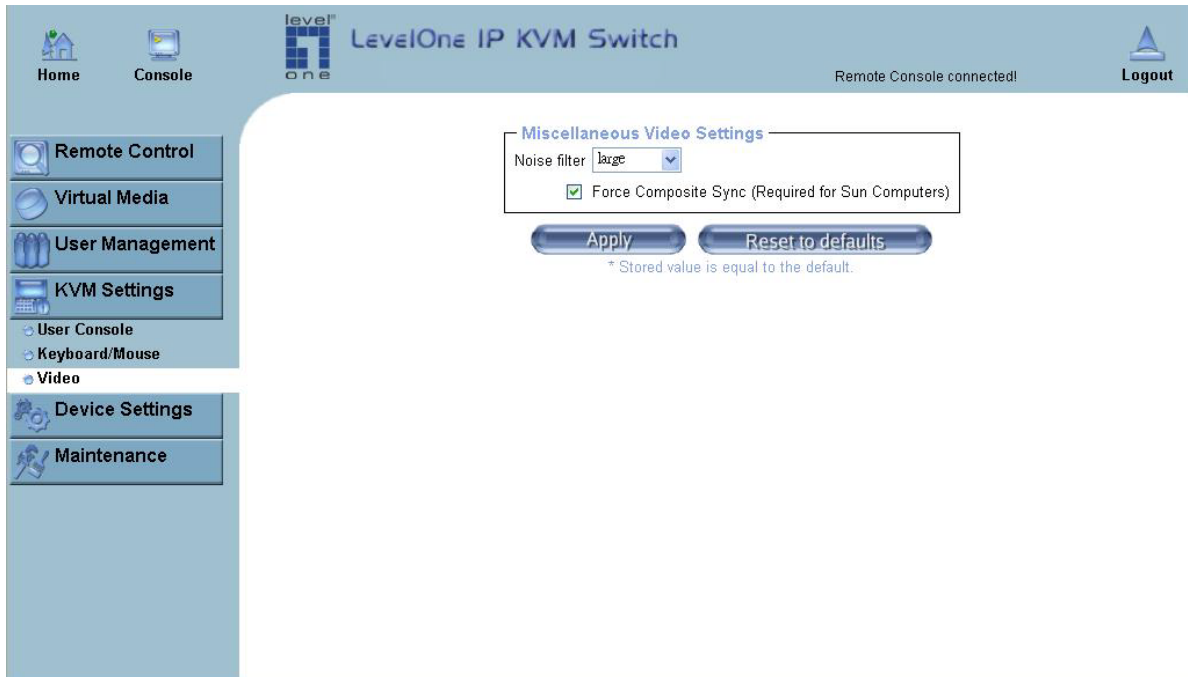

Figure 6-23. Video Settings

Miscellaneous Video Settings

- Noise filter

This option defines how the KVM IP Console Module reacts to small changes in the video input signal. Turning on the noise filter can help reduce video flickering that is often caused by distortions, as well as lowering unnecessary bandwidth consumption. A large filter setting needs less network traffic and leads to a faster video display, but small changes in some display regions may not be recognized immediately. A small filter displays all changes instantly but may lead to a constant amount of network traffic even if the display content is not really changing (depending on the quality of the video input signal). All in all the default setting should be suitable for most situations.

- Force Composite Sync (Required for Sun Computers)

When connecting the device directly to legacy Sun computer (with composite sync as the video output, it may be possible that KVM IP Console Module don't recognize the composite sync automatically. To support signal transmission from a Sun machine, enable this option. If not enabled the picture of the remote console will not be visible.

To set the options, click on the button "Apply".

6.6 Device Settings

6.6.1 Network

The Network Settings panel as shown in Figure 6-24 allows changing network related parameters. Each parameter will be explained below. Once applied the new network settings will immediately come into effect.

The screenshot displays the 'LevelOne IP KVM Switch' web interface. The top navigation bar includes 'Home', 'Console', the 'level one' logo, the title 'LevelOne IP KVM Switch', and a 'Remote Console connected!' status indicator. A sidebar on the left contains menu items: 'Remote Control', 'Virtual Media', 'User Management', 'KVM Settings', 'Device Settings', 'Network', 'Dynamic DNS', 'Security', 'Certificate', 'Serial Port', 'Date/Time', 'Event Log', and 'Maintenance'. The 'Device Settings' section is expanded to show 'Network Settings'. This section is divided into three panels:

- Network Basic Settings:**
 - IP auto configuration: DHCP
 - Preferred host name (DHCP only): *
 - IP address: 192.168.50.139
 - Subnet mask: 255.255.255.0 *
 - Gateway IP address: 192.168.50.1
 - Primary DNS server IP address: 168.95.192.1
 - Secondary DNS server IP address: 168.95.1.1
- Network Miscellaneous Settings:**
 - Remote Console & HTTPS port: 443 *
 - HTTP port: 80 *
 - TELNET port: 23 *
 - SSH port: 22 *
 - Bandwidth Limit: kbit/s *
 - Enable TELNET access
 - Enable SSH access *
 - Disable Setup Protocol *
- LAN Interface Settings:**
 - Current LAN interface parameters: autonegotiation on, 100 Mbps, full duplex, link ok
 - LAN interface speed: Autodetect *
 - LAN interface duplex mode: Autodetect *

At the bottom of the settings area are 'Apply' and 'Reset to defaults' buttons. A note below the buttons states: '* Stored value is equal to the default.'

Figure 6-24. Network Settings

Warning

The initial IP configuration is usually done directly at the host system using the special procedure described in Table 4-1.

Warning

Changing the network settings of the KVM IP Console Module might result in losing connection to it. In case you change the settings remotely make sure that all the values are correct and you still have an option to access the KVM IP Console Module.

IP auto configuration

With this option you can control if the KVM IP Console Module should fetch its network settings from a DHCP or BOOTP server. For DHCP, select “dhcp” , and for BOOTP select “bootp” accordingly. If you choose “none” then IP auto configuration is disabled.

Preferred host name

Preferred host name to request from DHCP server. Whether the DHCP server takes the KVM IP Console Module suggestion into account or not depends on the server configuration.

IP address

IP address in the usual dot notation.

Subnet Mask

The net mask of the local network.

Gateway IP address

In case the KVM IP Console Module should be accessible from networks other than the local one, this IP address must be set to the local network router's IP address.

Primary DNS Server IP Address

IP address of the primary Domain Name Server in dot notation. This option may be left empty, however the KVM IP Console Module will not be able to perform name resolution.

Secondary DNS Server IP Address

IP address of the secondary Domain Name Server in dot notation. It will be used in case the Primary DNS Server cannot be contacted.

Remote Console And HTTPS port

Port number at which the KVM IP Console Module 's Remote Console server and HTTPS server are listening. If left empty the default value will be used.

HTTP port

Port number at which the KVM IP Console Module 's HTTP server is listening. If left empty the default value will be used.

Telnet port

Port number at which the KVM IP Console Module 's Telnet server is listening. If left empty the default value will be used.

SSH port

Port number at which the KVM IP Console Module SSH (Secure SHell) server is listening. If left empty the default value (port 22) will be used.

Bandwidth limitation

The maximum network traffic generated through the KVM IP Console Module ethernet device. Value in Kbit/s.

Enable Telnet access

This enables the Telnet function.

Enable SSH access

This enables the SSH (Secure SHell) function.

Disable Setup Protocol

Enable this option to exclude the KVM IP Console Module from the setup protocol. Setup protocol is a proprietary layer-2 MAC-based protocol to allow some configuration software to detect KVM IP Console Module devices in the network, even without IP address, and then config network related settings to KVM IP Console Module..

LAN Interface Settings

The “Autodetect” will set the ethernet speed to the fastest possible value supported by both endpoints of the link. For example, if you use a 10M/half duplex HUB, this speed will be auto-selected. If this option does not work with some network device (HUB, switches, and routers), you can set the Ethernet interface speed of KVM IP Console Module manually to the values as supported by the network device.

6.6.2 Dynamic DNS

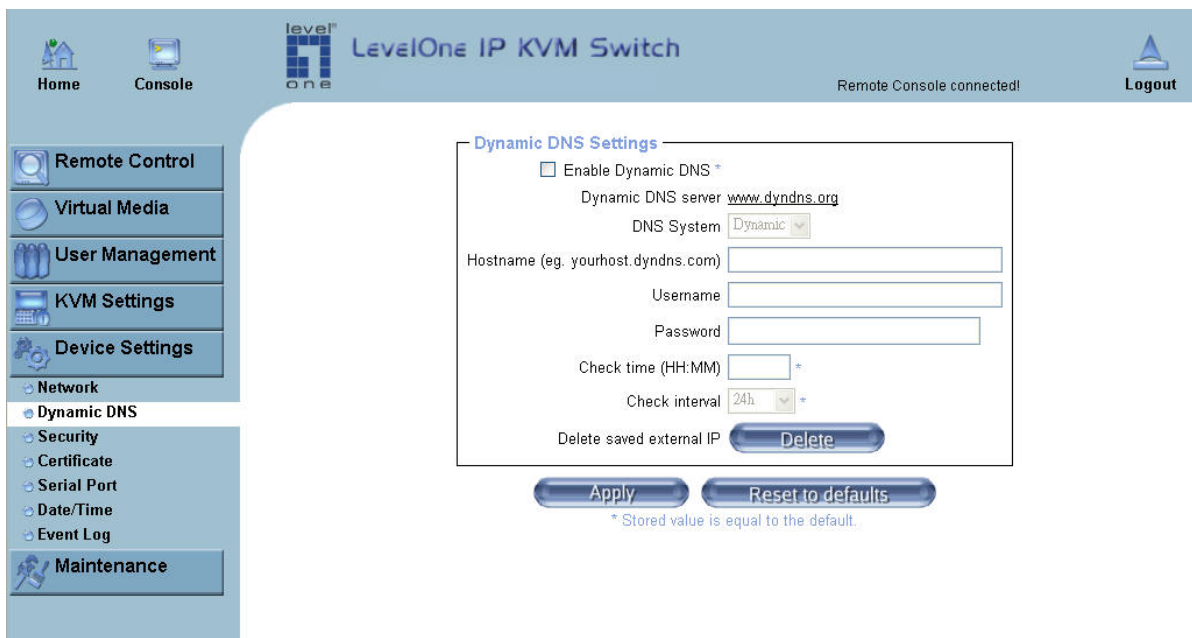

The screenshot shows the web interface for a LevelOne IP KVM Switch. The top navigation bar includes 'Home', 'Console', the 'LevelOne IP KVM Switch' logo, 'Remote Console connected!', and 'Logout'. A left-hand navigation menu lists various system functions. The main content area is titled 'Dynamic DNS Settings' and contains the following configuration options:

- Enable Dynamic DNS *
- Dynamic DNS server: www.dyndns.org
- DNS System: Dynamic (dropdown menu)
- Hostname (eg. yourhost.dyndns.com): [text input field]
- Username: [text input field]
- Password: [text input field]
- Check time (HH:MM): [text input field] *
- Check interval: 24h (dropdown menu) *
- Delete saved external IP: [Delete button]
- [Apply button] [Reset to defaults button]

* Stored value is equal to the default.

Figure 6-25. Dynamic DNS

A freely available Dynamic DNS service (www.dyndns.org) can be used in the following scenario (see Figure 6-26):

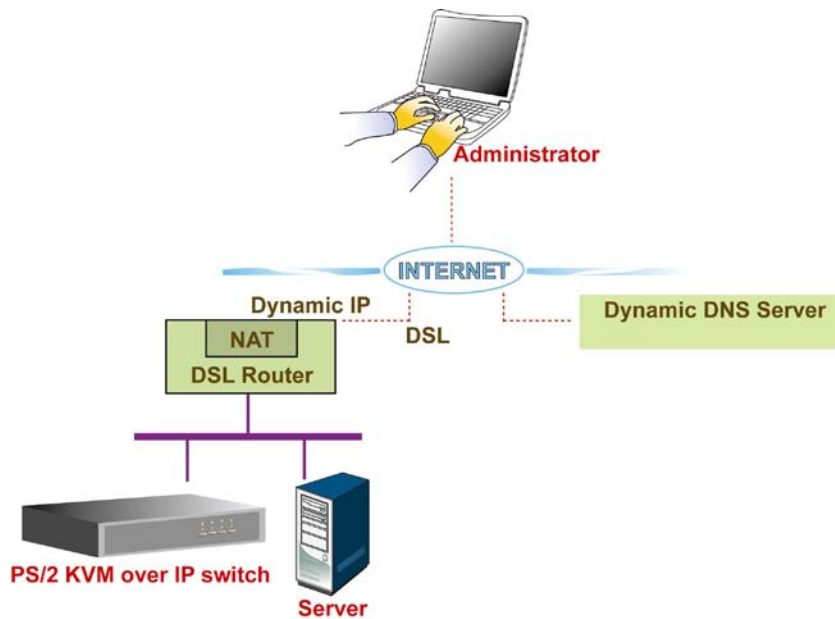

Figure 6-26. Dynamic DNS Scenario

The KVM IP Console Module is reachable via the IP address of the DSL router, which is dynamically assigned by the provider. Since the administrator does not know the IP address assigned by the provider, the KVM IP Console Module connects to a special dynamic DNS server in regular intervals and registers its IP address there. The administrator may contact this server as well and pick up the same IP address belonging to his card.

The administrator has to register an KVM IP Console Module that is supposed to take part in the service with the Dynamic DNS Server and assign a certain hostname to it. He will get a nickname and a password in return to the registration process. This account information together with the hostname is needed in order to determine the IP address of the registered KVM IP Console Module.

You have to perform the following steps in order to enable Dynamic DNS:

- Make sure that the LAN interface of the KVM IP Console Module is properly configured.
- Enter the Dynamic DNS Settings configuration dialog as shown in Figure 6-25.
- Enable Dynamic DNS and change the settings according to your needs (see below).

Enable Dynamic DNS

This enables the Dynamic DNS service. This requires a configured DNS server IP address.

Dynamic DNS server

This is the server name where KVM IP Console Module registers itself in regular intervals. Currently, this is a fixed setting since only dyndns.org is supported for now.

DNS System

Choose Dynamic for free DNS service. Custom for your own domain.

Hostname

This is the hostname of the KVM IP Console Module that is provided by the Dynamic DNS Server. (use the whole name including the domain, e.g. testserver.dyndns.org , not just the actual hostname).

Username

You have registered this username during your manual registration with the Dynamic DNS Server. Spaces are not allowed in the Nickname.

Password

You have used this password during your manual registration with the Dynamic DNS Server.

Check time

The KVM IP Console Module registers itself for initiating the IP address of KVM IP Console Module stored in the Dynamic DNS server at this time.

Check interval

This is the interval for reporting again to the Dynamic DNS server for updating the IP address associated with the Domain Name of the KVM IP Console Module.

Warning

The KVM IP Console Module has its own independent real time clock. Make sure the time setting of the KVM IP Console Module is correct. (see the Section called *Date And Time*)

6.6.3 Security

The screenshot displays the 'LevelOne IP KVM Switch' web interface. The top navigation bar includes 'Home', 'Console', 'LevelOne IP KVM Switch', 'Remote Console connected!', and 'Logout'. The left sidebar contains a menu with 'Security' selected. The main content area shows the following settings:

- HTTP Encryption:** Force HTTPS for Web access *
- KVM Encryption:** KVM Encryption Off * Try Force
- Group based System Access Control:**
 - Please note: 'Apply' is required, or changes will be lost.
 - Enable Group based System Access Control *
 - Default Action: ACCEPT *

Rule #	Starting IP	Ending IP	Group	Action
1	0.0.0.0	255.255.255.255	All	ACCEPT

Buttons: Append, Insert, Replace, Delete, Apply, Reset to defaults

* Stored value is equal to the default.

Figure 6-27. Device Security

Force HTTPS

If this option is enabled access to the web front-end is only possible using an HTTPS connection. The KVM IP Console Module will not listen on the HTTP port for incoming connections.

In case you want to create your own SSL certificate that is used to identify the KVM IP Console Module refer to the Section called *Certificate*.

KVM encryption

This option controls the encryption of the RFB protocol. RFB is used by the Remote Console to transmit both the screen data to the administrator machine and keyboard and mouse data back to the host. If set to "Off" no encryption will be used. If set to "Try" the applet tries to make an encrypted connection. In case connection establishment fails for any reason an unencrypted connection will be used.

If set to "Force" the applet tries to make an encrypted connection with certificate. An error will be reported in case connection establishment fails.

Group-based System Access Control

This is the IP filtering function, it keeps unauthorized hosts from accessing to the KVM IP Console Module by specifying IP filtering rules. It is important to fully understand what an IP filter is. If you don't fully understand this, you will get unexpected results against your original plan.

The screenshot shows the web interface for the LevelOne IP KVM Switch. The page title is "LevelOne IP KVM Switch" and it indicates "Remote Console connected!". The left sidebar contains navigation options: Home, Console, Remote Control, Virtual Media, User Management, KVM Settings, Device Settings, Network, Dynamic DNS, Security, Certificate, Serial Port, Date/Time, Event Log, and Maintenance. The main content area is titled "Group based System Access Control" and includes a warning: "Please note: 'Apply' is required, or changes will be lost." Below this, there is a checkbox for "Enable Group based System Access Control" which is currently unchecked. A "Default Action" dropdown is set to "ACCEPT". A table lists the current rule:

Rule #	Starting IP	Ending IP	Group	Action
1	0.0.0.0	255.255.255.255	All	ACCEPT

Below the table are buttons for "Append", "Insert", "Replace", and "Delete". At the bottom of the configuration area are "Apply" and "Reset to defaults" buttons. A note at the bottom states: "* Stored value is equal to the default."

Chain rule

The **Chain rule** determines whether the access from the hosts is allowed or not. It can be one of these two values:

- ACCEPT : access allowed
- DROP : access not allowed

The rule can be configured to apply to a particular Group level (All, User, Super, Administrator).

When the KVM IP Console Module receives a TCP packet, it will process the packet with the chain rule depicted below. The process ordering is important; The packet will enter the chain rule 1 first, if meet the rule then take action directly, otherwise go to chain rule 2.

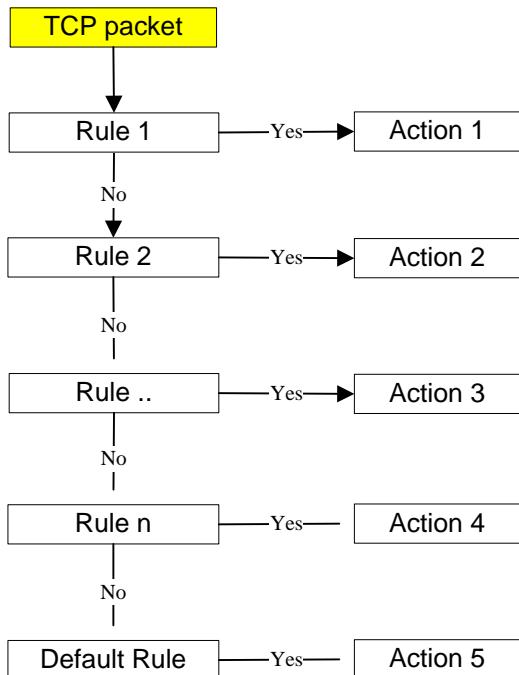

Check the “Enable Group based System Access Control” to edit the rules

Users can add a new IP filtering rule by setting the properties at adding line by **Append** or **Insert**. User can remove a rule by **Remove** or **Delete**.

HTTP Encryption

Force HTTPS for Web access *

KVM Encryption

KVM Encryption Off * Try Force

Group based System Access Control

Please note: 'Apply' is required, or changes will be lost.

Enable Group based System Access Control *

Default Action *

Rule #	Starting IP	Ending IP	Group	Action
1	0.0.0.0	255.255.255.255	All	ACCEPT
2	192.168.123.99	192.168.123.230	super	ACCEPT

* Stored value is equal to the default.

HTTP Encryption

Force HTTPS for Web access *

KVM Encryption

KVM Encryption Off * Try Force

Group based System Access Control

Please note: 'Apply' is required, or changes will be lost.

Enable Group based System Access Control *

Default Action *

Rule #	Starting IP	Ending IP	Group	Action
1	0.0.0.0	255.255.255.255	All	ACCEPT
2	192.168.123.99	192.168.123.230	super	ACCEPT

* Stored value is equal to the default.

6.6.4 Certificate

The screenshot shows the 'Certificate Signing Request (CSR)' configuration page in the LevelOne IP KVM Switch web interface. The page has a blue header with 'LevelOne IP KVM Switch' and 'Remote Console connected!'. A navigation menu on the left includes options like Remote Control, Virtual Media, User Management, KVM Settings, Device Settings, Network, Dynamic DNS, Security, Certificate, Serial Port, Date/Time, Event Log, and Maintenance. The main content area contains a form with the following fields:

- Common name
- Organizational unit
- Organization
- Locality/City
- State/Province
- Country (ISO code)
- Email
- Challenge password
- Confirm Challenge password
- Key length (bits): 1024 (dropdown menu)

A 'Create' button is located at the bottom of the form, with a note below it: '* Stored value is equal to the default.'

Figure 6-28. Certificate Settings

The KVM IP Console Module uses the Secure Socket Layer (SSL) protocol for any encrypted network traffic between itself and a connected client. During the connection establishment the KVM IP Console Module has to expose its identity to a client using a cryptographic certificate. The default certificate comes with KVM IP Console Module device upon delivery is for testing purpose only. System administrator should not rely on this default certificate as the secured global access mechanism through Internet.

However, it is possible to generate and install a new base64 X.509 certificate that is unique for a particular KVM IP Console Module. In order to do that, the KVM IP Console Module is able to generate a new cryptographic key and the associated Certificate Signing Request (CSR) that needs to be certified by a certification authority (CA). A certification authority verifies that you are the person who you claim you are, and signs and issues a SSL certificate to you.

The following steps are necessary to create and install a SSL certificate for the KVM IP Console Module:

- Create a SSL Certificate Signing Request using the panel shown in Figure 6-28. You need to fill out a number of fields that are explained below. Once this is done, click on the button “Create” which will initiate the Certificate Signing Request generation. The CSR can be downloaded to your administration machine with the “Download CSR” button (see Figure 6-29).
- Send the saved CSR string to a CA for certification. You will get the new certificate from the CA after a more or less complicated traditional authentication process (depending on the CA).

- Upload the certificate to the KVM IP Console Module using the “Upload” button as shown in Figure 6-29.

Certificate Signing Request (CSR)

The following CSR is pending:

```
countryName           = TW
stateOrProvinceName  = taipei
localityName          = taipei
organizationName     = test org
organizationalUnitName = test
commonName            = test
emailAddress          = test@test.com
```

Download
Delete

Certificate Upload

SSL Certificate File Browse...

Upload

Figure 6-29. SSL Certificate Upload

```
-----BEGIN CERTIFICATE REQUEST-----
MIIBIDCCATQCAQAwfjELMARGA1UEBHMCPVc3DeANDgNVAATWvRbAXD1aTUPMA0G
A1UEBzMG40Pjcc3UjMSEwCwYDVQQKEwhtOZDND1O9y2eENMAiOAUEE3ME40Yy4dEEM
MA5GA1UEAxEaME8jVc4dEGMB6OC2q0CTb3QGEIARVM477e4EB0ZDND1aobv7CTb2eAN
Bglqtk109eGBAQEFANOB1QAwgTCC2YEAA93rt1Ubs4MYKsAY2z3Lp50y4Dn/w14c
Bp4wXUggpmvzsg6Cab51MY6ZT33UH/acBJyx7KEXY1+s1+9++X+baK3w2yr17HE
j0eND1X2xy1P78Ew99oa)Fos+Y90e9x8Z9Wa5L5hxx9QeLL3qcsrk8NO6)8E MqA)9e
d rOnMk//XCOC AwEAAANWMDQ8C2q0CTb3DQGEI BzEHEw0eN)MONTANB g6qbk109wDE
AQQFAACBq0E46022Ghhf1jD4Cba)k2Q0Db0lycch1otw4AMCydmi45s1YT1015+
2BwRINA1QoTcye jkUTZVMF)Hhsa)3R9MzMYwGp3aehBd8ywe00QwNTeURH10n1f
4596ap1j7W7dU)ac3EgLA7w)w5YVgnd1JkM0ya/sg690D+Gh1kDTg==
-----END CERTIFICATE REQUEST-----
```

Figure 6-30. CSR string

After completing these three steps, the KVM IP Console Module has its own certificate that is used for identifying the card to its clients.

Warning

If you destroy the CSR on the KVM IP Console Module there is no way to get it back! In case you deleted it by mistake, you have to repeat the three steps as described above.

Common name

This is the network name of the KVM IP Console Module once it is installed in the user's network (usually the fully qualified domain name). It is identical to the name

that is used to access the KVM IP Console Module with a web browser (without the "http://" prefix). In case the name given here and the actual network name differ, the browser will pop up a security warning when the KVM IP Console Module is accessed using HTTPS.

Organizational unit

This field is used for specifying to which department within an organization the KVM IP Console Module belongs.

Organization

The name of the organization to which the KVM IP Console Module belongs.

Locality/City

The city where the organization is located.

State/Province

The state or province where the organization is located.

Country (ISO code)

The country where the organization is located. This is the two-letter ISO code, e.g. DE for Germany, or US for the USA. (Note: the country code has to be entered in CAPITAL LETTERS.)

Challenge Password

Some certification authorities require a challenge password to authorize later changes on the certificate (e.g. revocation of the certificate). The minimal length of this password is 4 characters.

Confirm Challenge Password

Confirmation of the Challenge Password

Email

The email address of a contact person that is responsible for the KVM IP Console Module and its security.

Key length

This is the length of the generated key in bits. 1024 Bits are supposed to be sufficient for most cases. Longer keys may result in slower response time of the KVM IP Console Module during connection establishment.

6.6.5 Serial Port

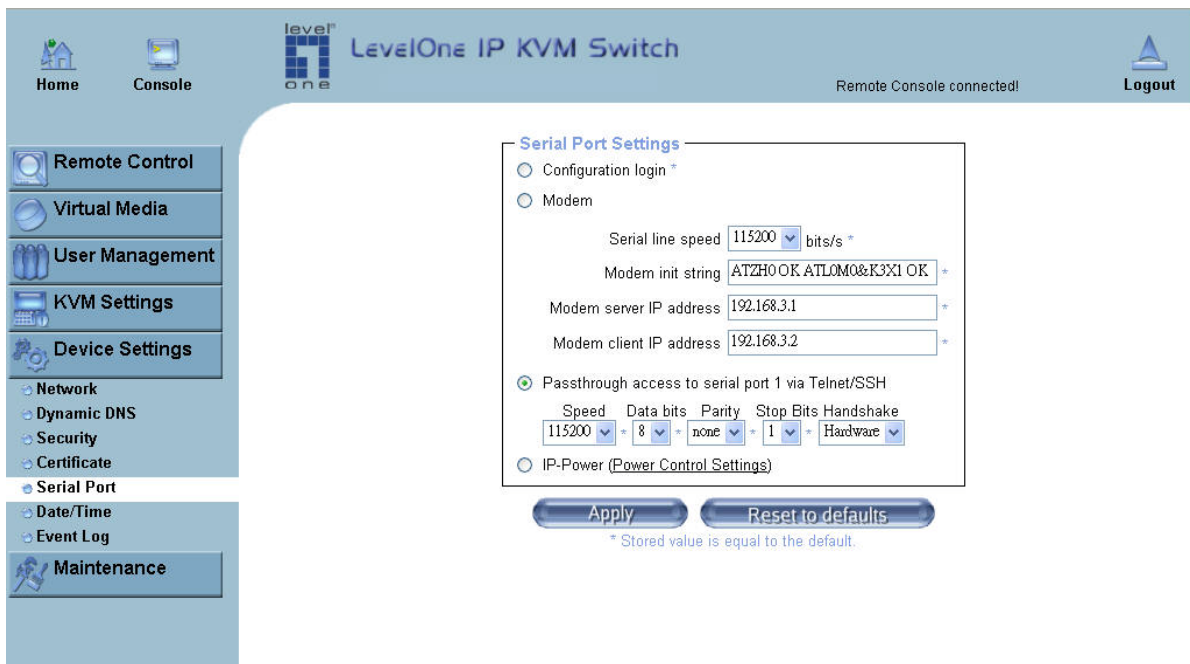

Figure 6-31. Serial Port

The KVM IP Console Module Serial Settings (Figure 6-31) allows you to specify what device is connected to the serial port and how to use it.

Configuration or console login

Do not use the serial port for any special function, use it only for the initial configuration.

Modem

The KVM IP Console Module offers remote access using a telephone line in addition to the standard access over the built-in Ethernet adapter. The modem needs to be connected to the serial interface of the KVM IP Console Module .

Logically, connecting to the KVM IP Console Module using a telephone line means nothing else than building up a dedicated point-to-point connection from your console computer to the KVM IP Console Module. In other words, the KVM IP Console Module acts as an Internet Service Provider (ISP) to which you can dial in. The connection is established using the Point-to-Point Protocol (PPP). Before you connect to the KVM IP Console Module, make sure to configure your console computer accordingly. For instance, on Windows based operating systems you can configure a dial-up network connection, which defaults to the right settings like PPP.

The Modem Settings panel allows you to configure the remote access to the KVM IP Console Module using a modem. The meaning of each parameter will be described below. The modem settings are part of the serial settings panel.

Serial line speed

The speed the KVM IP Console Module is communicating with the modem. Most of all modems available today will support the default value of 115200 bps. In case you are using an old modem and discovering problems try to lower this speed.

Modem Init String

The initialization string used by the KVM IP Console Module to initialize the modem. The default value will work with all modern standard modems directly connected to a telephone line. In case you have a special modem or the modem is connected to a local telephone switch that requires a special dial sequence in order to establish a connection to the public telephone network, you can change this setting by giving a new string. Refer to the modem's manual about the AT command syntax.

Modem server IP address

This IP address will be assigned to the KVM IP Console Module itself during the PPP handshake. Since it is a point-to-point IP connection virtually every IP address is possible but you must make sure, it is not interfering with the IP settings of the KVM IP Console Module and your console computer. The default value will work in most cases.

Modem client IP address

This IP address will be assigned to your console computer during the PPP handshake. Since it is a point-to-point IP connection virtually every IP address is possible but you must make sure, it is not interfering with the IP settings of the KVM IP Console Module and your console computer. The default value will work in most cases.

Passthrough access to serial port via Telnet

Using this option, it is possible to connect an arbitrary device to the serial port and access it (assuming it provides terminal support) via Telnet. Select the appropriate options for the serial port and use the Telnet Console, or a standard Telnet client to connect to the KVM IP Console Module.

IP-Power (Power Control Settings)

For controlling Serial Power Controller.

6.6.6 Date / Time

The screenshot displays the 'Date/Time Settings' page in the LevelOne IP KVM Switch web interface. The page header includes 'LevelOne IP KVM Switch' and 'Remote Console connected!'. The left sidebar contains navigation options: Home, Console, Remote Control, Virtual Media, User Management, KVM Settings, Device Settings, Network, Dynamic DNS, Security, Certificate, Serial Port, Date/Time (selected), Event Log, and Maintenance. The main content area shows the following settings:

- UTC Offset:
- User specified time *
 - Date: / / (mm/dd/yyyy)
 - Time: : : (hh:mm:ss)
- Synchronize with NTP Server
 - Primary Time server:
 - Secondary Time server:

Below the settings, there are two buttons: 'Apply' and 'Reset to defaults'. A note at the bottom states: '* Stored value is equal to the default.' A red warning message is also present: 'The NTP Server configuration is obtained automatically. For proper function, please make sure that the BOOTP/DHCP server used by this device provides correct time server information.'

Figure 6-32. Date / Time

This link refers to a page, where the internal real-time clock of the KVM IP Console Module can be set up (see Figure 6-32). You have the possibility to adjust the clock manually, or to use a NTP timeserver. Without a timeserver, your time setting will not be persistent, so you have to adjust it again, after KVM IP Console Module loses power for more than a few minutes. To avoid this, you can use a NTP timeserver, which sets up the internal clock automatically to the current UTC time. Because NTP server time is always UTC, there is a setting that allows you to set up a static offset to get your local time.

Warning

There is currently no way to adjust the daylight saving time automatically. So you have to set up the UTC offset twice a year properly to the local rules of your country.

6.6.7 Event Log

The screenshot displays the 'Event Log' configuration page in the LevelOne IP KVM Switch web interface. The page is divided into two main sections: 'Event Log Targets' and 'Event Log Assignments'.

Event Log Targets:

- List Logging Enabled *
 - Entries shown per page: *
 - Clear internal log:
- NFS Logging Enabled *
 - NFS Server: *
 - NFS Share: *
 - NFS Log File: *
- SMTP Logging Enabled *
 - SMTP Server: *
 - Receiver Email Address: *
 - Sender Email Address: *
- SNMP Logging Enabled *
 - Destination IP: *
 - Community: *

Click here to view the IP KVM Switch SNMP MIB

Event Log Assignments:

Event	List
Board Message	<input checked="" type="checkbox"/> *
Security	<input checked="" type="checkbox"/> *
Remote Console	<input checked="" type="checkbox"/> *
Host Control	<input checked="" type="checkbox"/> *
Authentication	<input checked="" type="checkbox"/> *

Buttons:

* Stored value is equal to the default.

Figure 6-33. Event Log

Important events like a login failure or a firmware update are logged to a selection of logging destinations (see Figure 6-33). Each of those events belongs to an event group, which can be activated separately.

The common way to log events is to use the internal log list of the KVM IP Console Module. To show the log list, click on “Event Log” on the “Maintenance” page. In the Event Log Settings you can choose how many log entries are shown on each page. Furthermore, you can clear the log file here.

List logging enabled

The common way to log events is to use the internal log list of the KVM IP Console Module. To show the log list, click on “Event Log” on the “Maintenance” page.

Since the KVM IP Console Module's system memory is used to save all the information, the maximum number of possible log list entries is restricted to 1.000 events. Every entry that exceeds this limit overrides the oldest one, automatically.

Warning

If the reset button on the HTML frontend is used to restart the KVM IP Console Module, all logging information is saved permanently and is available after the KVM IP Console Module has been started. If the KVM IP Console Module loses power or a hard reset is performed, all logging data will be lost. To avoid this, use one of the following log methods.

NFS Logging enabled

Define a NFS server, where a directory or a static link have to be exported, to write all logging data to a file that is located there. To write logging data from more than one KVM IP Console Module devices to only one NFS share, you have to define a file name that is unique for each device. When you change the NFS settings and press the button “Apply”, the NFS share will be mounted immediately. That means, the NFS share and the NFS server must be filled with valid sources or you will get an error message.

SMTP Logging enabled

With this option, the KVM IP Console Module is able to send Emails to an address given by the Email address text field in the Event Log Settings. These mails contain the same description strings as the internal log file and the mail subject is filled with the event group of the occurred log event. In order to use this log destination you have to specify a SMTP server, that has to be reachable from the KVM IP Console Module device and that needs no authentication at all (<serverip>:<port>).

SNMP Logging enabled

If this is activated, the KVM IP Console Module sends a SNMP trap to a specified destination IP address, every time a log event occurs. If the receiver requires a community string, you can set it in the appropriate text field. Most of the event traps only contain one descriptive string with all information about the log event. Only authentication and host power events have an own trap class that consists of several fields with detailed information about the occurred event. To receive this SNMP traps, any SNMP trap listener may be used.

Here is a example of all generated event and its event group.

Device successfully started	device
Board Reset performed by user...	device
Firmware upload failed.	device
No firmware file uploaded.	device
Uploaded firmware file discarded.	device

Firmware validation failed.	device
Firmware file uploaded by user...	device
Firmware updated by user...	device
Internal log file cleared by user...	device
Security Violation	security
Host Power	host
Host Reset	host
Connection to Remote Console failed: reason.	console (several)
Connection to client ... established.	console
Connection to client ... closed.	console
Login failed.	auth
Login succeed.	auth

Warning

In contrast to the internal log file on the KVM IP Console Module, the size of the NFS log file is not limited. Every log event will be appended to the end of the file so it grows continuously and you may have to delete it or move it away from time to time.

6.7 Maintenance

6.7.1 Device Information

The screenshot shows the LevelOne IP KVM Switch web interface. The top navigation bar includes 'Home', 'Console', the LevelOne logo, 'LevelOne IP KVM Switch', 'Remote Console connected!', and 'Logout'. The left sidebar contains a 'Maintenance' section with sub-items: Device Information (selected), Event Log, Update Firmware, and Unit Reset. The main content area displays the following device information:

Device Information	
Product Name:	IP KVM Switch
Serial Number:	07070600001
Board ID:	0209019744D2CCB4
Device IP Address:	192.168.50.139
Device MAC Address:	00:11:6B:A0:55:EA
Firmware Version:	04.02.00
Firmware Build Number:	5910
Firmware Description:	Standard Edition
Hardware Revision:	0x0E

Below the device information, there is a link: [View the datafile for support.](#)

The 'Connected Users' section shows:

Connected Users	
super	(192.168.50.147) RC active

Figure 6-34. Device Information

Device Summary

This section contains a summary with various information about this KVM IP Console Module and its current firmware and allows you to reset the card. You may have a look at Figure 6-34 for an example.

The Data file for support allows you to download the KVM IP Console Module data file with specific support information. This is an XML file with certain customized support information like the serial number etc. You may send us this information together with a support request. It will help us to locate and solve your reported problem.

Connected Users	
test (62.238.0.39)	active
test (80.145.25.183)	26 min idle
test (212.183.10.29)	20 min idle
test (62.153.241.228) RC (exclusive)	active

Figure 6-35. Connected Users

Figure 6-35 displays the KVM IP Console Module activity. From left to right the connected user(s), its IP address (from which host the user comes from) and its activity status is displayed. RC means that the Remote Console is open. If the Remote Console is opened in exclusive mode the term (exclusive mode) is added. For more information about this option see the Section called Remote Console Control Bar in Chapter 5.

To display the user activity the last column contains either the term active for an active user or 30 min idle for an user who is inactive for a certain amount of time.

6.7.2 Even log

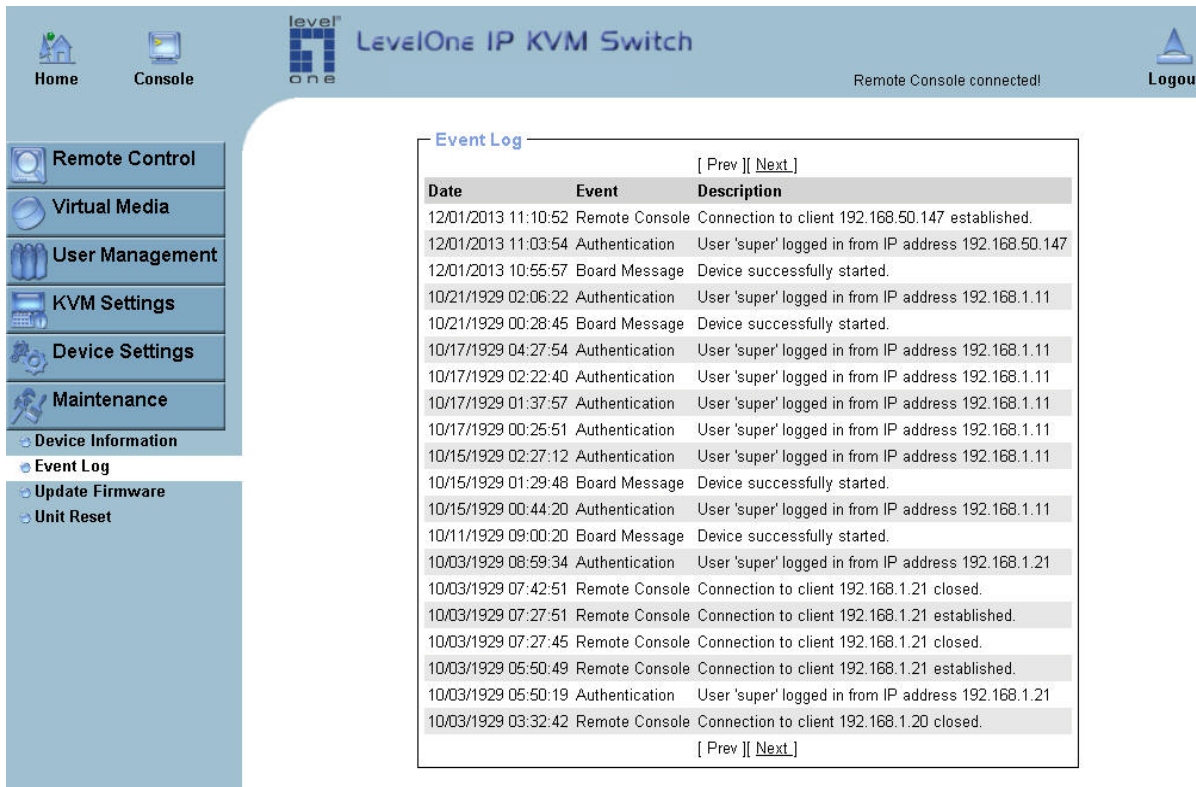

LevelOne IP KVM Switch

Remote Console connected!

Logout

Home Console

Remote Control

Virtual Media

User Management

KVM Settings

Device Settings

Maintenance

Device Information

Event Log

Update Firmware

Unit Reset

Event Log

[Prev] [Next]

Date	Event	Description
12/01/2013 11:10:52	Remote Console	Connection to client 192.168.50.147 established.
12/01/2013 11:03:54	Authentication	User 'super' logged in from IP address 192.168.50.147
12/01/2013 10:55:57	Board Message	Device successfully started.
10/21/1929 02:06:22	Authentication	User 'super' logged in from IP address 192.168.1.11
10/21/1929 00:28:45	Board Message	Device successfully started.
10/17/1929 04:27:54	Authentication	User 'super' logged in from IP address 192.168.1.11
10/17/1929 02:22:40	Authentication	User 'super' logged in from IP address 192.168.1.11
10/17/1929 01:37:57	Authentication	User 'super' logged in from IP address 192.168.1.11
10/17/1929 00:25:51	Authentication	User 'super' logged in from IP address 192.168.1.11
10/15/1929 02:27:12	Authentication	User 'super' logged in from IP address 192.168.1.11
10/15/1929 01:29:48	Board Message	Device successfully started.
10/15/1929 00:44:20	Authentication	User 'super' logged in from IP address 192.168.1.11
10/11/1929 09:00:20	Board Message	Device successfully started.
10/03/1929 08:59:34	Authentication	User 'super' logged in from IP address 192.168.1.21
10/03/1929 07:42:51	Remote Console	Connection to client 192.168.1.21 closed.
10/03/1929 07:27:51	Remote Console	Connection to client 192.168.1.21 established.
10/03/1929 07:27:45	Remote Console	Connection to client 192.168.1.21 closed.
10/03/1929 05:50:49	Remote Console	Connection to client 192.168.1.21 established.
10/03/1929 05:50:19	Authentication	User 'super' logged in from IP address 192.168.1.21
10/03/1929 03:32:42	Remote Console	Connection to client 192.168.1.20 closed.

[Prev] [Next]

Figure 6-36. Event Log List

Figure 6-36 displays the log list including the events that are logged by the KVM IP Console Module.

6.7.3 Update Firmware

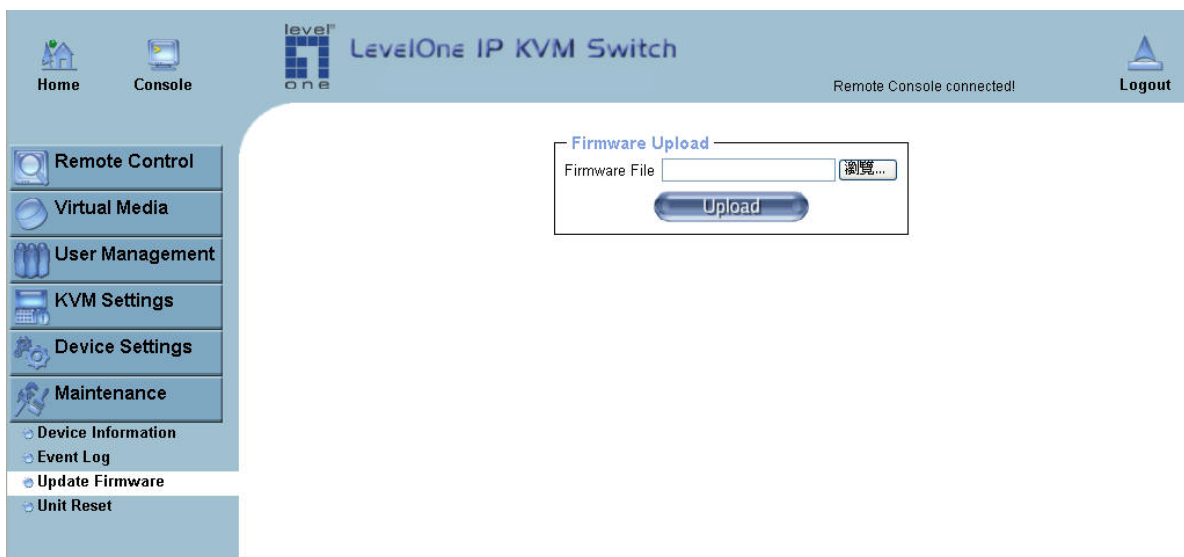

LevelOne IP KVM Switch

Remote Console connected!

Logout

Home Console

Remote Control

Virtual Media

User Management

KVM Settings

Device Settings

Maintenance

Device Information

Event Log

Update Firmware

Unit Reset

Firmware Upload

Firmware File 浏览...

Upload

Figure 6-37. Update Firmware

The KVM IP Console Module is a complete standalone computer. The software it runs is called firmware. The firmware of the KVM IP Console Module can be updated remotely in order to install new functionality or special features.

A new firmware update is a binary file which will be sent to you by email or which you can download from the supplier web site. If the firmware file is compressed (file suffix .zip) then you must unzip it before you can proceed. Under the Windows operating system you may use WinZip from <http://www.winzip.com/> for decompression. Other operating systems might provide a program called unzip.

Before you can start updating the firmware of your KVM IP Console Module the new uncompressed firmware file has to be accessible on the system that you use for connecting to the KVM IP Console Module.

Updating the firmware is a three-stage process:

- Firstly, the new firmware file is uploaded onto the KVM IP Console Module. In order to do that you need to select the file on your local system using the button “Browse” of the Upload Firmware panel. Once the firmware file has been uploaded, it is checked whether it is a valid firmware file and whether there were any transmission errors. In case of any error the Upload Firmware function will be aborted.
- Secondly, if everything went well, you see the Update Firmware panel. The panel shows you the version number of the currently running firmware and the version number of the uploaded firmware. Pressing the button “Update” will store the new version and substitute the old one completely.

Warning

This process is not reversible and might take some minutes. Make sure the KVM IP Console Module 's power supply will not be interrupted during the update process, because this may cause an unusable card.

- Thirdly, after the firmware has been stored, the panel will request you to reset the KVM IP Console Module manually. Half a minute after the reset, the KVM IP Console Module will run with the new firmware version and should be accessible. However, you are requested to login once again.

Warning

The three-stage firmware update process and complete consistency check are making a mistake in updating the firmware almost impossible. However, only experienced staff members or administrators should perform a firmware update. Make sure the KVM IP Console Module 's power supply will not be interrupted!

6.7.4 Unit Reset

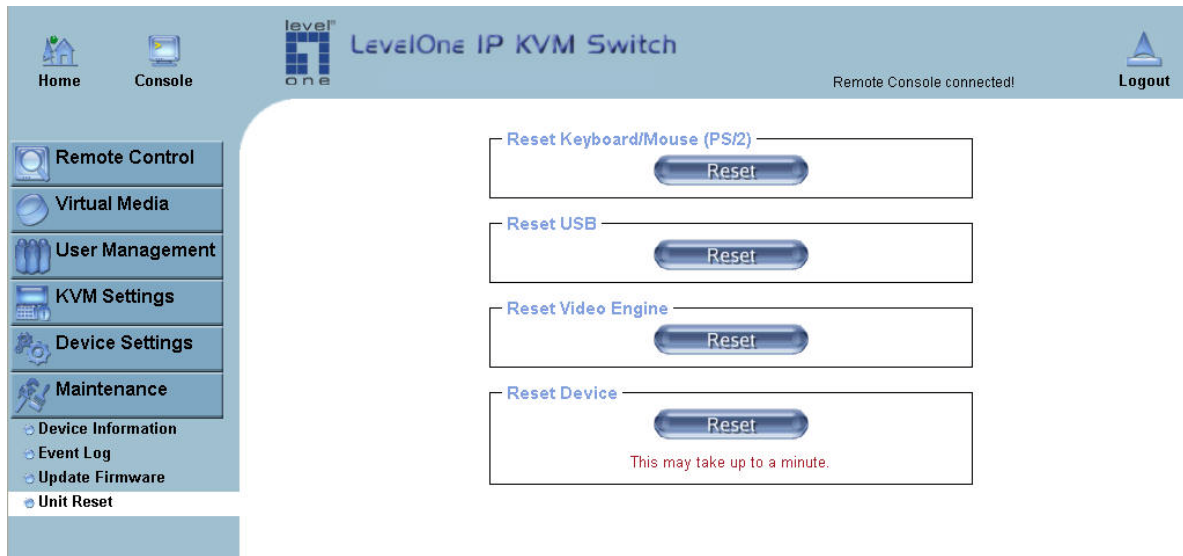

Figure 6-38 Unit Reset

This section allows you to reset specific parts of the device. This involves the both keyboard and mouse, the video engine and the KVM IP Console Module itself. Resetting the card itself is mainly needed to activate a newly updated firmware. It will close all current connections to the administration console and to the Remote Console.

The whole process will take about half a minute. Resetting sub devices (e.g. video engine) will take some seconds only and does not result in closing connections. To reset a certain KVM IP Console Module functionality click on the button Reset as displayed in Figure 6-38.

Note: Only the super user is allowed to reset the KVM IP Console Module.

7. Troubleshooting

The remote mouse doesn't work or is not synchronous

Make sure the mouse settings in KVM IP Console Module match the mouse model. There are some circumstances where the mouse synchronization process could behave incorrectly, refer to Sections 5.4.1 & 6.5.22 for further explanation.

The video quality is bad or the picture is grainy

Try to correct the brightness and contrast settings (see Sections 5.4.1 & 6.5.3) until they

are out of a range where the picture looks grainy. Use the auto adjustment feature to correct a flickering video.

Login on KVM IP Console Module fails.

Was the correct combination of user and password given? On delivery, the user "super" has the password "pass". Moreover your browser must be configured to accept cookies.

The Remote Console window can't connect to KVM IP Console Module.

Possibly a firewall prevents access to the Remote Console. Make sure the TCP port numbers 443 or 80 are open for incoming TCP connection establishments.

No connection can be established to KVM IP Console Module.

Check whether the network connection is working in general (ping the IP address of KVM IP Console Module). If not, check network hardware. Is KVM IP Console Module powered on? Check whether the IP address of KVM IP Console Module and all other IP related settings are correct! Also verify that all the IP infrastructure of your LAN, like routers etc., is correctly configured. Without a ping functioning, KVM IP Console Module can't work either.

Special key combinations, e.g. ALT+F2, ALT+F3 are intercepted by the console system and not transmitted to the host.

You have to define a so-called 'Button Key'. This can be done in the Remote Console settings.

In the browser the KVM IP Console Module pages are inconsistent or chaotic.

Make sure your browser cache settings are feasible. Especially make sure the cache settings are not set to something like "never check for newer pages". Otherwise KVM IP Console Module pages may be loaded from your browser cache and not from the card.

Windows XP doesn't awake from standby mode

This is possibly a Windows XP problem. Try not to move the mouse while XP goes in standby mode.

Can't upload the signed certificate in MacOS X

If an 'internal error' occurs while uploading the signed certificate either change the extension of the file to .txt or add a file helper using the Internet Explorer preferences for this type of file. Make sure that the encoding is plain text and the checkbox 'use for outgoing' is checked. Another possibility is to use a Mozilla based browser.

Every time I open a dialog box with some buttons the mouse pointers are not synchronous anymore

Please check, if you have an option like "Automatically move mouse pointer to the default button of dialog boxes" enabled in the mouse settings of the operating system. This option needs to be disabled.

8. FAQs

The color of remote console displaying a pinkish tint.

If you are experiencing the **remote control screen displaying a pinkish tint** with some graphic cards, please try adjusting the brightness of the remote console by following steps below.

- (1) Click **Video Settings** in Options menu of the remote console.

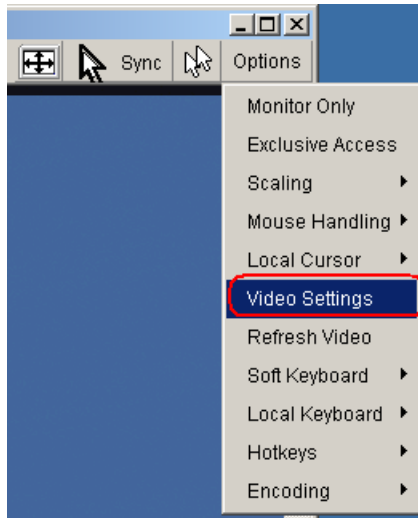

- (2) Adjust the **Brightness** setting until the pinkish tint is reduced or eliminated.

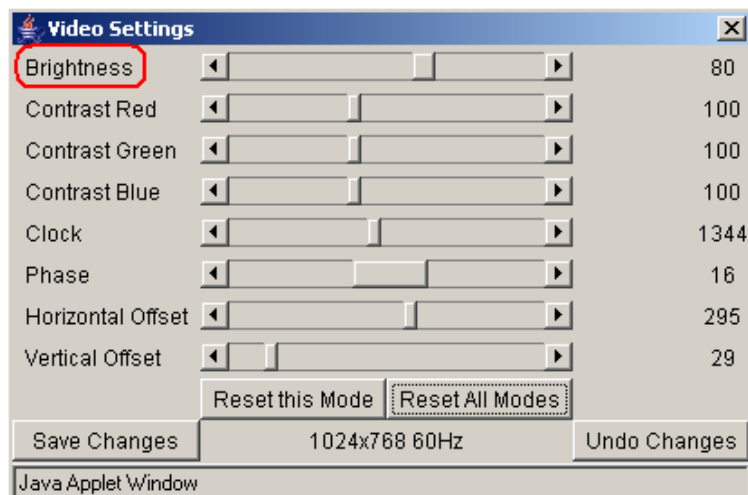

Does any software require on servers which connect to the KVM IP Console Module?

No, the KVM IP Console Module is a 100% hardware solution. No extra software require on servers.

What operating systems does KVM IP Console Module support?

The KVM IP Console Module supports Windows 2000/XP/Vista/Server 2003, Unix, Unix-like OS (Sun Solaris, Linux Fedora Core 6 and above). Mac OSX

What browsers does KVM IP Console Module support?

The KVM IP Console Module support (IE7.0 , IE8.0, Netscape7.0, Mozilla 3.2, Firefox 3.6) and above

Does the KVM IP Console Module work with other brand's KVM switch?

Yes, the KVM IP Console Module can work with most standard KVM.

How many letters the username and password can be set on KVM IP Console

Module?

The KVM IP Console Module accepts 32 letters of username and password.

How many concurrent user of KVM IP Console Module?

The KVM IP Console Module accepts 15 concurrent users.

How many bits of connection encrypted of KVM IP Console Module?

The KVM IP Console Module provides AES 256 bits connection encrypted.

Local mouse and remote mouse didn't sync after doing mouse Intelligent Sync.

Please don't put window on left-up corner of remote console of KVM IP Console Module. Intelligent Sync has to re-calculate the coordinate of mouse from left-up corner on remote console.

9. Addendum

A. Key Codes

Table A.1 shows the key codes used to defines keystrokes or hotkeys for several functions. Please note that these key codes do not represent necessarily key characters that are used on international keyboards. They name a key on a standard 104 key PC keyboard with an US English language mapping. The layout for this keyboard is shown in Figure A.1. However, most modifier keys and other alphanumeric keys used for hotkey purposes in application programs are on an identical position, no matter what language mapping you are using. Some of the keys have aliases also, means they can be named by 2 key codes (separated by comma in the table).

Esc	F1	F2	F3	F4	F5	F6	F7	F8	F9	F10	F11	F12	Prnt	Scr1	Brk					
~	1	2	3	4	5	6	7	8	9	0	-	=	Bsp	Ins	Pos1	Pgup	Num	/	*	-
tab	q	w	e	r	t	y	u	i	o	p	[]	CR	Del	End	Pgdn	7	8	9	+
Caps	a	s	d	f	g	h	j	k	l	;	'	\					4	5	6	
LShift	z	x	c	v	b	n	m	,	.	?	Rshift			Up			1	2	3	CR
Lctrl	Win	Alt	Space					AltGR	Menu	RCtrl	Left	Down	Right				0	.		

Figure A.1: English (US) Keyboard Layout, used for key codes

Key (and aliases)		
0 - 9	SPACE	PAGE DOWN
A - Z	ALTGR	UP
, TILDE	ESCAPE, ESC	LEFT
-, MINUS	F1	DOWN
=, EQUALS	F2	RIGHT
;	F3	NUM LOCK
'	F4	NUMPAD0
<, LESS	F5	NUMPAD1
,	F6	NUMPAD2
.	F7	NUMPAD3
/, SLASH	F8	NUMPAD4
BACK SPACE	F9	NUMPAD5
TAB	F10	NUMPAD6
[F11	NUMPAD7
]	F12	NUMPAD8
ENTER	PRINTSCREEN	NUMPAD9
CAPS LOCK	SCROLL LOCK	NUMPADPLUS,NUMPAD PLUS
\, BACK SLASH	BREAK	NUMPAD/
LSHIFT, SHIFT	INSERT	NUMPDMUL,NUMPAD MUL
RCTRL	HOME	NUMPADMINUS,NUMPAD MINUS
RSHIFT	PAGE UP	NUMPADENTER
LCTRL, CTRL	DELETE	WINDOWS
LALT, ALT	END	MENU

Table A.1: Key Names

B. Video Modes

Table B.1 lists the video modes KVM IP Console Module supports. Please don't use other custom video settings besides of these. If done so, KVM IP Console Module may not be able to detect them.

Resolution (x, y)	Refresh Rates (Hz)
640 x 350	70, 85
640 x 400	56, 70, 85
640 x 480	60, 72, 75, 85, 90, 100, 120
720 x 400	70, 85
800 x 600	56, 60, 70, 72, 75, 85, 90, 100
832 x 624	75
1024 x 768	60, 70, 72, 75, 85, 90, 100
1152 x 864	75
1152 x 870	75
1152 x 900	66
1280 x 960	60
1280 x 1024	60, 75
1600 x 1200	60

Table B.1 Video mode

C. User Role Permissions

Table C.1 lists the user role permissions granted for three user role groups: “Superuser”, “Administrator”, and “User”

	User	Administrator	Superuser
Remote Control: KVM	X	X	X
Remote Control: Remote Power	-	X	X
Remote Control: Telnet Console	X	X	X
Virtual Media	X	X	X
User Management: Change Password	X	X	X
User Management: Users	-	-	X
KVM Settings: User Console	x (w/o Misc. Settings)	X	X
KVM Settings: Keyboard/Mouse	-	X	X
KVM Settings: Video	-	X	X
Device Settings	-	-	X
Maintenance: Device Information	X	X	X
Maintenance: Event Log	-	-	X
Maintenance: Update Firmware	-	-	X
Maintenance: Unit Reset	Keyboard/ Mouse, Video	Keyboard/ Mouse, Video	Keyboard/ Mouse, Video, Device

Table C.1 User Role Permissions

D. KVM IP Console Module port table

Port	Protocol	Purpose
23	Telnet over TCP	Web & Telnet client
80	HTTP over TCP	Web
443	HTTPS over TCP	Web
443	RFB over TCP	Remote Console
443	HTTPS over TCP	Drive Redirection
139	SMB over TCP	CD-ROM Image (Samba Service)
139	SMB over TCP	Floppy disk(Samba Service)
1024	SMB over TCP	Samba Service source port
162	SNMP over TCP	SNMP trap reception port
1024	SNMP over TCP	SNMP source port
443	RFB over TCP	Remote Keyboard and Mouse data

E. Bandwidth Consumption

The preconfigured network speed selection simply results in a different Compression and Color Depth configuration in order to match the different bandwidth limitations of the network type (UMTS, ISDN, etc.)

The following suggested network bandwidth planning table for KVM IP Console Module installation is from the test results with 3D-Labyrinth screen saver at Resolution 800x600, the worst case consuming the highest network bandwidth.

	Compression	Color Depth	Used Bandwidth	Comment
Video Optimized	Video Optimized	8 bit	3.0 - 3.3 MB/s	uncompressed, synchronized video data, most bandwidth needed
Video Optimized (high color)	Video Optimized	16 bit	4.3 - 5.0 MB/s	uncompressed, synchronized video data, most bandwidth needed
LAN (high color)	0 (no compression)	16 bit	1.0 - 1.3 MB/s	uncompressed video data
LAN	0 (no compression)	8 bit	500 - 700 kb/s	uncompressed video data
DSL	2	8 bit	110 - 140 kb/s	slower video because of compression
UMTS	4	8 bit	80 - 100 kb/s	slower video because of compression
ISDN 128k	6	4 bit	20 - 30 kb/s	16 colors
ISDN/Modem V.90	7	2 bit	13 - 17 kb/s	gray scale
GPRS/HSCSD	8	2 bit	5 - 7 kb/s	gray scale
GSM Modem	9 (best compression)	1 bit	1 - 3 kb/s	black&white video

F. Cable diagrams

VGA Cable: HDDB15 Male to Male

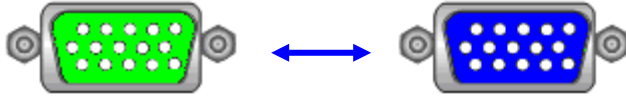

USB 2.0 Cable: USB A-B cable

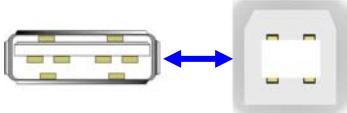

CAT5/5E/6 Straight Through UTP/STP Cable

Straight through RJ45 color coding - EIA/TIA 568B

