



# **LevelOne**

## **KVM-0831/KVM-1631**

8/16-Port Combo KVM Switch  
w/ Expansion Slot

## **User Manual**



# Safety

## FCC

This equipment has been tested and found to comply with Part 15 of the FCC Rules. Operation is subject to the following two conditions:

- (1) This device may not cause harmful interference
- (2) This device must accept any interference received, including interference that may cause undesired operation.

## CE

This equipment is in compliance with the requirements of the following regulations: EN 55022: CLASS B



# Table of Contents

<b>1. INTRODUCTION .....</b>	<b>1</b>
KEY FEATURES .....	2
PACKAGE CONTENT .....	2
OPTIONAL CABLES & MODULE .....	3
SYSTEM REQUIREMENT .....	3
FRONT PANEL .....	4
REAR PANEL .....	5
EXPANSION SLOT .....	6
<b>2. HARDWARE INSTALLATION .....</b>	<b>7</b>
STEP 1 RACK MOUNTING .....	7
STEP 2 LOCAL CONSOLE .....	7
STEP 3 USB KEYBOARD .....	7
STEP 4 USB MOUSE .....	8
<i>Remote Console (Optional Module ACC-1000)</i> .....	8
STEP 5 PC PORT CONNECTION .....	9
STEP 6 DOUBLE CHECK .....	9
STEP 7 POWER ON .....	9
<b>3. OPERATION .....</b>	<b>10</b>
<b>4. DAISY CHAIN CONNECTION .....</b>	<b>11</b>
OPERATE AND DISPLAY .....	12
DISPLAY EXAMPLE .....	12
<b>5. ON SCREEN DISPLAY .....</b>	<b>13</b>
<i>Hotkey</i> .....	13
<i>OSD Menu</i> .....	16
<i>Login Window</i> .....	17
<i>Port Name</i> .....	18
MAIN MENU .....	19
<i>LANGUAGE</i> .....	20
<i>PORT NAME EDIT</i> .....	20
<i>PORT SEARCH</i> .....	21
<i>USER SECURITY</i> .....	21
<i>ACCESS LIST</i> .....	22
<i>HOTKEY</i> .....	22

<i>TIME SETTINGS</i> .....	23
<i>OSD MOUSE</i> .....	23
<i>FIRMWARE UPGRADE</i> .....	24
<b>6. TECHNICAL SPECIFICATION</b> .....	<b>25</b>
<b>7. TROUBLESHOOTING</b> .....	<b>26</b>

# 1. Introduction

---

Thank you for purchasing LevelOne KVM-0831/1631 Combo KVM Switch. The KVM Switches offer the most reliable and efficient way of managing multiple computers in server rooms where space is at a premium. On Screen Display (OSD) features computer naming, computer selection, status indication, auto scan and much more. Up to 128 servers can be easily managed by cascading multiple KVM switches to expand the capacity. Revolutionized video enhancement technology ensures superb quality up to 1920 x 1440.

KVM-0831/1631 supports host PC with PS/2 and USB interface. The convenient HDDB-15 to VGA+PS/2+USB cable allows user to connect to different kinds of PC interfaces by the same cable. Users no longer need to prepare two kinds of cables for their PCs or servers with different kinds of interfaces. Users can save their time and cost when building their system.

Besides the USB console port, KVM-0831/1631 support an optional module which provide Cat.5 remote console for users to access KVM switch remotely with the KVM-9007 Cat.5 Receiver. After making connection between KVM switch and Cat.5 receiver by Cat.5/5e/6 cable, users can control their system remotely and the distance can be up to 300 meters. Users can use their existing LAN cables to do the remote control, this also saves their cost and reduce the complexity. Some server room environments are too noisy for people or unsuitable to work there for a long time, this remote control feature is an ideal solution for these situations.



KVM-0831



KVM-1631

## Key Features

- 8/16 ports Combo KVM switch with 19" rack-mounted design
- [Combo interface with PS/2 and USB PC supports \\*](#)
- Supports DOS, Win98SE/2000/XP, Netware, Unix, Linux, Mac, Sun Microsystems
- High VGA resolution - up to 1920X1440, bandwidth: 200MHz
- Easy PC selection via On Screen Display Menu, Push buttons, Hot keys
- Support password protection and search PC server name
- Auto scan mode for monitoring PCs and flexible scan time from 5~99 seconds
- LED display for easy status monitoring
- Buzzer sound for switching port confirmation
- Built-in one daisy chain port for cascading up to 8 KVM-0831/KVM-1631
- [Provides one expansion slot and can be used for KVM Cat.5 Console or future extension functionality \\*](#)

## Package Content

KVM-0831 / KVM-1631	1 PCS
Power Adapter DC12V, 1.0A	1 PCS
Rack Mount Kit	1 SET
Rubber Feet	1 SET
User Manual	1 PCS

### Note:

\* Use either PS2 or USB port only for the PC port connection on the same PC

\* The optional **ACC-1000 KVM Cat.5 Console** expansion module allows user control the KVM-0831/KVM-1631 remotely through standard Cat.5 cable for up to 300 meters.

\* The **KVM-9007 Cat.5 Receiver** is required for the Cat.5 remote control, it is highly recommended to use Cat.5e cable when the connection is shorter than 150 meters, and to use Cat.6 cable when the connection is between 150 and 300 meters.

## Optional Cables & Module

All cables and modules are optional; please contact your local distributor for more information

Model No	Description
ACC-1000	<a href="#">KVM Cat,5 Console Module</a>
ACC-2101	1-to-3 1.8m cable for PS/2 and USB port
ACC-2102	1-to-3 3.0m cable for PS/2 and USB port
ACC-2103	1-to-3 5.0m cable for PS/2 and USB port
ACC-2109	90cm Daisy Chain cable
KVM-9007	KVM Cat.5 Receiver

## Connection Diagram

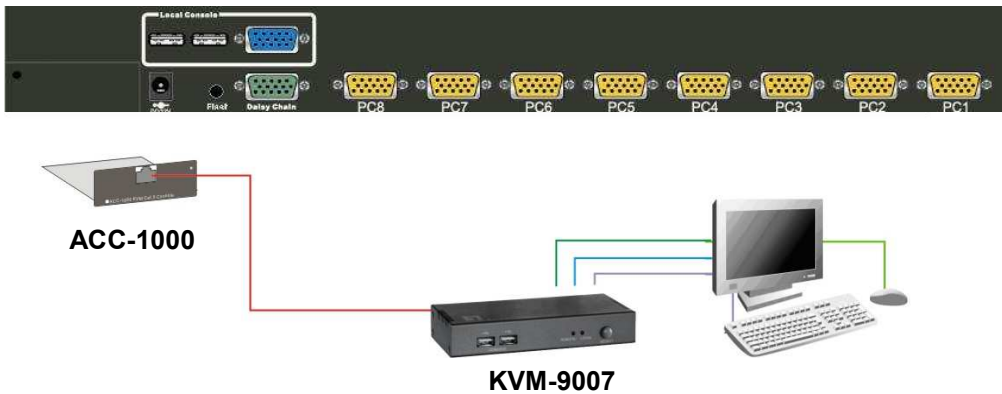

## System Requirement

Model No.	KVM-0831 / KVM-1631
Local Console side	One VGA Monitor One USB Keyboard One USB Mouse
Computer side	HDDB 15 pin male to HDDB 15 pin + Mini Din 6 pin + USB special cables



# Front Panel

## KVM-0831

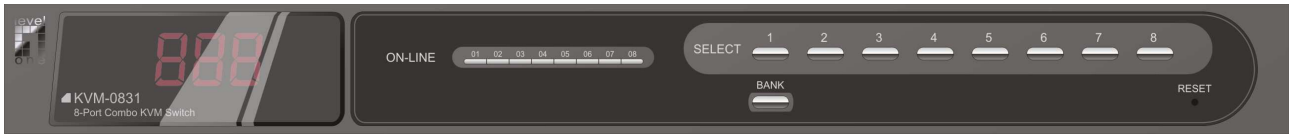

## KVM-1631



### 7-Segment BANK LED indication :

This KVM switch has three 7-segment LEDs to indicate which bank and port is selected. The first digit of 7-segment LED indicate the bank you selected and the last two digits indicate which port you select on this bank.

### ON-LINE LED indication:

When the host PC is powered on, the ON-LINE LED (Blue color) of corresponding port will be lit in solid blue. If the PC is powered off or PC port is empty, the power LED won't be lit.

### The BANK button:

If you want to view the KVM switch on next bank, please press "BANK" button. The bank LED will be changed from bank 1 to the maximum daisy chain level and then to press "BANK" push button once back to the bank 1.

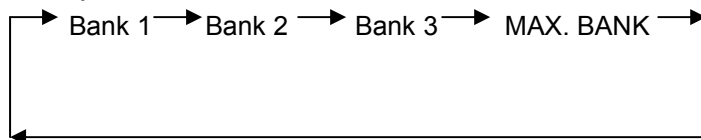

### Push Buttons (1~8):

To switch from one to another port, please press the push button for the destination port on the front panel.

### SHIFT Button:

For 16 ports KVM switch, please press "SHIFT" button (9-16 LED on) and individual button 1~8 simultaneously in order to select the port 9 to port 16.

For example: Pressing "SHIFT" button and button 5 simultaneously, the thirteen PC port select LED is selected.

### Note:

ON LINE status may still lit on after PC/Server shut down when USB KB/Mouse connected to PC ports. It's because the USB port is powered continuously by PC/Server motherboards, even it shut down already.

# Rear Panel

## KVM-0831



## KVM-1631



### PC Port Special Cable: (ACC-2101, ACC-2102, ACC-2103)

HDDB15 pin male to one HDDB 15 pin male, one Mini Din 6 pin and one USB special cables



### Daisy Chain Cable: (ACC-2109)

HDDB15 pin Male to Male

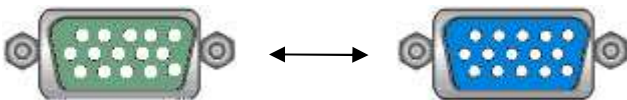

## Expansion Slot



The Expansion Slot extends functionality with optional module add-on, such as the **ACC-1000 KVM Cat.5 Console** module which allows IT people to manage the system away from server room for up to 300 meters.

## ACC-1000 KVM Cat.5 Console (optional)

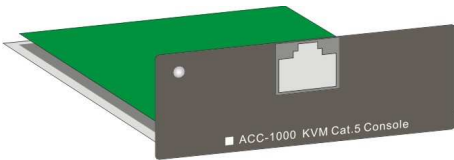

To be able remote control through Cat.5 Console, use requires the standard **Cat.5 cable** and **KVM-9007 KVM Cat.5 Receiver**. Cable quality can cause image display differently, ask your local distributor for help if you experience troubles.

## Cat.5/5E/6 Straight Through UTP/STP Cable

8P8C

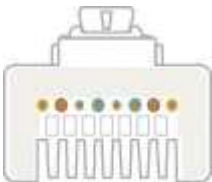

Pin	Wire Color	Pair	Function
1	White/Orange	2	T
2	Orange	2	R
3	White/Green	3	T
4	Blue	1	R
5	White-Blue	1	T
6	Green	3	R
7	White/Brown	4	T
8	Brown	4	R

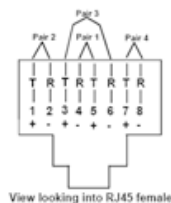

## Connection Diagram



## 2. Hardware Installation

Before installation, please make sure all of peripherals and computers have been turned off. This example of installation is based on KVM-0831 and the procedure of KVM-1631 is the same.

### Step 1 Rack Mounting

KVM-0831 / KVM-1631 can be mounted in a standard 19-inch equipment rack or on a desktop. To mount to a rack, attach the brackets to the device using the screws provided in the rack-mount Kit.



### Step 2 Local Console

Connect the monitor to the HDB-15 female port of the local console ports on the back of the KVM.



### Step 3 USB Keyboard

Connect an USB keyboard to the KVM Switch.

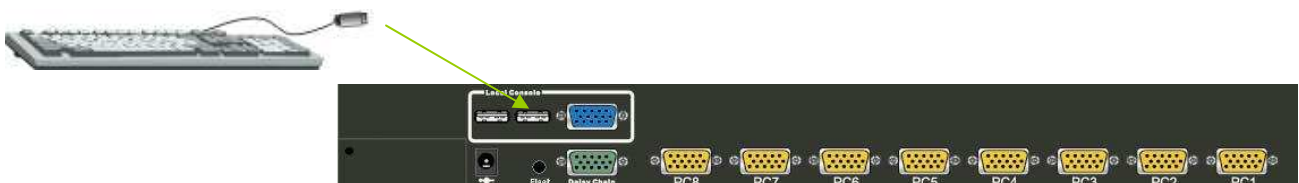

## Step 4 USB Mouse

Connect an USB mouse to the KVM Switch.

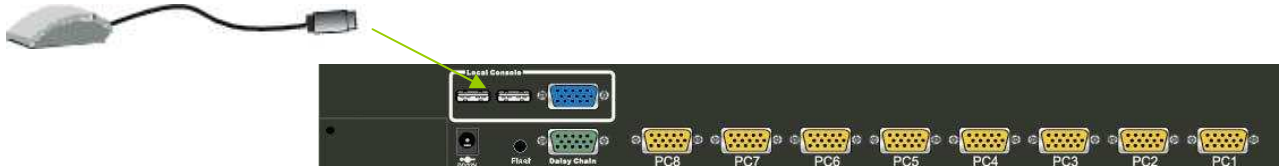

## Remote Console (Optional Module ACC-1000)

Extending your PC console up to 300 meters away:

- (1) Make sure that the Cat.5 cable is straight through type.
- (2) Plug one end of Cat.5 cable into the remote console port of KVM switch and the other end of Cat.5 cable into the RJ-45 port of **KVM-9007** Cat.5 receiver.
- (3) Connect keyboard, mouse and monitor to the Keyboard/Mouse port and Monitor port of KVM-9007.
- (4) Connect Local PC to KVM-9007 by using the HDDB-15 to the VGA+PS/2+USB cable
- (5)

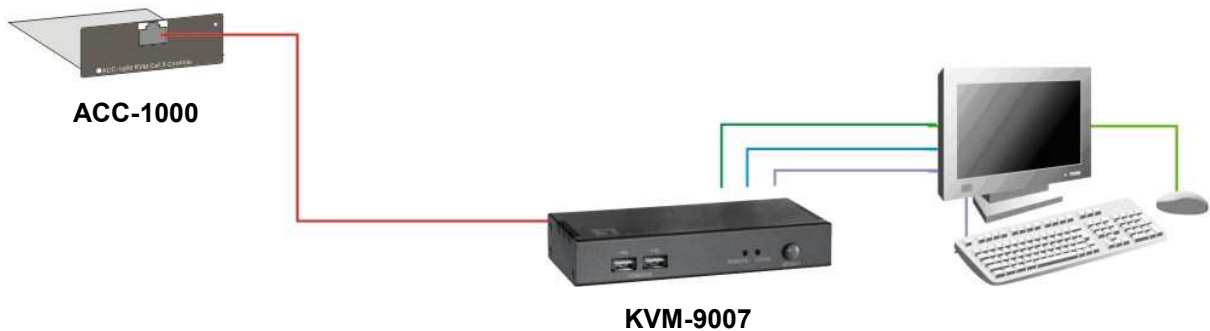
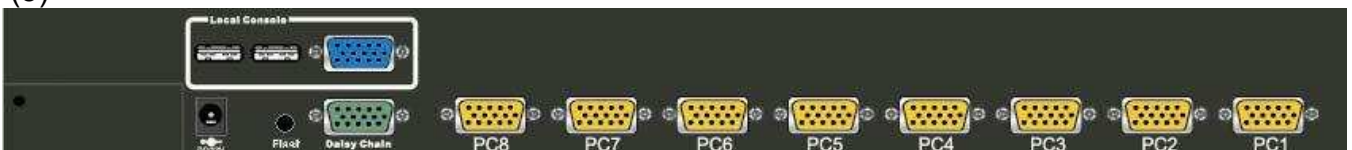

## NOTE:

1. Local console and Remote console of the KVM switch have the same priority to control computers connected to the KVM switch. The display output is the same at the local and remote console monitors. The priority mechanism is: the first move port has the priority and will release the priority if it did not keep input for 2 seconds.
2. If the video signal is foggy or un-cleared on the screen, please check if the VGA connector
3. For the best display result, it is highly recommended to use Cat.6 cable when the connection distance is longer than 150 meters.

## Step 5 PC Port Connection

The PC port connector is HDDB-15 pin type. Plug the HDDB-15 end of the KVM cable (HDDB-15 to VGA+PS/2+USB type) into PC port on the rear of KVM switch unit. (ACC-2101/ACC-2102/ACC-2103).

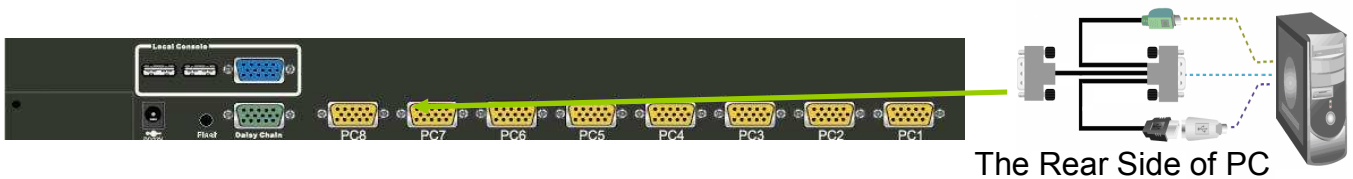

- (a) For PS/2 computers - Plug the PS/2 connector into the PS/2 mouse port, use the USB to PS2 adaptor to convert the USB connector into PS/2 interface, then connect it to the keyboard port of PC.
- (b) For USB computers - Plug the USB connector into the USB port of PC and no need to connect the PS/2 connector to the PC.

## Step 6 Double Check

Double-check all of the connections. You can check the color of keyboard and mouse connector to make sure the keyboard and mouse connectors are plugged to the correct ports.

## Step 7 Power On

Attach the power supply to the KVM unit and plug the other end into a receptacle. The Port 1 LED will be lit up, and you will hear a beep. Please switch on your monitor.

**Note:** Please remember to plug the power adapter. Although the PCs connected to KVM Switch are able to support enough power to the stand alone switch, KVM switch still needs a power adapter for daisy chain more banks. Unexpected status may occur If you try to daisy chain more KVM switches without plugging the power adapter.

### 3. Operation

---

#### **The power on state of KVM-0831/1631:**

When you power on the KVM switch, it will prompt a login window for key-in USER NAME and PASSWORD. For more details, please refer to [OSD section](#)

#### **The push buttons 1~8:**

To switch from one to another port, please press the push button for the destination port on the front panel. For 16 ports KVM switch, please press “shift” button (9-16 LED on) and individual button 1~8 simultaneously in order to select the port 9 to port 16.

For example: Pressing “shift” button and button 5 simultaneously, the thirteen PC port select LED is selected.

#### **ON-LINE LED indication:**

When the host PC is powered on, the ON-LINE LED of corresponding port will be lit in solid blue. If the PC is powered off or PC port is empty, the power LED won't be lit.

#### **The BANK button:**

If you want to view the KVM switch on next bank, please press “BANK” button. The bank LED will be changed from bank 1 to the maximum daisy chain level and then to press “BANK” push button once back to the bank 1.

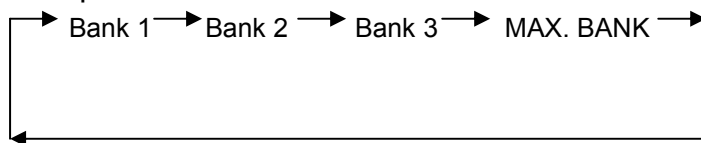

#### **7-Segment BANK LED indication :**

This KVM switch has three 7-segment LEDs to indicate which bank and port is selected. The first digit of 7-segment LED indicate the bank you selected and the last two digits indicate which port you select on this bank.

#### **Keyboard Hot Key Commands:**

You can switch between the banks or ports through simple hot key. The default hot key is pressing the “**CAPS LOCK**” key twice within 2 seconds, and the user could change hot key as your convenient application. If you prefer to use a different hot key, you change the default hot key in the OSD menu. Refer to the [Hotkey section](#) for more information.



## 4. Daisy Chain Connection

**Note:**

1. Make sure that power to all the devices you will be connecting up have been turn off. You must unplug the power cords of any computers.
2. We do not recommend to cascading different models through the Daisy Chain connection.

- A. Turn on the KVM switches first then connect the **daisy chain cable** (ACC-2109). Use one end of daisy chain cable to connect the chain in of daisy chain ports of bank 1 KVM switch and the other end of daisy chain cable for chain out of daisy chain ports of bank 2 KVM switch.
- B. Please repeat step A to daisy chain more bank as you want. Add the KVM switch one at a time The maximum daisy chain bank is eight levels. The bank 1 OSD menu and front panel button will be used to do while KVM system after daisy chain, other KVM switch OSD will be disabled. If you daisy chain KVM-830 and KVM 1631 please use the 16 port at the bank 1.

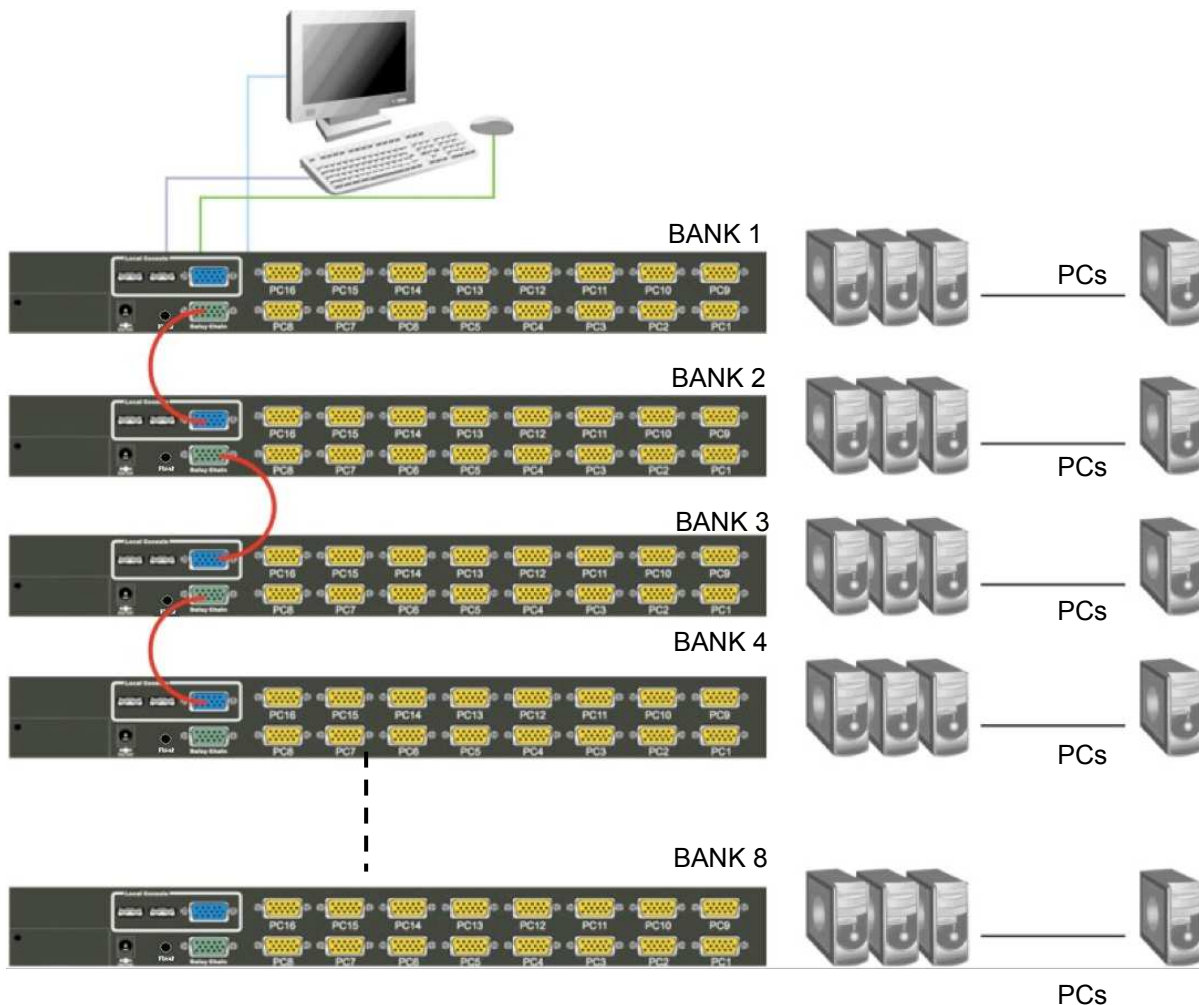



# Operate and Display

## The BANK button:

If you want to view the KVM switch on next bank, please press “BANK” button. The bank LED will be changed from bank 1 to the maximum daisy chain level and then to press “BANK” push button once back to the bank 1.

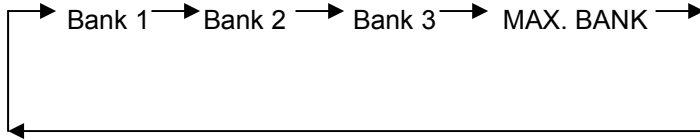

## Display Example

If multiple KVM switches are cascading, user can control all the devices through BANK1 (Master) only. The following diagram shows the BANK1, Port1 is in control right now, and **SELECT** button is switching between PCs/Servers within BANK1.

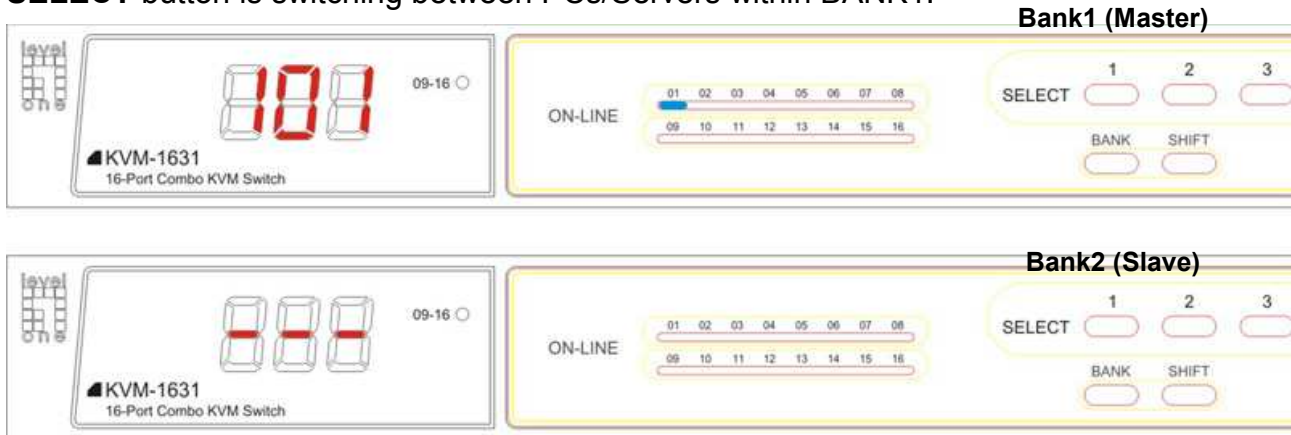

After press **BANK** button to switch to BANK2, the following diagram shows the BANK2, Port1 is in control right now, and **SELECT** button is switching between PCs/Servers within BANK2.

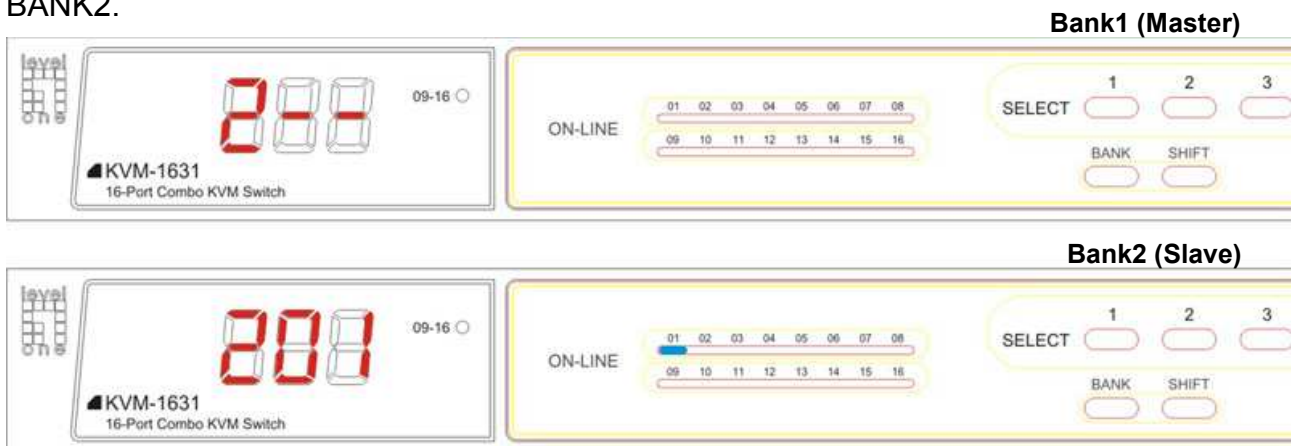

## 5. On Screen Display

---

User can control the KVM switch by three ways – front panel **Control Buttons**, **OSD** (On-Screen Display), or **Hot key** commands through the Console keyboard. It takes approximately 1-2 seconds for the video signal to refresh after switching computers. Re-synchronization of the mouse and keyboard signals also occurs. This is normal operation and ensures that proper synchronization is established between the Console and the connected computers

### Hotkey

You can conveniently command KVM switch through a simple hot key sequence. To send commands to KVM switch, you must **press the hotkey (default Caps Lock) twice within 2 seconds**. You will hear a beep sound confirming entering Hotkey mode. If you do not press any key during Hotkey mode over 2 seconds the Hotkey mode will be escaped and back to Normal state. The default hotkey is **Caps Lock** but you can change hotkey as your application convenience. If you prefer to use other hotkey, please go to OSD menu and change the default hotkey to the other. **Note: OSD accepts capital letters only. (Uppercase)**

Command	Function
<b>Space bar</b>	Bring up the OSD overlay screen
↑	Moving up
↓	Moving down
<b>[1,2,...,8] bank, [01, 02,...,32] port</b>	<ul style="list-style-type: none"> <li>■ The first digit is bank number starting with “1”. The KVM switch on the Daisy chain line is on bank 1 (the Master). A standalone KVM switch also on bank 1.</li> <li>■ The second &amp; third digits are port number starting with “01”</li> </ul>
<b>PgUp</b>	Previous bank
<b>PgDn</b>	Next bank
<b>B</b>	Turn <b>beep sound</b> on/off
<b>L</b>	To enable/disable the <b>Screen Saving</b> function and 10min auto-logout function. This function is <b>default OFF (Disable)</b> .
<b>P</b>	To <b>log out the OSD</b> . If Security is enabled it will show up the Login window waiting for username and password. If Security is disabled it will show up the Status window
<b>R</b>	For SUPERVISOR to set the OSD back to factory default value (except User Security settings).
<b>S</b>	For SUPERVISOR to activate the <b>Auto-Scan</b> function
<b>U</b>	For SUPERVISOR to turn Security function on/off. If the Security is off, we

	don't need user name & password to access to the KVM system. The Security function is <b>default OFF (Disable)</b> .
--	--

**Example #1** – To bring up the OSD overlay window, press “**Caps Lock**”, “**Caps Lock**”, and the “**Space Bar**”. Immediately, the OSD overlay screen will appear. The superimposed menu screen is generated by the KVM switch, and does not affect your computers or software function in any way.



**Example #2** – To switch to Bank 1 Port1, press “**Caps Lock**”, “**Caps Lock**”, and “**1**”, “**0**”, “**1**”.

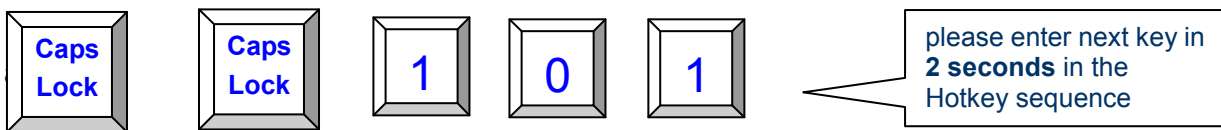

Actually there are two methods to bring up the OSD overlay window.

1. **Activate OSD by press Hotkey** --- press Hotkey twice then press Space bar.
2. **Activate OSD by Mouse** ---

Press and hold the **left button** of the mouse and hit the **Esc** key to show the **Status** screen.

Press and hold the **right button** of the mouse and hit the **Esc** key to bring up the Main Menu.

## OSD Menu

OSD Menu provides a menu-driven interface to control the KVM switch.

This OSD Menu has four types of display screens:

1. **Login Window** --- When powering on this KVM switch, it will prompt a login window and ask for user name and password. This KVM system can setup one **SUPERVISOR** and eight **USERS**. SUPERVISOR can access to all OSD functions. USER can access to PORT NAME and PORT SEARCH only.
2. **Status screen** --- after the log in the Status screen will show up to display the current port settings and Hotkey type.
3. **Port Name** --- this menu displays port status, and you can switch to other port right here.
4. **Main Menu** --- there are eight menus to operate. They are listed as below:

MAIN MENU	Function
01 LANGUAGE	OSD language selection
02 PORT NAME EDIT	PORT NAME modification
03 PORT SEARCH	Quick searching by port name
04 USER SECURITY	Change password
05 ACCESS LIST	Define user access authority
06 HOTKEY	Change Hotkey
07 TIME SETTINGS	Modify auto-SCAN time interval
08 OSD MOUSE	Modify OSD MOUSE speed

## Login Window

Power on local console monitor, and power on the KVM Switch by plug in the power adapter, the Login window will show up waiting for user name and password.

The Login

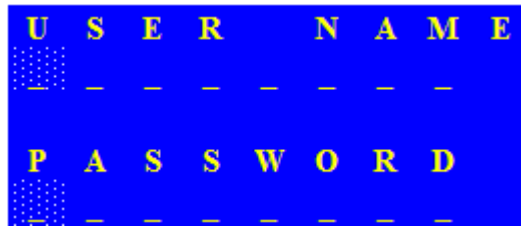

The default is SUPERVISOR and default user name is eight zeros “00000000”.  
The default password is eight zeros “00000000”.

After login or port switch by panel button, OSD or Hotkey, the **Status** screen will show up to display the information of current settings -- one digit BANK NUMBER, two-digit PORT NUMBER, PORT NAME, and current Hotkey settings. Pressing any key or moving mouse will let the Status screen disappeared.

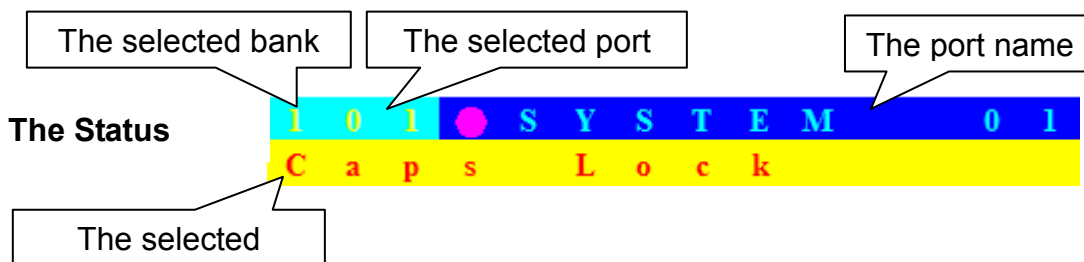

### Auto-LOGOUT function

- In Login window, if no input for username and password over 1 minute, the screen will disappear. Hit any key to bring up the Login window again.
- At normal operation, if no input from the console keyboard or mouse over 10 minutes the KVM switch will turn off the screen display and show up Login window asking for user name and password. One more minute of keyboard/mouse inactivity, the monitor will be turned off (notice the monitor LED turns from green color to orange color).

## Port Name

The first page shows the current port name and the selected port, and the operation hint.

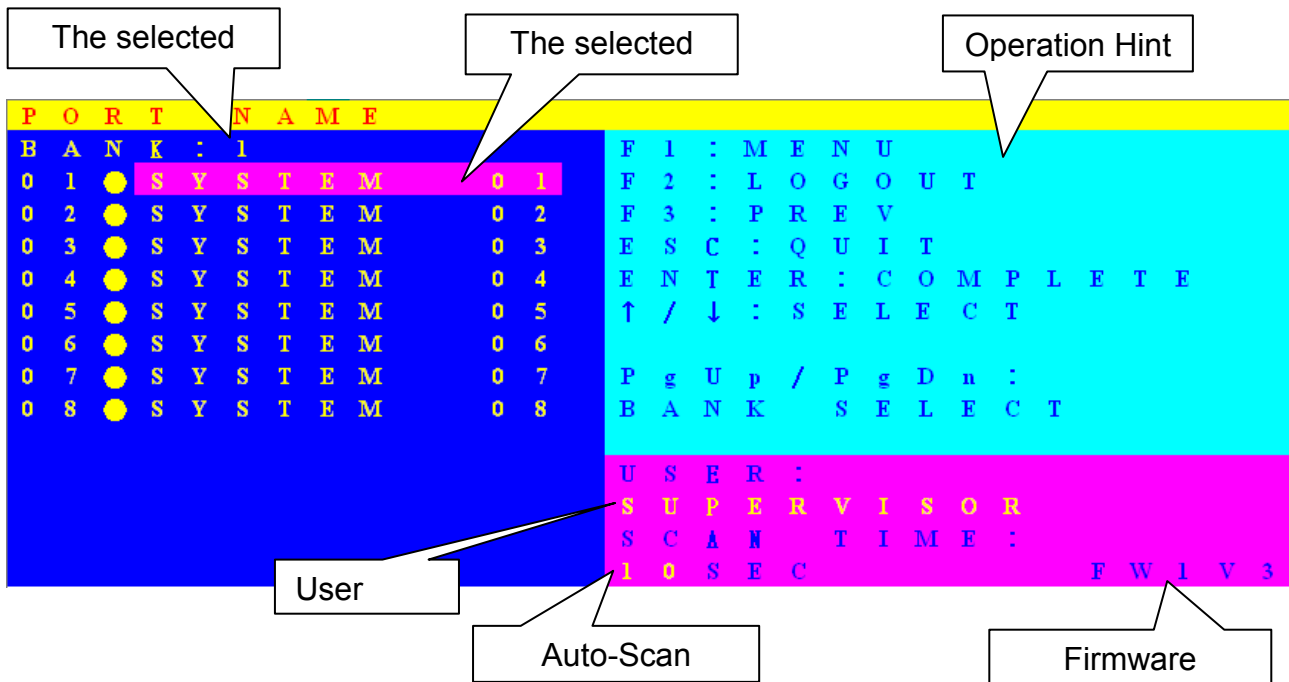

OSD Function Key	Description
F1	Go to the Main Menu
F2	To log out the OSD. If Security is enabled it will show up the Login window waiting for username and password. If Security is disabled it will show up the Status window
F3	Previous Menu
Enter	Switch to the selected port
↑ / ↓	Select the port (press Enter to switch)
PgUp	Previous Bank
PgDn	Next Bank
Esc	Exit
1	Show ports 01 ~ 08
2	Show ports 09 ~ 16
3	Show ports 17 ~ 24
4	Show ports 25 ~ 32

- **USER** --- There are two types of user levels: **SUPERVISOR** and **USER**. The default is

**SUPERVISOR. SUPERVISOR** can setup and change the OSD settings at Main Menu.  
**USER** can only do the port switch and port search.

- **SCAN TIME** --- This is the time interval for auto-scan function. When auto-scan function is activated, the KVM switch will auto-scan the host port one by one in the interval as setting. Notice that the port without connecting to a computer/server will be skipped over on the scan.
- The numeric keypad is not supported, while in OSD screen, the arrow keys, PgUp, PgDn, and Enter keys are supported.

## Main Menu

There are eight menus to choose from.

M A I N M E N U	
S E L E C T O P T I O N :	
0 1	L A N G U A G E
0 2	P O R T N A M E E D I T
0 3	P O R T S E A R C H
0 4	U S E R S E C U R I T Y
0 5	A C C E S S L I S T
0 6	H O T K E Y
0 7	T I M E S E T T I N G S
0 8	O S D M O U S E



## LANGUAGE



The OSD supports eight languages: English, French, German, Italian, Spanish, Simplified Chinese, Japanese, and Russian.

The default language is **ENGLISH**. Moving the cursor by keyboard (Up Arrow key “↑” or the Down Arrow key “↓”) or mouse to select the language you like.

## PORT NAME EDIT

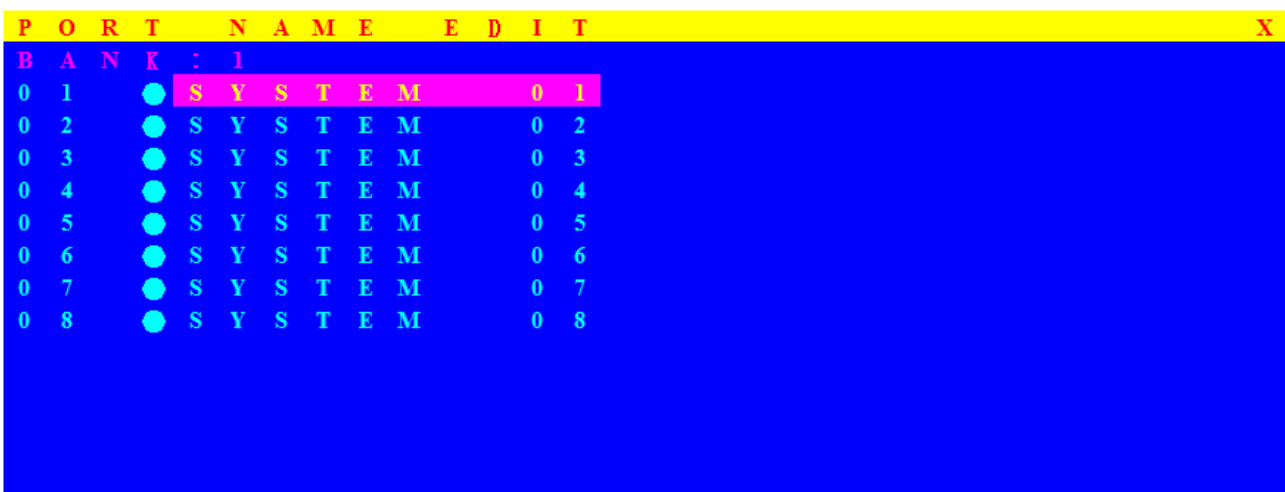

The first line bar is Bank number, following lines are port name list.

Use keyboard (Up Arrow key “↑”, Down Arrow key “↓”) or mouse to select the port. After select the port, you can either press the **Enter** Key, or move the cursor to port name and double click **left button** of mouse to switch the port immediately. Press **PgUp** key or **PgDn** key for selecting the previous or next Bank.

Press **Enter** key to change the port name. Press **Esc** key to cancel the editing without any change or press **Enter** key to complete the editing.

## PORT SEARCH



Search the computer by port name. Enter “\*” will show the all the port names.

## USER SECURITY



There are two types of user levels: **SUPERVISOR** and **USER**. There is one SUPERVISOR and up to eight USERS can be configured.

Press the **Enter** key or right button of mouse for editing. The left-top “S” means SUPERVISOR, and “1”, “2”, “3”,....., “8” mean USERS. The maximum length of NAME and PASSWORD is eight characters (A~Z and 0~9).

## ACCESS LIST

A C C E S S L I S T														X											
B	A	N	K	:	1				1	2	3	4	5	6	7	8									
0	1				●	S	Y	S	T	E	M		0	1	○	○	○	○	○	○	○	○	○	○	
0	2				●	S	Y	S	T	E	M		0	2	○	○	○	○	○	○	○	○	○	○	○
0	3				●	S	Y	S	T	E	M		0	3	○	○	○	○	○	○	○	○	○	○	○
0	4				●	S	Y	S	T	E	M		0	4	○	○	○	○	○	○	○	○	○	○	○
0	5				●	S	Y	S	T	E	M		0	5	○	○	○	○	○	○	○	○	○	○	○
0	6				●	S	Y	S	T	E	M		0	6	○	○	○	○	○	○	○	○	○	○	○
0	7				●	S	Y	S	T	E	M		0	7	○	○	○	○	○	○	○	○	○	○	○
0	8				●	S	Y	S	T	E	M		0	8	○	○	○	○	○	○	○	○	○	○	○
0	9				●	S	Y	S	T	E	M		0	9	○	○	○	○	○	○	○	○	○	○	○
1	0				●	S	Y	S	T	E	M		1	0	○	○	○	○	○	○	○	○	○	○	○
1	1				●	S	Y	S	T	E	M		1	1	○	○	○	○	○	○	○	○	○	○	○
1	2				●	S	Y	S	T	E	M		1	2	○	○	○	○	○	○	○	○	○	○	○
1	3				●	S	Y	S	T	E	M		1	3	○	○	○	○	○	○	○	○	○	○	○

Only SUPERVISOR can configure the ACCESS LIST. The first column is the port number, following the server/computer name list. The last 8 columns are the access right of each user. Use the **Enter** key or left button of mouse to active/deactivate the access right of each port. “X” means to disable access and “O” means to enable access.

## HOTKEY

H O T K E Y														X
E N T E R A C H O O S E :														
S c r o l l L o c k														
N u m b e r L o c k														
C a p s L o c k														
L e f t C t r l														
R i g h t C t r l														
L e f t A l t														
R i g h t A l t														
L e f t W i n														
R i g h t W i n														

Some keyboard may not equip with all the special keys. Make sure the key you select is available in your keyboard.

## TIME SETTINGS



When the Auto-Scan function is activated, the KVM switch will auto-scan the host ports one by one in the interval as setting. Notice that the port without connecting to a computer/server will be skipped over on the scan. The interval range is 5 ~ 99 seconds, and the default interval is 10 seconds. Press “**Enter**” key to save the SCAN TIME setting.

## OSD MOUSE



You can change the moving speed of mouse cursor in this item. There are three levels to choose from. The fastest moving speed is “FAST”, the second is “MIDDLE” and the slowest is “SLOW”.

Using "↑" and "↓" key on keyboard to move highlight bar to the wished speed. Press the **Enter** key to go into effect.

## FIRMWARE UPGRADE

Please follow the following procedures:

1. Power off the KVM switch.
2. Prepare the DC2.5M/DB9F cable, plug the DC2.5 end to the KVM switch's phone jack (marked Flash) and the DB9F end to PC serial DB9 port.
3. Power on the KVM unit. The KVM unit now will be in Flash mode, waiting for firmware download.
4. Run "**Firmware Upgrade Utility.exe**"

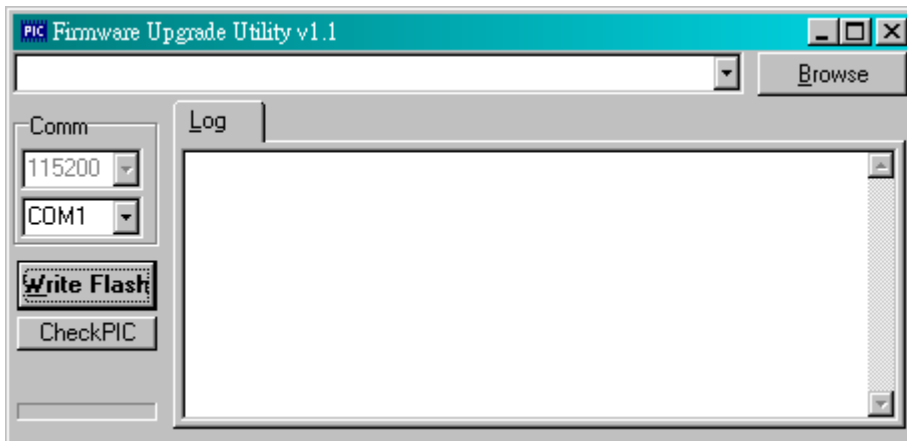

5. Click **Browse** to select the FW upgrade file. Please make sure you select the **correct FW upgrade file**.
6. Click **Write Flash** to start to upgrade. The upgrade process takes about 6 seconds, then display **WRITE OK** if complete the upgrade successfully.

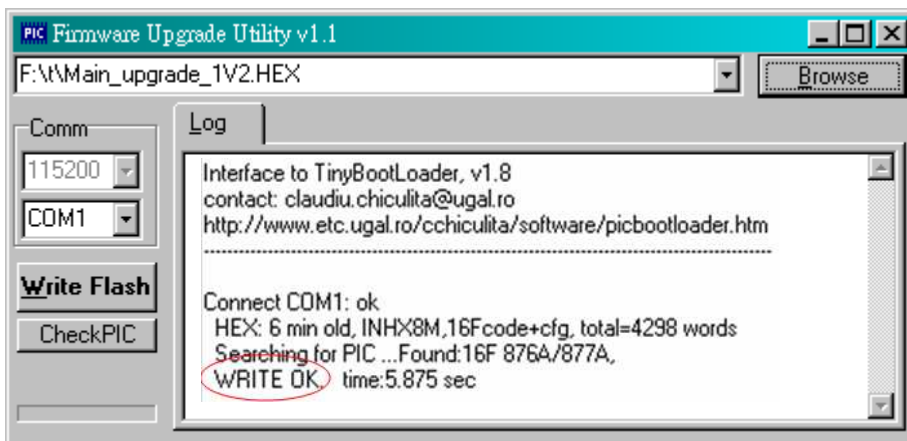

7. Disconnect the DC2.5M/DB9F cable from the KVM unit and PC. Now the KVM unit should be running on the new firmware. The FW version can be seen on the bottom-right corner of the PORT NAME OSD window.

## 6. Technical Specification

---

Model No.	KVM-0831	KVM-1631
PC Port	8	16
PC Port Connector (All Female Types)	VGA HDDB 15pin	
Local Console Port (All Female Types)	USB Keyboard (USB Type A) USB Mouse (USB Type A) VGA HDDB 15pin	
Remote Console Expansion Slot	ACC-1000 KVM Cat5 Console module (Optional)	
Daisy Chain Port Connector (All Female Type)	VGA HDDB 15pin	
PC selection	On Screen Display Menu, Hot Key, Push Button	
PC Port LED	8	16
Bank 7 segment LED	3	
On Screen Display	Yes	
Scan Intervals	5~99 Sec.	
Keyboard Emulation	PS2 or USB	
Mouse Emulation	PS2 or USB	
VGA Resolution	1920X1440	
Bandwidth	200MHz	
Daisy Chain MAX Level	8 levels	
MAX PC Connection	120*	128
Housing	Metal	
KVM Switch Power Adapter	DC 12V, 1.0A	
Operation Temperature	0~50°C	
Storage Temperature	-20 ~ 60°C	
Humidity	0~95%, Non-Condensing	
Weight (kg)	2.0kg	2.3kg
Dimension (mm)	445(L) X 160(W) X45 (H)	

\* Cascading 1 KVM-0831 + 7 KVM-1631 together

## 7. Troubleshooting

---

1. Ensure that all cables are well seated. Label all of cables with the number for each respective computer to avoid confusion.
2. Don't press any key on the keyboard while the selected computer is booting up. Otherwise, it might cause the keyboard error or keyboard is not detected at PC side.
3. If the keyboard or mouse does not work when connected to the KVM switch, please make sure the keyboard or mouse works when directly plug into the computer. If the problem persists, please try another keyboard or mouse.
4. If the mouse doesn't work in Auto Scan mode, you can press any key on the keyboard or the front button on the face plate for returning standard mode and then use the Keyboard or Mouse again.
5. If the Mouse is not detected during PC boot up, please make sure that the USB mouse works when directly plugged into the computer. Please avoid moving the mouse or pressing the mouse buttons when switching ports.
6. If you forget the password to access the KVM switch, please contact your supplier.
7. No video signal is displayed on the remote monitor:
  - A. Please check if the connectors of VGA cables and Cat.5 cables are loosed or disconnected. Notice that the VGA cable must be connected to computer during boot up process.
  - B. Please check if the power adapter is connected to extender.
8. If the video signal is foggy or un-cleared on the screen, please check if the VGA connector is well connected or the VGA resolution is too high for the length of cable being used. If the problem happened at VGA resolution, to shorten the Cat.5 cable length or reduce VGA resolution. It is highly recommended to use Cat.6 cable when the connection is longer than 150 meters.
9. The PS/2 keyboard or PS/2 mouse cable length is 30 meters maximum. The USB keyboard or USB mouse cable length is 5 meters maximum.