



Face Recognition Terminal

User Manual

User Manual

©2018 Hangzhou Hikvision Digital Technology Co., Ltd.

This manual is applied for face recognition terminal.

Series	Models
Face Recognition Terminal	DS-K1T604M
	DS-K1T604MF

Note: In the model, F represents the product contains fingerprint module. M represents the product supports swiping Mifare card.

It includes instructions on how to use the Product. The software embodied in the Product is governed by the user license agreement covering that Product.

About this Manual

This Manual is subject to domestic and international copyright protection. Hangzhou Hikvision Digital Technology Co., Ltd. (“Hikvision”) reserves all rights to this manual. This manual cannot be reproduced, changed, translated, or distributed, partially or wholly, by any means, without the prior written permission of Hikvision.

Trademarks

HIKVISION and other Hikvision marks are the property of Hikvision and are registered trademarks or the subject of applications for the same by Hikvision and/or its affiliates. Other trademarks mentioned in this manual are the properties of their respective owners. No right of license is given to use such trademarks without express permission.

Disclaimer

TO THE MAXIMUM EXTENT PERMITTED BY APPLICABLE LAW, HIKVISION MAKES NO WARRANTIES, EXPRESS OR IMPLIED, INCLUDING WITHOUT LIMITATION THE IMPLIED WARRANTIES OF MERCHANTABILITY AND FITNESS FOR A PARTICULAR PURPOSE, REGARDING THIS MANUAL. HIKVISION DOES NOT WARRANT, GUARANTEE, OR MAKE ANY REPRESENTATIONS REGARDING THE USE OF THE MANUAL, OR THE CORRECTNESS, ACCURACY, OR RELIABILITY OF INFORMATION CONTAINED HEREIN. YOUR USE OF THIS MANUAL AND ANY RELIANCE ON THIS MANUAL SHALL BE WHOLLY AT YOUR OWN RISK AND RESPONSIBILITY.

REGARDING TO THE PRODUCT WITH INTERNET ACCESS, THE USE OF PRODUCT SHALL BE WHOLLY AT YOUR OWN RISKS. OUR COMPANY SHALL NOT TAKE ANY RESPONSIBILITIES FOR ABNORMAL OPERATION, PRIVACY LEAKAGE OR OTHER DAMAGES RESULTING FROM CYBER ATTACK, HACKER ATTACK, VIRUS INSPECTION, OR OTHER INTERNET SECURITY RISKS; HOWEVER, OUR COMPANY WILL PROVIDE TIMELY TECHNICAL SUPPORT IF REQUIRED.

SURVEILLANCE LAWS VARY BY JURISDICTION. PLEASE CHECK ALL RELEVANT LAWS IN YOUR JURISDICTION BEFORE USING THIS PRODUCT IN ORDER TO ENSURE THAT YOUR USE CONFORMS THE APPLICABLE LAW. OUR COMPANY SHALL NOT BE LIABLE IN THE EVENT THAT THIS PRODUCT IS USED WITH ILLEGITIMATE PURPOSES.

IN THE EVENT OF ANY CONFLICTS BETWEEN THIS MANUAL AND THE APPLICABLE LAW, THE LATER PREVAILS.

Support

Should you have any questions, please do not hesitate to contact your local dealer.

Regulatory Information

FCC Information

Please take attention that changes or modification not expressly approved by the party responsible for compliance could void the user's authority to operate the equipment.

FCC compliance: This equipment has been tested and found to comply with the limits for a Class B digital device, pursuant to part 15 of the FCC Rules. These limits are designed to provide reasonable protection against harmful interference in a residential installation. This equipment generates, uses and can radiate radio frequency energy and, if not installed and used in accordance with the instructions, may cause harmful interference to radio communications. However, there is no guarantee that interference will not occur in a particular installation. If this equipment does cause harmful interference to radio or television reception, which can be determined by turning the equipment off and on, the user is encouraged to try to correct the interference by one or more of the following measures:

- Reorient or relocate the receiving antenna.
- Increase the separation between the equipment and receiver.
- Connect the equipment into an outlet on a circuit different from that to which the receiver is connected.
- Consult the dealer or an experienced radio/TV technician for help

FCC Conditions

This device complies with part 15 of the FCC Rules. Operation is subject to the following two conditions:

1. This device may not cause harmful interference.
2. This device must accept any interference received, including interference that may cause undesired operation.

EU Conformity Statement



This product and - if applicable - the supplied accessories too are marked with "CE" and comply therefore with the applicable harmonized European standards listed under the RE Directive 2014/53/EU, the EMC Directive 2014/30/EU, the RoHS

Directive 2011/65/EU



2012/19/EU (WEEE directive): Products marked with this symbol cannot be disposed of as unsorted municipal waste in the European Union. For proper recycling, return this product to your local supplier upon the purchase of equivalent new equipment, or dispose of it at designated collection points. For more information see:

www.recyclethis.info



2006/66/EC (battery directive): This product contains a battery that cannot be disposed of as unsorted municipal waste in the European Union. See the product

documentation for specific battery information. The battery is marked with this symbol, which may include lettering to indicate cadmium (Cd), lead (Pb), or mercury (Hg). For proper recycling, return the battery to your supplier or to a designated collection point. For more information see: www.recyclethis.info

This device is intended for mainly home use (Class B) and may be used in all areas.

B 급 기기: 이 기기는 가정용(B 급) 전자파적합기기로서 주로 가정에서 사용하는 것을 목적으로 하며, 모든 지역에서 사용할 수 있습니다.

Use only power supplies listed in the user instructions:

Model	Manufacturer
KPL-040F-VI	Channel Well Technology Co Ltd.



Safety Instruction

These instructions are intended to ensure that user can use the product correctly to avoid danger or property loss.

The precaution measure is divided into **Warnings** and **Cautions**:

Warnings: Neglecting any of the warnings may cause serious injury or death.

Cautions: Neglecting any of the cautions may cause injury or equipment damage.

	
Warnings Follow these safeguards to prevent serious injury or death.	Cautions Follow these precautions to prevent potential injury or material damage.



Warnings

- All the electronic operation should be strictly compliance with the electrical safety regulations, fire prevention regulations and other related regulations in your local region.
- Please use the power adapter, which is provided by normal company. The power consumption cannot be less than the required value.
- Do not connect several devices to one power adapter as adapter overload may cause over-heat or fire hazard.
- Please make sure that the power has been disconnected before you wire, install or dismantle the device.
- When the product is installed on wall or ceiling, the device shall be firmly fixed.
- If smoke, odors or noise rise from the device, turn off the power at once and unplug the power cable, and then please contact the service center.

- If the product does not work properly, please contact your dealer or the nearest service center. Never attempt to disassemble the device yourself. (We shall not assume any responsibility for problems caused by unauthorized repair or maintenance.)



Cautions

- Do not drop the device or subject it to physical shock, and do not expose it to high electromagnetic radiation. Avoid the equipment installation on vibrations surface or places subject to shock (ignorance can cause equipment damage).
- Do not place the device in extremely hot (refer to the specification of the device for the detailed operating temperature), cold, dusty or damp locations, and do not expose it to high electromagnetic radiation.
- The device cover for indoor use shall be kept from rain and moisture.
- Exposing the equipment to direct sun light, low ventilation or heat source such as heater or radiator is forbidden (ignorance can cause fire danger).
- Do not aim the device at the sun or extra bright places. A blooming or smear may occur otherwise (which is not a malfunction however), and affecting the endurance of sensor at the same time.
- Please use the provided glove when open up the device cover, avoid direct contact with the device cover, because the acidic sweat of the fingers may erode the surface coating of the device cover.
- Please use a soft and dry cloth when clean inside and outside surfaces of the device cover, do not use alkaline detergents.
- Please keep all wrappers after unpack them for future use. In case of any failure occurred, you need to return the device to the factory with the original wrapper. Transportation without the original wrapper may result in damage on the device and lead to additional costs.
- Improper use or replacement of the battery may result in hazard of explosion. Replace with the same or equivalent type only. Dispose of used batteries according to the instructions provided by the battery manufacturer.
- Biometric recognition products are not 100% applicable to anti-spoofing environments. If you require a higher security level, use multiple authentication modes.

Table of Contents

Chapter 1 Overview	1
1.1 Introduction	1
1.2 Main Features	1
Chapter 2 Appearance	3
Chapter 3 Installation	5
3.1 Installing with Gang Box	5
3.2 Installing without Gang Box	6
Chapter 4 Terminal Connection	9
Chapter 5 Basic Operation	11
5.1 Activate Device	11
5.1.1 Activating via Device	11
5.1.2 Activating via SADP Software	11
5.1.3 Activating via Client Software	13
5.2 Login	16
5.3 General Parameters Settings	16
5.3.1 Communication Settings	16
5.3.2 System Settings	18
5.3.3 Setting Time	23
5.4 User Management	24
5.4.1 Adding User	24
5.4.2 Managing User	28
5.5 Setting Access Control Parameters	29
5.6 Other Management	30
5.6.1 Managing Data	30
5.6.2 Managing Log Query	31
5.6.3 Importing/Exporting Data	32
5.6.4 Viewing System Information	34
5.7 Authenticating Identity	36
5.7.1 Authenticating via 1:1 Matching	36
5.7.2 Authenticating via 1:N Matching	37
5.7.3 Authenticating via 1:1 Matching and 1:N Matching	37
5.8 Two-way Audio	37
5.8.4 Calling iVMS-4200 Client Software from Device	38
5.8.5 Calling Device from iVMS-4200 Client Software	38

Chapter 6 Client Operation	40
6.1 User Registration and Login	40
6.2 System Configuration	41
6.3 Access Control Management	41
6.3.1 Adding Access Control Device	42
6.3.2 Viewing Device Status	57
6.3.3 Editing Basic Information	58
6.3.4 Network Settings	59
6.3.5 Capture Settings	61
6.3.6 RS-485 Settings	62
6.3.7 Wiegand Settings	63
6.3.8 Setting Multiple NICs	64
6.3.9 Setting Face Recognition Terminal	64
6.3.10 Remote Configuration	65
6.4 Organization Management	75
6.4.1 Adding Organization	75
6.4.2 Modifying and Deleting Organization	75
6.5 Person Management	76
6.5.1 Adding Person	76
6.5.2 Managing Person	87
6.5.3 Issuing Card in Batch	87
6.6 Schedule and Template	89
6.6.1 Week Schedule	90
6.6.2 Holiday Group	91
6.6.3 Template	92
6.7 Permission Configuration	94
6.7.1 Adding Permission	95
6.7.2 Applying Permission	96
6.8 Advanced Functions	97
6.8.1 Access Control Parameters	97
6.8.2 Card Reader Authentication	100
6.8.3 Multiple Authentication	102
6.8.4 Open Door with First Card	105
6.8.5 Anti-Passing Back	106
6.9 Searching Access Control Event	107
6.9.1 Searching Local Access Control Event	108

6.9.2	Searching Remote Access Control Event	108
6.10	Access Control Event Configuration	109
6.10.1	Access Control Event Linkage	109
6.10.2	Event Card Linkage	110
6.10.3	Cross-Device Linkage	112
6.11	Door Status Management	114
6.11.4	Access Control Group Management	114
6.11.5	Anti-control the Access Control Point (Door).....	115
6.11.6	Status Duration Configuration	117
6.11.7	Real-time Card Swiping Record	118
6.11.8	Real-time Access Control Alarm	119
6.12	Live View	121
6.12.1	Starting and Stopping Live View	121
6.12.2	Manual Recording and Capture	121
6.12.3	Other Functions in Live View	123
6.12.4	Controlling Door During Live View.....	124
6.13	Arming Control	125
6.14	Time and Attendance.....	125
6.14.1	Shift Schedule Management	126
6.14.2	Attendance Handling.....	132
6.14.3	Advanced Settings	136
6.14.4	Attendance Statistics.....	140
Appendix B Tips for Scanning Fingerprint		144
Appendix C Tips When Collecting/Comparing Face Picture.....		145
C.1 Positions (Recommended Distance:0.5m)		145
C.2 Expression		145
C.3 Posture.....		146
C.4 Size		146
Appendix D Tips for Installation Environment		147
Appendix E Dimension		148

Chapter 1 Overview

1.1 Introduction

DS-K1T604 series face recognition terminal is a kind of access control device for face recognition, which is mainly applied in security access control systems, such as logistic centers, airports, university campuses, alarm centrals, dwellings and so on.

1.2 Main Features

- 7-inch LCD touch screen with the screen ratio of 16:9 and the resolutions of 1024 × 600 pixel to display operation interface, view live video, etc.
 - 2,000,000 pixel wide-angle dual-lens
 - Adjusts supplement light brightness manually or automatically
 - QR code authentication
 - Face recognition distance: between 0.3 m and 1 m
 - Suggested height for face recognition: between 1.4 m and 1.9 m
 - Deep learning algorithm
 - Max. 10,000 face pictures storage
 - Multiple authentication modes:
Card, card and password, card or password, fingerprint, fingerprint and password, fingerprint or card, fingerprint and card, fingerprint and card and password, card or fingerprint or face or password, face and fingerprint, face and password, card and face, face, employee ID and password, fingerprint or password, employee ID and fingerprint, employee ID and fingerprint and password, card and fingerprint and face, face and fingerprint and password, employee ID and face, face and fingerprint and password, employee ID and face, face or fingerprint, card or face or password
- Note:** Only products with fingerprint module support the fingerprint scanning function.
- Face recognition duration ≤ 0.5s/User; face recognition accuracy rate ≥ 99%
 - Device parameters management, search, and settings
 - Imports card and user data to the device via TCP/IP communication or USB flash drive
 - Stand-alone operation
 - Transmits data (authentication results and captured pictures) to the client software via TCP/IP communication and saves the data on the client software
 - Capture linkage and captured pictures saving
 - Imports data (face pictures and face templates) to the device via the USB flash drive or from the client software

- Exports data (face pictures, events, and captured pictures) from the device via the USB flash drive
- Manage, search and set device data after logging the system backend
- Connects to one external card reader or access controller via RS-485 protocol
- Connects to external access controller or Wiegand card reader via Wiegand protocol
- Connects to secure door control unit via RS-485 protocol to avoid the door opening when the terminal is destroyed
- Two-way audio

Chapter 2 Appearance

Refer to the following contents for detailed information of the face recognition terminal:

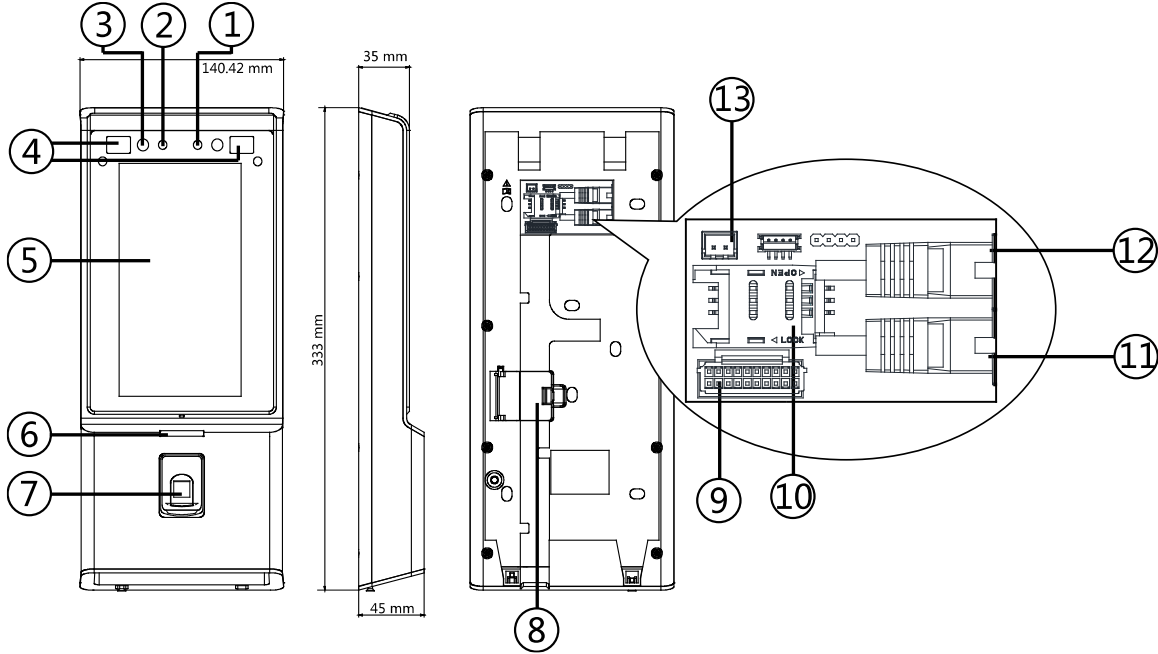

Table 2-1 Description of Face Recognition Terminal

No.	Name	Description
1	Camera (White Light)	White light camera for recording or capturing white light videos or pictures.
2	Camera (IR Light)	IR light camera for recording or capturing videos or pictures in IR light.
3	Supplement Light (IR Light)	Supplement light for IR camera.
4	Supplement Light (White Light)	Supplement light for white light camera.
5	Display Screen	7-inch LCD touch screen with the resolution of 1024 × 600.
6	Indicator	Solid Red: Standby.
		Flashing Red: Authentication failed.

		Solid Green: Authentication completed.
		Flashing Green: Authenticating (combined).
7	Fingerprint Module + Card Swiping Area	Scan fingerprint or swipe card. Note: Only the device with the fingerprint scanning function contains this part.
	Card Swiping Area	Swipe card within this area. Note: Only the device without the fingerprint scanning function contains this part.
8	PSAM Card Slot	Insert the PSAM card. The PSAM card is a card with Purchase Secure Access Module, which supports multiple secure accessing methods and permissions. It also supports communicating in a secure way.
9	Wiring Terminals	Connect to other external devices, including RS-485 card reader, Wiegand card reader, door lock, alarm input, alarm output, etc.
10	Micro SIM Card Slot	Insert SIM card.
11	Network Interface	Connect to Ethernet.
12	Network Interface	Connect to Ethernet.
13	Power Interface	Connect to power supply.

Chapter 3 Installation

Installation Environment:

- If installing the device indoors, the device should be at least 2 meters away from the light, and at least 3 meters away from the window or the door.
- Make sure the environment illumination is more than 100Lux.

Note: For details about installation environment, see *Appendix D Tips for Installation Environment*.

Installation Types: Wall mounting with gang box and wall mounting without gang box.

3.1 Installing with Gang Box

Steps:

1. According to the datum line on the mounting template, stick the mounting template on the wall or other surface, 1.3 meters higher than the ground.

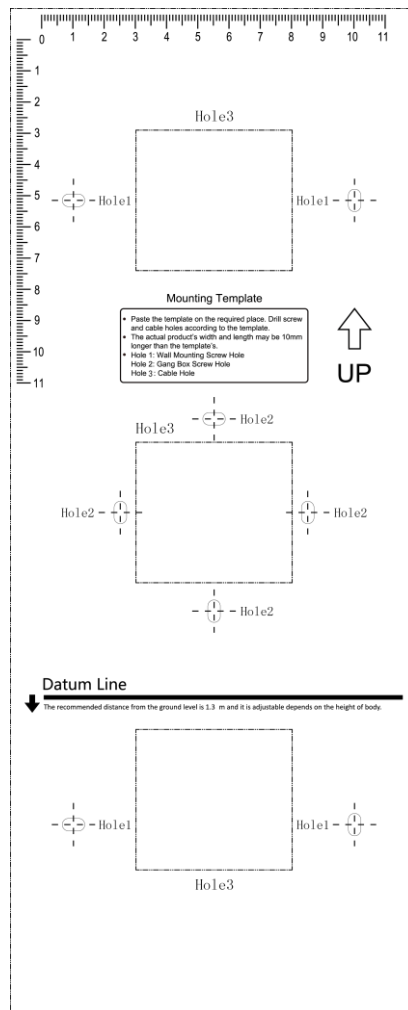

2. Drill holes on the wall or other surface according to the mounting template and install the gang box (80mm×80mm).
3. Use two supplied screws to secure the mounting plate on the gang box.
4. Use another four supplied screws to secure the mounting plate on the wall.
5. Remove the screw at the bottom of the device.
6. Align the terminal with the mounting plate and buckle them together.
7. Use a hex wrench to fasten the screw at the bottom.

Notes:

- The installation height here is the recommended height. You can change it according to your actual needs.
- For easy installation, drill holes on mounting surface according to the supplied mounting template.

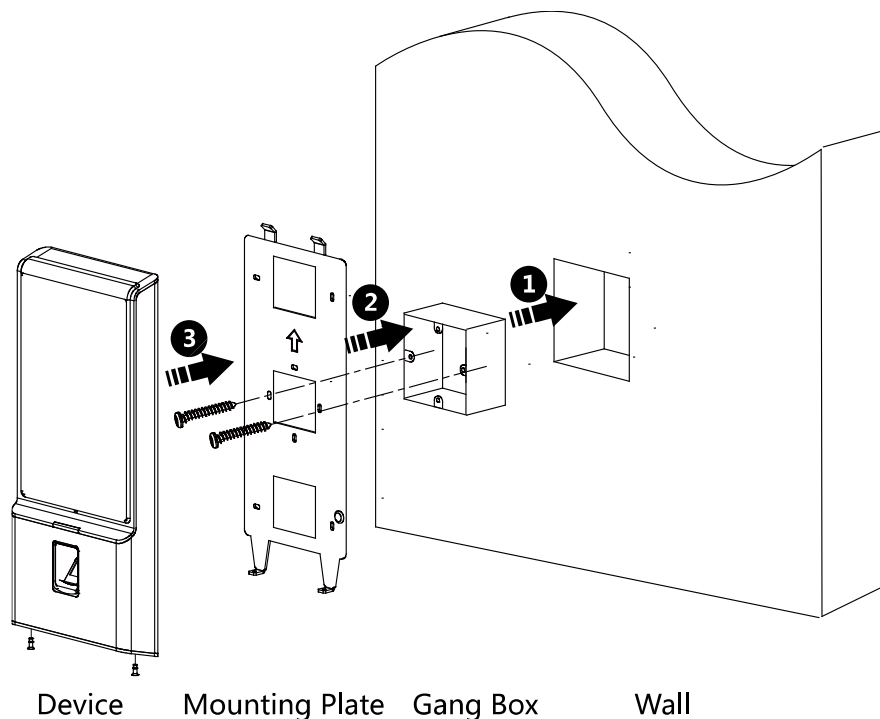

3.2 Installing without Gang Box

Steps:

1. According to the baseline on the mounting template, stick the mounting template on the wall or other surface, 1.3 meters higher than the ground.

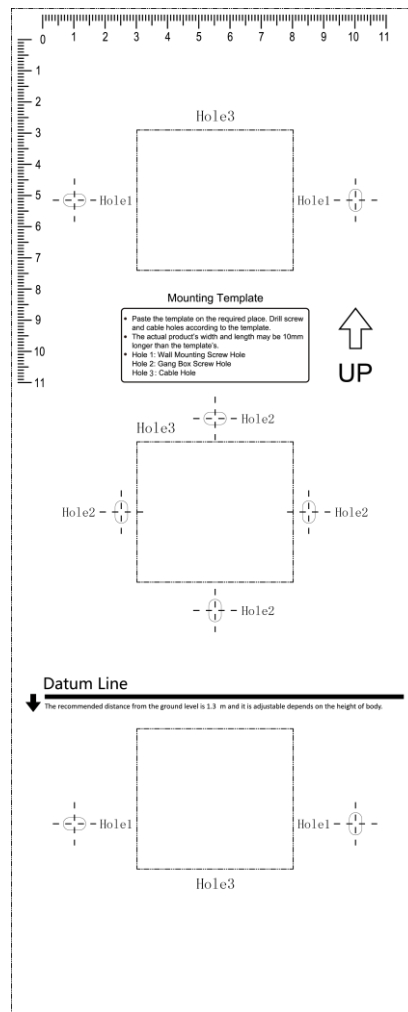

2. Drill 4 holes on the wall or other surface according to Hole 1 in the mounting template.
3. Insert the screw sockets of the setscrews in the drilled holes.

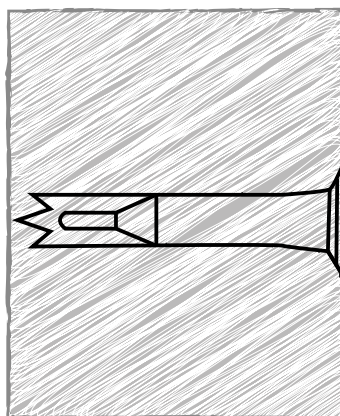

4. Align the 4 holes to the mounting plate with the drilled holes.
5. Fix and fasten the screws in the sockets on the wall or other surface.
6. Remove the two screws at the bottom of the device.
7. Align the terminal with the mounting plate and buckle them together.

8. Use a hex wrench to fasten the screw at the bottom.

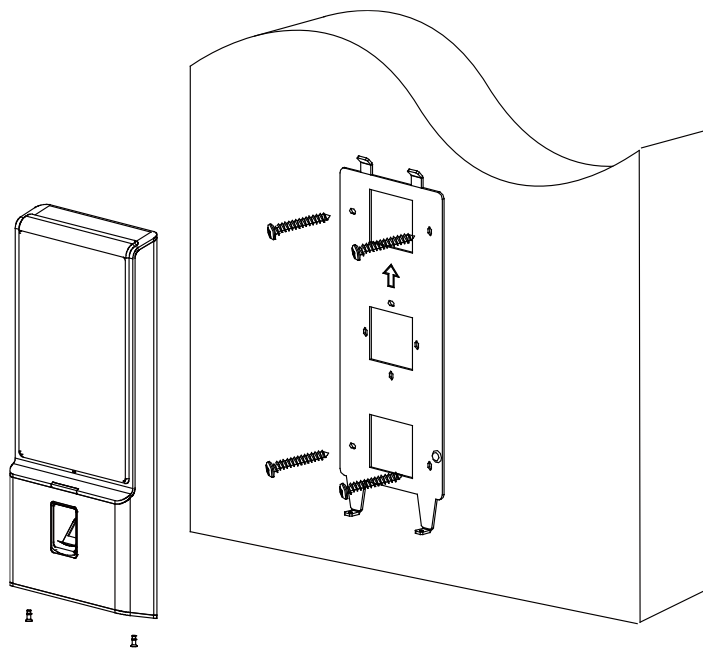

Chapter 4 Terminal Connection

You can connect the RS-485 terminal with the RS-485 card reader, connect the NC and COM terminals with the door lock, connect the SENSOR terminal with the door magnetic sensor, connect the BUTTON/GND terminal with the exit button, connect the alarm output and input terminal with the alarm output/input devices, and connect the Wiegand terminal with the Wiegand card reader or the access controller.

If you connect the WIEGAND terminal with the access controller, the face recognition terminal can transmit the authentication information to the access controller and the access controller can judge whether to open the door or not.

Notes:

- If you use 1.0 mm cables, you should use a 12V switched-mode power supply. And the distance between the power supply and the device should be no more than 20 m.
- If you use 1.5 mm cables, you should use a 12V switched-mode power supply. And the distance between the power supply and the device should be no more than 30 m.
- If you use 2.0 mm cables, you should use a 12V switched-mode power supply. And the distance between the power supply and the device should be no more than 40 m.

The wiring diagram is as follows:

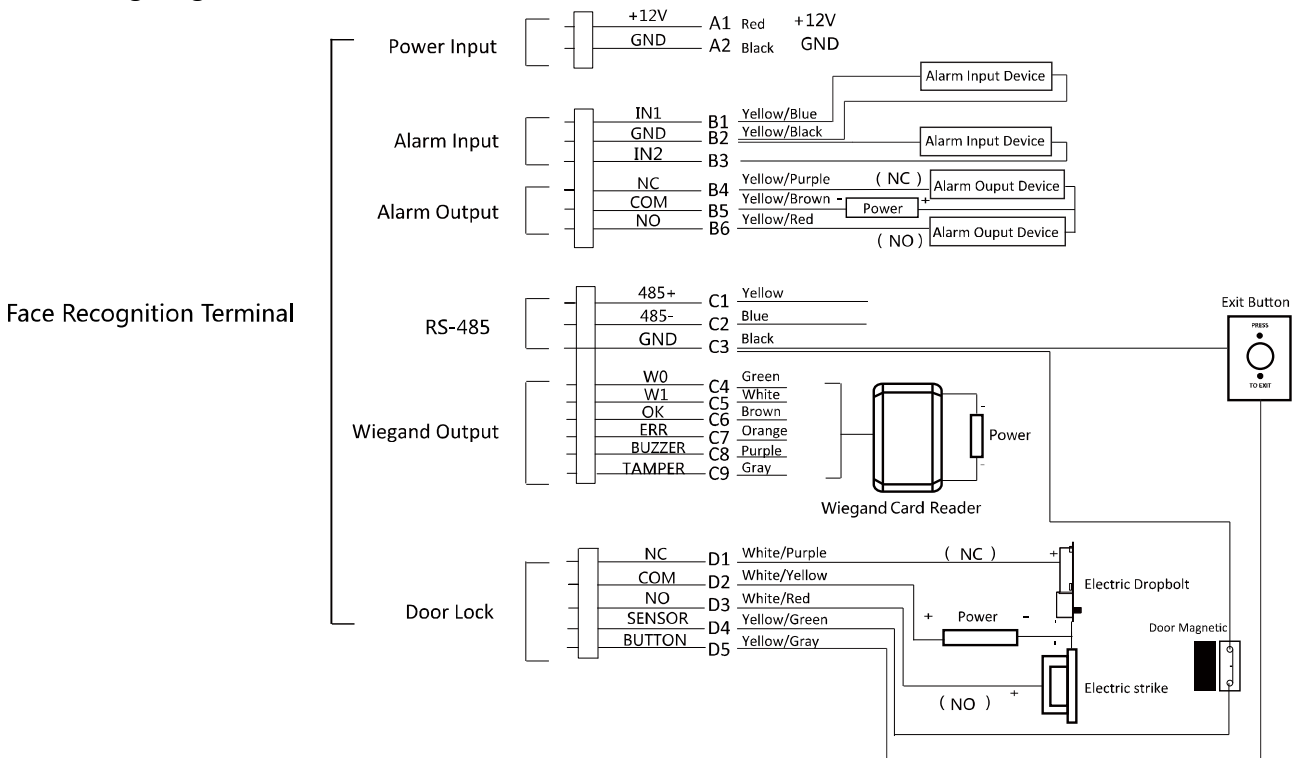

You can also connect the terminal with the secure door control unit. The wiring diagram is as follows:

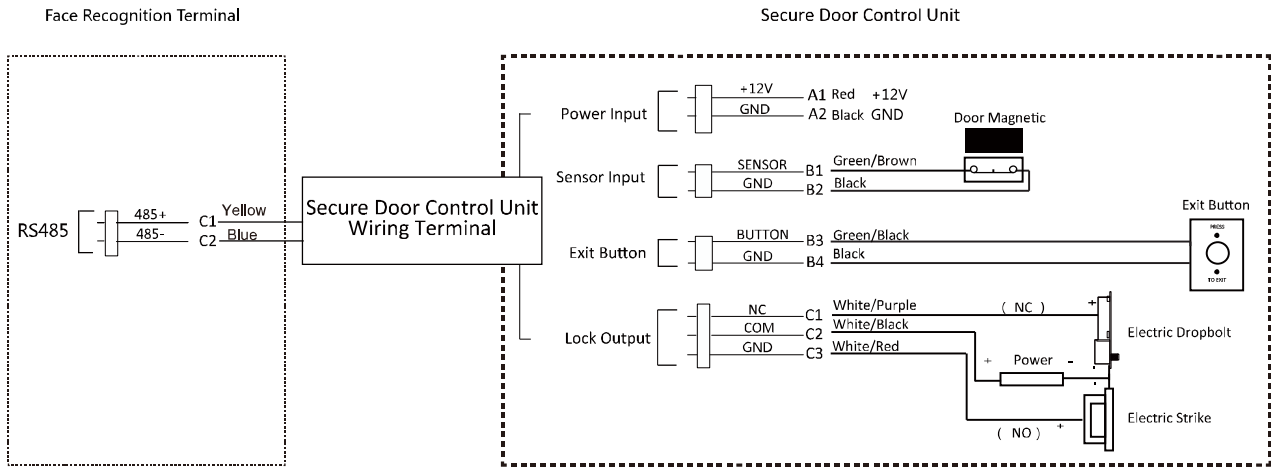

Note: The secure door control unit should connect to an external power supply separately.

Chapter 5 Basic Operation

5.1 Activate Device

Purpose:

You are required to activate the terminal first before using it.

Activation via device, activation via SADP, and activation via client software are supported.

The default values of the control terminal are as follows.

- The default IP address: 192.0.0.64.
- The default port No.: 8000.
- The default user name: admin.

5.1.1 Activating via Device

If the device is not activated, you can activate the device after it is powered on.

Steps:

1. Tap the Password field and create a password.
2. Tap the Confirm field and input the password again.
3. Tap **Activate** and the device will be activated.



STRONG PASSWORD RECOMMENDED– *We highly recommend you create a strong password of your own choosing (using a minimum of 8 characters, including upper case letters, lower case letters, numbers, and special characters) in order to increase the security of your product. And we recommend you reset your password regularly, especially in the high security system, resetting the password monthly or weekly can better protect your product.*

5.1.2 Activating via SADP Software

Purpose:

SADP software is used for detecting the online device, activating the device, and resetting the password.

Get the SADP software from the supplied disk or the official website, and install the SADP according to the prompts. Follow the steps to activate the device.

Steps:

1. Run the SADP software to search the online devices.
2. Check the device status from the device list, and select an inactive device.

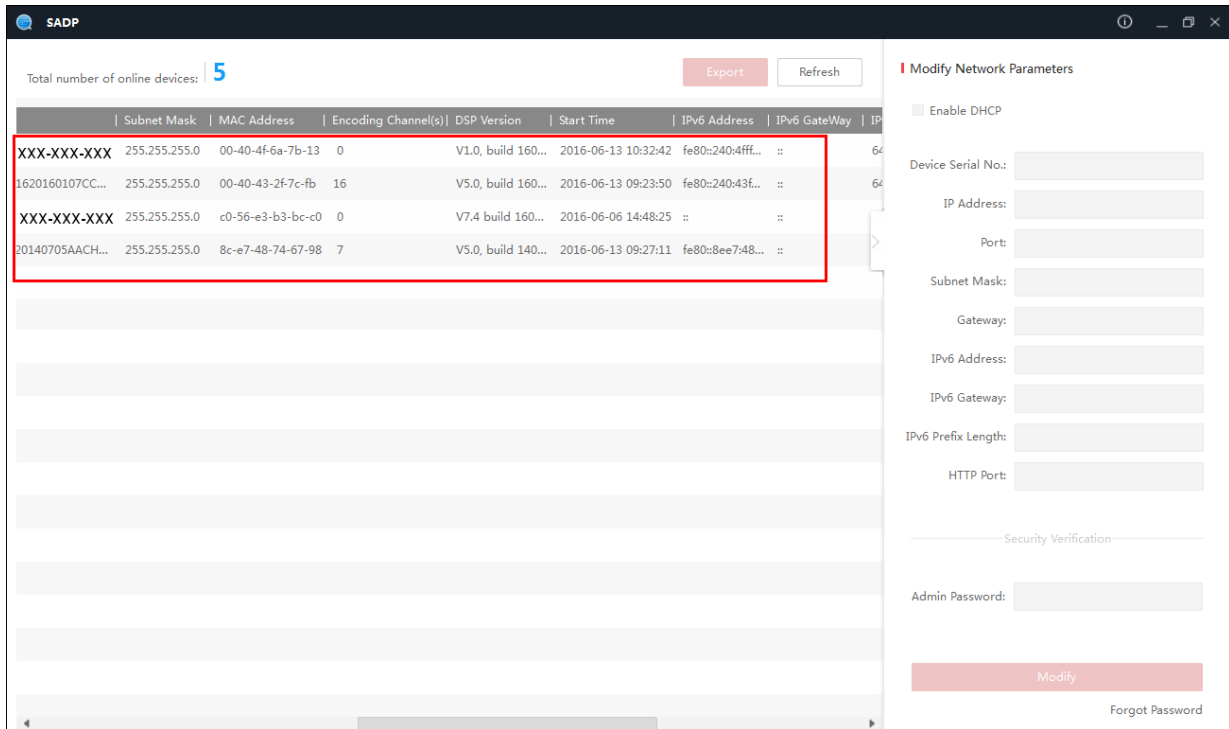

3. Create a password in the password field, and confirm the password.



STRONG PASSWORD RECOMMENDED— *We highly recommend you create a strong password of your own choosing (using a minimum of 8 characters, including upper case letters, lower case letters, numbers, and special characters) in order to increase the security of your product. And we recommend you reset your password regularly, especially in the high security system, resetting the password monthly or weekly can better protect your product.*

4. Click **Activate** to activate the device.

5. Check the activated device. You can change the device IP address to the same network segment with your computer by either editing the IP address manually or checking the Enable DHCP checkbox.

Modify Network Parameters

Enable DHCP

Device Serial No.:

IP Address:

Port:

Subnet Mask:

Gateway:

IPv6 Address:

IPv6 Gateway:

IPv6 Prefix Length:

HTTP Port:

Security Verification

Admin Password:

Modify

[Forgot Password](#)

6. Input the password and click **Modify** to save the IP address.

5.1.3 Activating via Client Software

Purpose:

The client software is versatile video management software for multiple kinds of devices.

Get the client software from the supplied disk or the official website, and install the software according to the prompts. Follow the steps to activate the control panel.

Steps:

1. Run the client software and the control panel of the software pops up, as shown in the figure below.

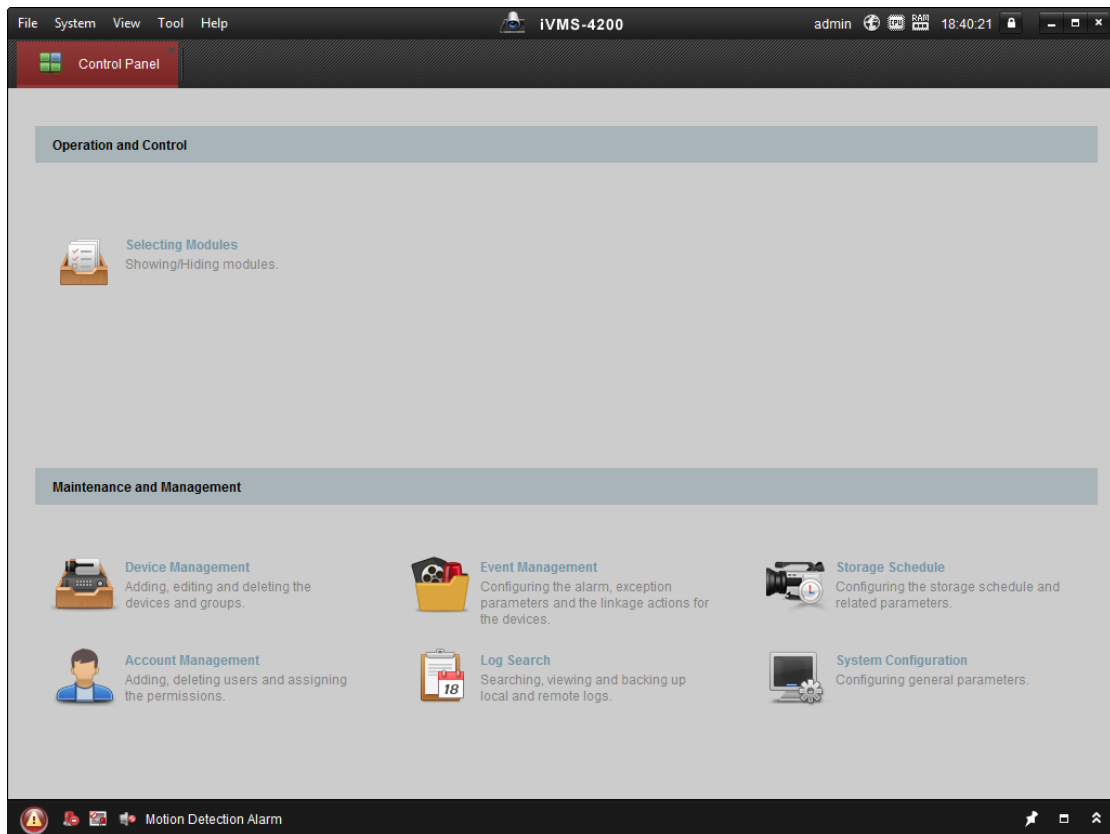

2. Click **Device Management** to enter the Device Management interface.
3. Check the device status from the device list, and select an inactive device.

IP	Device Type	Firmware Version	Security	Server Port	Device Serial No.	Start Time
192.0.0.64			Active	8000		2017-01
192.168.1.64			Inactive	8000		2017-01

4. Check the device status from the device list, and select an inactive device.
5. Click **Activate** to pop up the Activation interface.
6. In the pop-up window, create a password in the password field, and confirm the password.



STRONG PASSWORD RECOMMENDED— We highly recommend you create a strong password of your own choosing (using a minimum of 8 characters, including upper case letters, lower case letters, numbers, and special characters) in order to increase the security of your product. And we recommend you reset your password regularly, especially in the high security system, resetting the password monthly or weekly can better protect your product.



7. Click **OK** button to start activation.
8. Click the **Modify Netinfor** button to pop up the Network Parameter Modification interface.
9. Change the device IP address to the same network segment as your computer by modifying the IP address manually.
10. Input the password and click **OK** to save the settings.

After activation, you will enter the initial page:

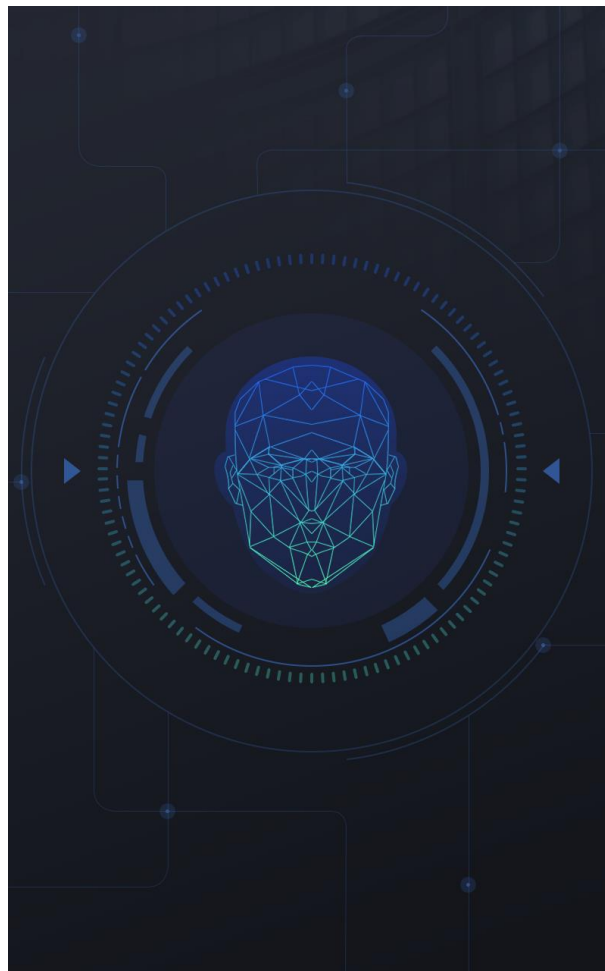

5.2 Login

You should enter the system backend first before setting the device parameters.

Steps:

1. Long tap the initial page for 3s to open the password inputting window.
2. Tap the Password field and input the device activation password.
Note: The password here is the activation password.
3. Tap **OK** to enter the home page.

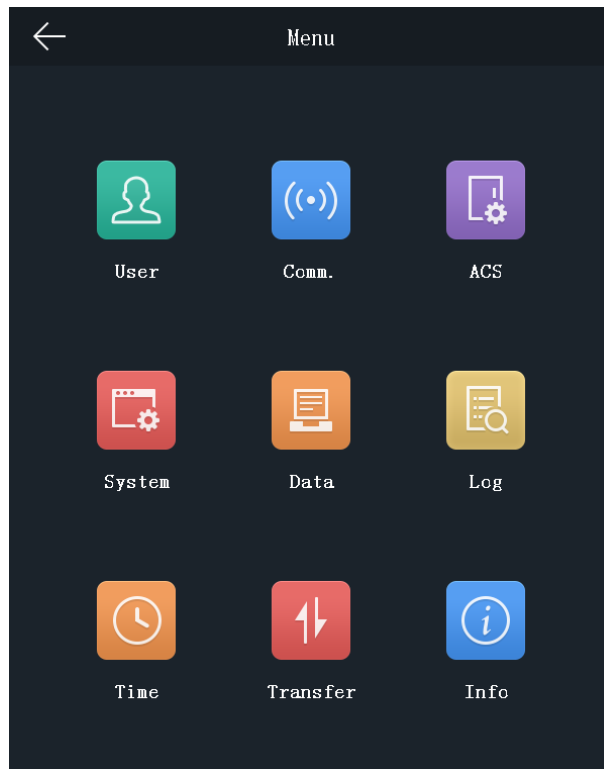

Notes:

- The device will be locked for 30 minutes after 5 failed password attempts.
- For details about setting the administrator authentication mode, see [5.4.1 Adding User](#).

5.3 General Parameters Settings

5.3.1 Communication Settings

Purpose:

You can set the network parameters, the RS-485 parameters, and the Wiegand parameters on the communication settings page.

Tap **Comm.** (Communication Settings) on the Home page to enter the Communication Settings page.

Setting Network Parameters

Purpose:

You can set the device network parameters, including the IP address, the subnet mask, and the gateway.

Steps:

1. On the Communication Settings page, tap **Network** to enter the Network tab.

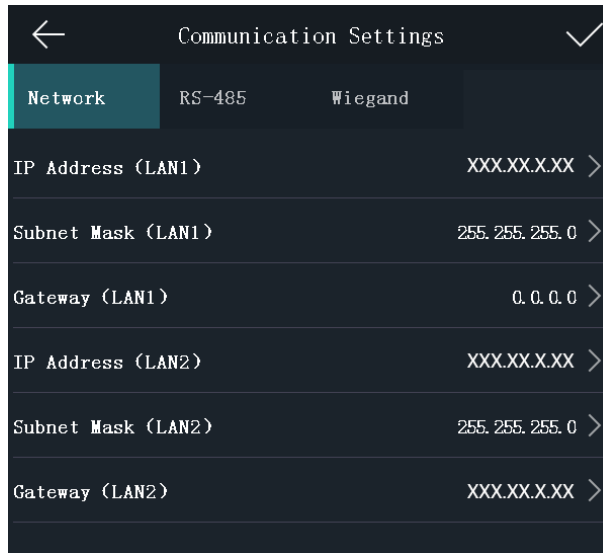

2. Configure the network parameters, including IP Address, Subnet Mask, and Gateway.

Notes:

- The device's IP address and the computer IP address should be in the same LAN.
- To avoid IP addresses confliction, the IP address of Network Interface 1 and 2 should be different if you want to apply both of them.

3. Tap ✓ to save the network parameters.

Setting RS-485 Parameters

Purpose:

The face recognition terminal can connect external access controller, secure door control unit or card reader via the RS-485 terminal.

Steps:

1. On the Communication Settings page, tap **RS-485** to enter the RS-485 tab.

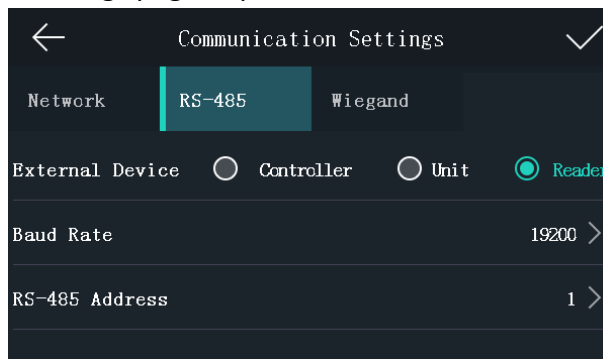

2. Select an external device according to your actual needs.

Note: Controller represents the access controller, Unit represents the secure door control unit and Reader represents the card reader.

3. Tap **Baud Rate** to enter the Baud Rate page.
4. Select a baud rate for connecting external device via RS-485 protocol.
5. In the Communication Settings page, select an RS-485 address.
6. Tap ✓ to save the RS-485 parameters and go back to the Home page.

Note: If you change the external device, and save the device parameters, the device will reboot automatically.

Setting Wiegand Parameters

Purpose:

You can set the Wiegand transmission direction.

Steps:

1. On the Communication Settings page, tap **Wiegand** to enter the Wiegand tab.

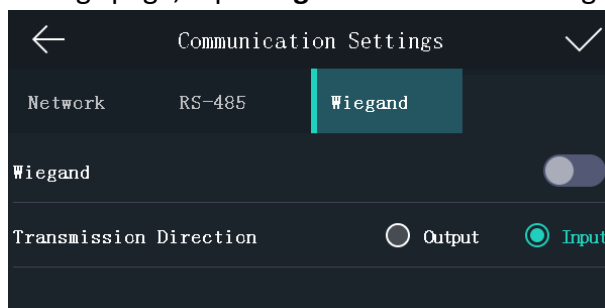

2. Tap the slider to enable the Wiegand function.
3. Select the transmission direction.

Transmission Direction:

- Output: A face recognition terminal can connect an external access controller. And the two devices will transmit the card No. via Wiegand 34.
- Input: A face recognition terminal can connect a Wiegand card reader.

4. Tap ✓ to save the Wiegand parameters and go back to the Home page.

5.3.2 System Settings

Purpose:

On the System Settings page, you can set the system basic parameters, the face parameters, the fingerprint parameters, and upgrade the firmware.



On the Home page, tap **System** (System Settings) to enter the System Settings page.

Setting Basic Parameters

Purpose:

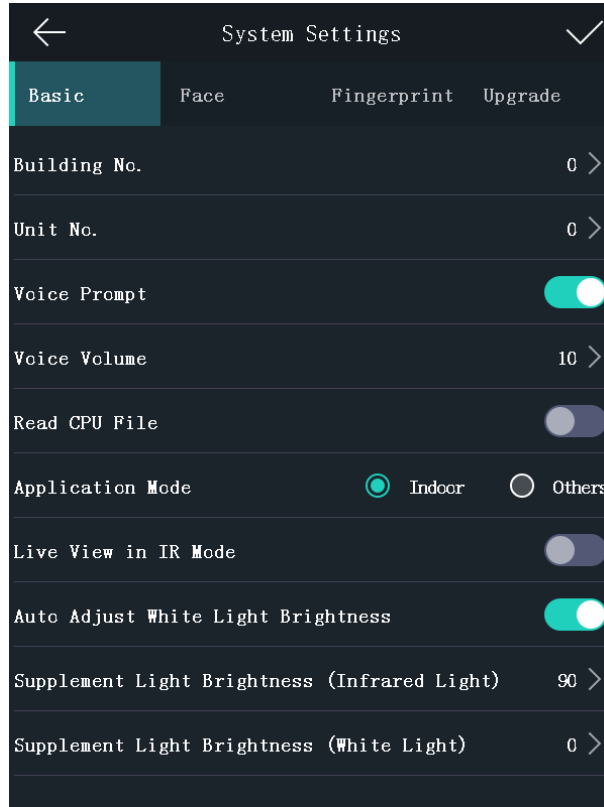
You can set the building No. and the unit No., voice prompt, voice volume, read CPU file, application mode, live view in IR mode, auto adjust white light brightness, supplement light brightness (Infrared Light), and supplement light brightness (white light).



Parameter	Description
Building No.	Set the device installed building No.
Unit No.	Set the device installed Unit No.
Voice Prompt	Tap  or  to disable or enable the voice prompt.
Voice Volume	Adjust the voice volume. The larger the value, the louder the volume.
Read CPU File	If the device supports swiping CPU card, you can enable the function and the device can read the CPU card information.
Application Mode	You can select either others or indoor according to actual environment.
Live View in IR Mode	The live view on the device screen will enter the IR mode.
Auto Adjust White Light Brightness	If enabling the function, the device will auto adjust the white light brightness according to the illumination. If disabling the function, the white light will turn on all the time and the brightness is the configured value of the supplement light brightness (white light).
Supplement Light Brightness (Infrared Light)	Set the IR light brightness when the IR light is enabled.
Supplement Light Brightness (White Light)	Set the supplement white light's brightness. The brightness ranges from 0 to 100. 0 refers to turning off the light. 1 refers to the darkest, and 100 refers to the brightest.

Setting Face Parameters

Purpose:

You can set the face 1:N match threshold, 1:1 match threshold, live face detection, liveness level, min. detection area (width), min. detection area (height), min. detection width (close to), margin (left), margin (top), margin (right), margin (bottom), pitch angle, yaw angle, pupillary distance, and score.



Parameter	Description
1:N Match Threshold	Set the matching threshold when authenticating via 1:N matching mode. The larger the value, the smaller the false accept rate and the larger the false rejection rate when authentication. By default, the value is 84.
1:1 Match Threshold	Set the matching threshold when authenticating via 1:1 matching mode. The larger the value, the smaller the false accept rate and the larger the false rejection rate when authentication. By default, the value is 75.

Parameter	Description
Live Face Detection	<p>Enable or disable the live face detection function. If enabling the function, the device can recognize whether the person is a live one or not.</p> <p>Note: Biometric recognition products are not 100% applicable to anti-spoofing environments. If you require a higher security level, use multiple authentication modes.</p>
Liveness Level (Liveness Security Level)	<p>After enabling Live Face Detection function, you can set the matching security level when performing live face authentication.</p>
Min. Detection Area (Width)	<p>When the distance between the camera and the user is long, the parameter represents the minimum percentage of the facial width in the total width of the recognition area. The actual percentage should be larger than the configured value when starting face authentication. Other percentages, distances and angles in this table should also meet their conditions.</p> <p>Recommended Value: 14</p>
Min. Detection Area (Height)	<p>When the distance between the camera and the user is long, the parameter represents the minimum percentage of the facial height in the total height of the recognition area. The actual percentage should be larger than the configured value when starting face authentication. Other percentages, distances and angles in this table should also meet their conditions.</p> <p>Recommended Value: 12</p>
Min. Detection Width (Close to)	<p>When the distance between the camera and the user is short, the parameter represents the minimum percentage of the facial width in the total width of the recognition area. The actual percentage should be larger than the configured value when starting face authentication. In this condition, the device will not detect other parameters.</p>
Margin (Left)	<p>The distance from the face left side to the left margin in the recognition area.</p> <p>The actual distance should be larger than the configured value when starting face authentication. Other percentages, distances, and angles should also meet their conditions.</p>
Margin (Top)	<p>The distance from the face top side to the top margin in the recognition area.</p> <p>The actual distance should be larger than the configured value when starting face authentication. Other percentages, distances, and angles should also meet their conditions.</p>
Margin (Right)	<p>The distance from the face right side to the right margin in the recognition area.</p>

Parameter	Description
	The actual distance should be larger than the configured value when starting face authentication. Other percentages, distances, and angles should also meet their conditions.
Margin (Bottom)	The distance from the face bottom side to the bottom margin in the recognition area. The actual distance should be larger than the configured value when starting face authentication. Other percentages, distances, and angles should also meet their conditions.
Pitch Angle	The maximum pitch angle when starting face authentication. By default, the angle is 30°.
Yaw Angle	The maximum yaw angle when starting face authentication. By default, the angle is 45°.
Pupillary Distance	The minimum resolution between two pupils when starting face recognition. The actual resolution should be larger than the configured value. By default, the resolution is 40.
Score	Set the face's score when recognition. The device will score the captured picture according to the yaw angle, pitch angle, and pupillary distance. If the score is less than the configured value, face recognition is failed.

Setting Fingerprint Parameters

Purpose:

You can set the fingerprint security level in this section.

Note: Only the device with the fingerprint scanning function supports the fingerprint related function.

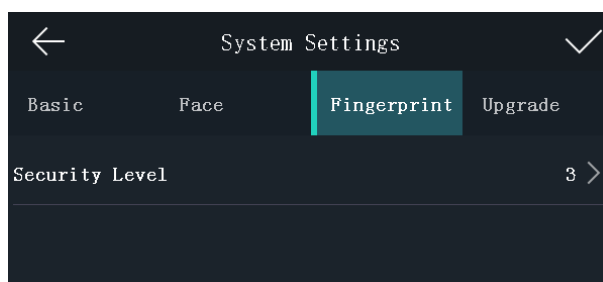

Parameter	Description
Security Level :	You can select the fingerprint security level. The higher is the security level, the lower is the false acceptance rate (FAR). The higher is the security level, the higher is the false rejection rate (FRR).

Upgrading Firmware

On the Upgrade page, plug in the USB flash drive and tap **Start**. The device will automatically read the upgrading file in the USB flash drive and upgrade the firmware.

Note:

- The upgrading file should be in the root directory.
- The upgrading file name should be digicap.dav.

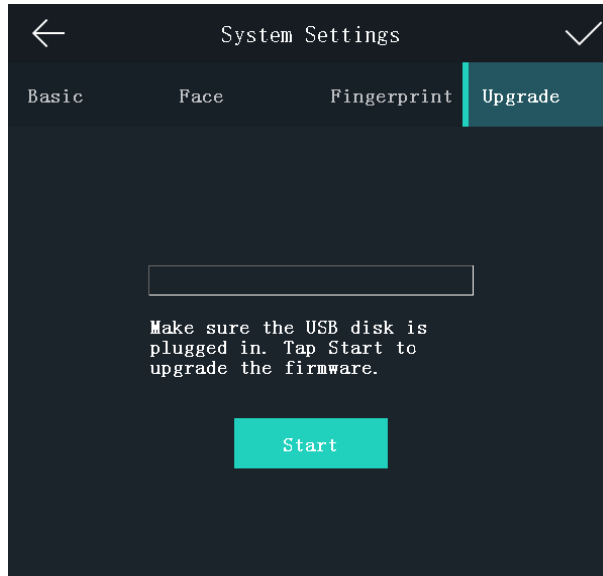

5.3.3 Setting Time

Purpose:

You can set the device time and the DST in this section.

Steps:

1. Tap **Time** (Time Settings) on the Home page to enter the Time Settings page.

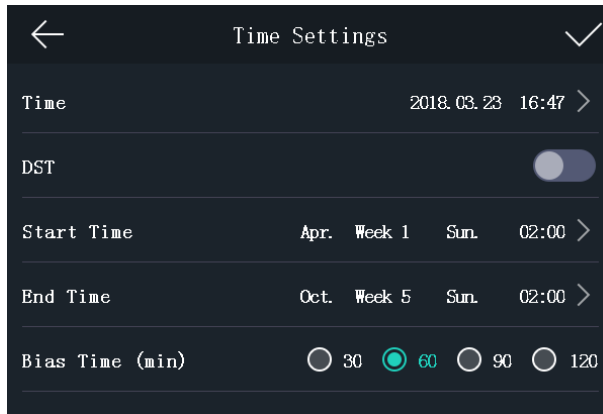

2. Edit the time parameters.

Parameter	Description
Time	Set the time which will be displayed on the device screen.
DST	Enable or disable the DST function. If enabling the DST function, you can set the DST start time, end time, and the bias time. Start Time: Set the DST start time. End Time: Set the DST end time.

	Bias Time: Set the DST bias time when the DST starts.
--	--

3. Tap to save the settings and go back to the Home page.

5.4 User Management

Purpose:

On the user management interface, you can add, edit, delete and search the user.

Tap **User** on the Home page to enter the User Management page.



5.4.1 Adding User

Purpose:

On the Add User page, you can add users, including the employee No., name, card No. You can also link the fingerprint, the face picture to the user, or set password, authentication mode, schedule template, administrator permission for the user.

Notes:

- Up to 50000 users can be added.
- The device with the model of DS-K1T604M does not support the fingerprint related function.

Steps:

1. On the User Management page, tap + to enter the Add User page.

2. Tap the **Employee ID.** field and edit the employee ID.

Notes:

The employee ID should be between 1 and 99999999. The employee ID should not start with 0 and should not be duplicated.

3. Tap the **Name** field and input the user name on the soft keyboard.

Notes:

- Numbers, upper case letters, lower case letters, and special characters are allowed in the user name.
- Up to 32 characters are allowed in the user name.

4. Tap the **Card** field and input the card No.

Option 1: Input the card No. manually.

Option2: Swipe the card over the card swiping area to get the card No.

Notes:

- The card No. cannot be empty.
- Up to 20 characters are allowed in the card No.
- By default, the card No. contains 10 characters. The system will use 0 to supplement the 10-character-card No. For example, 5 and 0000000005 are two different card No.
- The card No. cannot be duplicated.

5. Tap the **Password** field and create a password and confirm the password.

Note:

- Only numbers are allowed in the password.

- Up to 8 characters are allowed in the password.

6. Tap the **Fingerprint** field to enter the Add Fingerprint page.

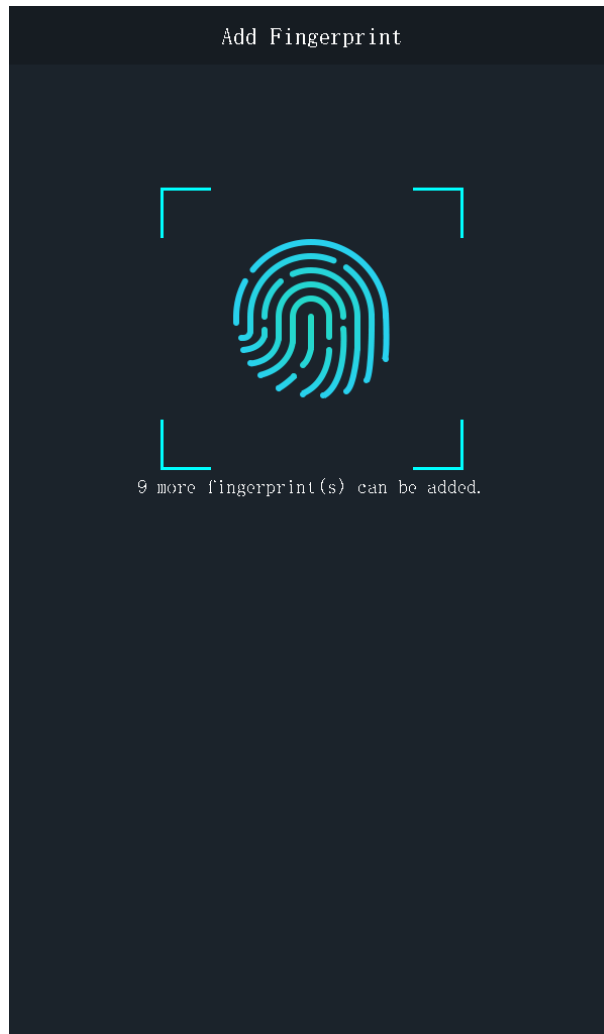

Follow the steps below to add fingerprint.

- 1) Place your finger on the fingerprint module.
- 2) Follow the instructions on the screen to record the fingerprint.
- 3) After adding the fingerprint completely, tap **Yes** in the pop-up dialog to save the fingerprint and continue to add another fingerprint.

Or tap **No** to save the fingerprint and go back to the Add User page.

Notes:

- The same fingerprint cannot be repeatedly added.
- Up to 10 fingerprints can be added for one user.
- You can also use the client software or the fingerprint recorder to record fingerprints.
- For details about the instructions of scanning fingerprints, see Appendix B Tips for Scanning Fingerprint.

7. Tap the **Face Picture** field to enter the face picture adding page.

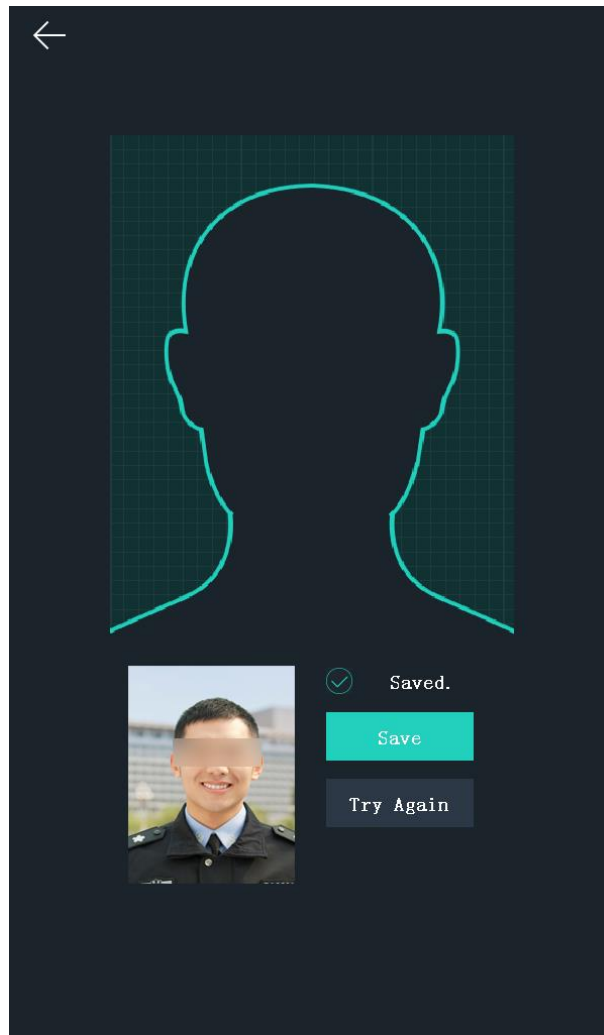

Follow the steps below to add the user's face picture.

1) Position your face looking at the camera.

Note: Make sure your face picture is in the face picture outline when adding the face picture.

After completely adding the face picture, a captured face picture will display on the page.

Notes:

- Make sure the captured face picture is in good quality and is accurate.
- For details about the instructions of adding face pictures, see *Appendix C Tips When Collecting/Comparing Face Picture*.

2) Tap **Save** to save the face picture.

Or tap **Try Again** and adjust your face position to add the face picture again.

Note: The maximum duration for adding a face picture is 15s. You can check the remaining time for adding a face picture on the left of the page.

8. Tap the **Schedule Template** field to enter the Schedule Template page. Select a schedule template and tap ✓ to save the settings.

Note: For details about setting the schedule template, see *6.6 Schedule and Template*. After applying the schedule template from the client software to the device, you can select the corresponding schedule template

9. Tap **Authentication Mode** to enter the Authentication Mode page. Select **Device** or **Custom** as the authentication mode.

Device: If you want to select device mode, you should set the terminal authentication mode in Access Control Settings page first. For details see *5.5 Setting Access Control Parameters*.

Custom: You can combine different authentication modes together according to your actual needs.

10. Enable or disable the **Duress Card** function.

When the function is enabled, the user's card will be the duress card. When the user authenticates by swiping this duress card, the device will upload an duress card event to the client software.

11. Tap ✓ to save the user parameters and go back to the Home page.

5.4.2 Managing User

Searching User

Purpose:

You can search the user in the list according to the employee ID, the card No., or the user name.

Steps:

1. On the User Management page, Tap  to enter the Search User page.

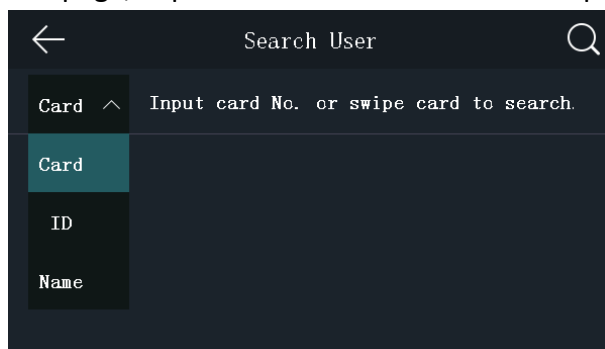

2. Tap **Card** on the left of the page and select a search type from the drop-down list.
3. Tap the input box and input the employee ID, the card No., or the user name for search.
4. Tap  to start search.

The searching result will be displayed in the list below.

Editing User

Purpose:

You can edit the added user information by following the steps in this section.

Steps:

1. In the User Management page, tap the user that needs to be edited to enter the Edit User

page.

2. Refer to the parameters' instructions in *Section 5.4.1 Adding User* to edit the user information.
3. Tap ✓ to save the settings and go back to the User Management page.

Note: The employee ID cannot be edited.

5.5 Setting Access Control Parameters

Purpose:

You can set the access control permissions, including the functions of authentication mode, door magnetic sensor, anti-passback, door locked time, door open timeout alarm, and max. failed authentications.

Steps:

1. On the Home page, tap **ACS** (Access Control Settings) to enter the Access Control Settings page.

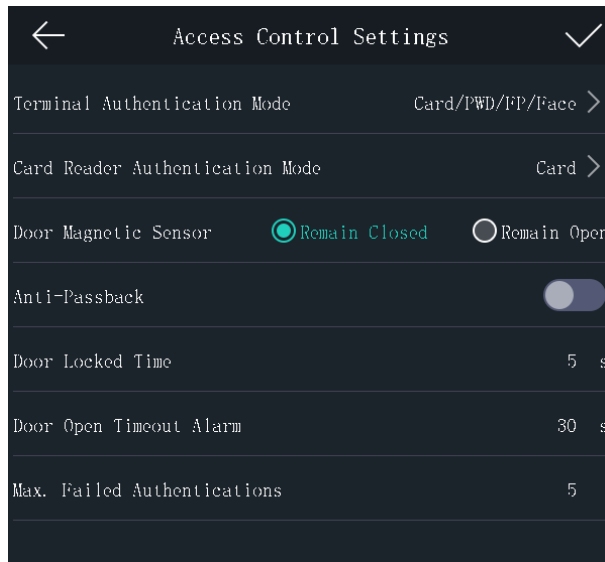

2. Edit the access control parameters.

The available parameters descriptions are as follows:

Parameter	Description
Terminal Authentication Mode	<p>Select the face recognition terminal's authentication mode. You can also customize the authentication mode.</p> <p>Notes:</p> <ul style="list-style-type: none"> ● Only the device with the fingerprint scanning function supports the fingerprint related function. ● Biometric recognition products are not 100% applicable to anti-spoofing environments. If you require a higher security level, use multiple authentication modes.
Card Reader Authentication Mode	Select the card reader's authentication mode.

Parameter	Description
Door Magnetic Sensor	You can select Remain Open or Remain Closed according to your actual needs. By default, it is Remain Closed.
Anti-Passback	When enabling the anti-passback function, you should set the anti-password path in the iVMS-4200 Client Software. The person should authenticate according to the configured path. Or the authentication will be failed.
Door Locked Time	Set the door unlocking duration. If the door is not opened for the set time, the door will be locked. Available door locked time range: 1 to 255s.
Door Open Timeout Alarm	The alarm can be triggered if the door has not been closed. Available range: 0 to 255s.
Max. Failed Authentications	Set the maximum authentication times. If you failed to authenticate for the set times, the alarm will be triggered.

3. Tap ✓ to save the settings.

5.6 Other Management

5.6.1 Managing Data

Purpose:

On the Data Management page, you can delete all events, delete user data, delete all data, clear permissions, delete captured pictures, restore to factory settings, or restore to default settings.

Steps:

1. Tap **Data** (Data Management) to enter the Data Management page.

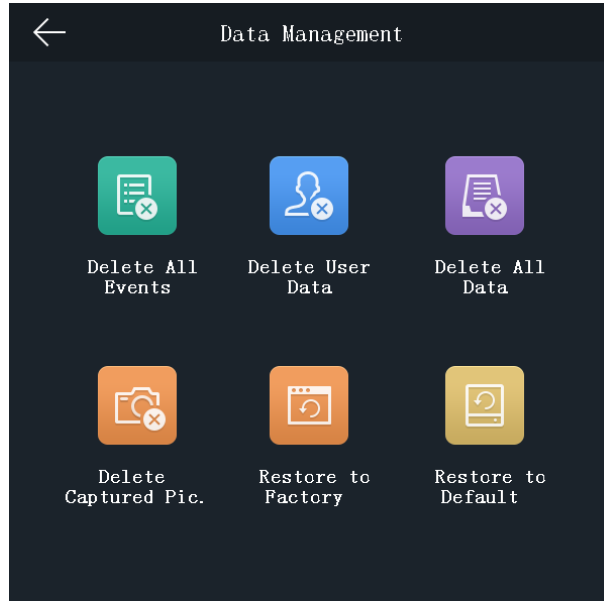

2. Tap the button on the page to manage data.
The available button descriptions are as follows:

Parameter	Description
Delete All Events	Delete all events stored in the device.
Delete User Data	Delete all user data in the device.
Delete All Data:	Delete all user data and events stored in the device.
Delete Captured Pic.	Delete the device captured pictured.
Restore to Factory	Restore the system to the factory settings. The device will reboot after the setting.
Restore to Default	Restore the system to the default settings. The system will save the communication settings and the remote user settings. Other parameters will be restored to default.

3. Tap **Yes** on the pop-up window to complete the settings.

5.6.2 Managing Log Query

Purpose:

You can search the authentication logs within a period of time by inputting employee ID, card No., or user name.

Steps:

1. On the Home page, tap **Log** (Log Query) to enter the Log Query page.

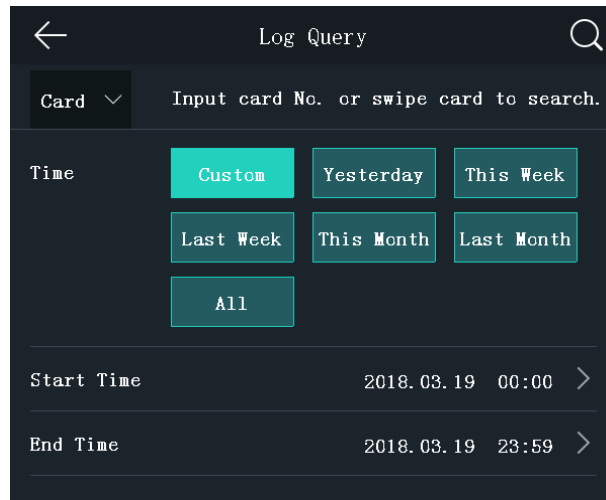

2. Tap **Card** on the left of the page and select a search type from the drop-down list.
3. Tap the input box and input the employee ID, the card No., or the user name for search.
4. Select time.
You can select from **Custom, Yesterday, This Week, Last Week, This Month, Last Month, or All**.
If you select **Custom**, you can customize the start time and the end time for search.
5. Tap  to start search.
The result will be displayed in the page.

5.6.3 Importing/Exporting Data

Purpose:

On the Transfer page, you can export the attendance data, the user data, the user picture, the access control parameter, and the captured picture to the USB flash drive. You can also import the user data, the user picture, and the access control parameter from the USB flash drive.

Tap **Transfer** on the Home page to enter the Transfer page.

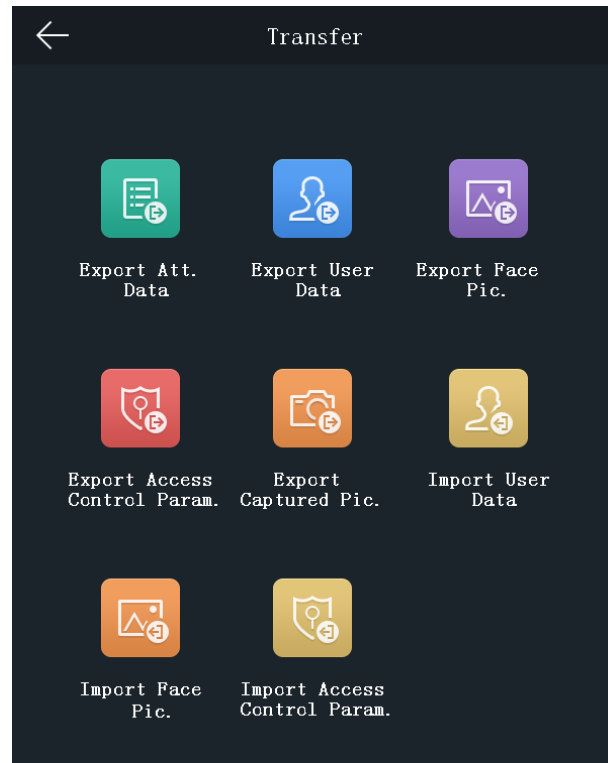

Exporting Data

Steps:

1. Plug a USB flash drive in the device.
2. On the Transfer page, tap **Export Att. Data**, **Export User Data**, **Export Face Pic.**, **Export Access Control Param.**, or **Export Captured Pic.**
3. Tap **Yes** on the pop-up page and the data will be exported from the device to the USB flash drive.

Notes:

- The supported USB flash drive format is FAT 32.
- The system supports the USB flash drive with the storage of 1G to 32G. Make sure the free space of the USB flash drive is more than 512M.
- The exported user data is a BIN file, which cannot be edited.

Importing Data

Steps:

1. Plug a USB flash drive in the device.
2. On the Transfer page, tap **Import User Data**, **Import Face Pic.**, or **Import Access Control Param.**
3. Tap **Yes** on the pop-up window and the data will be imported from the USB flash drive to the device.

Notes:

- If you want to transfer all user information from one device (Device A) to another (Device B), you should export the information from Device A to the USB flash drive and then import

from the USB flash drive to Device B. In this case, you should import the user data before importing the profile photo.

- The supported USB flash drive format is FAT 32.
- The imported picture should be saved in the root directory (enroll_pic) and the picture file's name should be follow the rule below:
Card No._Name_Department_Employee ID_Gender.jpg
- The employee ID should between 1 and 999999999, should not be duplicated, and should not start with 0.
- Requirements of face picture: It should be taken in full-face view directly facing the camera. Do not wear a hat or head covering when taking the face picture. The format should be JPEG or JPG. The resolution should be 640 × 480 pixel or more than of 640 × 480 pixel. The picture size should be between 60 KB and 200 KB.

5.6.4 Viewing System Information

Viewing Capacity

Purpose:

You can view the added user's number, the face picture's number, the card's number, the password's number, and the fingerprint's number.

Note: The device with the model of DS-K1T604M does not support displaying the fingerprint capacity.

Tap **Info.** (System Information) -> **Capacity** on the Home page to enter the Capacity page.

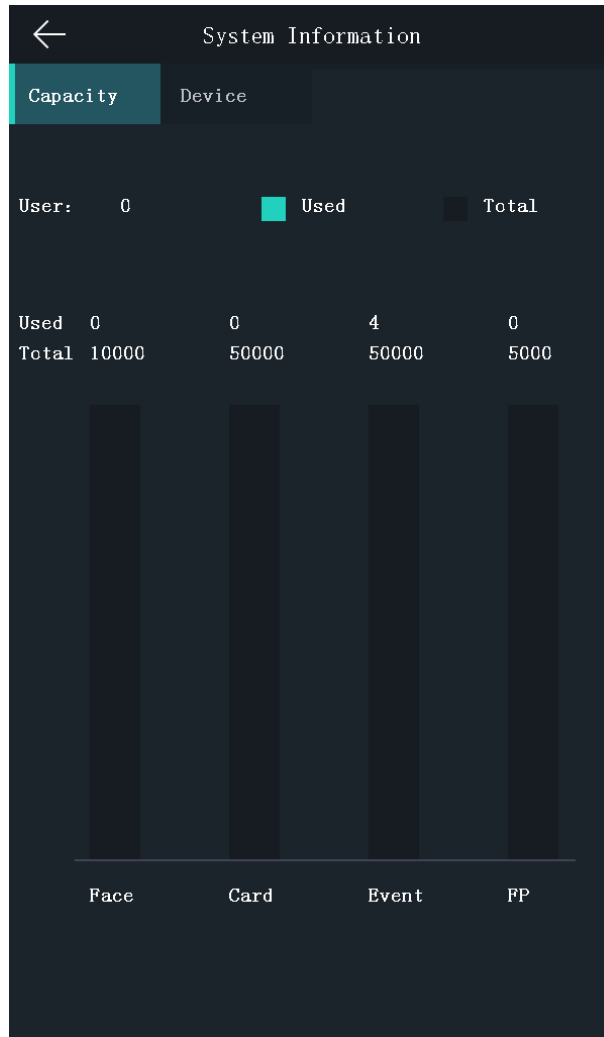

Viewing Device Information

Purpose:

You can view the device model, the serial No., the MAC address, the firmware version, the MCU version, and the production date.

Tap **Device** to enter the Device page.

Note: The device information page may vary according to different device models.

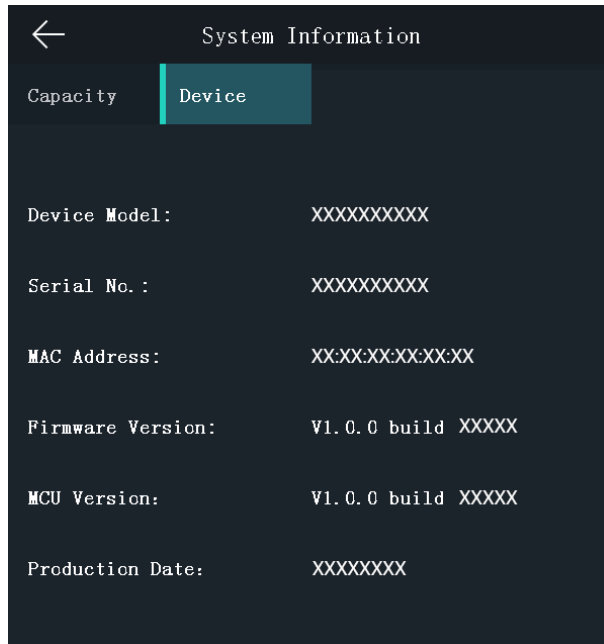

5.7 Authenticating Identity

Purpose:

After setting network, system parameters and adding user, you can go back to the initial page for identity authentication.

The system will authenticate person according to the configured authentication mode.

You can authenticate identity via 1:1 matching or 1:N matching.

Note: Biometric recognition products are not 100% applicable to anti-spoofing environments. If you require a higher security level, use multiple authentication modes.

1:N Matching: Compare the captured face picture or the collected fingerprint picture with all face pictures or all fingerprint pictures stored in the device.

1: 1 Matching: When swiping card, compare the captured face picture or the collected fingerprint with the information stored in the card.

5.7.1 Authenticating via 1:1 Matching

Steps:

1. If the authentication mode is Card and Face, Card and Face and Fingerprint, or Auto, swipe card in the card swiping area.

Note: The card can be normal IC card, or encrypted card.

If the QR Code Scanning function is enabled, you can put the QR code in front of the device camera to authenticate via QR code.

2. If the authentication mode is Card and Face, or Auto, position the face looking at the camera to authenticate face.

If the authentication mode is Card and Face and Fingerprint, after authenticating face completely, authenticate the fingerprint on the fingerprint module when the prompt “Continue to authenticate” will pop up.

If authentication succeeded, the prompt “Authenticated” will pop up.

Notes:

- For better face authentication, the user height should between 140 cm and 190 cm and the distance between the user and the device should be between 30 cm and 100 cm.
- For detailed information about scanning fingerprint, see *Appendix B Tips for Scanning Fingerprint*.
- For detailed information about authenticating face, see *Appendix C Tips When Collecting/Comparing Face Picture*.

5.7.2 Authenticating via 1:N Matching

If the authentication mode is Face or Auto, position the face looking at the camera to start face authentication.

If authentication completed, a prompt “Authenticated” will pop up.

5.7.3 Authenticating via 1:1 Matching and 1:N Matching

Steps:

1. If the authentication mode is Fingerprint and Face, authenticate fingerprint first according to the prompt on the device screen.
The device will compare the fingerprint with the fingerprint information in the device database (1:N Matching).
If authentication completed, a prompt “Continue to authenticate” will pop up.
2. Front the face looking at the camera to start face authentication.
The device will compare the captured face picture with the user information gained from the last step (1:1 Matching).
If authentication completed, a prompt “Authenticated” will pop up.

Notes:

- For better face authentication, the user height should between 140 cm and 190 cm and the distance between the user and the device should be between 30 cm and 100 cm.
- For detailed information about scanning fingerprint, see *Appendix B Tips for Scanning Fingerprint*.
- For detailed information about authenticating face, see *Appendix C Tips When Collecting/Comparing Face Picture*.

5.8 Two-way Audio

Purpose:

After adding the device to the iVMS-4200 client software, you can call the device from the client

software or call the client software from the device.

5.8.4 Calling iVMS-4200 Client Software from Device

Steps:

1. Get the client software from the supplied disk or the official website, and install the software according to the prompts.
2. Run the client software and the control panel of the software pops up.
3. Click **Device Management** to enter the Device Management interface.
4. Add the device to the client software.
Note: For details about adding device, see *6.3.1 Adding Access Control Device*.
5. Call the client software.
 - 1) Tap **Call** on the device initial page.
 - 2) Input **0** in the pop-up window.
 - 3) Tap **Call** to call the client software.
6. Tap **Answer** on the pop-up page of the client software and you can start two-way audio between the device and the client software.
Note: If the device is added by multiple client softwares and when the device is calling the client software, only the first client software added the device will pop up the call receiving window.

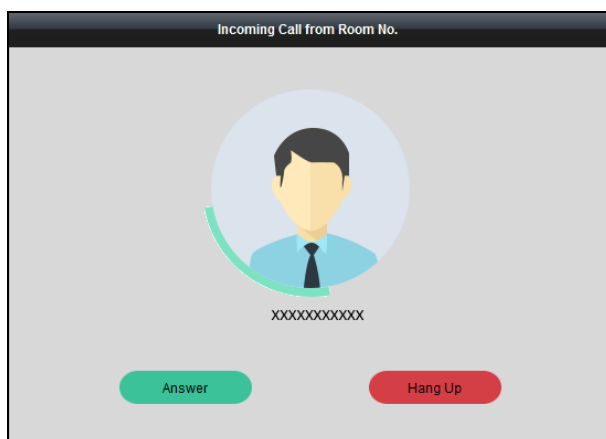

5.8.5 Calling Device from iVMS-4200 Client Software

Steps:

1. Get the client software from the supplied disk or the official website, and install the software according to the prompts.
2. Run the client software and the control panel of the software pops up.
3. Click **Device Management** to enter the Device Management interface.
4. Add the device to the client software.
Note: For details about adding device, see *6.3.1 Adding Access Control Device*.
5. Enter the Live View page and double-click the added device to start live view.
Note: For details about operations in the Live View page, see *6.12 Live View*.

6. Right click the live view image to open the right-click menu.
7. Click **Start Two-Way Audio** to start two-way audio between the device and the client software.

Chapter 6 Client Operation

You can set and operate the access control devices via the client software. This chapter will introduce the access control device related operations in the client software. For integrated operations, refer to *User Manual of iVMS-4200 Client Software*.

6.1 User Registration and Login

For the first time to use iVMS-4200 client software, you need to register a super user for login.

Steps:

1. Input the super user name and password. The software will judge password strength automatically, and we highly recommend you to use a strong password to ensure your data security.
2. Confirm the password.
3. Optionally, check the checkbox **Enable Auto-login** to log into the software automatically.
4. Click **Register**. Then, you can log into the software as the super user.

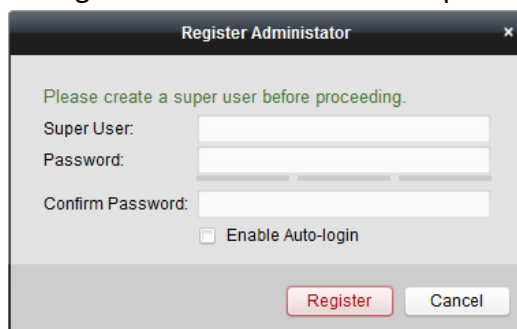

- ◆ A user name cannot contain any of the following characters: / \ : * ? " < > |. And the length of the password cannot be less than 6 characters.
- ◆ For your privacy, we strongly recommend changing the password to something of your own choosing (using a minimum of 8 characters, including upper case letters, lower case letters, numbers, and special characters) in order to increase the security of your product.
- ◆ Proper configuration of all passwords and other security settings is the responsibility of the installer and/or end-user.

When opening iVMS-4200 after registration, you can log into the client software with the registered user name and password.

Steps:

1. Input the user name and password you registered.
2. Optionally, check the checkbox **Enable Auto-login** to log into the software automatically.
3. Click **Login**.

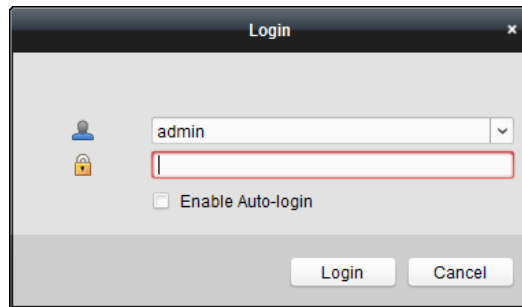

After running the client software, you can open the wizards (including video wizard, video wall wizard, security control panel wizard, access control and video intercom wizard, and attendance wizard), to guide you to add the device and do other settings and operations. For detailed configuration about the wizards, please refer to the *Quick Start Guide of iVMS-4200*.

6.2 System Configuration

Purpose:

You can synchronize the missed access control events to the client.

Steps:

1. Click **Tool – System Configuration**.
2. In the System Configuration window, check the **Auto-synchronize Access Control Event** checkbox.
3. Set the synchronization time.

The client will auto-synchronize the missed access control event to the client at the set time.

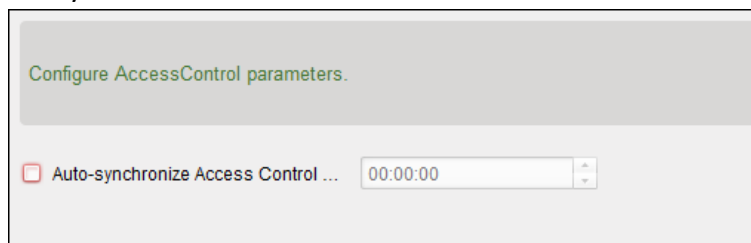

6.3 Access Control Management

Purpose:

The Access Control module is applicable to access control devices and video intercom. It provides multiple functionalities, including person and card management, permission configuration, access control status management, video intercom, and other advanced functions.

You can also set the event configuration for access control and display access control points and zones on E-map.

Note: For the user with access control module permissions, the user can enter the Access Control module and configure the access control settings.



Click  in the control panel, and check **Access Control** to add the Access Control module to the control panel.



Click to enter the Access Control module.

Person No.	Person Name	Organization	Gender	Card Quantity	Card No.	Fingerprint Qua...	Face Quantity	Operation
1	Lily	Group 1	Female	0		0	0	
2	Wendy	Group 1	Female	1	12345	0	0	

Before you start:

For the first time opening the Access Control module, the following dialog will pop up and you are required to select the scene according to the actual needs.

Non-residence: You can set the attendance rule when adding person, while set the access control parameters.

Residence: You cannot set the attendance rule when adding person.

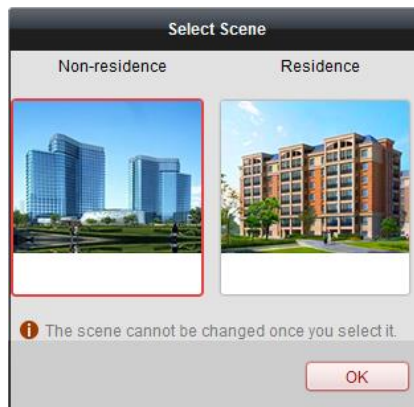

Note: Once the scene is configured, you cannot change it later.

6.3.1 Adding Access Control Device

Click in the Access Control module to enter the following interface.

Device Type	Nickname	Connection ...	Network Parameters	Device Serial No.
Access Controller	Access Controller	TCP/IP	10.18.146.86:8000	DS- [REDACTED] 6
Encoding Device	10.33.3.159	TCP/IP	10.33.3.159:8000	DS- [REDACTED] 3
Encoding Device	10.16.6.250	TCP/IP	10.16.6.250:8000	2014- [REDACTED]
Encoding Device	10.20.132.215	TCP/IP	10.20.132.215:8000	DS- [REDACTED] 7
Encoding Device	10.66.76.193	TCP/IP	10.66.76.193:8005	DS- [REDACTED] J
Indoor Station	Indoor Station	TCP/IP	10.16.6.104:8000	DS- [REDACTED] J
Security Control Panel	Security Control Pa...	TCP/IP	10.18.146.81:8000	DS- [REDACTED] U
Security Control Panel	10.16.6.92	TCP/IP	10.16.6.92:8000	DS- [REDACTED] 7

Note: After adding the device, you should check the device arming status in **Tool – Device Arming Control**. If the device is not armed, you should arm it, or you will not receive the real-time events via the client software. For details about device arming control, refer to *6.13 Arming Control*.

Creating Password

Purpose:

For some devices, you are required to create the password to activate them before they can be added to the software and work properly.

Note: This function should be supported by the device.

Steps:

1. Enter the Device Management page.
2. On the **Device for Management** or **Online Device** area, check the device status (shown on **Security** column) and select an inactive device.

IP	Device Type	Firmware Version	Security	Server Port	Device Serial No.	Start Time
192.0.0.64	[REDACTED]	[REDACTED]	Active	8000	[REDACTED]	2017-01
192.168.1.64	[REDACTED]	[REDACTED]	Inactive	8000	[REDACTED]	2017-01

3. Click the **Activate** button to pop up the Activation interface.
4. Create a password in the password field, and confirm the password.



STRONG PASSWORD RECOMMENDED– We highly recommend you create a strong password of your own choosing (using a minimum of 8 characters, including upper case letters, lower

case letters, numbers, and special characters) in order to increase the security of your product. And we recommend you reset your password regularly, especially in the high security system, resetting the password monthly or weekly can better protect your product.

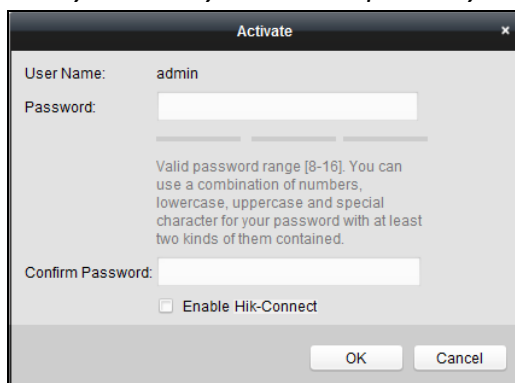

5. (Optional) Enable Hik-Connect service when activating the device if the device supports.
 - 1) Check **Enable Hik-Connect** checkbox to pop up the Note dialog.

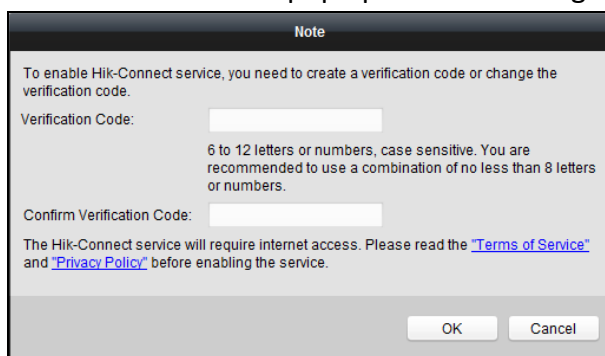

- 2) Create a verification code.
 - 3) Confirm the verification code.
 - 4) Click **Terms of Service** and **Privacy Policy** to read the requirements.
 - 5) Click **OK** to enable the Hik-Connect service.
6. Click **OK** to activate the device.

A "The device is activated." window pops up when the password is set successfully.
7. Click **Modify Netinfo** to pop up the Modify Network Parameter interface.

Note: This function is only available on the **Online Device** area. You can change the device IP address to the same subnet with your computer if you need to add the device to the software.
8. Change the device IP address to the same subnet with your computer by either modifying the IP address manually or checking the checkbox of DHCP.
9. Input the password set in step 4 and click **OK** to complete the network settings.

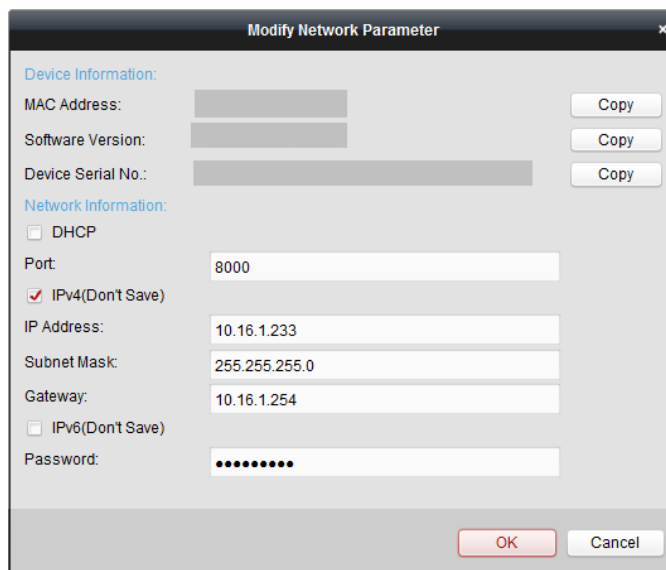

Adding Online Device

Purpose:

The active online devices in the same local subnet with the client software will be displayed on the **Online Device** area. You can click the **Refresh Every 60s** button to refresh the information of the online devices.

Note: You can click  to hide the **Online Device** area.

IP	Device Type	Firmware Version	Security	Server Port	Device Serial No.	Start Time
10.16.6.236	D		Active	8000		2017-01
10.16.6.92	D		Active	8000		2017-01
192.0.0.64	D		Active	8000		2017-01

Steps:

1. Select the devices to be added from the list.

Note: For the inactive device, you need to create the password for it before you can add the device properly. For detailed steps, please refer to *6.3.1 Adding Access Control Device*.

2. Click **Add to Client** to open the device adding dialog box.
3. Input the required information.

Nickname: Edit a name for the device as you want.

Address: Input the device’s IP address. The IP address of the device is obtained automatically in this adding mode.

Port: Input the device port No. The default value is *8000*.

User Name: Input the device user name. By default, the user name is *admin*.

Password: Input the device password.



STRONG PASSWORD RECOMMENDED– We highly recommend you create a strong password

of your own choosing (using a minimum of 8 characters, including upper case letters, lower case letters, numbers, and special characters) in order to increase the security of your product. And we recommend you reset your password regularly, especially in the high security system, resetting the password monthly or weekly can better protect your product.

4. Optionally, check the **Export to Group** checkbox to create a group by the device name. You can import all the channels of the device to the corresponding group by default.

Note: iVMS-4200 also provides a method to add the offline devices.

- 1) Check the **Add Offline Device** checkbox.
- 2) Input the required information, including the device channel number and alarm input number.
- 3) Click **Add**.

When the offline device comes online, the software will connect it automatically.

5. Click **Add** to add the device.

➤ Adding Multiple Online Device

If you want to add multiple online devices to the client software, click and hold *Ctrl* key to select multiple devices, and click **Add to Client** to open the device adding dialog box. In the pop-up message box, enter the user name and password for the devices to be added.

➤ Adding All Online Devices

If you want to add all the online devices to the client software, click **Add All** and click **OK** in the pop-up message box. Then enter the user name and password for the devices to be added.

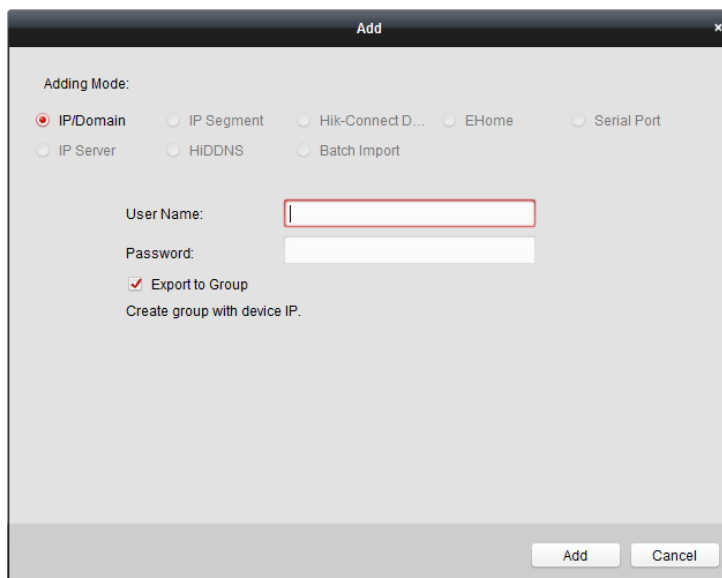

Adding Devices by IP or Domain Name

Steps:

1. Click **Add** to open the device adding dialog box.
2. Select **IP/Domain** as the adding mode.
3. Input the required information.

Nickname: Edit a name for the device as you want.

Address: Input the device's IP address or domain name.

Port: Input the device port No.. The default value is *8000*.

User Name: Input the device user name. By default, the user name is *admin*.

Password: Input the device password.



STRONG PASSWORD RECOMMENDED– *We highly recommend you create a strong password of your own choosing (using a minimum of 8 characters, including upper case letters, lower case letters, numbers, and special characters) in order to increase the security of your product. And we recommend you reset your password regularly, especially in the high security system, resetting the password monthly or weekly can better protect your product.*

4. Optionally, check the **Export to Group** checkbox to create a group by the device name. You can import all the channels of the device to the corresponding group by default.

Note: iVMS-4200 also provides a method to add the offline devices.

- 1) Check the **Add Offline Device** checkbox.
- 2) Input the required information, including the device channel number and alarm input number.
- 3) Click **Add**.

When the offline device comes online, the software will connect it automatically.

5. Click **Add** to add the device.

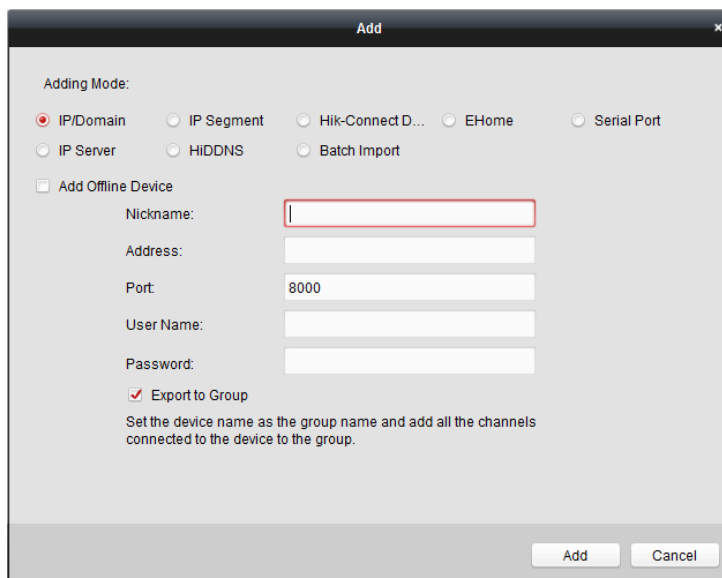

Adding Devices by IP Segment

Steps:

1. Click **Add** to open the device adding dialog box.
2. Select **IP Segment** as the adding mode.
3. Input the required information.

Start IP: Input a start IP address.

End IP: Input an end IP address in the same network segment with the start IP.

Port: Input the device port No.. The default value is *8000*.

User Name: Input the device user name. By default, the user name is *admin*.

Password: Input the device password.



STRONG PASSWORD RECOMMENDED– *We highly recommend you create a strong password of your own choosing (using a minimum of 8 characters, including upper case letters, lower case letters, numbers, and special characters) in order to increase the security of your product. And we recommend you reset your password regularly, especially in the high security system, resetting the password monthly or weekly can better protect your product.*

4. Optionally, check the **Export to Group** checkbox to create a group by the device name. You can import all the channels of the device to the corresponding group by default.

Note: iVMS-4200 also provides a method to add the offline devices.

- 1) Check the **Add Offline Device** checkbox.
- 2) Input the required information, including the device channel number and alarm input number.
- 3) Click **Add**.

When the offline device comes online, the software will connect it automatically.

5. Click **Add**.

You can add the device which the IP address is between the start IP and end IP to the device list.

Adding Devices by Hik-Connect Domain

Purpose:

You can add the devices connected via Hik-Connect by inputting the Hik-Connect account and password.

Before you start: Add the devices to Hik-Connect account via iVMS-4200, iVMS-4500 Mobile Client, or Hik-Connect first. For details about adding the devices to Hik-Connect account via iVMS-4200, refer to *the User Manual of iVMS-4200 Client Software*.

➤ Add Single Device

Steps:

1. Click **Add** to open the device adding dialog.
2. Select **Hik-Connect Domain** as the adding mode.
3. Select **Single Adding**.
4. Input the required information.

Nickname: Edit a name for the device as you want.

Device Serial No.: Input the device serial No.

User Name: Input the device user name. By default, the user name is *admin*.

Password: Input the device password.



STRONG PASSWORD RECOMMENDED– We highly recommend you create a strong password of your own choosing (using a minimum of 8 characters, including upper case letters, lower case letters, numbers, and special characters) in order to increase the security of your product. And we recommend you reset your password regularly, especially in the high security system, resetting the password monthly or weekly can better protect your product.

Hik-Connect Account: Input the Hik-Connect account.

Hik-Connect Password: Input the Hik-Connect password.

- Optionally, check the **Export to Group** checkbox to create a group by the device name. You can import all the channels of the device to the corresponding group by default.
- Click **Add** to add the device.

The screenshot shows a dialog box titled "Add". Under "Adding Mode:", there are radio buttons for "IP/Domain", "IP Segment", "Hik-Connect D..." (selected), "EHome", and "Serial Port". Below that, there are radio buttons for "IP Server", "HIDDNS", and "Batch Import". Under "Adding Mode:", there are radio buttons for "Batch Adding" and "Single Adding" (selected). There are input fields for "Nickname:", "Device Serial No.:", "User Name:", "Password:", "Hik-Connect Account:", and "Hik-Connect Password:". A checkbox labeled "Export to Group" is checked. Below the checkbox, there is a note: "Set the device name as the group name and add all the channels connected to the device to the group." At the bottom right, there are "Add" and "Cancel" buttons.

Add Devices in Batch

Steps:

- Click **Add** to open the device adding dialog.

The screenshot shows a dialog box titled "Add". Under "Adding Mode:", there are radio buttons for "IP/Domain", "IP Segment", "Hik-Connect D..." (selected), "EHome", and "Serial Port". Below that, there are radio buttons for "IP Server", "HIDDNS", and "Batch Import". Under "Adding Mode:", there are radio buttons for "Batch Adding" (selected) and "Single Adding". There are input fields for "Hik-Connect Account:" and "Hik-Connect Password:". A button labeled "Get Device List" is located below the password field. At the bottom right, there are "Add" and "Cancel" buttons.

- Select **Hik-Connect Domain** as the adding mode.
- Select **Batch Adding**.
- Input the required information.
Hik-Connect Account: Input the Hik-Connect account.
Hik-Connect Password: Input the Hik-Connect password.

- Click **Get Device List** to show the devices added to Hik-Connect account.

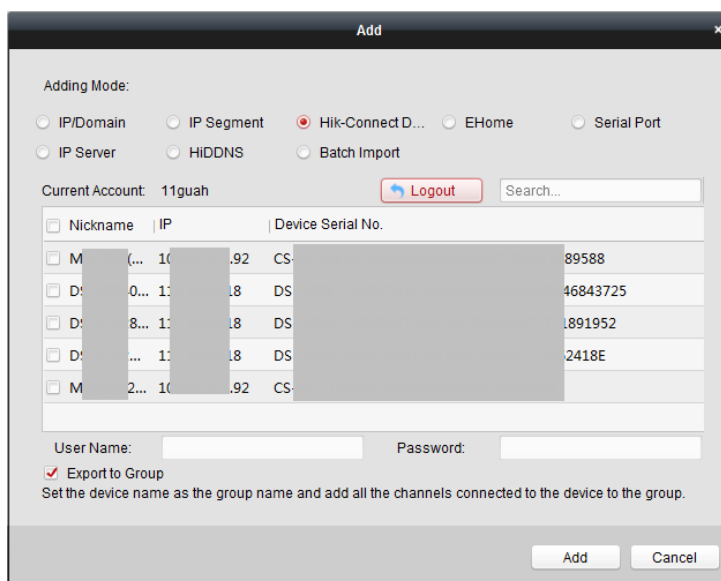

- Check the checkbox(es) to select the device as desired.
- Input the user name and password for the devices to be added.
- Optionally, check the **Export to Group** checkbox to create a group by the device name. You can import all the channels of the device to the corresponding group by default.
- Click **Add** to add the devices.

Adding Devices by EHome Account

Purpose:

You can add access control device connected via EHome protocol by inputting the EHome account.

Before you start: Set the network center parameter first. For details, refer to *Chapter 6.3.4 Network Settings*.

Steps:

- Click **Add** to open the device adding dialog box.
- Select **EHome** as the adding mode.

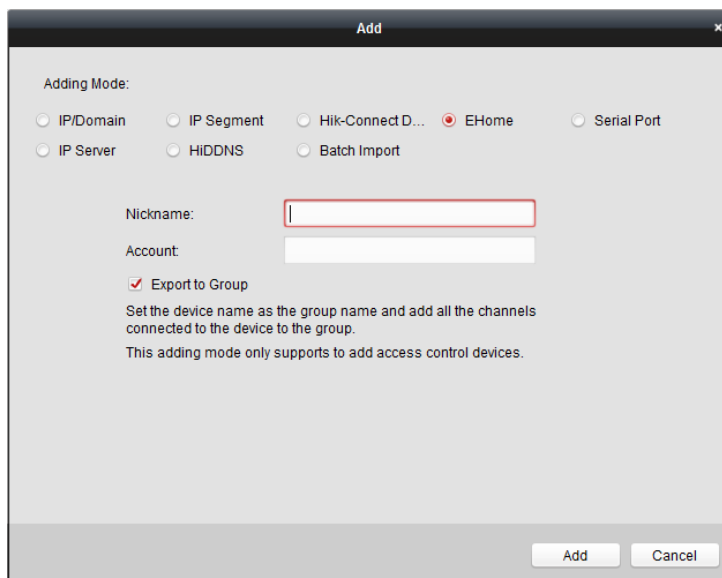

3. Input the required information.

Nickname: Edit a name for the device as you want.

Account: Input the account name registered on EHome protocol.

4. Optionally, check the **Export to Group** checkbox to create a group by the device name. You can import all the channels of the device to the corresponding group by default.

Note: iVMS-4200 also provides a method to add the offline devices.

1) Check the **Add Offline Device** checkbox.

2) Input the required information, including the device channel number and alarm input number.

3) Click **Add**.

When the offline device comes online, the software will connect it automatically.

5. Click **Add** to add the device.

Adding Devices by Serial Port

Purpose:

You can add access control device connected via serial port.

Steps:

1. Click **Add** to open the device adding dialog box.

2. Select **Serial Port** as the adding mode.

The screenshot shows a dialog box titled "Add" with a close button in the top right corner. The "Adding Mode:" section contains several radio button options: "IP/Domain", "IP Segment", "Hiik-Connect D...", "EHome", "Serial Port" (which is selected), "IP Server", "HiDDNS", and "Batch Import". Below this, there are four input fields: "Nickname" (an empty text box), "Serial Port No." (a dropdown menu showing "COM1"), "Baud Rate" (a text box showing "19200"), and "DIP" (a text box showing "1"). A checkbox labeled "Export to Group" is checked. At the bottom of the dialog, there is a note: "Set the device name as the group name and add all the channels connected to the device to the group. This adding mode only supports to add access control devices." In the bottom right corner, there are two buttons: "Add" and "Cancel".

3. Input the required information.
 - Nickname:** Edit a name for the device as you want.
 - Serial Port No.:** Select the device's connected serial port No.
 - Baud Rate:** Input the baud rate of the access control device.
 - DIP:** Input the DIP address of the device.
4. Optionally, check the **Export to Group** checkbox to create a group by the device name. You can import all the channels of the device to the corresponding group by default.
 - Note:** iVMS-4200 also provides a method to add the offline devices.
 - 1) Check the **Add Offline Device** checkbox.
 - 2) Input the required information, including the device channel number and alarm input number.
 - 3) Click **Add**.When the offline device comes online, the software will connect it automatically.
5. Click **Add** to add the device.

Adding Devices by IP Server

Steps:

1. Click **Add** to open the device adding dialog box.
2. Select **IP Server** as the adding mode.

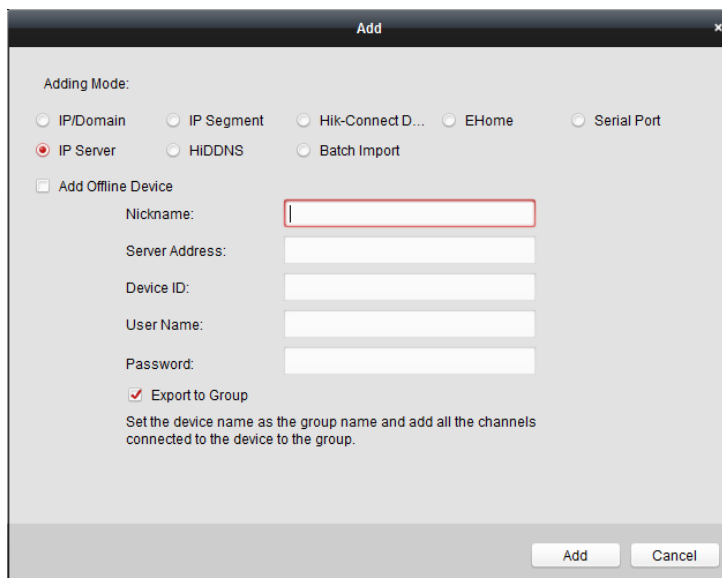

3. Input the required information.

Nickname: Edit a name for the device as you want.

Server Address: Input the IP address of the PC that installs the IP Server.

Device ID: Input the device ID registered on the IP Server.

User Name: Input the device user name. By default, the user name is *admin*.

Password: Input the device password.



STRONG PASSWORD RECOMMENDED– *We highly recommend you create a strong password of your own choosing (using a minimum of 8 characters, including upper case letters, lower case letters, numbers, and special characters) in order to increase the security of your product. And we recommend you reset your password regularly, especially in the high security system, resetting the password monthly or weekly can better protect your product.*

4. Optionally, check the **Export to Group** checkbox to create a group by the device name. You can import all the channels of the device to the corresponding group by default.

Note: iVMS-4200 also provides a method to add the offline devices.

1) Check the **Add Offline Device** checkbox.

2) Input the required information, including the device channel number and alarm input number.

3) Click **Add**.

When the offline device comes online, the software will connect it automatically.

5. Click **Add** to add the device.

Adding Devices by HiDDNS

Steps:

1. Click **Add** to open the device adding dialog box.

2. Select **HiDDNS** as the adding mode.

3. Input the required information.

Nickname: Edit a name for the device as you want.

Server Address: www.hik-online.com.

Device Domain Name: Input the device domain name registered on HiDDNS server.

User Name: Input the device user name. By default, the user name is *admin*.

Password: Input the device password.



STRONG PASSWORD RECOMMENDED– *We highly recommend you create a strong password of your own choosing (using a minimum of 8 characters, including upper case letters, lower case letters, numbers, and special characters) in order to increase the security of your product. And we recommend you reset your password regularly, especially in the high security system, resetting the password monthly or weekly can better protect your product.*

4. Optionally, check the **Export to Group** checkbox to create a group by the device name. You can import all the channels of the device to the corresponding group by default.

Note: iVMS-4200 also provides a method to add the offline devices.

1) Check the **Add Offline Device** checkbox.

2) Input the required information, including the device channel number and alarm input number.

3) Click **Add**.

When the offline device comes online, the software will connect it automatically.

5. Click **Add** to add the device.

Importing Devices in Batch

Purpose:

The devices can be added to the software in batch by inputting the device information in the pre-defined CSV file.

Steps:

1. Click **Add** to open the device adding dialog box.
2. Select **Batch Import** as the adding mode.

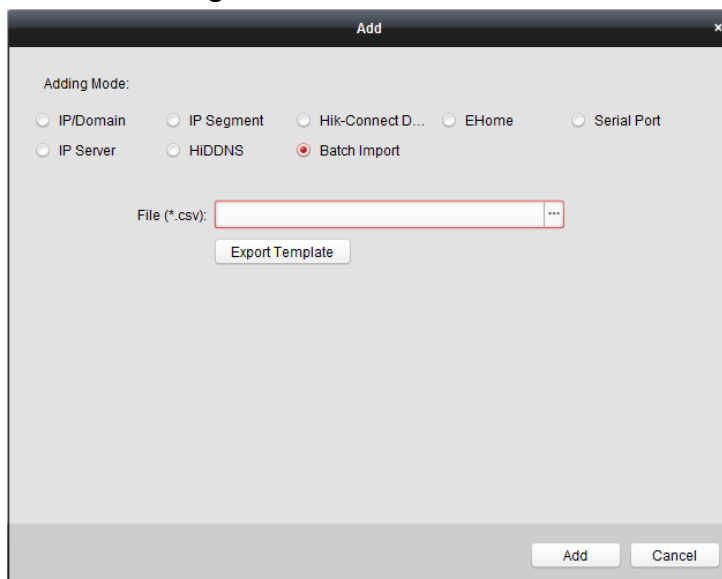

3. Click **Export Template** and save the pre-defined template (CSV file) on your PC.
4. Open the exported template file and input the required information of the devices to be added on the corresponding column.
 - **Nickname:** Edit a name for the device as you want.
 - **Adding Mode:** You can input 0, 2, 3, 4, 5, or 6 which indicated different adding modes. 0 indicates that the device is added by IP address or domain name; 2 indicates that the device is added via IP server; 3 indicates that the device is added via HiDDNS; 4 indicates that the device is added via EHome protocol; 5 indicates that the device is added by serial port; 6 indicates that the device is added via Hik-Connect Domain.
 - **Address:** Edit the address of the device. If you set 0 as the adding mode, you should input the IP address or domain name of the device; if you set 2 as the adding mode, you should input the IP address of the PC that installs the IP Server; if you set 3 as the adding mode, you should input *www.hik-online.com*.
 - **Port:** Input the device port No.. The default value is *8000*.
 - **Device Information:** If you set 0 as the adding mode, this field is not required; if you set 2 as the adding mode, input the device ID registered on the IP Server; if you set 3 as the adding mode, input the device domain name registered on HiDDNS server; if you set 4 as the adding mode, input the EHome account; if you set 6 as the adding mode, input the device serial No.
 - **User Name:** Input the device user name. By default, the user name is *admin*.
 - **Password:** Input the device password.



STRONG PASSWORD RECOMMENDED– We highly recommend you create a strong password of your own choosing (using a minimum of 8 characters, including upper case letters, lower

case letters, numbers, and special characters) in order to increase the security of your product. And we recommend you reset your password regularly, especially in the high security system, resetting the password monthly or weekly can better protect your product.

- **Add Offline Device:** You can input 1 to enable adding the offline device, and then the software will automatically connect it when the offline device comes online. 0 indicates disabling this function.
- **Export to Group:** You can input 1 to create a group by the device name (nickname). All the channels of the device will be imported to the corresponding group by default. 0 indicates disabling this function.
- **Channel Number:** If you set 1 for Add Offline Device, input the channel number of the device. If you set 0 for Add Offline Device, this field is not required.
- **Alarm Input Number:** If you set 1 for Add Offline Device, input the alarm input number of the device. If you set 0 for Add Offline Device, this field is not required.
- **Serial Port No.:** If you set 5 as the adding mode, input the serial port No. for the access control device.
- **Baud Rate:** If you set 5 as the adding mode, input the baud rate of the access control device.
- **DIP:** If you set 5 as the adding mode, input the DIP address of the access control device.
- **Hik-Connect Account:** If you set 6 as the adding mode, input the Hik-Connect account.
- **Hik-Connect Password:** If you set 6 as the adding mode, input the Hik-Connect password.

5. Click  and select the template file.

6. Click **Add** to import the devices.

The devices will be displayed on the device list for management after added successfully. You can check the resource usage, HDD status, recording status, and other information of the added devices on the list.

Click **Refresh All** to refresh the information of all added devices. You can also input the device name in the filter field for search.

6.3.2 Viewing Device Status

In the device list, you can select the device and then click **Device Status** button to view its status.

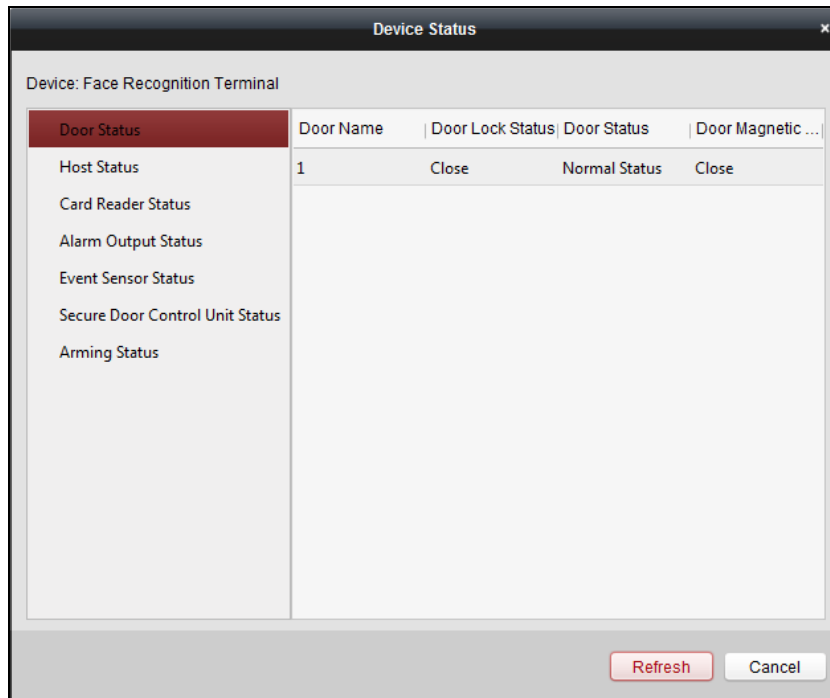

Note: The interface may differ from the picture displayed above. Refer to the actual interface when adopting this function.

- **Door Status:** The status of the connected door.
- **Host Status:** The status of the host, including Storage Battery Power Voltage, Device Power Supply Status, Multi-door Interlocking Status, Anti-passing Back Status, and Host Anti-Tamper Status.
- **Card Reader Status:** The status of card reader.

Note: If you use the card reader with RS-485 connection, you can view the status of online or offline. If you use the card reader with Wiegand connection, you can view the status of offline.
- **Alarm Output Status:** The alarm output status of each port.
- **Event Sensor Status:** The event sensor status of each port.
- **Secure Door Control Unit Status:** The online status and tamper status of the Secure Door Control Unit.
- **Arming Status:** The status of the device.

6.3.3 Editing Basic Information

Purpose:

After adding the access control device, you can edit the device basic information.

Steps:

1. Select the device in the device list.
2. Click **Modify** to pop up the modifying device information window.
3. Click **Basic Information** tab to enter the Basic Information interface.

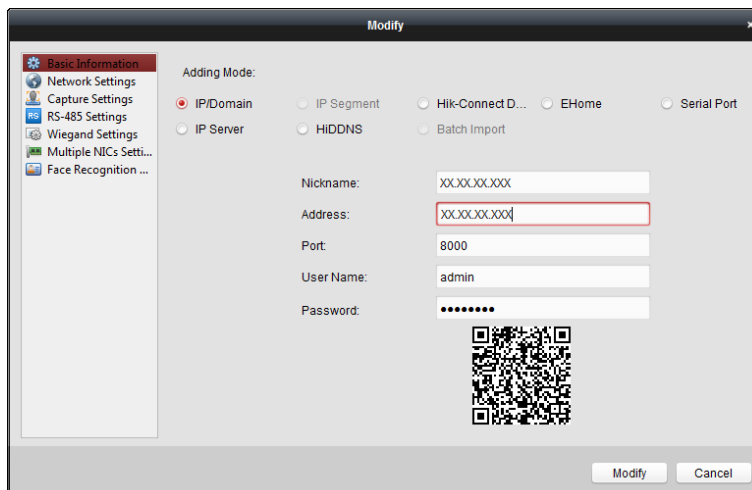

4. Edit the device information, including the adding mode, the device name, the device IP address, port No., user name, and the password.

6.3.4 Network Settings

Purpose:

After adding the access control device, you can set the uploading mode, and set the network center and wireless communication center.

Select the device in the device list, and click **Modify** to pop up the modifying device information window.

Click **Network Settings** tab to enter the network settings interface.

Uploading Mode Settings

Purpose :

You can set the center group for uploading the log via the EHome protocol.

Steps:

1. Click the **Uploading Mode** tab.

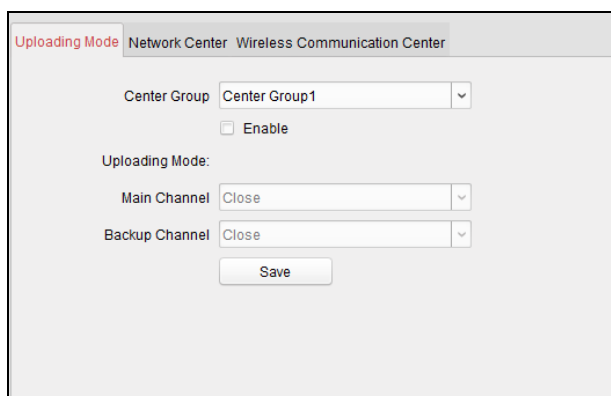

2. Select the center group in the dropdown list.
3. Check the **Enable** checkbox to enable the selected center group.
4. Select the uploading mode in the dropdown list. You can enable **N1/G1** for the main channel

and the backup channel, or select **Close** to disable the main channel or the backup channel.

Note: The main channel and the backup channel cannot enable N1 or G1 at the same time.

5. Click **Save** button to save parameters.

Network Center Settings

You can set the account for EHome protocol in Network Settings page. Then you can add devices via EHome protocol.

Steps:

1. Click the **Network Center** tab.

2. Select the center group in the dropdown list.
3. Select the Address Type as **IP Address** or **Domain Name**.
4. Input IP address or domain name according to the address type.
5. Input the port No. for the protocol. By default, the port No. is 7660.
6. Select the protocol type as EHome.
7. Set an account name for the network center.

Note: The account should contain 1 to 32 characters and only letters and numbers are allowed.

8. Click **Save** button to save parameters.

Notes:

- The port No. of the wireless network and wired network should be consistent with the port No. of EHome.
 - You can set the domain name in Enable NTP area *Editing Time* section in Remote Configuration. For details, refer to *Time* in 6.3.10 Remote Configuration.
- .

Wireless Communication Center Settings

Steps:

1. Click the **Wireless Communication Center** tab.

The screenshot shows a configuration window for a network center. At the top, there are three tabs: 'Uploading Mode', 'Network Center', and 'Wireless Communication Center'. The 'Wireless Communication Center' tab is active. Below the tabs, there are several input fields: 'APN Name' is a dropdown menu; 'SIM Card No.' is a text input field; 'Center Group' is a dropdown menu with 'Center1' selected; 'IP Address' is a text input field containing '0.0.0.0'; 'Port' is a text input field; 'Protocol Type' is a dropdown menu; and 'Account' is a text input field. A 'Save' button is located at the bottom center of the form.

2. Select the APN name as CMNET or UNINET.
3. Input the SIM Card No.
4. Select the center group in the dropdown list.
5. Input the IP address and port No.
6. Select the protocol type as EHome. By default, the port No. for EHome is 7660.
7. Set an account name for the network center. A consistent account should be used in one platform.
8. Click **Save** button to save parameters.

Note: The port No. of the wireless network and wired network should be consistent with the port No. of EHome.

6.3.5 Capture Settings

You can set the parameters of capture linkage and manual capture.

Select the device in the device list, and click **Modify** to pop up the modifying device information window.

Click **Capture Settings** tab to enter the capture settings interface.

Notes:

- The **Capture Settings** should be supported by the device.
- Before setting the capture setting, you should configure the storage server for picture storage.

Linked Capture

Steps:

1. Select the **Linked Capture** tab.

Linked Capture Manual Capture

Picture Size: Auto

Picture Quality: Medium

Capture Times: 1

Capture Interval 1: ms

Capture Interval 2: ms

Capture Interval 3: ms

Capture Interval 4: ms

Save

2. Set the picture size and quality.
3. Set the linked capture times once triggered.
4. Set the capture interval according to the capture times.
5. Click **Save** to save the settings.

Manual Capture

Steps:

1. Select the **Manual Capture** tab.

Linked Capture Manual Capture

Picture Size: Auto

Picture Quality: High

Save Restore Defa...

2. Select the resolution of the captured pictures from the dropdown list.
3. Select the picture quality as High, Medium, or Low.
4. Click **Save** to save the settings.
5. You can click **Restore Default Value** to restore the parameters to default settings.

6.3.6 RS-485 Settings

Purpose:

You can set the RS-485 parameters including the serial port, the baud rate, the data bit, the stop bit, the parity type, the communication mode, the working mode, and the connection mode.

Note: The RS-485 Settings should be supported by the device.

Steps:

1. Select the device in the device list, and click **Modify** to pop up the modifying device information window.
2. Click **RS-485 Settings** tab to enter the RS-485 settings interface.

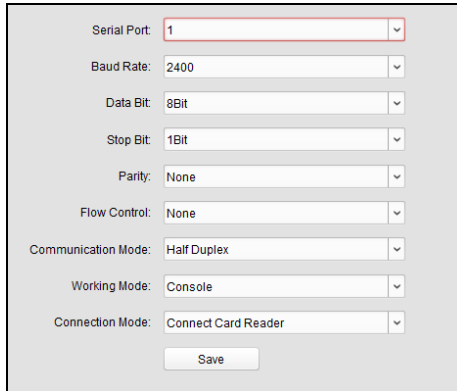

2. Select the serial No. of the port from the dropdown list to set the RS-485 parameters.
3. Set the baud rate, data bit, the stop bit, parity, flow control, communication mode, working mode, and the connection mode in the dropdown list.
4. Click **Save** to save the settings and the configured parameters will be applied to the device automatically.

Note: After changing the working mode, the device will be rebooted. A prompt will be popped up after changing the working mode.

6.3.7 Wiegand Settings

Purpose:

You can set the Wiegand channel and the communication mode.

Note: The Wiegand Settings should be supported by the device.

Steps:

1. Select the device in the device list, and click **Modify** to pop up the modifying device information window.
2. Click the **Wiegand Settings** tab to enter the Wiegand Settings interface.

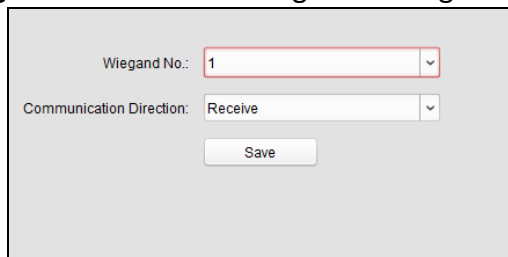

3. Select the Wiegand channel No. and the communication mode in the dropdown list.
If you set the **Communication Direction** as **Send**, you are required to set the Wiegand Mode as Wiegand 26 or Wiegand 34.
4. Click **Save** to save the settings and the configured parameters will be applied to the device automatically.

Note: After changing the communication direction, the device will be rebooted. A prompt will be popped up after changing the communication direction.

6.3.8 Setting Multiple NICs

Purpose:

You can set the parameters of NIC, NIC type, IPv4 address, Subnet Mask, Default Gateway, MAC, MTU, and device port.

Note: The function should be supported by the device.

Before you start:

Adding devices by EHome account.

Steps:

1. Click **Multiple NICs Settings** to enter the Multiple NICs settings page.

2. Set the parameters as you desired.
3. Click **Save** to save the settings.

6.3.9 Setting Face Recognition Terminal

Purpose:

You can set the face recognition terminal's mode, including the face recognition database, authenticate by QR code, and save authenticating face.

Note: The function should be supported by the device.

Steps:

1. Click **Face Recognition Terminal Settings** to enter the Face Recognition Terminal Settings page.

- Set the face recognition terminal's parameters.

The parameters descriptions are as follows:

Parameter	Description
Face Picture Database	You can select Deep Learning as the face picture database.
Authenticate by QR Code	If enabling the function, the device camera can scan the QR code to authenticate. By default, the function is disabled.
Save Authenticating Face Picture	If enabling the function, the captured face picture when authenticating will be saved to the device.

- Click **Save** to save the settings.

You can also set the parameters in the Remote Configuration. For details, see *6.3.10 Remote Configuration*.

6.3.10 Remote Configuration

Purpose:

In the device list, select the device and click **Remote Configuration** button to enter the remote configuration interface. You can set the detailed parameters of the selected device.

Checking Device Information

Steps:

- In the device list, you can click **Remote Configuration** to enter the remote configuration interface.
- Click **System** -> **Device Information** to check the device basic information and the device version information.

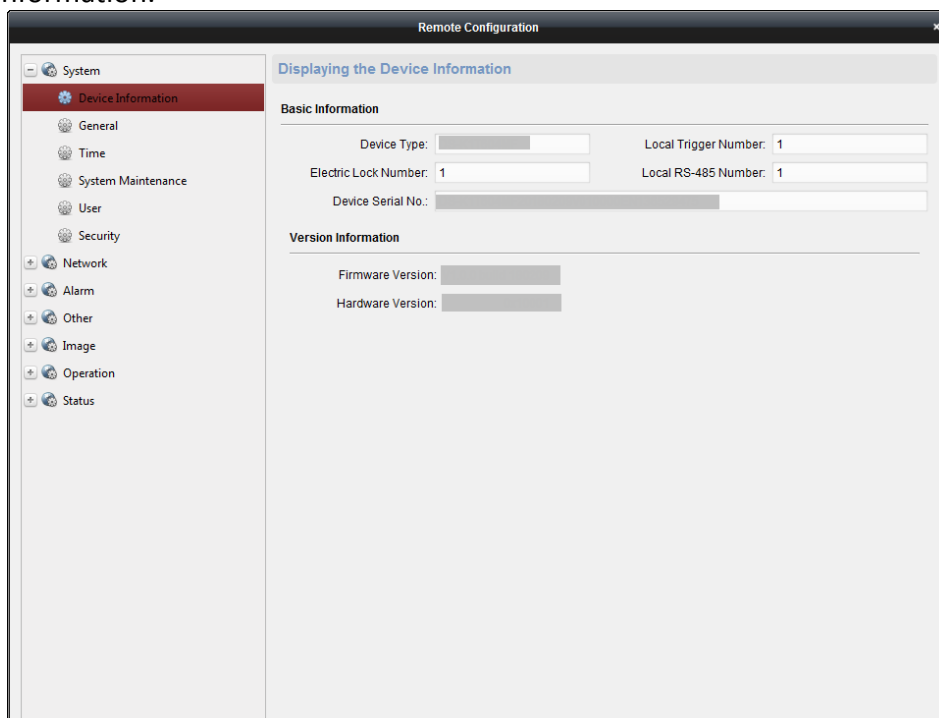

Editing Device Name

In the Remote Configuration interface, click **System** -> **General** to configure the device name and overwrite record files parameter. Click **Save** to save the settings.

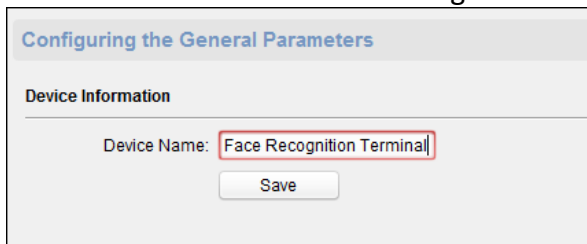

Configuring the General Parameters

Device Information

Device Name: Face Recognition Terminal

Save

Editing Time

Steps:

1. In the Remote Configuration interface, click **System** -> **Time** to configure the time zone.
2. (Optional) Check **Enable NTP** and configure the NTP server address, the NTP port, and the synchronization interval.
3. (Optional) Check **Enable DST** and configure the DST star time, end time and the bias.
4. Click **Save** to save the settings.

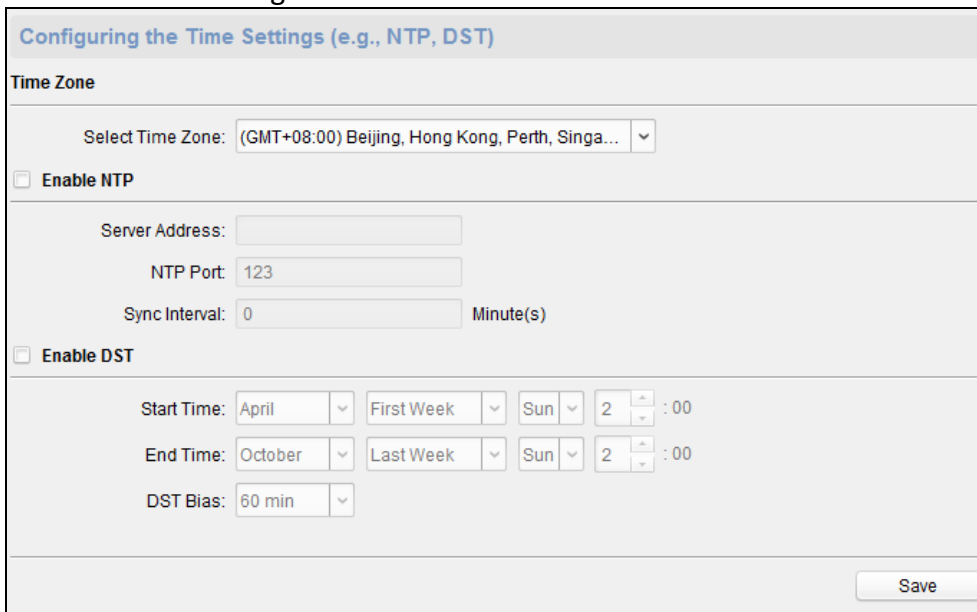

Configuring the Time Settings (e.g., NTP, DST)

Time Zone

Select Time Zone: (GMT+08:00) Beijing, Hong Kong, Perth, Singa...

Enable NTP

Server Address:

NTP Port: 123

Sync Interval: 0 Minute(s)

Enable DST

Start Time: April First Week Sun 2 :00

End Time: October Last Week Sun 2 :00

DST Bias: 60 min

Save

Setting System Maintenance

Purpose:

You can reboot the device remotely, restore the device to default settings, import configuration file, upgrade the device, etc.

Steps:

1. In the Remote Configuration interface, click **System** -> **System Maintenance**.
2. Click **Reboot** to reboot the device.
Or click **Restore Default Settings** to restore the device settings to the default ones, excluding the IP address.
Or click **Restore All** to restore the device parameters to the default ones. The device should be activated after restoring.

Note: The configuration file contains the device parameters.

Or click **Import Configuration File** to import the configuration file from the local PC to the device.

Or click **Export Configuration File** to export the configuration file from the device to the local PC

Note: The configuration file contains the device parameters.

3. You can also remote upgrade the device.

1) In the Remote Upgrade part, select an upgrade type.

Notes:

- You need to set the device ID before upgrading if you select Controller Upgrade File as the remote upgrade type.
- Only the card reader that connected via RS-485 protocol supports upgrading.
- If you need to upgrade the device system, make sure the controller version and the extension module’s version are the same. Here the controller refers to the TX1 system while the extension module refers to the MCU system.

2) Click to select the upgrade file.

3) Click **Upgrade** to start upgrading.

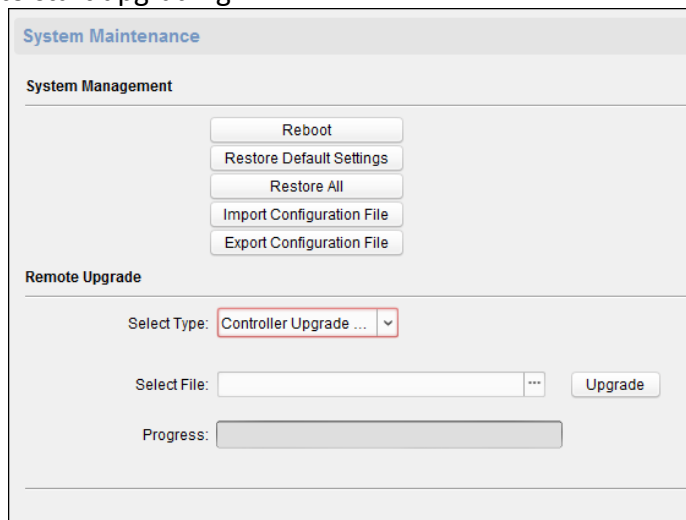

Managing User

Steps:

1. In the Remote Configuration interface, click **System -> User**.

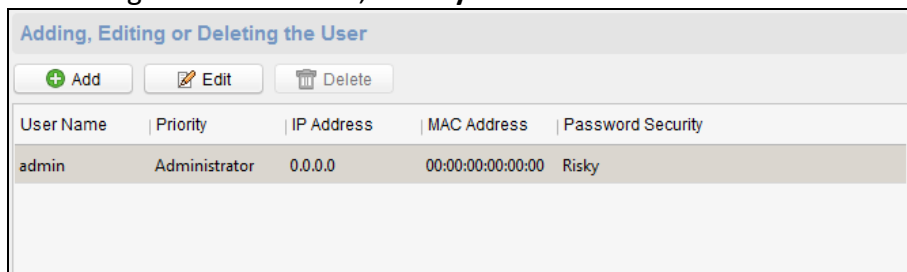

2. Click **Add** to add the user (Do not support by the elevator controller.).

Or select a user in the user list and click **Edit** to edit the user. You are able to edit the user password, the IP address, the MAC address and the user permission. Cilck **OK** to confirm editing.

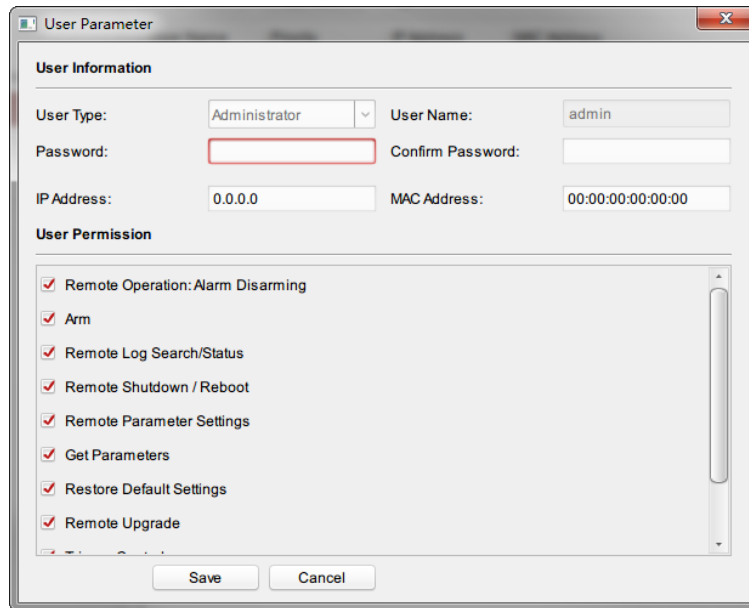

Setting Security

Steps:

1. Click **System** -> **Security**.

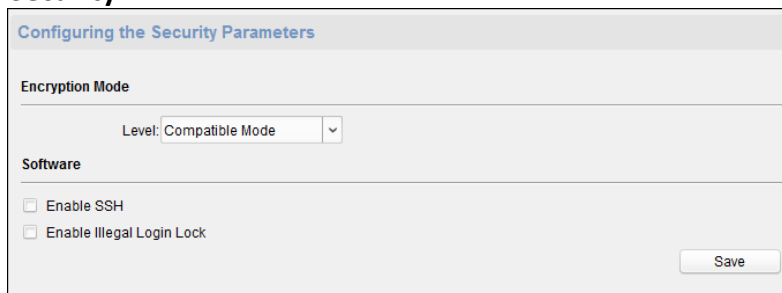

2. Select the encryption mode in the dropdown list.
You can select Compatible Mode or Encryption Mode.
3. Click **Save** to save the settings.

Configuring Network Parameters

Click **Network** -> **General**. You can configure the NIC, the NIC type, the IPv4 address, the subnet mask (IPv4), the default gateway (IPv4), MAC address, MTU, the device port, and the default NIC. Click **Save** to save the settings.

Configuring Upload Method

Purpose :

You can set the center group for uploading the log via the EHome protocol.

Steps:

1. Click **Network** -> **Report Strategy**.

2. Select a Center Group from the drop-down list.
3. Check the **Enable** check box.
4. Set the uploading method.
You can set the main channel and the backup channel.
5. Click **Settings** on the right of the channel field to set the detailed information.
6. Click **Save** to save the settings.

Configuring Network Center

You can set the notify surveillance center, center's IP address, the port No., the Protocol (EHome), and the EHome account user name to transmit data via EHome protocol. For details about EHome protocol's transmission, refer to *Network Center Settings* in *Chapter 6.3.4 Network Settings*. Click **Save** to save the settings or click

Configuring the Network Center Parameters

Notify Surveillance Center:

IP Address:

Port:

Protocol Type:

User Name:

Configuring Advanced Network

Click **Network** -> **Advanced Settings**. You can configure the DNS IP address 1 and the DNS IP address 2. Click **Save** to save the settings.

Configuring the Advanced Network Settings

DNS1 IP Address:

DNS2 IP Address:

Configuring Access Control Parameters

Steps:

1. In the Remote Configuration interface, click **Other** -> **Access Control Parameters**.
2. Select and check the item as you desired.

Overlay User Information on Picture: Display the user information on the captured picture.

Enable Voice Prompt: If check the checkbox, the voice prompt is enabled in the device. You can hear the voice prompt when operating in the device.

Upload Pictures after Capturing: If check the checkbox, the pictures captured by linked camera will be upload to the system automatically.

Save Captured Pictures: If you check the checkbox, you can save the picture captured by linked camera to the device.

Enable 3G/4G: If you check the checkbox, the device will enable the 3G/4G communication function.

3. Click **Save** to save the settings.

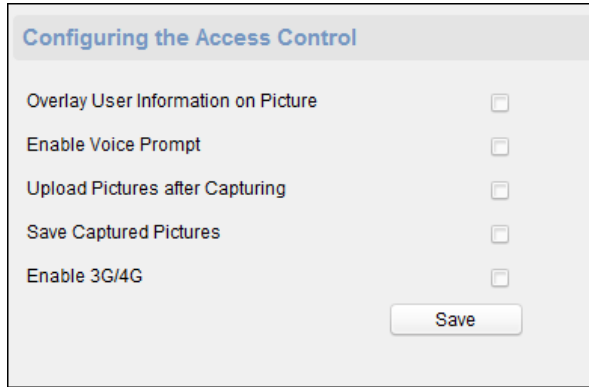

Configuring Face Recognition Terminal Parameters

Steps:

1. Click **Other – Face Recognition Terminal Parameters** to enter the Configuring Face Recognition Terminal Parameters page.

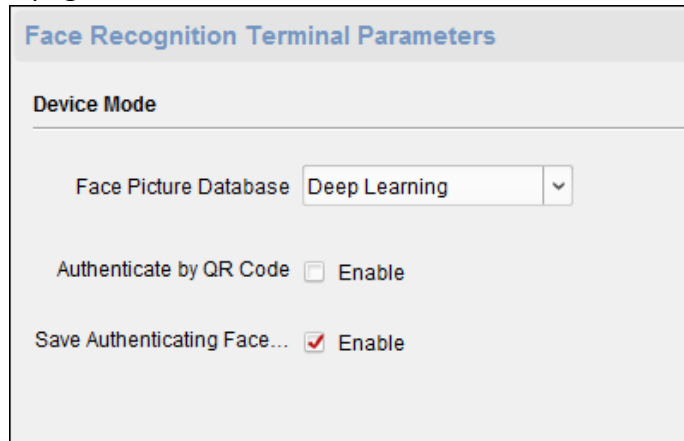

2. Set the parameters.

The parameters descriptions are as follows:

Parameter	Description
Face Picture Database	You can select Deep Learning as the face picture database.
Authenticate by QR Code	If enabling the function, the device camera can scan the QR code to authenticate. By default, the function is disabled.
Save Authenticating Face Picture	If enabling the function, the captured face picture when authenticating will be saved to the device.

Configuring Face Picture Parameters

Click **Other – Face Picture Parameters** to enter the Configuring Face Picture Parameters page. You can set the face picture parameters when authenticating. Click **Save** to save the settings.

The parameters descriptions are as follows:

Parameter	Description
Min. Detection Width (Close to)	When the distance between the camera and the user is short, the parameter represents the minimum

Parameter	Description
	percentage of the facial width in the total width of the recognition area. The actual percentage should be larger than the configured value when face picture authentication. In this condition, the device will not detect other parameters.
Pitch Angle	The maximum pitch angle when face authentication. By default, the angle is 30°.
Yaw Angle	The maximum yaw angle when face authentication. By default, the angle is 45°.
Min. Detection Area (Width)	When the distance between the camera and the user is long, the parameter represents the minimum percentage of the facial width in the total width of the recognition area. The actual percentage should be larger than the configured value when face picture authentication. Other percentages, distances and angles in this table should also meet their conditions. Recommended Value: 14
Min. Detection Area (Height)	When the distance between the camera and the user is long, the parameter represents the minimum percentage of the facial height in the total height of the recognition area. The actual percentage should be larger than the configured value when face picture authentication. Other percentages, distances and angles in this table should also meet their conditions. Recommended Value: 12
Margin (Left)	The distance from the face left side to the left margin in the recognition area. The actual distance should be larger than the configured value when face picture authentication. Other percentages, distances, and angles should also meet their conditions.
Margin (Right)	The distance from the face right side to the right margin in the recognition area. The actual distance should be larger than the configured value when face picture authentication. Other percentages, distances, and angles should also meet their conditions.
Margin (Top)	The distance from the face top side to the top margin in the recognition area. The actual distance should be larger than the configured

Parameter	Description
	value when face picture authentication. Other percentages, distances, and angles should also meet their conditions.
Margin (Bottom)	The distance from the face bottom side to the bottom margin in the recognition area. The actual distance should be larger than the configured value when face picture authentication. Other percentages, distances, and angles should also meet their conditions.
Pupillary Distance	The minimum resolution between two pupils when face recognition. The actual resolution should be larger than the configured value. By default, the resolution is 40.

Configuring Supplement Light Parameters

Purpose:

You can turn on or off the supplement light. If the supplement light is in auto mode, you can also adjust the supplement light brightness.

Steps:

1. Click **Other – Supplement Light Parameters** to enter the Configuring Supplement Light Parameters page.

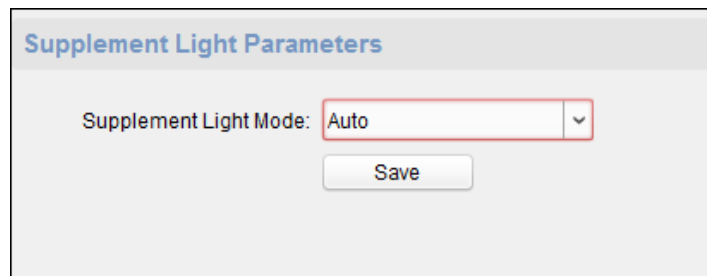

2. Select a supplement light mode from the drop-down list.
3. (Optional) If the supplement light mode is **Auto**, you can set the supplement light brightness.
4. Click **Save** to save the settings.

Configuring Video and Audio Parameters

Purpose:

You can set the device camera’s image quality, resolution and other parameters.

Steps:

1. Click **Image – Video & Audio** to enter the settings page.

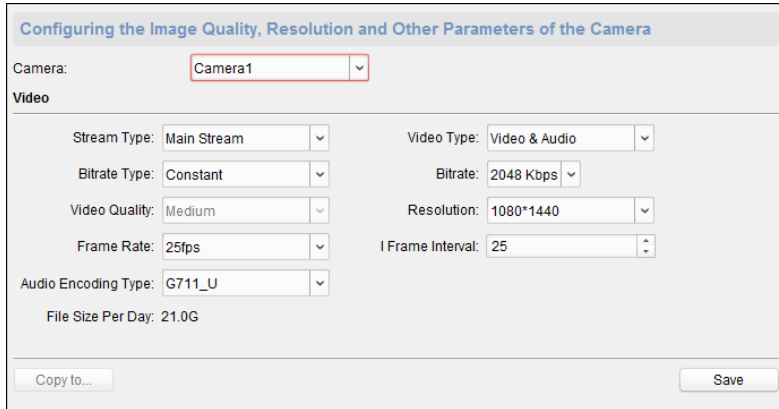

2. Set the device camera's parameters, including the stream type, the bitrate type, the video quality, the frame rate, the audio encoding type, the video type, the bitrate, the resolution, and the I frame interval.
3. Click **Save** to save the settings.

Configuring Volume Input or Output

Steps:

1. Click **Image – Volume Input/Output** to enter the Configuring the Volume Input or Output page.

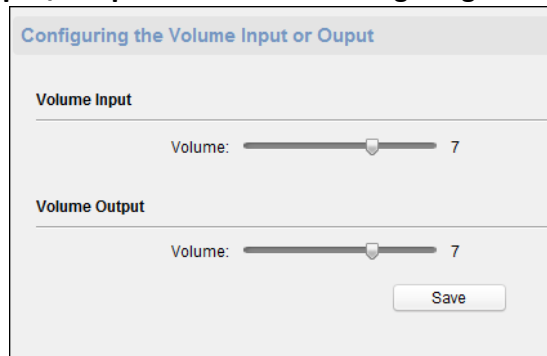

2. Set the device input volume or output volume.
3. Click **Save** to save the parameters.

Operating Relay

1. Click **Operation -> Relay**.
You can view the relay status.
2. Check the relay checkbox
3. Click **Open** or **Close** to open/close the relay.
4. (Optional) Click **Refresh** to refresh the relay status.



Viewing Relay Status

Click **Status -> Relay** to view the relay status.

Relay Status	
Relay	Status
Relay1	Close

6.4 Organization Management

You can add, edit, or delete the organization as desired.

Click  tab to enter the Person and Card Management interface.

6.4.1 Adding Organization

Steps:

1. In the organization list on the left, you should add a top organization as the parent organization of all organizations.

Click **Add** button to pop up the adding organization interface.

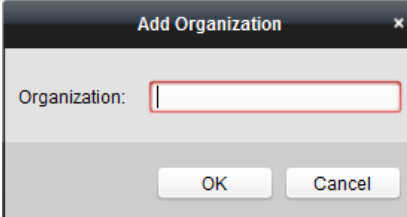

The image shows a dialog box titled "Add Organization" with a close button (X) in the top right corner. Inside the dialog, there is a label "Organization:" followed by a text input field. At the bottom of the dialog, there are two buttons: "OK" and "Cancel".

2. Input the Organization Name as desired.
3. Click **OK** to save the adding.
4. You can add multiple levels of organizations according to the actual needs.
To add sub organizations, select the parent organization and click **Add**.
Repeat *Step 2* and *3* to add the sub organization.
Then the added organization will be the sub-organization of the upper-level organization.

Note: Up to 10 levels of organizations can be created.

6.4.2 Modifying and Deleting Organization

You can select the added organization and click **Modify** to modify its name.

You can select an organization, and click **Delete** button to delete it.

Notes:

- The lower-level organizations will be deleted as well if you delete an organization.
- Make sure there is no person added under the organization, or the organization cannot be deleted.

6.5 Person Management

After adding the organization, you can add person to the organization and manage the added person such as issuing cards in batch, importing and exporting person information in batch, etc.

Note: Up to 10,000 persons or cards can be added.

6.5.1 Adding Person

Adding Person (Basic Information)

Steps:

1. Select an organization in the organization list and click **Add** button on the Person panel to pop up the adding person dialog.

2. The Person No. will be generated automatically and is not editable.
3. Input the basic information including person name, gender, phone No., birthday details, and email address.
4. Click **Upload Picture** to select the person picture from the local PC to upload it to the client.
Note: The picture should be in *.jpg format.
5. (Optional) You can also click **Take Photo** to take the person's photo with the PC camera.
6. Click **OK** to finish adding.

Adding Person (Detailed Information)

Steps:

1. In the Add Person interface, click **Details** tab.

2. Input the detailed information of the person, including person's ID type, ID No., country, etc., according to actual needs.
 - **Linked Device:** You can bind the indoor station to the person.
 - Note:** If you select **Analog Indoor Station** in the Linked Device, the **Door Station** field will display and you are required to select the door station to communicate with the analog indoor station.
 - **Room No.:** You can input the room No. of the person.
3. Click **OK** to save the settings.

Adding Person (Permission)

You can assign the permissions (including operation permissions of access control device and access control permissions) to the person when adding person.

Note: For setting the access control permission, refer to *Chapter 6.7 Permission Configuration*.

Steps:

1. In the Add Person interface, click **Permission** tab.

2. In the Device Operation Role field, select the role of operating the access control device.
 - Normal User:** The person has the permission to check-in/out on the device, pass the access control point, etc.
 - Administrator:** The person has the normal user permission, as well as permission to configure the device, including adding normal user, etc.
3. In the Permission(s) to Select list, all the configured permissions display. Check the permission(s) checkbox(es) and click > to add to the Selected Permission(s) list. (Optional) You can click >> to add all the displayed permissions to the Selected Permission(s)

list.

(Optional) In the Selected Permission(s) list, select the selected permission and click < to remove it. You can also click << to remove all the selected permissions.

4. Click **OK** to save the settings.

Adding Person (Card)

You can add card and issue the card to the person.

➤ Adding General Card

Steps:

1. In the Add Person interface, click **Card** tab.

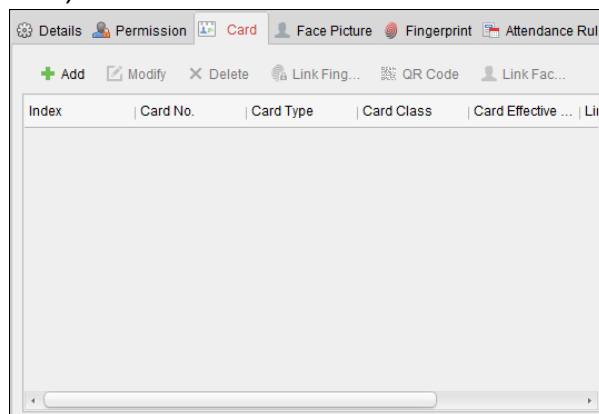

2. Click **Add** to pop up the Add Card dialog.

3. Click **Card** to enter the Card tab.

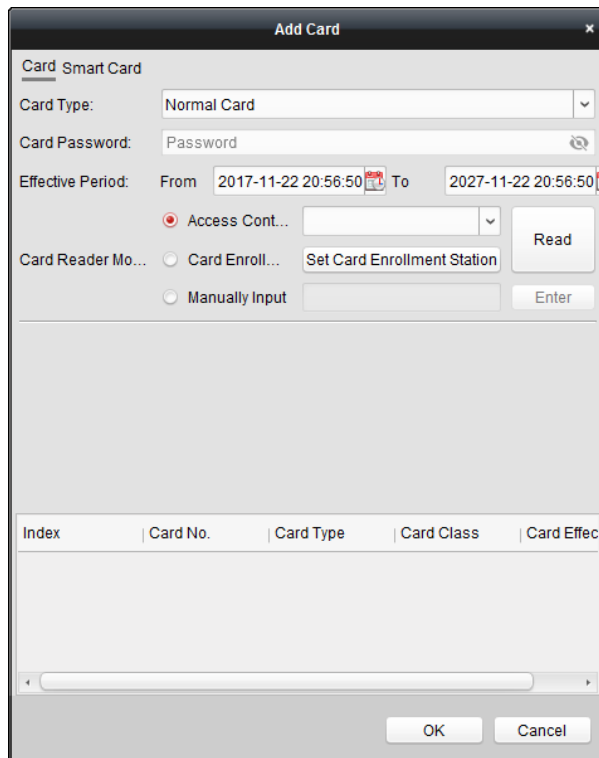

4. Select the card type according to actual needs.

- **Normal Card**

- **Card for Disabled Person:** The door will remain open for the configured time period for the card holder.
- **Card in Blacklist:** The card swiping action will be uploaded and the door cannot be opened.
- **Patrol Card:** The card swiping action can be used for checking the working status of the inspection staff. The access permission of the inspection staff is configurable.
- **Duress Card:** The door can open by swiping the duress card when there is duress. At the same time, the client can report the duress event.
- **Super Card:** The card is valid for all the doors of the controller during the configured schedule.
- **Visitor Card:** The card is assigned for visitors. For the Visitor Card, you can set the **Max. Swipe Times**.

Note: The Max. Swipe Times should be between 0 and 255. When setting as 0, it means the card swiping is unlimited.

5. Input the password of the card itself in the Card Password field. The card password should contain 4 to 8 digits.

Note: The password will be required when the card holder swiping the card to get enter to or exit from the door if you enable the card reader authentication mode as **Card and Password**, **Password and Fingerprint**, and **Card, Password, and Fingerprint**.

6. Click  to set the effective time and expiry time of the card.

7. Select the Card Reader Mode for reading the card No.

- **Access Controller Reader:** Place the card on the reader of the Access Controller and click **Read** to get the card No.
- **Card Enrollment Station:** Place the card on the Card Enrollment Station and click **Read** to get the card No.

Note: The Card Enrollment Station should connect with the PC running the client. You can click **Set Card Enrollment Station** to enter the following dialog.

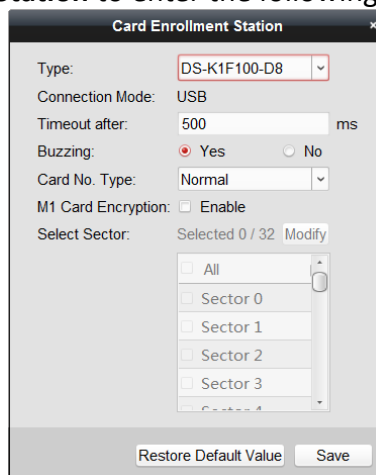

1) Select the Card Enrollment Station type.

Note: Currently, the supported card reader types include DS-K1F100-D8, DS-K1F100-M, DS-K1F100-D8E, and DS-K1F180-D8E.

2) Set the serial port No., the baud rate, the timeout value, the buzzing, or the card No. type.

If the card is M1 card, and if you need to enable the M1 Card Encryption function, you should check **Enable** checkbox of M1 Card Encryption and click **Modify** to select the sector.

3) Click **Save** button to save the settings.

You can click **Restore Default Value** button to restore the defaults.

- **Manually Input:** Input the card No. and click **Enter** to input the card No.

8. Click **OK** and the card(s) will be issued to the person.

9. (Optional) You can select the added card and click **Modify** or **Delete** to edit or delete the card.

10. (Optional) You can generate and save the card QR code for QR code authentication.

1) Select an added card and click **QR Code** to generate the card QR code.

2) In the QR code pop-up window, click **Download** to save the QR code to the local PC.

You can print the QR code for authentication on the specified device.

Note: The device should support the QR code authentication function. For details about setting the QR code authentication function, see the specified device user manual.

11. (Optional) You can click **Link Fingerprint** to link the card with the person's fingerprint, so that the person can place the finger on the scanner instead of swiping card when passing the door.

12. (Optional) You can click **Link Face Picture** to link the card with the face picture, so that the person can pass the door by scanning the face via the device instead of swiping card when passing the door.

13. Click **OK** to save the settings.

➤ **Adding Smart Card**

Purpose:

You can store fingerprints and ID card information in the smart card. When authenticating, after swiping the smart card on the device, you can scan your fingerprint or swipe your ID card on the device. The device will compare the fingerprint or ID card information in the smart card with the ones collected. If you use the smart card for authentication, there is no need to store the fingerprints or ID card information in the device in advance.

Steps:

1. In the Add Person page, set the person basic information.
2. Click **Card** to enter the card tab.
3. Click **Add** to pop up the Add Card dialog.
4. Click **Smart Card** to enter the Smart Card tab.

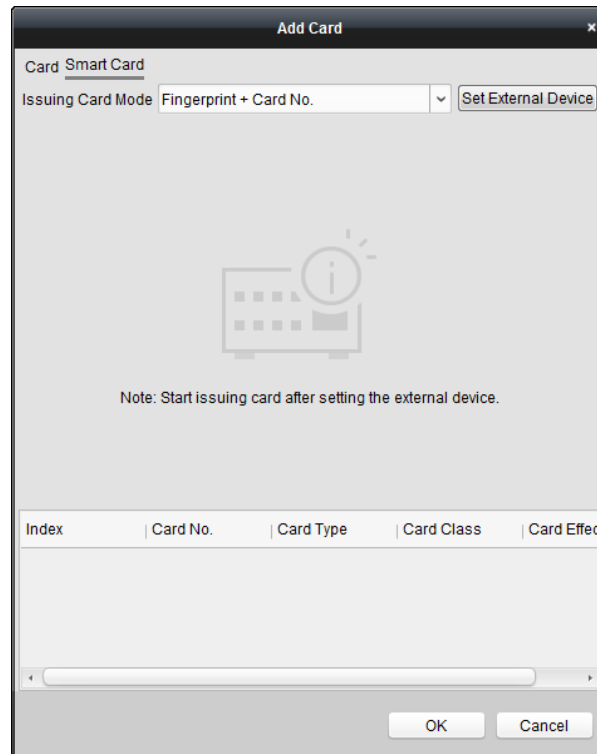

5. Select an issuing card mode from the dropdown list.
6. Set the external device.
 - 1) Click **Set External Device** to enter the Set External Device page.
 - 2) (Optional) Select the issuing card mode again.
 - 3) Set a card enrollment station.
 - 4) If you select “Fingerprint + Card No.” as the issuing mode, set the fingerprint recorder model.
If you select “ID Card No. + Card No.” as the issuing mode, set the ID card reader model.
If you select “Fingerprint + ID Card No. + Card No.” as the issuing mode, set the fingerprint recorder model and the ID card reader model.
 - 5) Click **OK** save the settings.
7. Select a card type for the smart card.
 - **Normal Card**
 - **Card for Disabled Person:** The door will remain open for the configured time period for the card holder.
 - **Card in Blacklist:** The card swiping action will be uploaded and the door cannot be opened.
 - **Patrol Card:** The card swiping action can be used for checking the working status of the inspection staff. The access permission of the inspection staff is configurable.
 - **Duress Card:** The door can be opened by swiping the duress card when there is duress. At the same time, the client can report the duress event.
 - **Super Card:** The card is valid for all the doors of the controller during the configured schedule.
 - **Visitor Card:** The card is assigned for visitors. For the Visitor Card, you can set the Max. Swipe Times.

Note: The Max. Swipe Times should be between 0 and 255. When setting as 0, it means the card swiping is unlimited.

- **Dismiss Card:** Swipe the card to dismiss alarm.

8. Set other parameters of the card.

- 1) Set the card password.
- 2) Set the card effective date.
- 3) Scan your fingerprint and swipe your ID card according to the prompt.
- 4) Swipe the smart card.

The added card information will display in the list below.

9. Click **OK** and the card(s) will be issued to the person.

10. (Optional) Select the added card and click **Modify** or **Delete** to edit or delete the card.

11. (Optional) Generate and save the card QR code for QR code authentication.

- 1) Select an added card and click **QR Code** to generate the card QR code.
- 2) In the QR code pop-up window, click **Download** to save the QR code to the local PC.

You can print the QR code for authentication on the specified device.

Note: The device should support the QR code authentication function. For details about setting the QR code authentication function, see the specified device user manual.

12. (Optional) Click **Link Fingerprint** to link the card with the person's fingerprint, so that the person can place the finger on the scanner instead of swiping card when passing the door.

13. (Optional) Click **Link Face Picture** to link the card with the face picture, so that the person can pass the door by scanning the face via the device instead of swiping card when passing the door.

14. Click **OK** to save the settings.

Adding Person (Face Picture)

You can collect the face picture in two ways: Local Collection and Remote Collection.

- **Local Upload:** Upload local the face pictures from the local PC.
- **Local Collection:** Collect the face picture via face picture scanner.
- **Remote Collection:** Collect the face picture via the access control terminal.

Note: The access control terminal should support face recognition function.

Steps:

1. In the Add Person interface, click **Face Picture** tab.

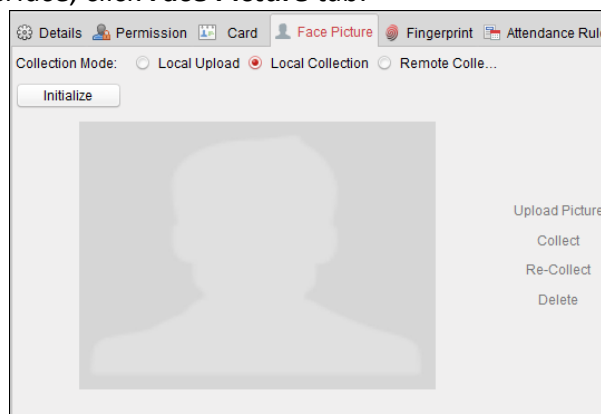

2. To upload the face picture from the local PC:

- 1) Select **Local Upload**.

- 2) Click **Upload Picture** and select a face picture from the local PC.
Note: The uploaded picture should be in JPG format and the size should be less than 200K.
- 3) (Optional) By default, the uploaded face picture should be verified by the device.
You can select a device from the drop-down list to verify the uploaded face picture. Only after the face picture is verified, the face picture is adding completely.
3. To get the face picture via face picture scanner:
 - 1) Select **Local Collection**.
 - 2) Connect the face picture scanner to the PC.
 - 3) Select a device type.
Note: Currently, the face picture scanner of DS2CS5432B-S is supported.
 - 4) (Optional) You can click **Initialize** to initialize the face picture scanner.
4. To get the face picture via access control terminal:
 - 1) Select **Remote Collection**.
 - 2) Click **Select Device** to select the access control terminal which supports face recognition function.
5. Click **Collect** to capture the face picture.
You can click **Re-Collect** the captured picture again.
You can click **Delete** to delete the captured picture.
6. Click **OK** to save the settings.

Adding Person (Fingerprint)

Steps:

1. In the Add Person interface, click **Fingerprint** tab.



2. Select **Local Collection** as desired.
3. Before inputting the fingerprint, you should connect the fingerprint machine to the PC and set its parameters first.
Click **Set Fingerprint Machine** to enter the following dialog box.

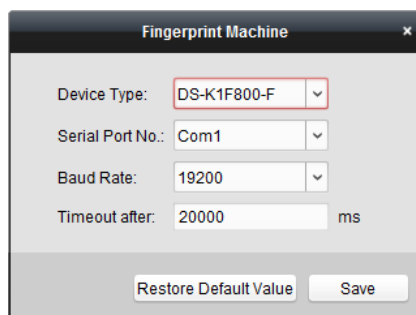

- 1) Select the device type.
Currently, the supported fingerprint machine types include DS-K1F800-F, DS-K1F810-F, DS-K1F820-F, and DS-K1F181-F.
- 2) For fingerprint machine type DS-K1F800-F, you can set the serial port number, baud rate, and overtime parameters of the fingerprint machine.
- 3) Click **Save** button to save the settings.
You can click **Restore Default Value** button to restore the default settings.

Notes:

- The serial port number should correspond to the serial port number of PC. You can check the serial port number in Device Manager in your PC.
 - The baud rate should be set according to the external fingerprint card reader. The default value is 19200.
 - **Timeout after** field refers to the valid fingerprint collecting time. If the user does not input a fingerprint or inputs a fingerprint unsuccessfully, the device will indicate that the fingerprint collecting is over.
4. Click **Start** button, click to select the fingerprint to start collecting.
 5. Lift and rest the corresponding fingerprint on the fingerprint scanner twice to collect the fingerprint to the client.
 6. (Optional) You can also click **Remote Collection** to collect fingerprint from the device.
Note: The function should be supported by the device.
 7. (Optional) You can select the registered fingerprint and click **Delete** to delete it.
You can click **Clear** to clear all fingerprints.
 8. Click **OK** to save the fingerprints.

Adding Person (Attendance Rule)

You can set the attendance rule for the person.

Note: This tab page will display when you select **Non-Residence** mode in the application scene when running the software for the first time.

Steps:

1. In the Add Person interface, click **Attendance Rule** tab.

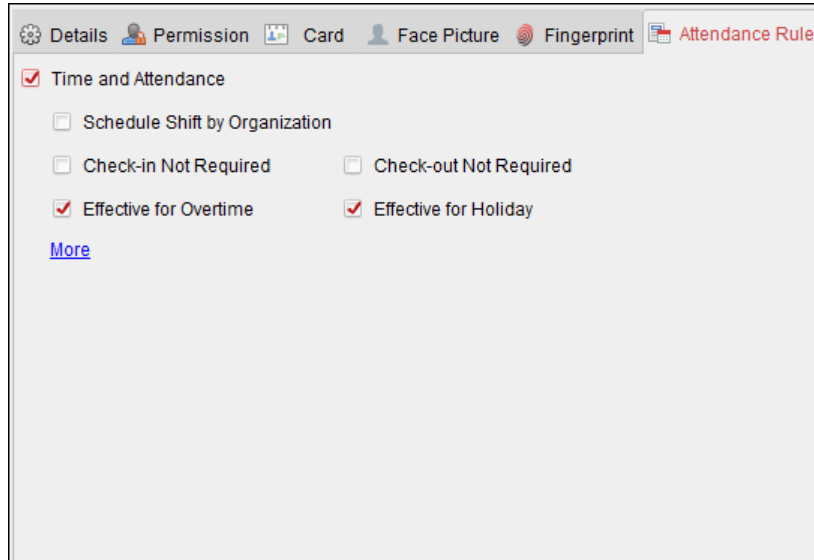

2. If the person joins in the time and attendance, check the **Time and Attendance** checkbox to enable this function for the person. Then the person's card swiping records will be recorded and analyzed for time and attendance.
For details about Time and Attendance, click **More** to go to the Time and Attendance module.
3. Click **OK** to save the settings.

Importing Person Information

Purpose:

You can import the information of multiple persons (including identity information, fingerprint data, and fingerprint linked card number) to the client software in a batch by importing an Excel file from the local PC.

Steps:

1. Click **Import Person** and click **Person Information** as the content to import.
2. In the pop-up window, click **Download Template for Importing Person** to download the template first.
3. Input the person information in the downloaded template.
Note: If the person has multiple cards, separate the card No. with semicolon.
4. Select the Excel file with the person information.
5. Click **OK** to start importing.
Note: If the person No. already exists in the client software's database, it will replace the person information automatically after importing.

Importing Person Pictures

Purpose:

After adding the persons, you can import multiple person pictures in a batch by importing a ZIP file with pictures to the client software.

Steps:

1. Name the person picture after the person name.
Note: The picture should be in JPG format and smaller than 200 KB.

2. Compress the file which contains the person pictures to ZIP format.
3. In the Person and Card module, click **Import Person** and click **Person Pictures** as the content to import.
4. In the pop-up window, select the ZIP file.
5. Click **OK** to start importing.

Note: By default, the imported person picture is linked with the person's first card.

Exporting Person Information

You can export the added persons's information to the local PC in Excel format.

Steps:

1. After adding the person, you can click **Export Person** button to pop up the Export Person window.
2. Select the path of saving the exported Excel file.
3. Select the items of person information to export.
4. Click **OK** to start exporting.

Getting Person Information from Access Control Device

If the added access control device has been configured with person information (including person details, fingerprint, issued card information), you can get the person information from the device and import to the client for further operation.

Note: This function is only supported by the device the connection method of which is TCP/IP when adding the device.

Steps:

1. In the organization list on the left, click to select an organization to import the persons.
2. Click **Get Person** button to pop up the following dialog box.

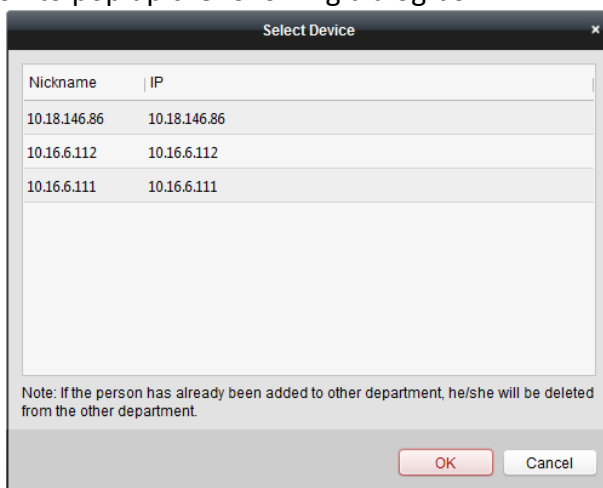

3. The added access control device will be displayed.
4. Click to select the device and then click **OK** to start getting the person information from the device.

You can also double click the device name to start getting the person information.

Notes:



- The person information, including person details, person's fingerprint information (if

configured), and the linked card (if configured), will be imported to the selected organization.

- If the person name stored in the device is empty, the person name will be filled with the issued card No. after importing to the client.
- The gender of the persons will be **Male** by default.
- Up to 10000 persons can be imported.

6.5.2 Managing Person

Modifying and Deleting Person

To modify the person information and attendance rule, click  or  in the Operation column, or select the person and click **Modify** to open the editing person dialog.

You can click  to view the person's card swiping records.

To delete the person, select a person and click **Delete** to delete it.

Note: If a card is issued to the current person, the linkage will be invalid after the person is deleted.

Changing Person to Other Organization

You can move the person to another organization if needed.

Steps:

1. Select the person in the list and click **Change Organization** button.

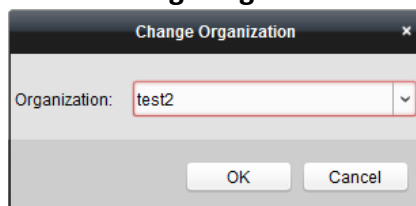

2. Select the organization to move the person to.
3. Click **OK** to save the settings.

Searching Person

You can input the keyword of card No. or person name in the search field, and click **Search** to search the person.

You can input the card No. by clicking **Read** to get the card No. via the connected card enrollment station.

You can click **Set Card Enrollment Station** in the dropdown list to set the parameters.

6.5.3 Issuing Card in Batch

You can issue multiple cards for the person with no card issued in batch.

Steps:

1. Click **Issue Card in Batch** button to enter the following dialog.
All the added person with no card issued will display in the Person(s) with No Card Issued list.

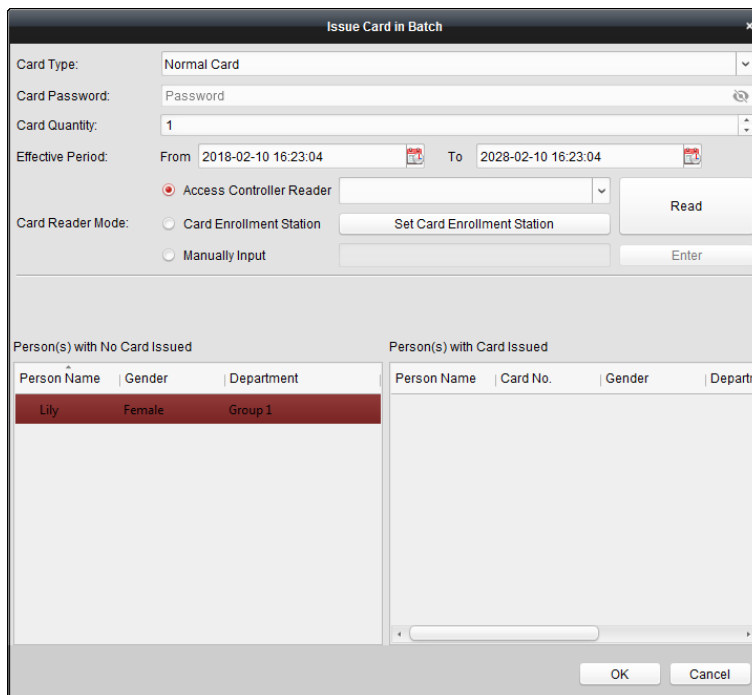

2. Select the card type according to actual needs.
Note: For details about the card type, refer to *Adding Person*.
3. Input the password of the card itself in the Card Password field. The card password should contain 4 to 8 digits.
Note: The password will be required when the card holder swiping the card to get enter to or exit from the door if you enable the card reader authentication mode as **Card and Password**, **Password and Fingerprint**, and **Card, Password, and Fingerprint**.
4. Input the card quantity issued for each person.
 For example, if the Card Quantity is 3, you can read or enter three card No. for each person.
5. Click  to set the effective time and expiry time of the card.
6. In the Person(s) with No Card Issued list on the left, select the person to issue card.
Note: You can click on the Person Name, Gender, and Department column to sort the persons according to actual needs.
7. Select the Card Reader Mode for reading the card No.
 - **Access Controller Reader:** Place the card on the reader of the Access Controller and click **Read** to get the card No.
 - **Card Enrollment Station:** Place the card on the Card Enrollment Station and click **Read** to get the card No.
Note: The Card Enrollment Station should connect with the PC running the client. You can click **Set Card Enrollment Station** to enter the following dialog.

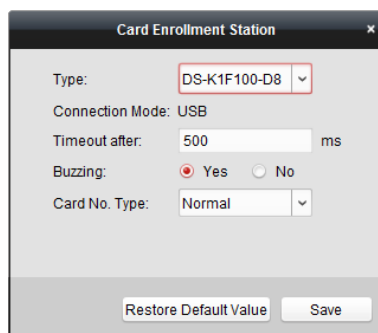

- 1) Select the Card Enrollment Station type.

Note: Currently, the supported card reader types include DS-K1F100-D8, DS-K1F100-M, DS-K1F100-D8E, and DS-K1F180-D8E.

- 2) Set the parameters about the connected card enrollment station.

If the card is M1 card, and if you need to enable the M1 Card Encryption function, you should check **Enable** checkbox of M1 Card Encryption and click **Modify** to select the sector.

- 3) Click **Save** button to save the settings.

You can click **Restore Default Value** button to restore the defaults.

- **Manually Input:** Input the card No. and click **Enter** to input the card No.

8. After issuing the card to the person, the person and card information will display in the Person(s) with Card Issued list.
9. Click **OK** to save the settings.

6.6 Schedule and Template

Purpose:

You can configure the template including week schedule and holiday schedule. After setting the templates, you can adopt the configured templates to access control permissions when setting the permission, so that the access control permission will take effect in the time durations of the template.

Click  to enter the schedule and template interface.

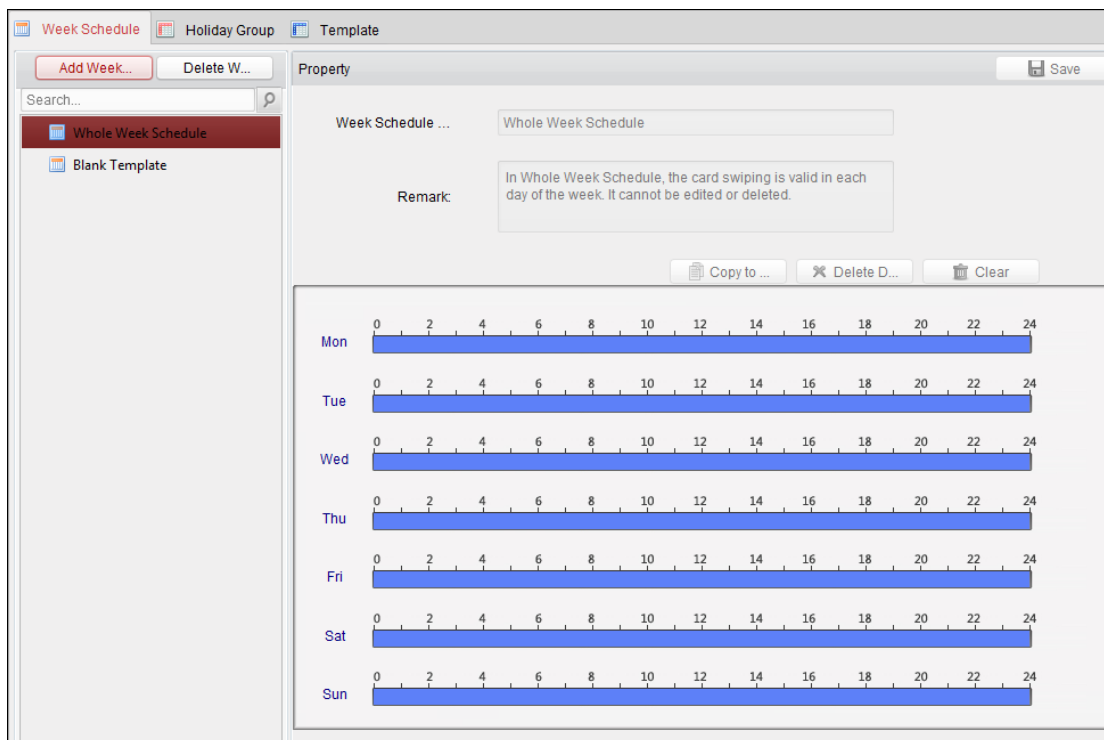

You can manage the schedule of access control permission including Week Schedule, Holiday Schedule, and Template. For permission settings, please refer to *Chapter 6.7 Permission Configuration*.

6.6.1 Week Schedule

Click **Week Schedule** tab to enter the Week Schedule Management interface.

The client defines two kinds of week plan by default: **Whole Week Schedule** and **Blank Schedule**, which cannot be deleted and edited.

- **Whole Week Schedule:** Card swiping is valid on each day of the week.
- **Blank Schedule:** Card swiping is invalid on each day of the week.

You can perform the following steps to define custom schedules on your demand.

Steps:

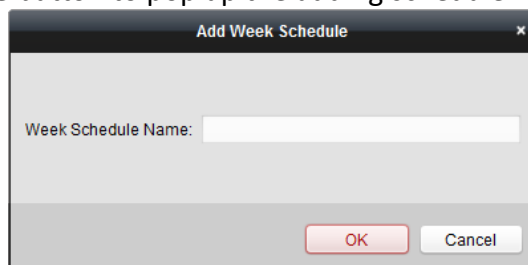

1. Click **Add Week Schedule** button to pop up the adding schedule interface.



2. Input the name of week schedule and click **OK** button to add the week schedule.
3. Select the added week schedule in the schedule list and you can view its property on the right. You can edit the week schedule name and input the remark information.
4. On the week schedule, click and drag on a day to draw on the schedule, which means in that

period of time, the configured permission is activated.

Note: Up to 8 time periods can be set for each day in the schedule.

5. When the cursor turns to , you can move the selected time bar you just edited. You can also edit the displayed time point to set the accurate time period. When the cursor turns to , you can lengthen or shorten the selected time bar.
6. Optionally, you can select the schedule time bar, and then click **Delete Duration** to delete the selected time bar, or click **Clear** to delete all the time bars, or click **Copy to Week** to copy the time bar settings to the whole week.
7. Click **Save** to save the settings.

6.6.2 Holiday Group

Click **Holiday Group** tab to enter the Holiday Group Management interface.

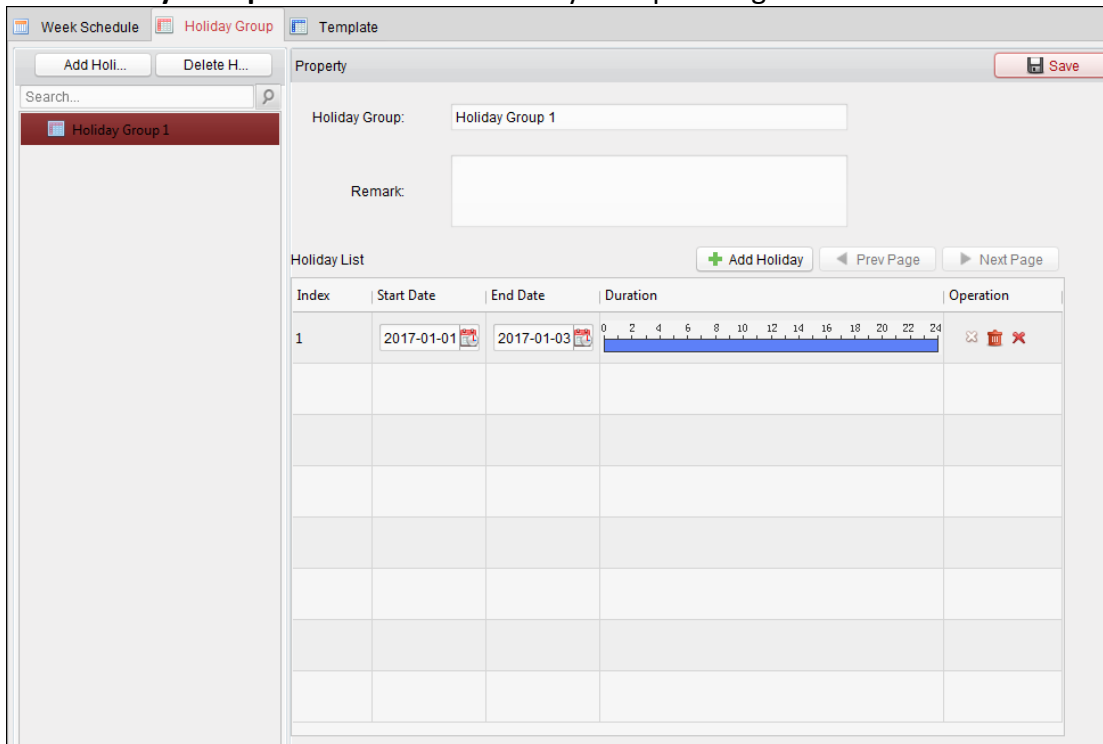

Steps:

1. Click **Add Holiday Group** button on the left to pop up the adding holiday group interface.

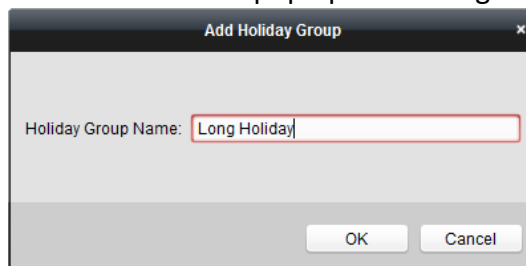

2. Input the name of holiday group in the text filed and click **OK** button to add the holiday group.
3. Select the added holiday group and you can edit the holiday group name and input the remark

information.



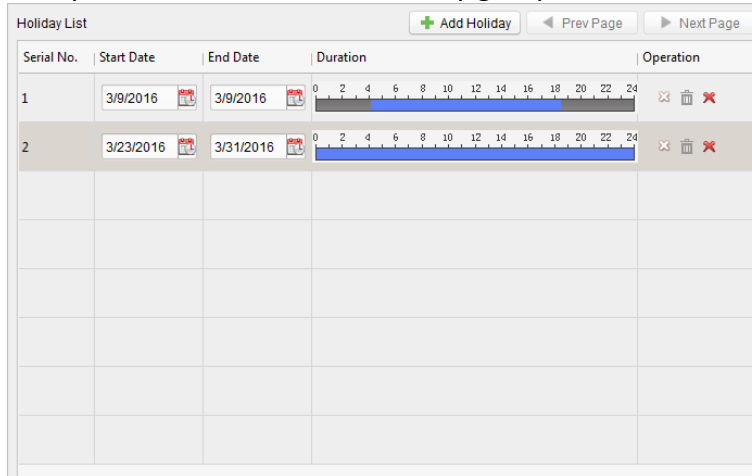

- Click **Add Holiday** icon on the right to add a holiday period to the holiday list and configure the duration of the holiday.

Note: Up to 16 holidays can be added to one holiday group.



- On the period schedule, click and drag to draw the period, which means in that period of time, the configured permission is activated.

Note: Up to 8 time durations can be set for each period in the schedule.

- When the cursor turns to , you can move the selected time bar you just edited. You can also edit the displayed time point to set the accurate time period.
- When the cursor turns to , you can lengthen or shorten the selected time bar.
- Optionally, you can select the schedule time bar, and then click  to delete the selected time bar, or click  to delete all the time bars of the holiday, or click  to delete the holiday directly.

- Click **Save** to save the settings.

Note: The holidays cannot be overlapped with each other.

6.6.3 Template

After setting the week schedule and holiday group, you can configure the template which contains week schedule and holiday group schedule.

Note: The priority of holiday group schedule is higher than the week schedule.

Click **Template** tab to enter the Template Management interface.

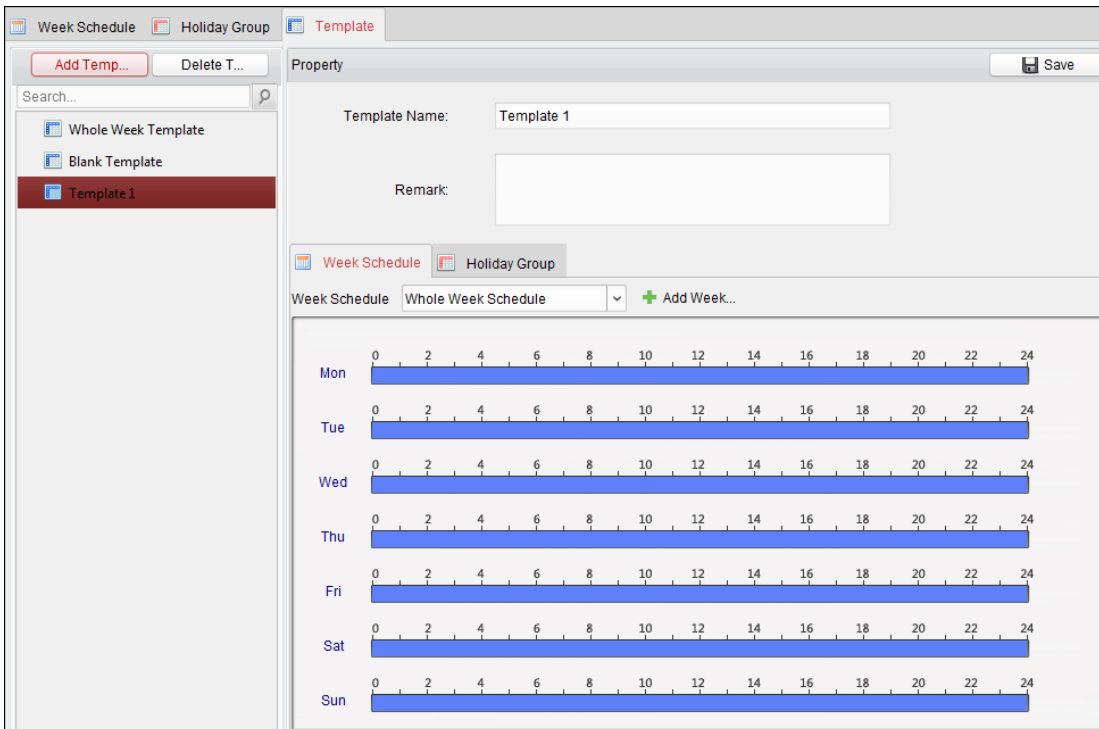

There are two pre-defined templates by default: **Whole Week Template** and **Blank Template**, which cannot be deleted and edited.

- **Whole Week Template:** The card swiping is valid on each day of the week and it has no holiday group schedule.
- **Blank Template:** The card swiping is invalid on each day of the week and it has no holiday group schedule.

You can define custom templates on your demand.

Steps:

1. Click **Add Template** to pop up the adding template interface.

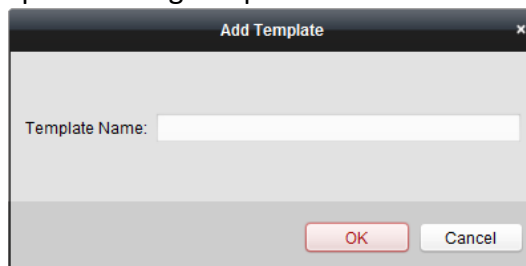

2. Input the template name in the text field and click **OK** button to add the template.
3. Select the added template and you can edit its property on the right. You can edit the template name and input the remark information.
4. Select a week schedule to apply to the schedule.
Click **Week Schedule** tab and select a schedule in the dropdown list.
You can also click **Add Week Schedule** to add a new week schedule. For details, refer to *Chapter 6.6.1 Week Schedule*.

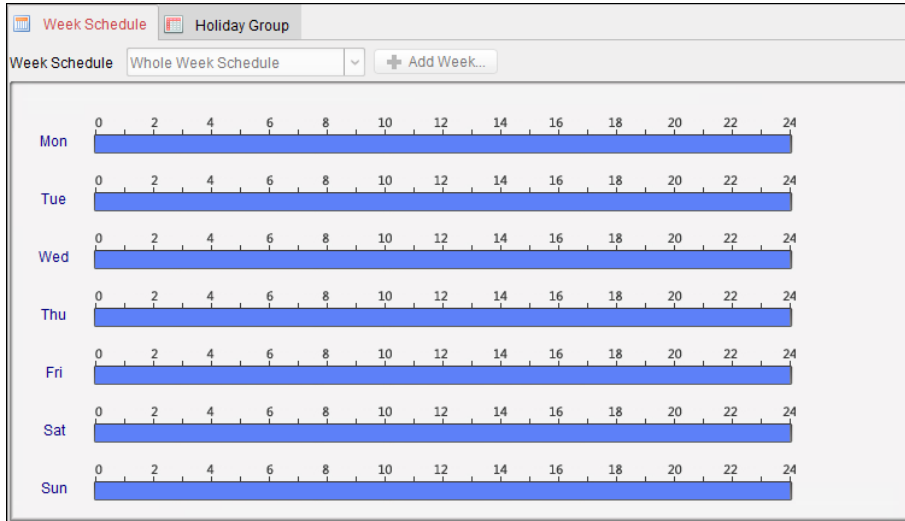

5. Select holiday groups to apply to the schedule.

Note: Up to 4 holiday groups can be added.

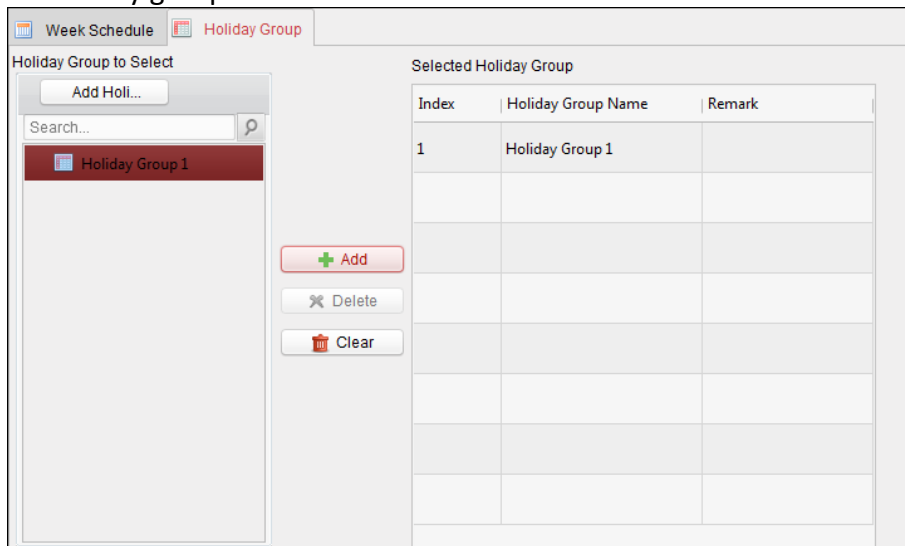

Click to select a holiday group in the list and click **Add** to add it to the template. You can also click **Add Holiday Group** to add a new one. For details, refer to *Chapter 6.6.2 Holiday Group*. You can click to select an added holiday group in the right-side list and click **Delete** to delete it. You can click **Clear** to delete all the added holiday groups.

6. Click **Save** button to save the settings.

6.7 Permission Configuration

In Permission Configuration module, you can add, edit, and delete the access control permission, and then apply the permission settings to the device to take effect.

Click  icon to enter the Access Control Permission interface.

Permission Na...	Template	Person	Door	Details	Status
Permission 1	Whole Week T...	Wendy	Floor1_10.17....	Details	Not Applied

6.7.1 Adding Permission

Purpose:

You can assign permission for persons to enter/exist the access control points (doors) in this section.

Notes:

- You can add up to 4 permissions to one access control point of one device.
- You can add up to 128 permissions in total.

Steps:

1. Click **Add** icon to enter following interface.

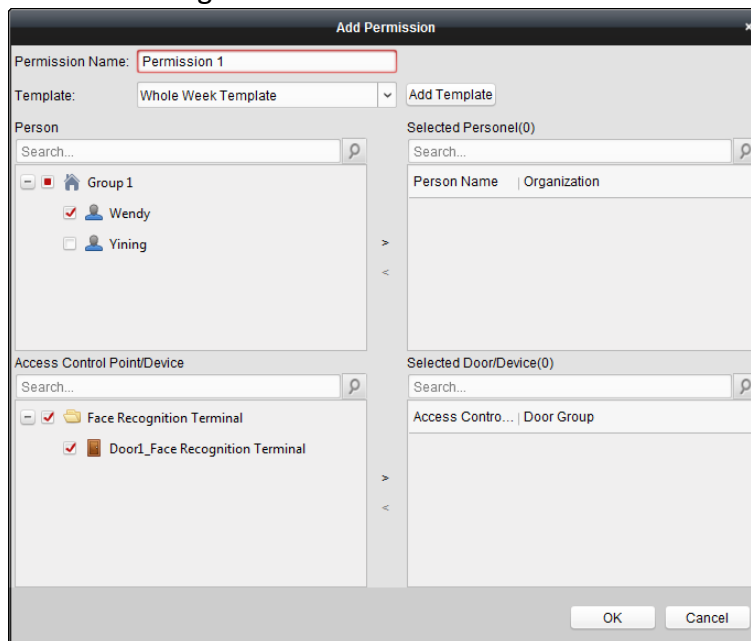

2. In the Permission Name field, input the name for the permission as desired.
3. Click on the dropdown menu to select a template for the permission.

Note: You should configure the template before permission settings. You can click **Add Template** button to add the template. Refer to *Chapter 6.6 Schedule and Template* for details.

4. In the Person list, all the added persons display. Check the checkbox(es) to select person(s) and click > to add to the Selected Person list. (Optional) You can select the person in Selected Person list and click < to cancel the selection.
5. In the Access Control Point/Device list, all the added access control points (doors) and door stations will display. Check the checkbox(es) to select door(s) or door station(s) and click > to add to the selected list.

(Optional) You can select the door or door station in the selected list and click < to cancel the selection.

6. Click **OK** button to complete the permission adding. The selected person will have the permission to enter/exit the selected door/door station with their linked card(s) or fingerprints.
7. (Optional) after adding the permission, you can click **Details** to modify it. Or you can select the permission and click **Modify** to modify.

You can select the added permission in the list and click **Delete** to delete it.

6.7.2 Applying Permission

Purpose:

After configuring the permissions, you should apply the added permission to the access control device to take effect.

Steps:

1. Select the permission(s) to apply to the access control device.
To select multiple permissions, you can hold the *Ctrl* or *Shift* key and select permissions.
2. Click **Apply All** to start applying all the selected permission(s) to the access control device or door station.
You can also click **Apply Changes** to apply the changed part of the selected permission(s) to the device(s).
3. The following window will pop up, indicating the applying permission result.

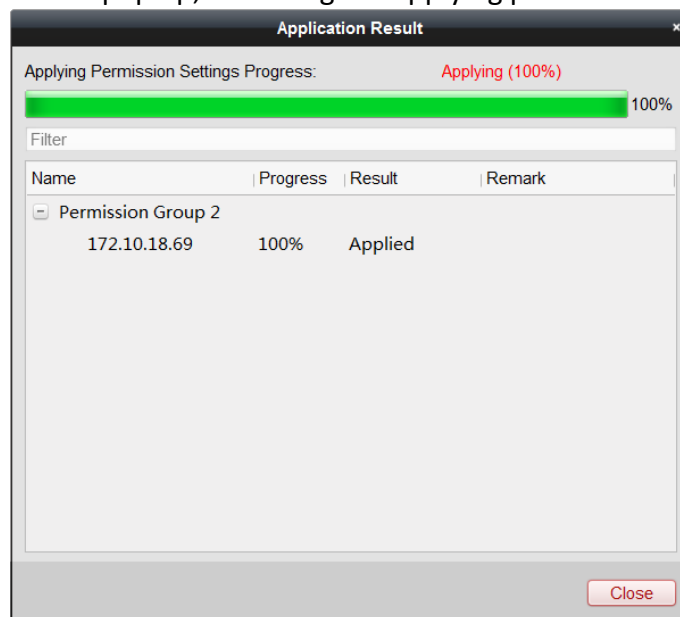

Notes:

- When the permission settings are changed, the following hint box will pop up.

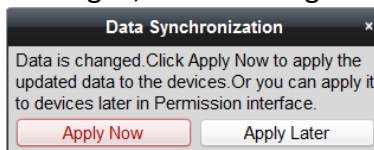

You can click **Apply Now** to apply the changed permissions to the device.

Or you can click **Apply Later** to apply the changes later in the Permission interface.

- The permission changes include changes of schedule and template, permission settings, person's permission settings, and related person settings (including card No., fingerprint, face picture, linkage between card No. and fingerprint, linkage between card No. and fingerprint, card password, card effective period, etc).

6.8 Advanced Functions

Purpose:

After configuring the person, template, and access control permission, you can configure the advanced functions of access control application, such as access control parameters, authentication password, and opening door with first card, anti-passing back, etc.

Note: The advanced functions should be supported by the device.

Click  icon to enter the following interface.

6.8.1 Access Control Parameters

Purpose:

After adding the access control device, you can configure its access control point (door)'s parameters, and its card readers' parameters.

Click **Access Control Parameters** tab to enter the parameters settings interface.

Door Parameters

Steps:

1. In the controller list on the left, click  to expand the access control device, select the door (access control point) and you can edit the information of the selected door on the right.

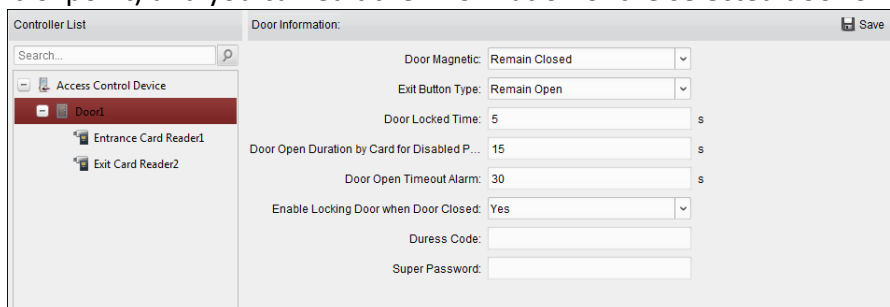

2. You can editing the following parameters:
 - **Door Magnetic:** The Door Magnetic is in the status of **Remain Closed** (excluding special conditions).
 - **Exit Button Type:** The Exit Button Type is in the status of **Remain Open** (excluding special conditions).
 - **Door Locked Time:** After swiping the normal card and relay action, the timer for locking the door starts working.
 - **Door Open Duration by Card for Disabled Person:** The door magnetic can be enabled with appropriate delay after disabled person swipes the card.
 - **Door Open Timeout Alarm:** The alarm can be triggered if the door has not been closed.
 - **Enable Locking Door when Door Closed:** The door can be locked once it is closed even if the Door Locked Time is not reached.
 - **Duress Code:** The door can open by inputting the duress code when there is duress. At the same time, the client can report the duress event.
 - **Super Password:** The specific person can open the door by inputting the super password.

Notes:

- The duress code and the super code should be different.
- The duress code and the super password should contain 4 to 8 numerics.

3. Click **Save** button to save parameters.

Card Reader Parameters

Steps:

1. In the device list on the left, click  to expand the door, select the card reader name and you can edit the card reader parameters on the right.

Basic Information	
Nickname:	Entrance Card Reader1
Enable Card Reader:	Yes
OK LED Polarity:	Anode
Error LED Polarity:	Anode
Buzzer Polarity:	Anode
Minimum Card Swiping Interval:	0 s
Max. Interval When Inputting Password:	10 s
Enable Failed Attempts Limit of Card Reading:	No
Max. Times of Card Swiping Failure:	5
Enable Tampering Detection:	No
Detect When Card Reader is Offline for:	0 s
Buzzing Time:	10 s
Card Reader Type:	Fingerprint+Face
Card Reader Description:	XXXXXX
Fingerprint Information	
Fingerprint Security Level:	1/100000False Acceptance Rate ...
Face Picture Information	
Score:	50
Face Recognition Timeout Value:	3s
Face Recognition Interval:	
1:1 Match Threshold:	75
1:N Match Threshold:	90
Live Face Detection:	Enable
Live Face Detection Security Level:	Medium
Application Mode:	Indoor

2. You can edit the following parameters:

- **Nickname:** Edit the card reader name as desired.
- **Enable Card Reader:** Select **Yes** to enable the card reader.
- **OK LED Polarity:** Select the OK LED Polarity of the card reader mainboard.
- **Error LED Polarity:** Select the Error LED Polarity of the card reader mainboard.
- **Buzzer Polarity:** Select the Buzzer LED Polarity of the card reader mainboard.
- **Minimum Card Swiping Interval:** If the interval between card swiping of the same card is less than the set value, the card swiping is invalid. You can set it as 0 to 255.
- **Max. Interval When Inputting Password:** When you inputting the password on the card reader, if the interval between pressing two digits is larger than the set value, the digits you pressed before will be cleared automatically.
- **Enable Failed Attempts Limit of Card Reading:** Enable to report alarm when the card reading attempts reach the set value.
- **Max. Times of Card Swiping Failure:** Set the max. failure attempts of reading card.
- **Enable Tampering Detection:** Enable the anti-tamper detection for the card reader.
- **Detect When Card Reader is Offline for:** When the access control device cannot connect with the card reader for longer than the set time, the card reader will turn offline automatically.
- **Buzzing Time:** Set the card reader buzzing time. The available time ranges from 0 to 5999s. 0 represents continuous buzzing.
- **Card Reader Type:** Get the card reader's type.
- **Card Reader Description:** Get the card reader description.

- **Fingerprint Security Level:** Select the fingerprint recognition level from the drop-down list.
- **Score:** The device will score the captured picture according to the yaw angle, pitch angle, and pupillary distance. If the score is less than the configured value, face recognition is failed.
- **Face Recognition Timeout Value:** If the recognition time is more than the configured time, the device will remind you.
- **Face Recognition Interval:** The time interval between two continuous face recognitions when authenticating. By default, the value is 0.
- **1:1 Match Threshold:** Set the matching threshold when authenticating via 1:1 matching mode. The larger the value, the smaller the false accept rate and the larger the false rejection rate when authentication. By default, the value is 60.
- **1:N Match Threshold:** Set the matching security level when authenticating via 1:N matching mode. The larger the value, the smaller the false accept rate and the larger the false rejection rate when authentication. By default, the value is 60.
- **Live Face Detection:** Enable or disable the live face detection function. If enabling the function, the device can recognize whether the person is a live one or not.
Note: Biometric recognition products are not 100% applicable to anti-spoofing environments. If you require a higher security level, use multiple authentication modes.
- **Live Face Detection Security Level:** After enabling Live Face Detection function, you can set the matching security level when performing live face authentication.
- **Application Mode:** You can select either others or indoor according to actual environment.

6.8.2 Card Reader Authentication



Purpose:

You can set the passing rules for the card reader of the access control device.

Steps:

1. Click **Card Reader Authentication** tab and select a card reader on the left.
2. Click **Configuration** button to select the card reader authentication modes for setting the schedule.

Notes:

- The available authentication modes depend on the device type.
 - Password refers to the card password set when issuing the card to the person in *Chapter 6.5 Person Management*.
- 1) Select the modes and click  to add to the selected modes list.
You can click  or  to adjust the display order.

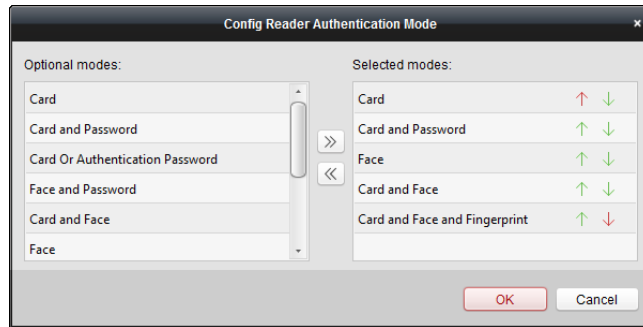

- 2) Click **OK** to confirm the selection.
3. After selecting the modes, the selected modes will display as icons. Click the icon to select a card reader authentication mode.
4. Click and drag your mouse on a day to draw a color bar on the schedule, which means in that period of time, the card reader authentication is valid.

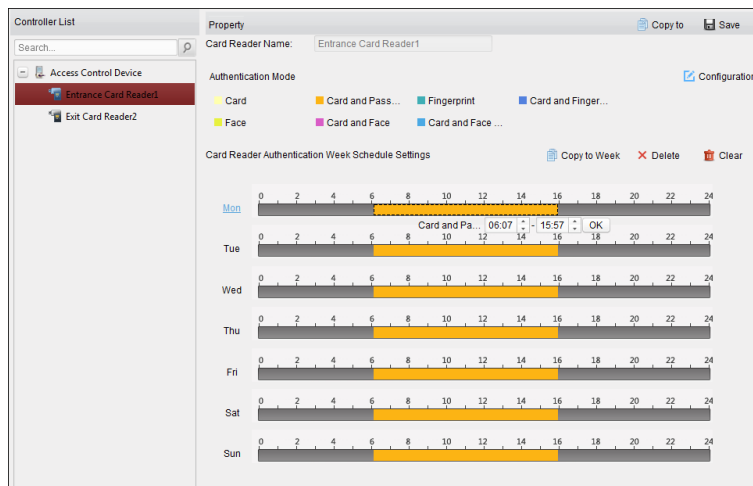

5. Repeat the above step to set other time periods.
Or you can select a configured day and click **Copy to Week** button to copy the same settings to the whole week.
(Optional) You can click **Delete** button to delete the selected time period or click **Clear** button to delete all the configured time periods.
6. (Optional) Click **Copy to** button to copy the settings to other card readers.

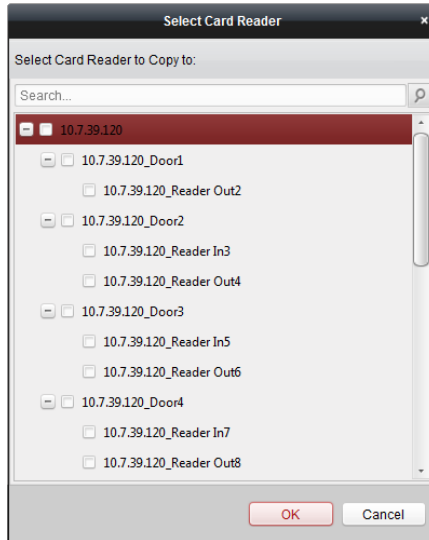

7. Click **Save** button to save parameters.

6.8.3 Multiple Authentication

Purpose:

You can manage the cards by group and set the authentication for multiple cards for one access control point (door).

Note: Please set the card permission and apply the permission setting to the access control device first. For details, refer to *Chapter 6.7 Permission Configuration*.

Steps:

1. Click **Multiple Authentication** tab to enter the following interface.

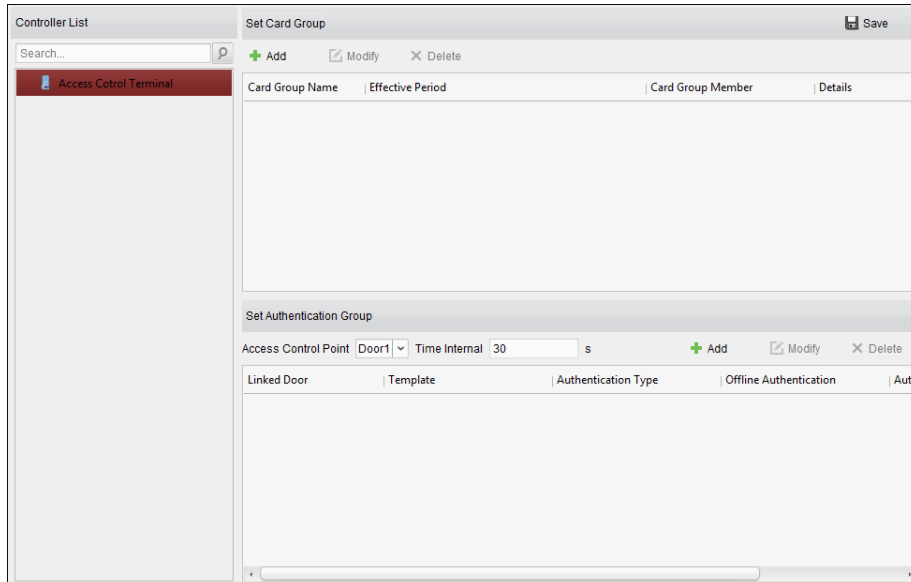

2. Select access control device from the list on the left.
3. In the Set Card Group panel on the right, click **Add** button to pop up the following dialog:

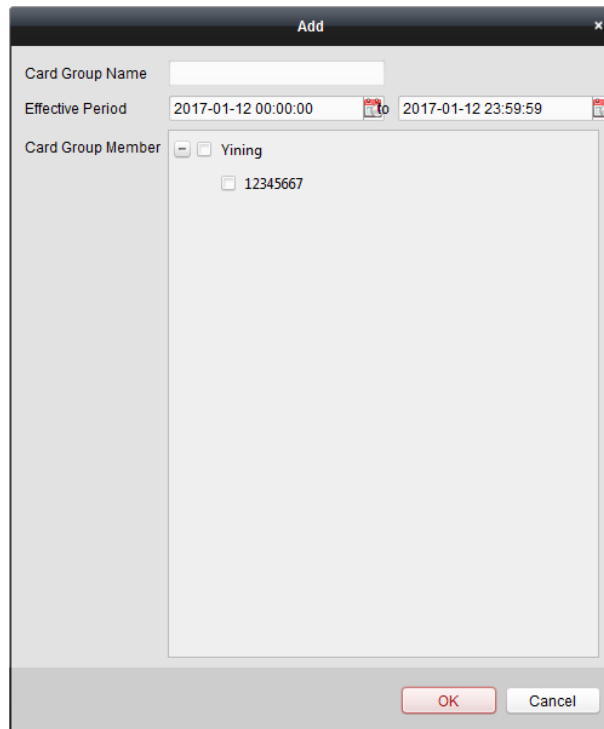

- 1) In the Card Group Name field, input the name for the group as desired.
- 2) Click  to set the effective time and expiry time of the card group.
- 3) Check the checkbox(es) to select the card(s) to add the card group.
- 4) Click **OK** to save the card group.
4. In the Set Authentication Group panel, select the access control point (door) of the device for multiple authentications.
5. Input the time interval for card swiping.
6. Click **Add** to pop up the following dialog.

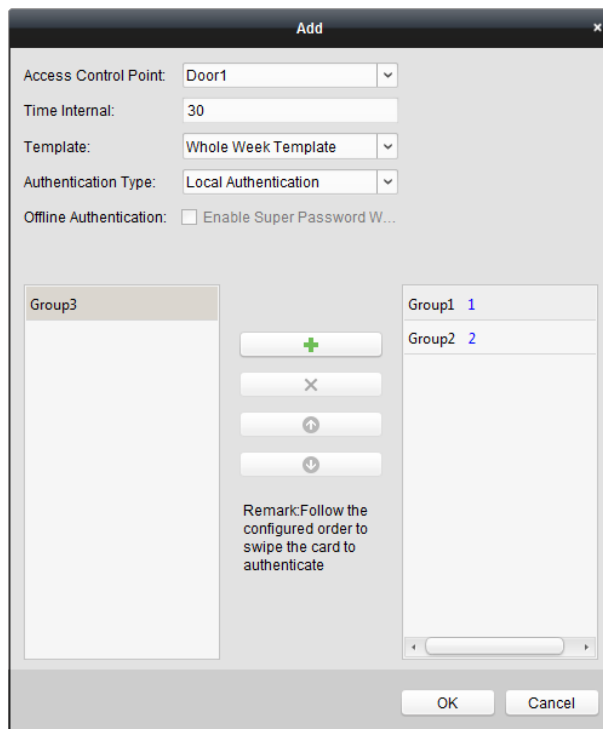

- 1) Select the template of the authentication group from the dropdown list. For details about setting the template, refer to *Chapter 6.6 Schedule and Template*.
 - 2) Select the authentication type of the authentication group from the dropdown list.
 - **Local Authentication:** Authentication by the access control device.
 - **Local Authentication and Remotely Open Door:** Authentication by the access control device and by the client.
For Local Authentication and Remotely Open Door type, you can check the checkbox to enable the super password authentication when the access control device is disconnected with the client.
 - **Local Authentication and Super Password:** Authentication by the access control device and by the super password.
 - 3) In the list on the left, the added card group will display. You can click the card group and click **+** to add the group to the authentication group.
You can click the added card group and click **X** to remove it from the authentication group.
You can also click **↑** or **↓** to set the card swiping order.
 - 4) Input the **Card Swiping Times** for the selected card group.

Notes:

 - The Card Swiping Times should be larger than 0 and smaller than the added card quantity in the card group.
 - The upper limit of Card Swiping Times is 16.
 - 5) Click **OK** to save the settings.
7. Click **Save** to save and take effect of the new settings.

Notes:

- For each access control point (door), up to 20 authentication groups can be added.

- For the authentication group which certificate type is **Local Authentication**, up to 8 card groups can be added to the authentication group.
- For the authentication group which certificate type is **Local Authentication and Super Password** or **Local Authentication and Remotely Open Door**, up to 7 card groups can be added to the authentication group.

6.8.4 Open Door with First Card

Purpose:

You can set multiple first cards for one access control point. After the first card swiping, it allows multiple persons access the door or other authentication actions. The first card mode contains Remain Open with First Card and Disable Remain Open with First Card.

- **Remain Open with First Card:** The door remains open for the configured time duration after the first card swiping until the remain open duration ends.
- **Disable Remain Open with First Card:** Disable the function.

Notes:

- The first card authorization is effective only on the current day. The authorization will be expired after 24:00 on the current day.
- You can swipe the first card again to disable the first card mode.

Steps:

1. Click **Open Door with First Card** tab to enter the following interface.

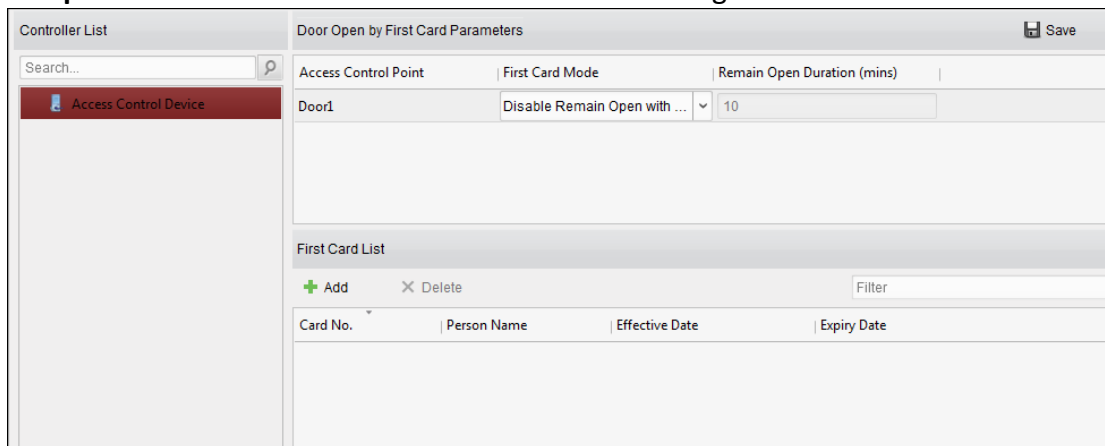

2. Select an access control device from the list on the left.
3. Select the first card mode in the drop-down list for the access control point and set the remain open duration.

Notes:

- The Remain Open Duration should be between 0 and 1440 minutes. By default, it is 10 minutes.
 - You can swipe the first card again to disable the first card mode.
4. In the First Card list, Click **Add** button to pop up the following dialog box.

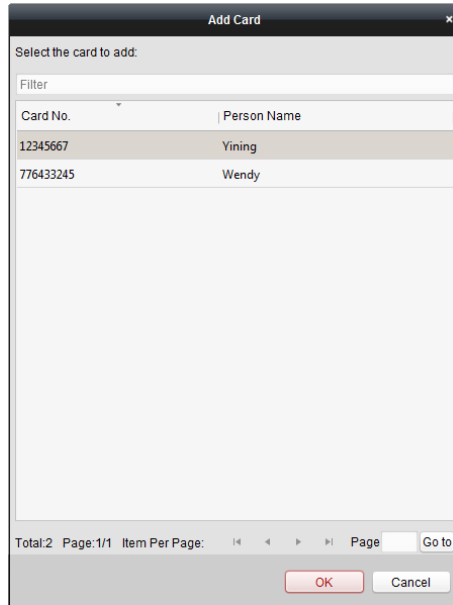

- 1) Select the cards to add as first card for the door
Note: Set the card permission and apply the permission setting to the access control device first. For details, refer to *Chapter 6.7 Permission Configuration*.
- 2) Click **OK** button to save adding the card.
5. You can click **Delete** button to remove the card from the first card list.
6. Click **Save** to save and take effect of the new settings.

6.8.5 Anti-Passing Back

Purpose:

You can set to only pass the access control point according to the specified path and only one person could pass the access control point after swiping the card.

Notes:

- Either the anti-passing back or multi-door interlocking function can be configured for an access control device at the same time.
- You should enable the anti-passing back function on the access control device first.

Steps:

1. Click **Anti-passing Back** tab to enter the following interface.

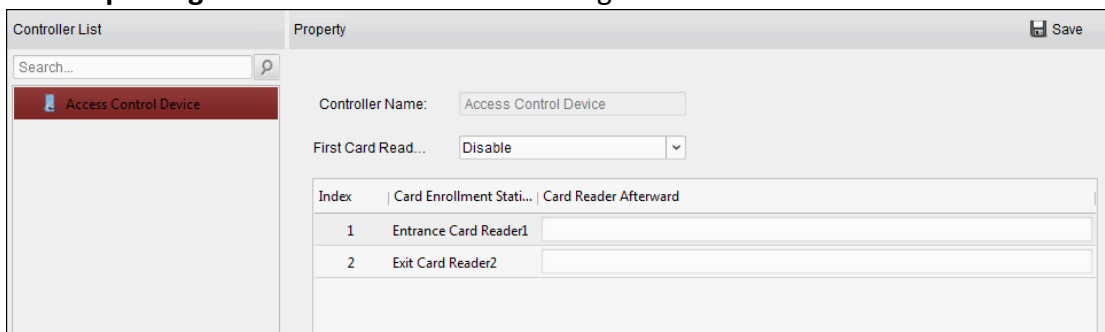

2. Select an access control device from the device list on the left.

3. In the First Card Reader field, select the card reader as the beginning of the path.
4. In the list, click the text filed of **Card Reader Afterward** and select the linked card readers.
Example: If you select Reader In_01 as the beginning, and select Reader In_02, Reader Out_04 as the linked card readers. Then you can only get through the access control point by swiping the card in the order as Reader In_01, Reader In_02 and Reader Out_04.

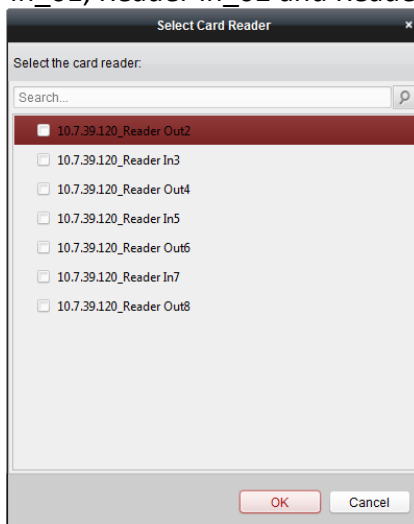

Note: Up to four afterward card readers can be added for one card reader.

5. (Optional) You can enter the Select Card Reader dialog box again to edit its afterward card readers.
6. Click **Save** to save and take effect of the new settings.

6.9 Searching Access Control Event

Purpose:

You can search the access control history events including remote event and local event via the client.

Before you start:

You should set the remote storage to view the captured face picture before searching the access control event. For details about setting remote storage, refers to *Chapter 5.1 Remote Storage* in *User Manual of iVMS-4200*.

Local Event: Search the access control event from the database of the control client.

Remote Event: Search the access control event from the device.

Click  icon and click Access Control Event tab to enter the following interface.

6.9.1 Searching Local Access Control Event

Steps:

1. Select the Event Source as **Local Event**.
2. Input the search condition according to actual needs.
3. Click **Search**. The results will be listed below.
4. For the access control event which is triggered by the card holder, you can click the event to view the card holder details, including person No., person name, organization, phone number, contact address and photo.
5. (Optional) If the event contains linked pictures, you can click in the **Capture** column to view the captured picture of the triggered camera when the alarm is triggered.
6. (Optional) If the event contains linked video, you can click in the **Playback** column to view the recorded video file of the triggered camera when the alarm is triggered.

Note: For setting the triggered camera, refer to *Chapter 6.10.1 Access Control Event Linkage*.

7. You can click **Export** to export the search result to the local PC in *.csv file.

6.9.2 Searching Remote Access Control Event

Steps:

1. Select the Event Source as **Remote Event**.
2. Input the search condition according to actual needs.

3. (Optional) You can check **With Alarm Picture** checkbox to search the events with alarm pictures.
4. Click **Search**. The results will be listed below.
5. You can click **Export** to export the search result to the local PC in *.csv file.

6.10 Access Control Event Configuration

Purpose:

For the added access control device, you can configure its access control linkage including access control event linkage, access control alarm input linkage, event card linkage, and cross-device linkage.

Click the  icon on the control panel, or click **Tool->Event Management** to open the Event Management page.

6.10.1 Access Control Event Linkage

Purpose:

You can assign linkage actions to the access control event by setting up a rule. For example, when the access control event is detected, an audible warning appears or other linkage actions happen.

Note: The linkage here refers to the linkage of the client software's own actions.

Steps:

1. Click the **Access Control Event** tab.
2. The added access control devices will display in the Access Control Device panel on the left. Select the access control device, or alarm input, or access control point (door), or card reader to configure the event linkage.
3. Select the event type to set the linkage.
4. Select the triggered camera. The image or video from the triggered camera will pop up when the selected event occurs.
To capture the picture of the triggered camera when the selected event occurs, you can also set the capture schedule and the storage in Storage Schedule.
5. Check the checkboxes to activate the linkage actions. For details, refer to *Table 14.1 Linkage Actions for Access Control Event*.
6. Click **Save** to save the settings.
7. You can click Copy to button to copy the access control event to other access control device, alarm input, access control point, or card reader.
Select the parameters for copy, select the target to copy to, and click **OK** to confirm.

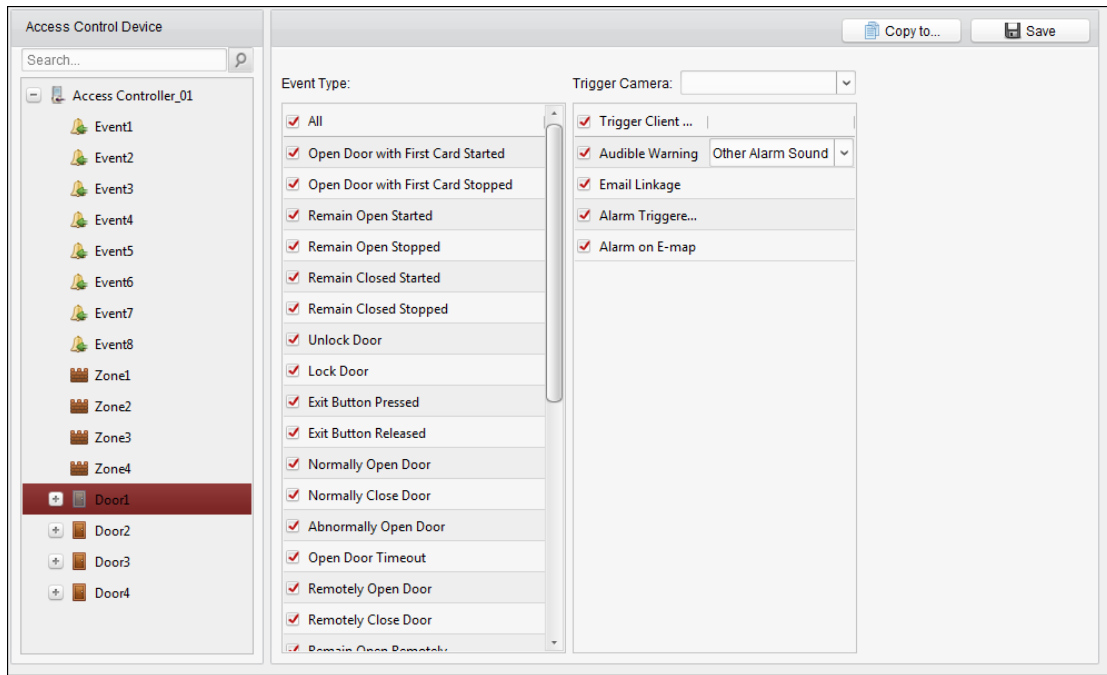

Table 1. 1 Linkage Actions for Access Control Event

Linkage Actions	Descriptions
Audible Warning	The client software gives an audible warning when alarm is triggered. You can select the alarm sound for audible warning.
Email Linkage	Send an email notification of the alarm information to one or more receivers.
Alarm on E-map	Display the alarm information on the E-map. Note: This linkage is only available to access control point and alarm input.
Alarm Triggered Pop-up Image	The image with alarm information pops up when alarm is triggered.

6.10.2 Event Card Linkage

Click **Event Card Linkage** tab to enter the following interface.

Note: The Event Card Linkage should be supported by the device.

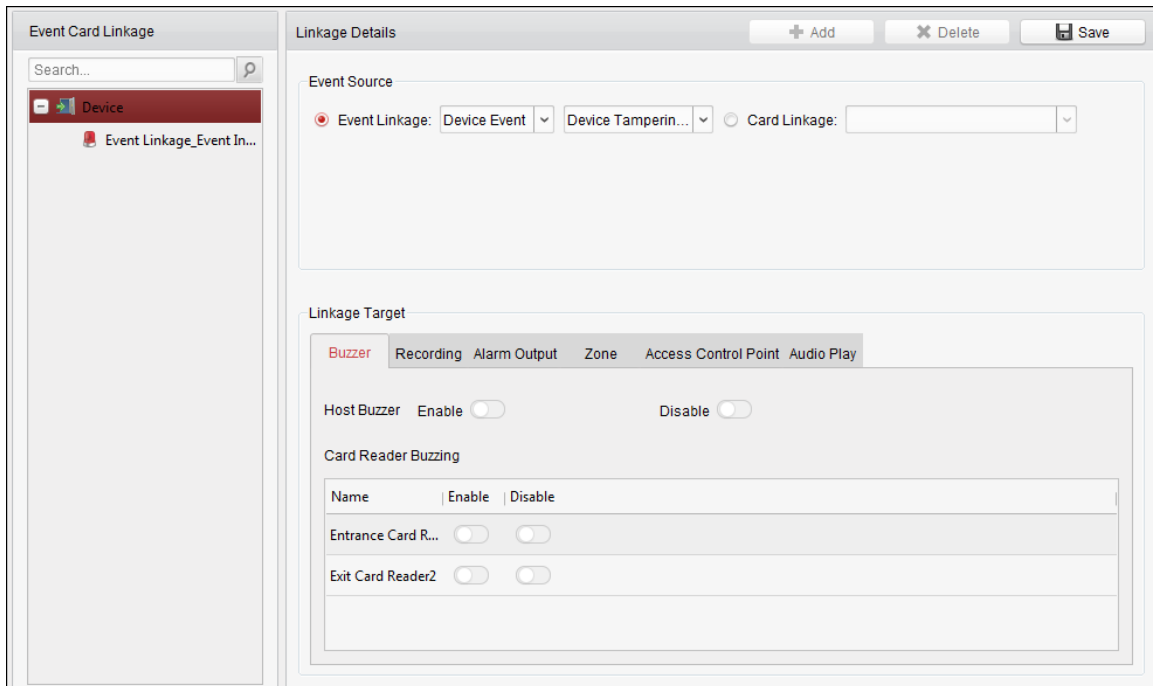

Select the access control device from the list on the left.

Click **Add** button to add a new linkage. You can select the event source as **Event Linkage** or **Card Linkage**.

Event Linkage

For the event linkage, the alarm event can be divided into four types: device event, alarm input, door event, and card reader event.

Steps:

1. Select a device on the left and click **Add**.
2. Click to select the linkage type as **Event Linkage**, and select the event type from the dropdown list.
 - For Device Event, select the detailed event type from the dropdown list.
 - For Alarm Input, select the type as alarm or alarm recovery and select the alarm input name from the panel.
 - For Door Event, select the detailed event type and select the source door from the panel.
 - For Card Reader Event, select the detailed event type and select the card reader from the panel.
3. Click different tabs to set different parameters. Switch the property from to to enable this function.

You can set the parameters of buzzer, recording, alarm output, and access control point.



Linkage Type	Linkage Target	Descriptions
Buzzer	Host Buzzer	The audible warning of controller will be triggered.
	Card Reader Buzing	The audible warning of card reader will be triggered.
Recording	Capture Status	The real-time capture will be triggered.
Alarm Output	Alarm Output	The alarm output will be triggered for notification.

Access Control Point	Access Control Point	<p>The door status of open, close, remain open, and remain closed will be triggered.</p> <p>Notes:</p> <ul style="list-style-type: none"> ● The door status of open, close, remain open, and remain close cannot be triggered at the same time. ● The target door and the source door cannot be the same one.
----------------------	----------------------	--

4. Click **Save** to save and take effect of the parameters.

Card Linkage

Steps:

1. Click to select the linkage type as **Card Linkage**.
2. Input the card No. or select the card from the dropdown list.
3. Select the card reader from the panel for triggering.
5. Click different tabs to set different parameters. Switch the property from  to  to enable this function.

You can set the parameters of buzzer, recording, alarm output, and access control point.

Linkage Type	Linkage Target	Descriptions
Buzzer	Host Buzzer	The audible warning of controller will be triggered.
	Card Reader Buzzing	The audible warning of card reader will be triggered.
Recording	Capture Status	The real-time capture will be triggered.
Alarm Output	Alarm Output	The alarm output will be triggered for notification.
Access Control Point	Access Control Point	<p>The door status of open, close, remain open, and remain closed will be triggered.</p> <p>Notes:</p> <ul style="list-style-type: none"> ● The door status of open, close, remain open, and remain close cannot be triggered at the same time. ● The target door and the source door cannot be the same one.

4. Click **Save** to save and take effect of the parameters.

6.10.3 Cross-Device Linkage

Purpose:

You can assign to trigger other access control device's action by setting up a rule when the access control event is triggered.

Click **Cross-Device Linkage** tab to enter the following interface.

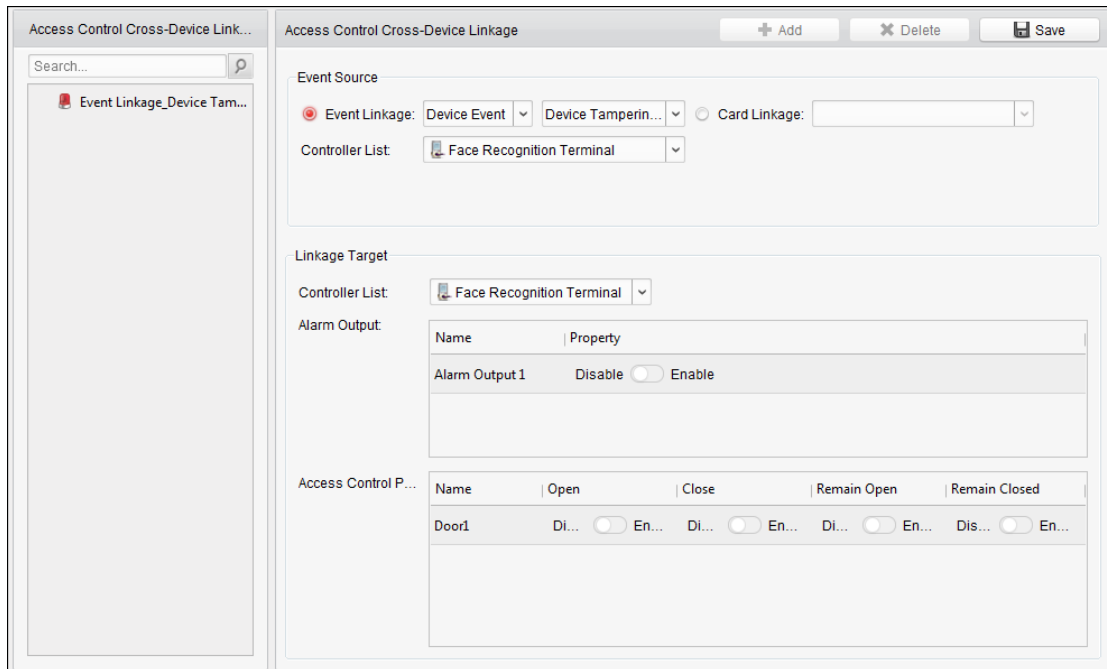

Click **Add** button to add a new client linkage. You can select the event source as **Event Linkage** or **Card Linkage**.

Event Linkage

For the event linkage, the alarm event can be divided into four types: device event, alarm input, door event, and card reader event.

Steps:

1. Click to select the linkage type as **Event Linkage**, select the access control device as event source, and select the event type from the dropdown list.
 - For Device Event, select the detailed event type from the dropdown list.
 - For Alarm Input, select the type as alarm or alarm recovery and select the alarm input name from the table.
 - For Door Event, select the detailed event type and select the door from the table.
 - For Card Reader Event, select the detailed event type and select the card reader from the table.
2. Set the linkage target, select the access control device from the dropdown list as the linkage target, and switch the property from to to enable this function.
 - **Alarm Output:** The alarm output will be triggered for notification.
 - **Access Control Point:** The door status of open, close, remain open, and remain close will be triggered.

Note: The door status of open, close, remain open, and remain close cannot be triggered at the same time.
3. Click **Save** button to save parameters.

Card Linkage

Steps:

1. Click to select the linkage type as **Card Linkage**.
2. Select the card from the dropdown list and select the access control device as event source.
3. Select the card reader from the table for triggering.
4. Set the linkage target, select the access control device from the dropdown list as the linkage target, and switch the property from to to enable this function.
Alarm Output: The alarm output will be triggered for notification.
5. Click **Save** button to save parameters.

6.11 Door Status Management

Purpose:

The door status of the added access control device will be displayed in real time. You can check the door status and the linked event(s) of the selected door. You can control the status of the door and set the status duration of the doors as well.

6.11.4 Access Control Group Management

Purpose:

Before controlling the door status and setting the status duration, you are required to organize it into group for convenient management.

Perform the following steps to create the group for the access control device:

Steps:

1. Click  on the control panel to open the Device Management page.
2. Click **Group** tab to enter the Group Management interface.

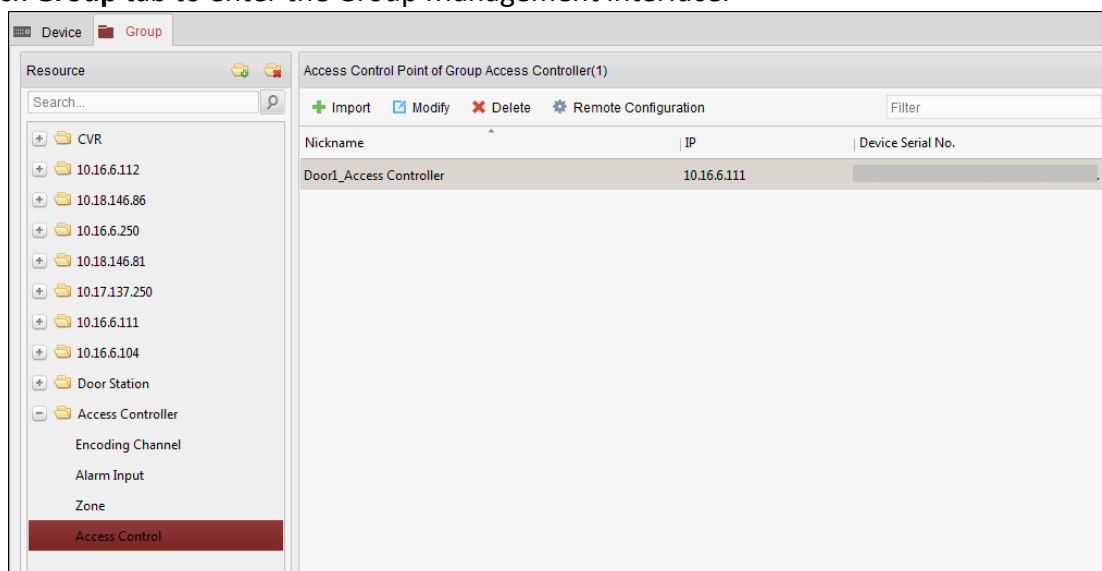

3. Perform the following steps to add the group.
 - 1) Click  to open the Add Group dialog box.
 - 2) Input a group name as you want.
 - 3) Click **OK** to add the new group to the group list.

You can also check the checkbox **Create Group by Device Name** to create the new group by the name of the selected device.

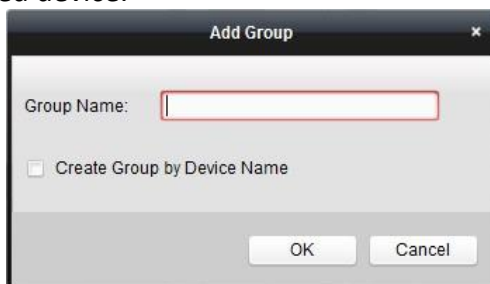

4. Perform the following steps to import the access control points to the group:
 - 1) Click **Import** on Group Management interface, and then click the **Access Control** tab to open the Import Access Control page.

Notes:

- You can also select **Alarm Input** tab and import the alarm inputs to group.
 - For the Video Access Control Terminal, you can add the cameras as encoding channel to the group.
- 2) Select the names of the access control points in the list.
 - 3) Select a group from the group list.
 - 4) Click **Import** to import the selected access control points to the group.
You can also click **Import All** to import all the access control points to a selected group.

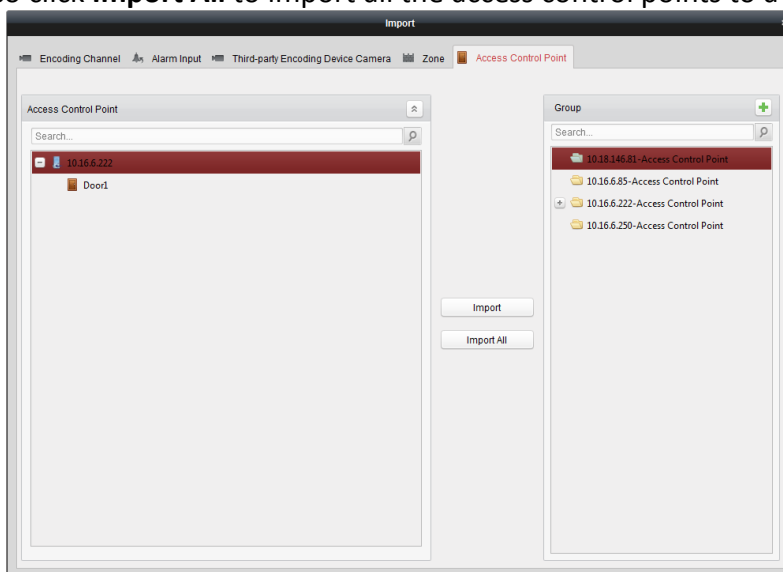

5. After importing the access control points to the group, you can click , or double-click the group/access control point name to modify it.

6.11.5 Anti-control the Access Control Point (Door)

Purpose:

You can control the status for a single access control point (a door), including opening door, closing door, remaining open, and remaining closed.



Click icon on the control panel to enter the Status Monitor interface.

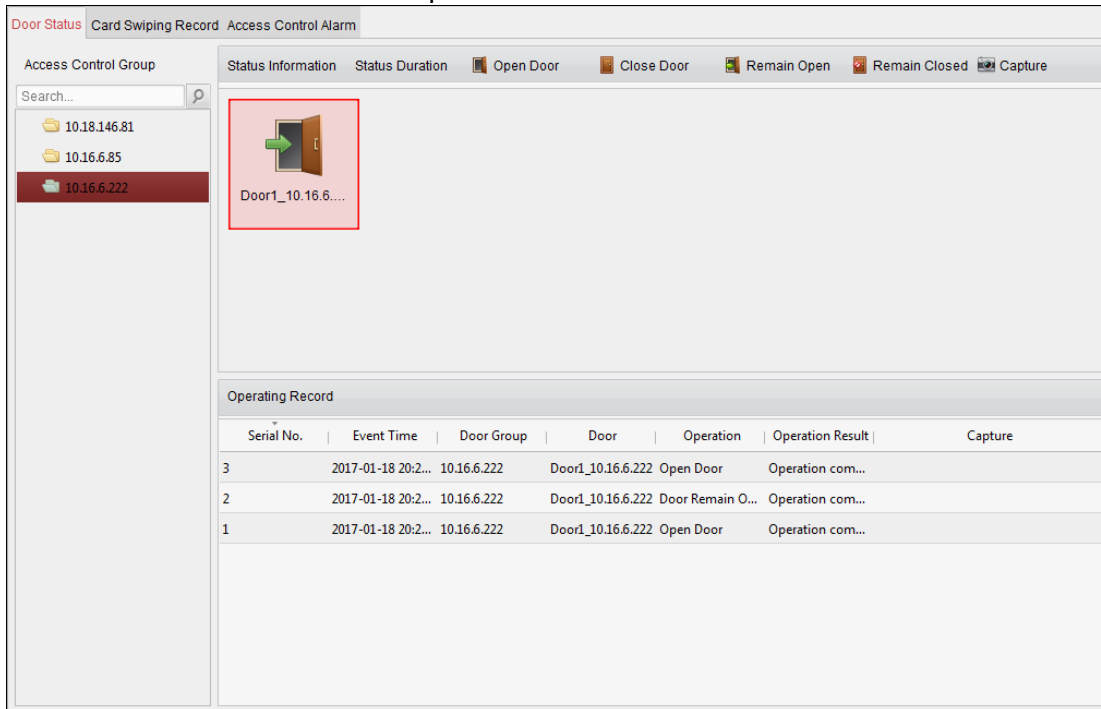

Steps:

1. Select an access control group on the left. For managing the access control group, refer to *Chapter 6.11.4 Access Control Group Management*.
2. The access control points of the selected access control group will be displayed on the right.



Click icon on the Status Information panel to select a door.

3. Click the following button listed on the **Status Information** panel to control the door.

- Open Door** : Click to open the door once.
- Close Door** : Click to close the door once.
- Remain Open** : Click to keep the door open.
- Remain Closed** : Click to keep the door closed.
- Capture** : Click to capture the picture manually.

4. You can view the anti-control operation result in the Operation Log panel.

Notes:

- If you select the status as **Remain Open/Remain Closed**, the door will keep open/closed until a new anti-control command being made.
- The **Capture** button is available when the device supports capture function. And it cannot be realized until the storage server is configured.
- If the door is in remain closed status, only super card can open the door or open door via the client software.

6.11.6 Status Duration Configuration

Purpose:

You can schedule weekly time periods for an access control point (door) to remain open or remain closed.

In the Door Status module, click **Status Duration** button to enter the Status Duration interface.

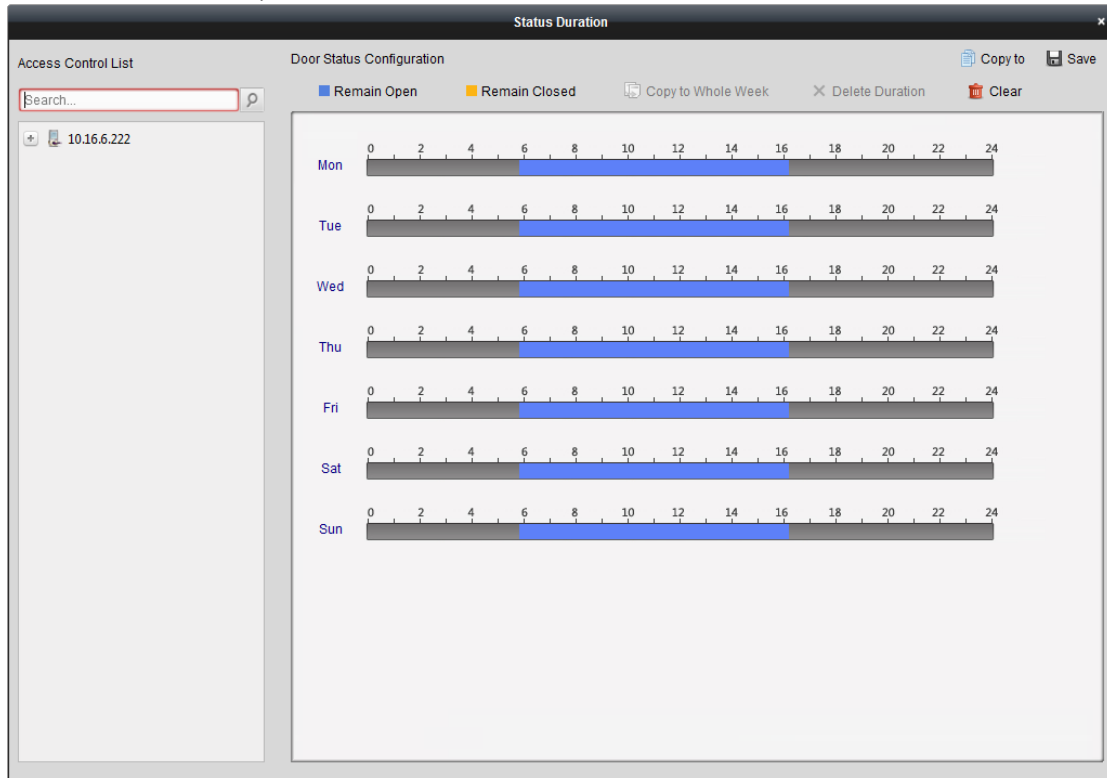

Steps:

1. Click to select a door from the access control device list on the left.
2. On the Door Status Configuration panel on the right, draw a schedule for the selected door.
 - 1) Select a door status brush as Remain Open or Remain Closed.

Remain Open: The door will keep open during the configured time period. The brush is marked as ■.

Remain Closed: The door will keep closed during the configured duration. The brush is marked as ■.
 - 2) Click and drag on the timeline to draw a color bar on the schedule to set the duration.



3) When the cursor turns to , you can move the selected time bar you just edited. You can also edit the displayed time point to set the accurate time period.

When the cursor turns to , you can lengthen or shorten the selected time bar.

3. Optionally, you can select the schedule time bar and click **Copy to Whole Week** to copy the time bar settings to the other days in the week.
4. You can select the time bar and click **Delete Duration** to delete the time period.
Or you can click **Clear** to clear all configured durations on the schedule.
5. Click **Save** to save the settings.
6. You can click **Copy to** button to copy the schedule to other doors.

6.11.7 Real-time Card Swiping Record

Click **Card Swiping Record** tab to enter the following interface.

The screenshot displays a software interface with three tabs at the top: 'Door Status', 'Card Swiping Record', and 'Access Control Alarm'. The 'Access Control Alarm' tab is active. Below the tabs is a table with columns: 'Card No.', 'Person Name', 'Organization', 'Event Time', 'Door Position', 'Direction', and 'Operation'. The table area is currently empty. To the right of the table is a sidebar titled 'Card Holder Information'. It features a placeholder image of a person's head and shoulders. Below the image are several input fields with labels: 'Person No.', 'Person Name', 'Gender', 'ID Type', 'ID No.', 'Organization', 'Phone No.', 'Address', and 'Email'.

The logs of card swiping records of all access control devices will display in real time. You can view the details of the card swiping event, including card No., person name, organization, event time, etc.

You can also click the event to view the card holder details, including person No., person name, organization, phone, contact address, etc.

6.11.8 Real-time Access Control Alarm

Purpose:

The logs of access control events will be displayed in real time, including device exception, door event, card reader event, and alarm input.

Click **Access Control Alarm** tab to enter the following interface.

Alarm Type	Alarm Time	Alarm Location	Alarm Content	Operation
Remote: Disarm...	2016-12-16 13:5...	Access Controller	Remote: Disarm...	
Remote: Arming	2016-12-16 13:5...	Access Controller	Remote: Arming	
Remote: Login	2016-12-16 13:5...	Access Controller	Remote: Login	
Remote: Disarm...	2016-12-16 13:5...	Access Controller	Remote: Disarm...	
Remote: Logout	2016-12-16 13:5...	Access Controller	Remote: Logout	
Remote: Login	2016-12-16 13:5...	Access Controller	Remote: Login	
Remote: Arming	2016-12-16 13:4...	Access Controller	Remote: Arming	
Remote: Login	2016-12-16 13:4...	Access Controller	Remote: Login	
Remote: Disarm...	2016-12-16 13:4...	Access Controller	Remote: Disarm...	
Door Locked	2016-12-16 13:4...	Door1	Door Locked	
Unlock	2016-12-16 13:4...	Door1	Unlock	
Remote: Arming	2016-12-16 13:4...	Access Controller	Remote: Arming	
Remote: Login	2016-12-16 13:4...	Access Controller	Remote: Login	
Remote: Disarm...	2016-12-16 13:4...	Access Controller	Remote: Disarm...	

Steps:

1. All access control alarms will display in the list in real time.
You can view the alarm type, alarm time, location, etc.
 2. Click to view the alarm on E-map.
 3. You can click or to view the live view or the captured picture of the triggered camera when the alarm is triggered.
- Note:** For setting the triggered camera, refer to *Chapter 6.10.1 Access Control Event Linkage*.
4. Click **Subscribe** to select the alarm that the client can receive when the alarm is triggered.

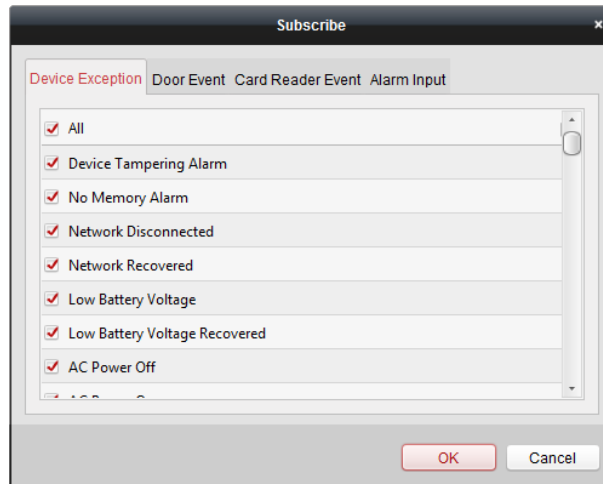

- 1) Check the checkbox(es) to select the alarm(s), including device exception alarm, door event alarm, card reader alarm, and alarm input.
- 2) Click **OK** to save the settings.

6.12 Live View

For the surveillance task, you can view the live video of the added device. And some basic operations are supported, including picture capturing, manual recording, etc.

Before you start:

A camera group is required to be defined for live view.

You can set the rotate type if necessary in the Group Management. For details, refer to *User Manual of iVMS-4200 Client Software*.

6.12.1 Starting and Stopping Live View

Starting the Live View



Steps:

1. Click the  icon on the control panel.
Or click **View->Main View** to open the Main View page.
2. Drag the camera to the display window.
Or double-click the camera name after selecting the display window to start the live view.

Note: You can drag the video of the camera in live view to another display window if needed.

Stopping the Live View

Steps:

1. Select the display window.
2. Click the icon  that appears in the upper-right corner when the mouse pointer is over the display window,
or click **Stop Live View** on the right-click menu to stop the live view of the display window.
You can also click the button  in live view toolbar to stop all the live view.





6.12.2 Manual Recording and Capture

Manual Recording in Live View

Purpose:

Manual Recording function allows you to record the live video on the Main View page manually and the video files are stored in the local PC.

Steps:

1. Move the mouse pointer to the display window in live view to show the toolbar.
2. Click  in the toolbar of the display window or on the right-click Live View Management Menu to start the manual recording. The icon  turns to .
3. Click the icon  to stop the manual recording.

A prompt box with the saving path of the video files you just recorded will pop up if all the operations succeed.

Notes:

- During the manual recording, an indicator  appears in the upper-right corner of the display window.
- The saving path of video files can be set on the System Configuration interface. For details, refer to *User Manual of iVMS-4200 Client Software*.

Viewing Local Video Files

Steps:

1. Click **File->Open Video File** to open the Video Files page.
2. Select the camera to be searched from the Camera Group list.
3. Click the icon  to specify the start time and end time for the search.
4. Click **Search**. The video files recorded between the start time and end time will be displayed. Select the video file, and click **Delete**. You can delete the video file. Select the video file, and click **Send Email**. You can send an Email notification with the selected video file attached. Select the video file, and click **Save as**. You can save a new copy of the video file.



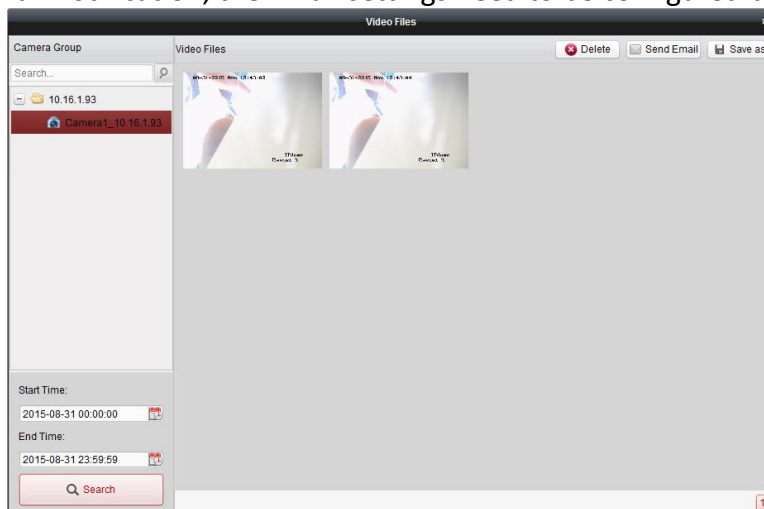







Note: To send an Email notification, the Email settings need to be configured before proceeding.



Double-click the video file and the video file can be played back locally.



The following buttons are available on the local playback page:

	CIF/4CIF	Display the video in cif/4cif resolution.
	Full Screen	Display the local playback page in full screen mode.
	Close	Close the local playback page of the video files.
	Pause/Play	Pause/Start the playback of the video files.
	Stop	Stop the playback of the video files.
	Speed	Set the playback speed.
	Single Frame	Play back the video files frame by frame.
	Digital Zoom	Enable the digital zoom function. Click again to disable.
	Enable/Disable Audio	Click to enable/disable the audio in the local playback.
	Capture	Capture the picture in the playback process.

Capturing Picture in Live View

Steps:

1. Move the mouse pointer to the display window in live view to show the toolbar.
2. Click the icon  in the toolbar of the display window or on the right-click Live View Management Menu.

A small window of the captured picture will be displayed to notify whether the capturing operation is done or not.

Note: The saving path of the captured pictures can be set on the System Configuration interface. For details, refer to *User Manual of iVMS-4200 Client Software*.

Viewing Captured Pictures

The pictures captured in live view are stored in the PC running the software. You can view the captured pictures if needed.

Steps:

1. Click **File->Open Image File** to open the Captured Images page.
2. Select the camera to be searched from the Camera Group list.
3. Click the icon  to specify the start time and end time for the search.
4. Click **Search**. The pictures captured between the start time and end time will be displayed.
5. Double-click the captured picture to enlarge it for a better view.
 - Select the captured picture, and click **Print**. You can print the selected picture.
 - Select the captured picture, and click **Delete**. You can delete the selected picture.
 - Select the captured picture, and click **Send Email**. You can send an Email notification with the selected picture attached.
 - Select the captured picture, and click **Save as**. You can save a new copy of the selected picture.

6.12.3 Other Functions in Live View

There are some other functions supported in the live view, including, two-way audio, camera

status, synchronization, etc.

Two-way Audio

Two-way audio function enables the voice talk of the camera. You can get not only the live video but also the real-time audio from the camera. If the device has multiple two-way audio channels, you can select the channel to start two-way audio.

The two-way audio can be used for only one camera at one time.

Note: Hik-Connect device doesn't support selecting channel during two-way audio.

Camera Status

The camera status, such as recording status, signal status, connection number, etc., can be detected and displayed for check. The status information refreshes every 10 seconds.

Synchronization

The synchronization function provides a way to synchronize the device clock with the PC which runs the client software.

6.12.4 Controlling Door During Live View

Purpose:

You can control the door during live view.

Steps:

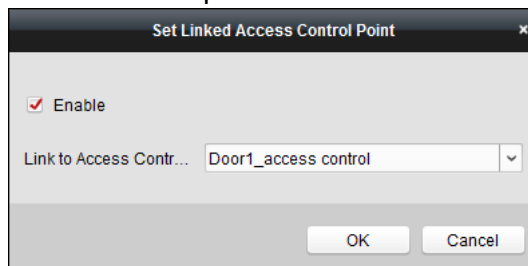

1. Right click on the live view window to pop up the right-click menu.
2. Click **Link to Access Control Point** to pop up the Set Linked Access Control Point dialog.
3. Check the **Enable** checkbox to enable the linkage function.
4. Select access control point from the dropdown list.



5. Click **OK** to save the settings.
You can also click **Cancel** to cancel the operation.
6. Get the stream again (double-click the camera) to make the settings effective.
Four door control buttons will appear on the toolbar during live view.



The following table shows the descriptions of the four buttons.

Button	Description
	Open the door.
	Close the door.
	Remain open.

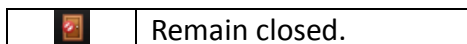

7. Click to open or close the door.

Or click to set the door status as remain open or remain closed.

Note: One camera can be linked to only one access control point; Different cameras can be linked to the same access control point.

6.13 Arming Control

Purpose:

You can arm or disarm the device. After arming the device , the client can receive the alarm information from the device.

Steps:

1. Click **Tool->Device Arming Control** to pop up the Device Arming Control window.
2. Arm the device by checking the corresponding checkbox.

Then the alarm information will be auto uploaded to the client software when alarm occurs.

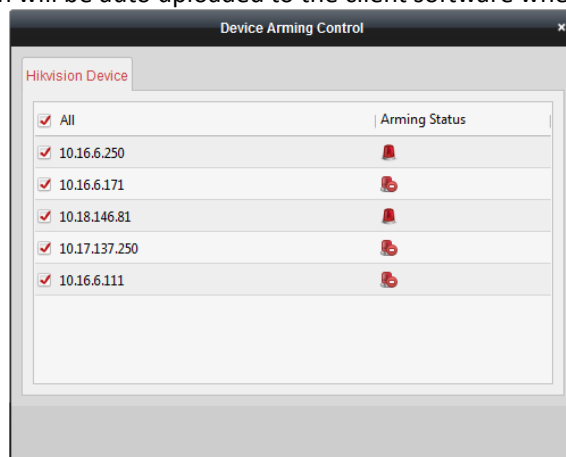

6.14 Time and Attendance

Purpose:

The Time and Attendance module provides multiple functionalities, including shift schedule management, attendance handling, attendance statistics and other advanced functions.

Before you start:

You should add organization and person in Access Control module. For details, refer to *Chapter 6.4.1 Adding Organization* and *Chapter 6.5.1 Adding Person*.

Perform the following steps to access the Time and Attendance module.



Click to enter the Time and Attendance module as follows:

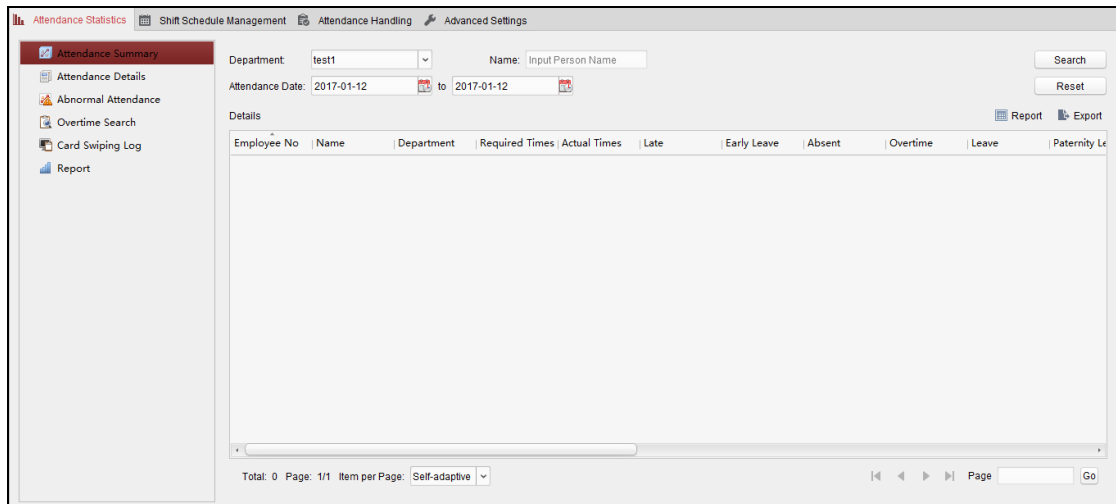

6.14.1 Shift Schedule Management

Open Time and Attendance module and click **Shift Schedule Management** to enter the Shift Schedule Management interface.

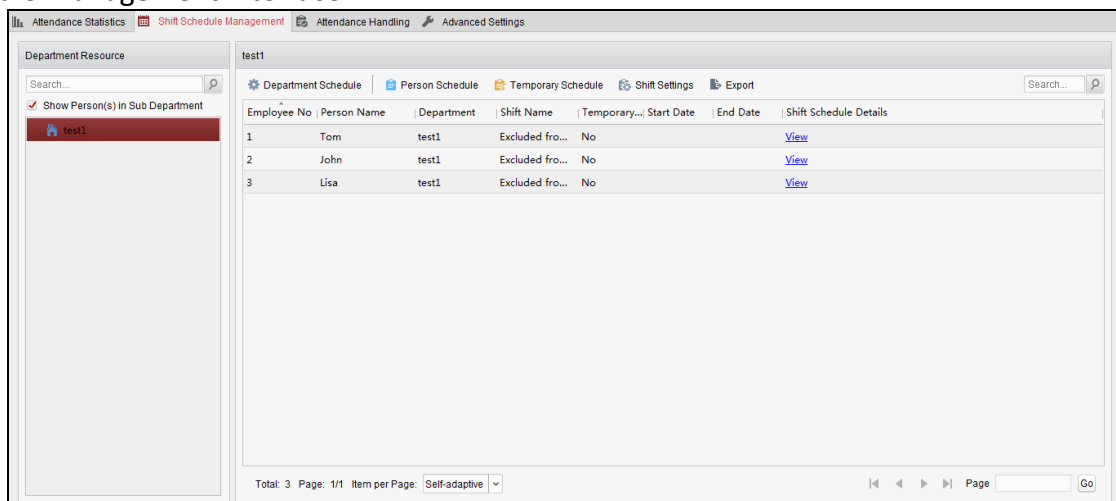

Shift Settings

Purpose:

You can add time period and shift for the shift schedule.
Click **Shift Settings** to pop up Shift Settings dialog.

➤ **Adding Time Period**

Steps:

1. Click **Time Period** tab.
2. Click **Add**.

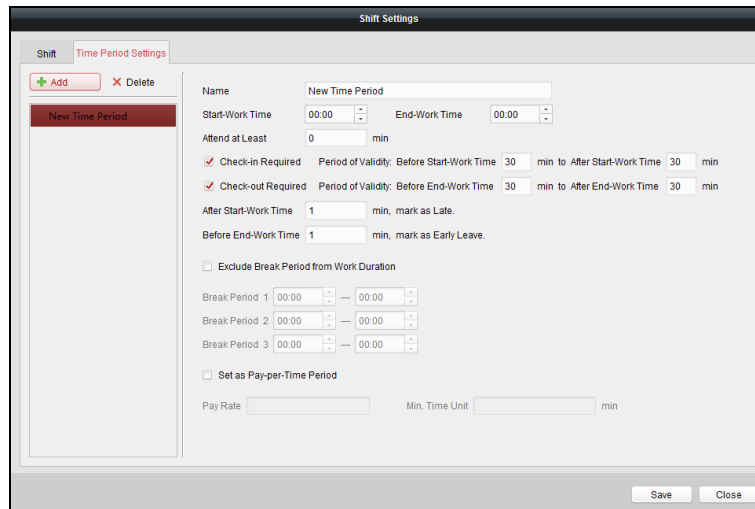

3. Set the related parameters.

Name: Set the name for time period.

Start-Work / End-Work Time: Set the start-work time and end-work time.

Attend at Least: Set the minimum attendance time.

Check-in / Check-out Required: Check the checkboxes and set the valid period for check-in or check-out.

Mark as Late/Mark as Early Leave: Set the time period for late or early leave.

Exclude Break Period from Work Duration: Check the checkbox and set the break period excluded.

Note: Up to 3 break periods can be set.

Set as Pay-per-Time Period: Check the checkbox and set the pay rate and minimum time unit.

4. Click **Save** to save the settings.

The added time period will display on the left panel of the dialog.

You can also click **Delete** to delete the time period.

➤ Adding Shift

Steps:

1. Click **Shift** Tab.
2. Click **Add**.

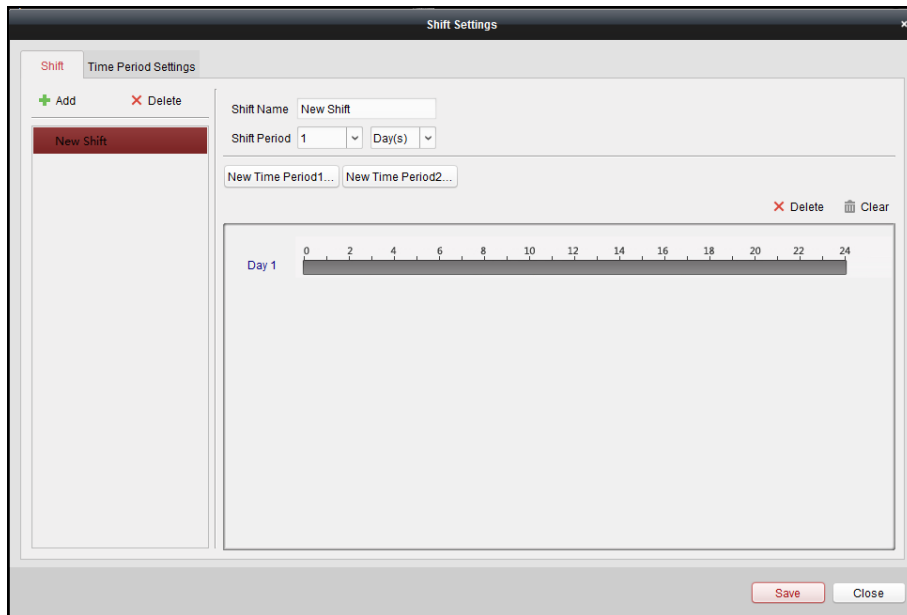

3. Set the name for shift.
4. Select the shift period from the drop-down list.
5. Configure the shift period with the added time period.
 - 1) Select the time period.
 - 2) Click the time bar to apply the time period for the select day.
You can click the time period on the bar and click  or **Delete** to delete the period.
You can also click **Clear** to delete all days' time period.
6. Click **Save** to save the settings.
The added shift will display on the left panel of the dialog.
You can also click **Delete** on the left panel to delete the shift.

Shift Schedule Settings

Purpose:

After setting the shift, you can set department schedule, person schedule and temporary schedule.

Note: The temporary schedule has higher priority than department schedule and person schedule.

➤ **Department Schedule**

You can set the shift schedule for one department, and all the persons in the department will be assigned with the shift schedule.

Note: In Time and Attendance module, the department list is the same with the **organization** in Access Control. For setting the organization in Access Control, refer to *Chapter 6.4 Organization Management*.

Steps:

1. Open the Shift Schedule Management interface and select the department on the left panel.
2. Click **Department Schedule** to pop up Department Schedule dialog.

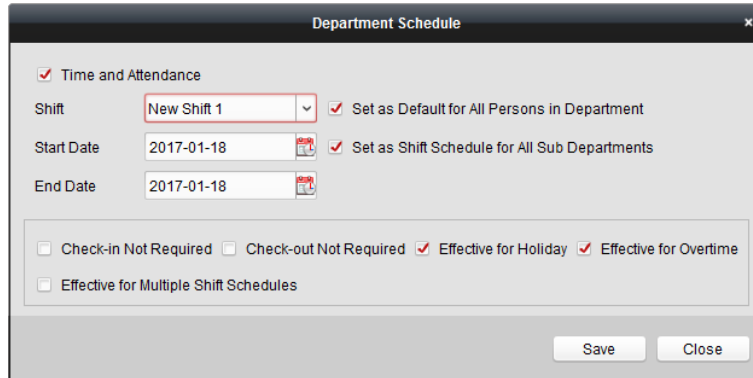

3. Check **Time and Attendance** checkbox.
All persons in the department except those excluded from attendance will apply the attendance schedule.
4. Select the shift from the drop-down list.
5. Set the start date and end date.
6. (Optional) Set other parameters for the schedule.
You can select Check-in Not Required, Check-out Not Required, Effective for Holiday, Effective for Overtime, Effective for Multiple Shift Schedules.

Notes:

- Multiple Shift Schedules contains more than one time periods. The person can check in/out in any of the time periods and the attendance will be effective.
Example: If the multiple shift schedules contains three time periods: 00:00 to 07:00, 08:00 to 15:00 and 16:00 to 23:00. The attendance of the person adopting this multiple shift schedules will be effective in any of the three time periods. If the person checks in at 07:50, it will apply the nearest time period 08:00 to 15:00 to the person's attendance.
- After checking the **Effective for Multiple Shift Schedules** checkbox, you can select the effective time period(s) from the added time periods for the persons in the department.

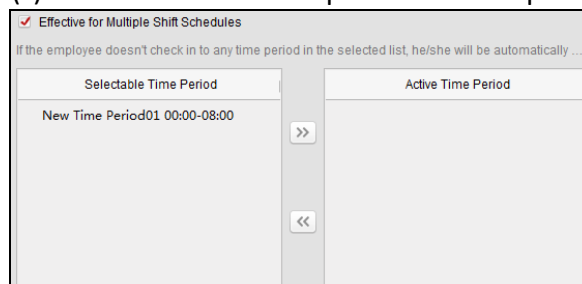

- 1) In the Selectable Time Period list on the left, click the added time period and click >> to add it to the right.
 - 2) (Optional) To remove the selected time period, select it and click <<.
7. (Optional) Check **Set as Default for All Persons in Department** checkbox.
All persons in the department will use this shift schedule by default.
 8. (Optional) If the selected department contains sub department(s), the Set as **Shift Schedule for All Sub Departments** checkbox will display. You can check it to apply the department schedule to its sub departments.
 9. Click **Save** to save the settings.

➤ **Person Schedule**

Steps:

1. Open the Shift Schedule Management interface and select the department on the left panel.
2. Select the person(s) on the right panel.
3. Click **Person Schedule** to pop up Person Schedule dialog.

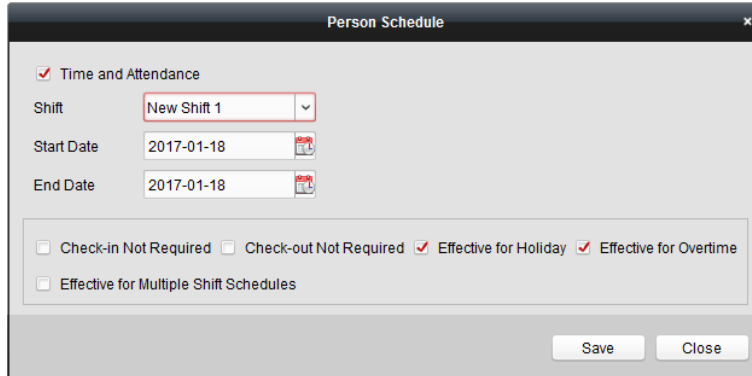

4. Check **Time and Attendance** checkbox.
The configured person will apply the attendance schedule.
5. Select the shift from the drop-down list.
6. Set the start date and end date.
7. (Optional) Set other parameters for the schedule.
You can select Check-in Not Required, Check-out Not Required, Effective for Holiday, Effective for Overtime, Effective for Multiple Shift Schedules.
8. Click **Save** to save the settings.

➤ **Temporary Schedule**

Steps:

1. Open the Shift Schedule Management interface and select the department on the left panel.
2. Select the person(s) on the right panel.
3. Click **Temporary Schedule** to pop up Temporary Schedule dialog.

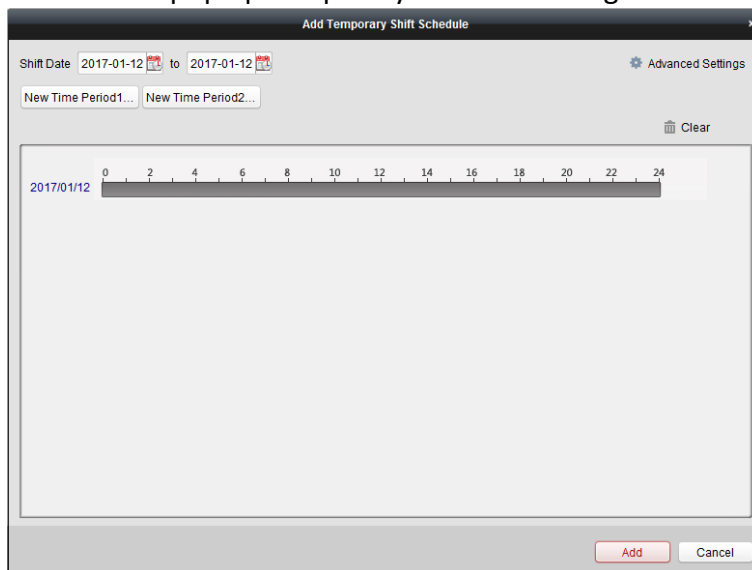

4. Click  to set the shift date.

5. Configure the shift date with the added time period.
 - 1) Select the time period.
 - 2) Click the time bar to apply the time period for the select date.
 You can click the time period on the bar and click  to delete the period.
 You can also click **Clear** to delete all days' time period.
6. You can click **Advanced Settings** to advanced attendance rules for the temporary schedule.

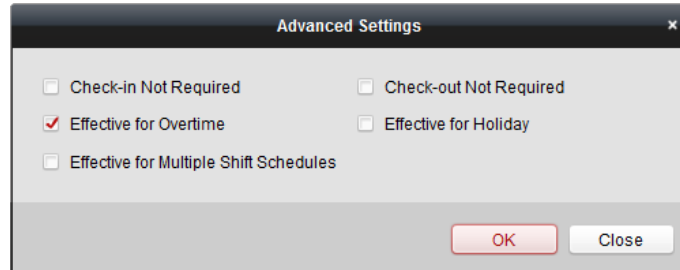

7. Click **Add** to save the settings.

➤ **Checking Shift Schedule Details**

Steps:

1. On the Shift Schedule Management interface, select the department on the left panel.
 2. Select the person(s) on the right panel.
 3. Click **View** to pop up Shift Schedule Details dialog.
- You can check the shift schedule details.

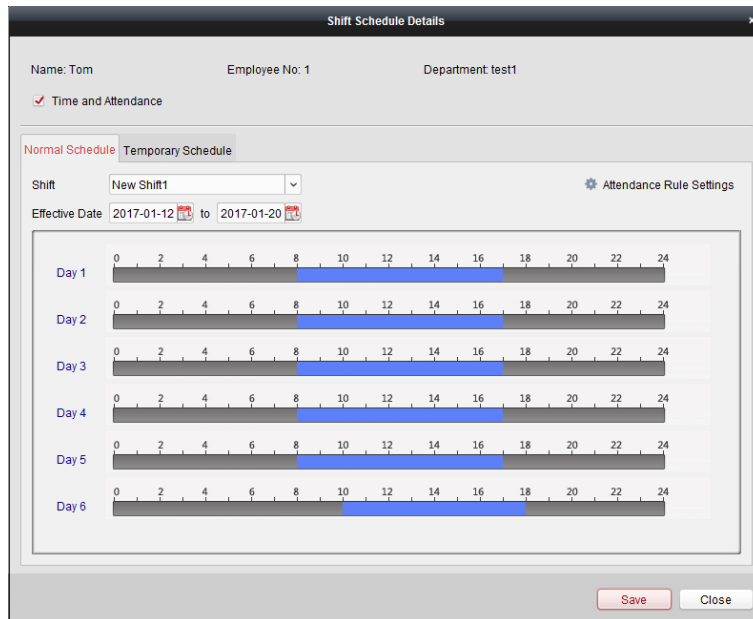

4. Click **Normal Schedule** tab.

You can check and edit the normal schedule details.

 - 1) Select the shift from the drop-down list.
 - 2) Click **Attendance Rule Settings** to pop up Attendance Rule Settings dialog.

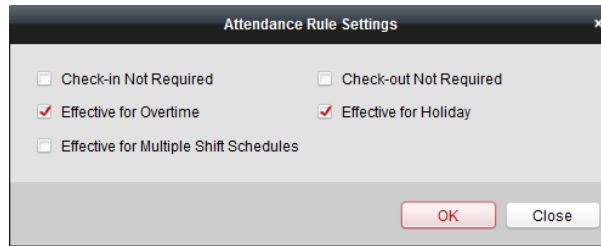

You can check the attendance rules as desired and click **OK** to save the settings.

- 3) Click  to set the effective date.
- 4) Click **Save** to save the settings.
5. (Optional) Click **Temporary Schedule** tab.

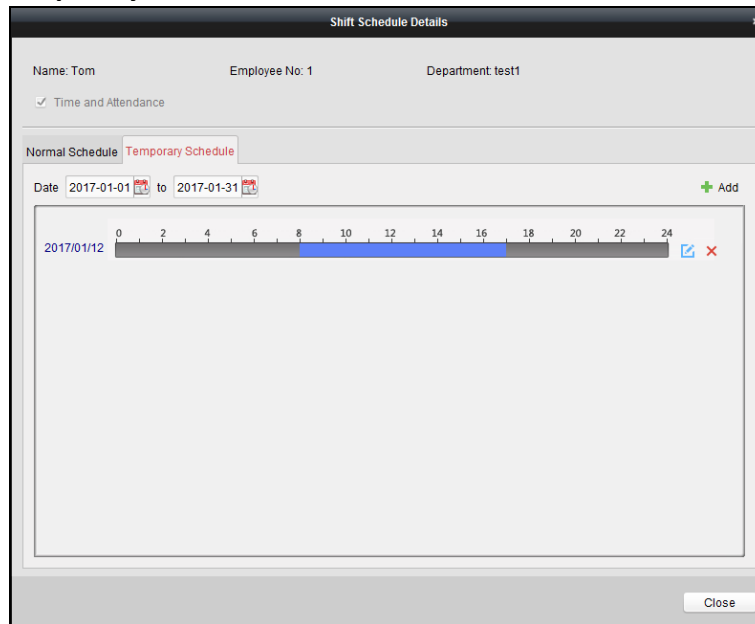

You can check and edit the temporary schedule details.

(Optional) Click **Add** to add temporary schedule for the selected person.

(Optional) Click  to edit the time period.

(Optional) Click  to delete the temporary schedule.

➤ Exporting Shift Schedule Details

On the Shift Schedule Management interface, select the department on the left panel and click **Export** to export all persons' shift schedule details to local PC.

Note: The exported details are saved in *.csv format.

6.14.2 Attendance Handling

Purpose:

You can handle the attendance, including check-in correction, check-out correction, leave and business trip, and manual calculation of attendance.

Open Time and Attendance module and click **Attendance Handling** to enter the Attendance Handling interface.

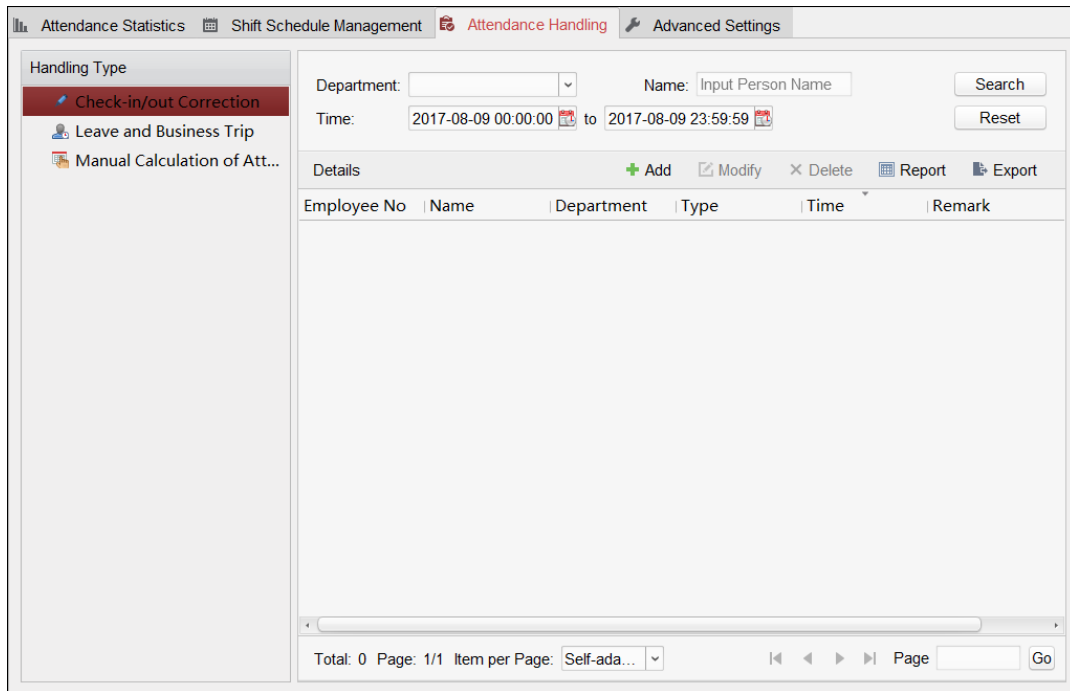

Check-in/out Correction

Purpose:

You can add, edit, delete, search the check-in/out correction and generate the related report. You can also export the check-in/out correction details to local PC.

➤ Add Check-in/out Correction

Steps:

1. Click **Check-in/out Correction** tab.
2. Click **Add** to pop up Add Check-in/out Correction dialog.

3. Set the check-in/out correction parameters.
For Check-in Correction: Check **Check-in** checkbox and set the actual start-work time.
For Check-out Correction: Check **Check-out** checkbox and set the actual end-work time.
4. Click **Employee Name** field and select the person.
 You can also input the keyword and click  to search the person you want.
5. (Optional) Input the remark information as desired.
6. Click **Add** to add the check-in/out correction.

The added check-in/out correction will display on the Attendance Handling interface.
 (Optional) Select the check-in/out correction and click **Modify** to edit the correction.
 (Optional) Select the check-in/out correction and click **Delete** to delete the correction.
 (Optional) Click **Report** to generate the check-in/out correction report.
 (Optional) Click **Export** to export the check-in/out correction details to local PC.

Note: The exported details are saved in *.csv format.

➤ **Search Check-in/out Correction**

Steps:

1. Click **Check-in/out Correction** tab.
2. Set the searching conditions.
Department: Select the department from the drop-down list.
Name: Input the person name.
Time: Click  to set the specified time as time range.
3. Click **Search** to search the check-in/out corrections.
 The check-in/out correction details will display on the list.
 You can also click **Reset** to reset the searching conditions.

Leave and Business Trip



Purpose:

You can add, edit, delete, search the leave and business trip and generate the related report. You can also export the leave and business trip details to local PC.

➤ **Add Leave and Business Trip**

Steps:

1. Click **Leave and Business Trip** tab.
2. Click **Add** to pop up Add Leave and Business Trip Application dialog.

3. Select the leave and business trip type from the Type drop-down list.
You can configure the leave type in Advanced Settings. For details, refer to *Leave Type Settings*.
4. Click  to set the specified time as time range.
5. Click **Employee Name** field and select the person for this application.
You can also input the keyword and click  to search the person you want.
6. (Optional) Input the remark information as desired.
7. Click **Add** to add the leave and business trip.
The added leave and business trip will display on the Attendance Handling interface.
(Optional) Select the leave and business trip and click **Modify** to edit the leave or business trip.
(Optional) Select the leave and business trip and click **Delete** to delete the leave or business trip.
(Optional) Click **Report** to generate the leave or business trip report.
(Optional) Click **Export** to export the leave or business trip details to local PC.
Note: The exported details are saved in *.csv format.

➤ **Search Leave and Business Trip**

Steps:

1. Click **Leave and Business Trip** tab.
2. Set the searching conditions.
Department: Select the department from the drop-down list.
Name: Input the person name.
Time: Click  to set the specified time as time range.
3. Click **Search** to search the leave and business trips.
The leave and business trip details will display on the list.
You can also click **Reset** to reset the searching conditions.

Department:	Department 1	Name:	Input Person Name	<input type="button" value="Search"/>			
Time:	2017-01-18 00:00:00	to	2017-01-18 23:59:59	<input type="button" value="Reset"/>			
Details <input type="button" value="+ Add"/> <input type="button" value="Modify"/> <input type="button" value="X Delete"/> <input type="button" value="Report"/> <input type="button" value="Export"/> 							
Employee No	Name	Department	Type	Reason	Start Time	End Time	Ren
1	Wendy	Department 1	Leave	Paternity Leave	2017-01-18 00:00:00	2017-01-18 23:59:59	
1	Wendy	Department 1	Day Off in Lieu	Overtime Exchange Holiday	2017-01-17 00:00:00	2017-01-17 23:59:59	

Manual Calculation of Attendance

Purpose:

You can calculate the attendance result manually if needed by specifying the start time and end time.

Steps:

1. Click **Manual Calculation of Attendance** tab.
2. Set the start time and end time for calculation.
3. Click **Calculate** to start.

Note: It can only calculate the attendance data within three months.

6.14.3 Advanced Settings

Purpose:

You can configure the basic settings, attendance rule, attendance check point, holiday settings and leave type for attendance.

Open Time and Attendance module and click **Advanced Settings** to enter the Advanced Settings interface.

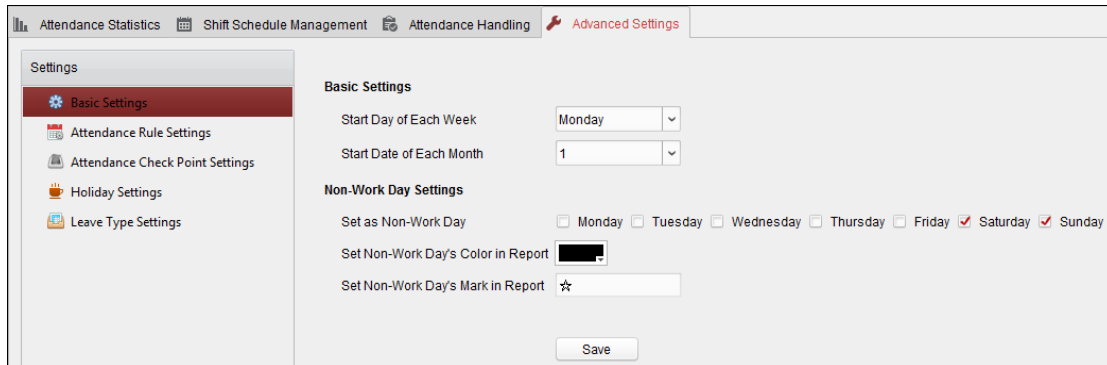

Basic Settings

Steps:

1. Click **Basic Settings** tab to enter the Basic Settings interface.

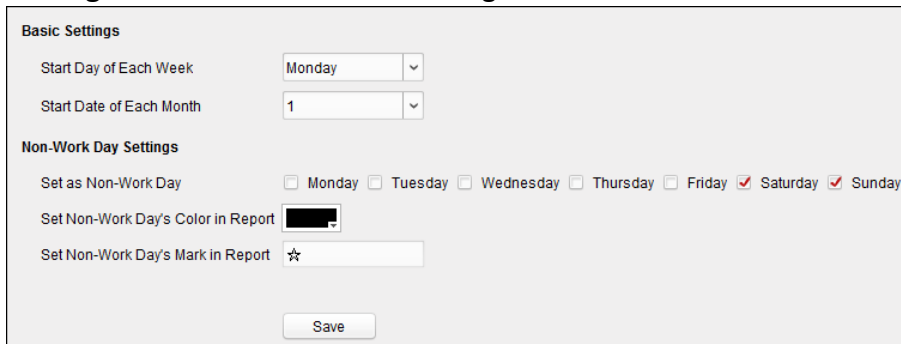

2. Set the basic settings.
 - Start Day of Each Week:** You can select one day as the start day of each week.
 - Start Date of Each Month:** You can select one day as the start date of each month.
3. Set the non-work day settings.
 - Set as Non-Work Day:** Check the checkbox(es) to set the selected day(s) as non-work day.
 - Set Non-Work Day's Color in Report:** Click the color filed and select the color to mark the non-work day in report.
 - Set Non-Work Day's Mark in Report:** Input the mark as non-work day in report.
4. Click **Save** to save the settings.

Attendance Rule Settings

Steps:

1. Click **Attendance Rule Settings** tab to enter the Attendance Rule Settings interface.

2. Set the attendance or absence settings.
 If employee does not check in when starting work, you can mark as **Absent** or **Late** and set the late time.
 If employee does not check out when ending work, you can mark as **Absent** or **Early Leave** and set the early leave duration.
3. Set the Check-in/out Settings.
 You can check the checkbox of **Check-in Required** or **Check-out Required** and set the valid period.
 You can also set the late rule or early leave rule.
Note: The parameters here will be set as default for the newly added time period. It will not affect the existed one(s).
4. Set the overtime settings.
 You can set the overtime rule and set the maximum overtime for each day.
 (Optional) You can check **Non-scheduled Work Day** checkbox and set the overtime rule for non-work day.
5. Click **Save** to save the settings.

Attendance Check Point Settings

You can set the card reader(s) of the access control point as the attendance check point, so that the card swiping on the card reader(s) will be valid for attendance.

Steps:

1. Click **Attendance Check Point Settings** tab to enter the Attendance Check Point Settings interface.

2. Click  to pop up Add Attendance Check Point dialog.

3. Set the related information.

Check Point Name: Input a name for check point.

Card Reader: Select the card reader from the drop-down list.

Check Point Function: Select the function for check point.

Door Location: Input the door location.

Check Point Description: Set the description information for check point.

4. Click **Add** to add the attendance check point.

The added attendance check point will display on the list.

5. (Optional) Check **Set All Card Readers as Check Points** checkbox.

You can use all the card readers as check points.

Note: If this checkbox is unchecked, only the card readers in the list will be added as attendance check points.

You can also edit or delete the card readers.

Click  to edit the card reader.

Click  to delete the card reader.

Holiday Settings

Steps:

1. Click **Holiday Settings** tab to enter the Holiday Settings interface.

Holiday Name	Start Date	End Date	Holiday Days
Christmas	2016-12-22	2016-12-30	9

2. Click  to pop up Add Holiday dialog.

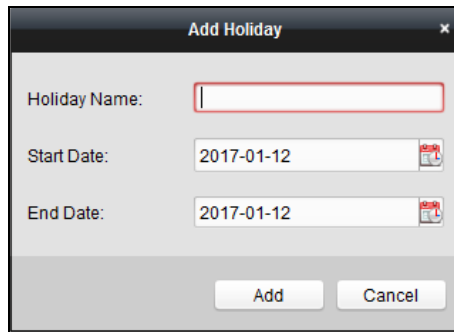

3. Set the related parameters.

Holiday Name: Input the name for the holiday.

Start Date / End Date: Click  to specify the holiday date.

4. Click **Add** to add the holiday.

The added holiday will display on the list.

You can also edit or delete the holiday.

Click  to edit the holiday.

Click  to delete the holiday.

Leave Type Settings

Purpose

Steps:

1. Click **Leave Type Settings** tab to enter the Leave Type Settings interface.

Leave	Minor Type
	Index Type
Day Off in Lieu	1 Paternity Leave
Go Out on Business	2 Parental Leave
	3 Sick Leave
	4 Family Reunion Leave
	5 Annual Leave
	6 Maternity Leave
	7 Personal Leave
	8 Bereavement Leave

2. Add the major leave type.

1) Click  on the left panel to pop up the Add Major Leave Type dialog.

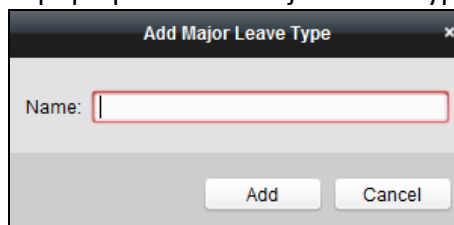

2) Input the name for major leave type.

3) Click **Add** to add the major leave type.

You can also edit or delete the major leave type.

Click  to edit the major leave type.

Click **X** to delete the major leave type.

3. Add the minor leave type.

1) Select the major leave type.

The minor leave type belonging to this major leave type will display on the right panel.

2) Click **+** on the right panel to pop up the Add Minor Leave Type dialog.

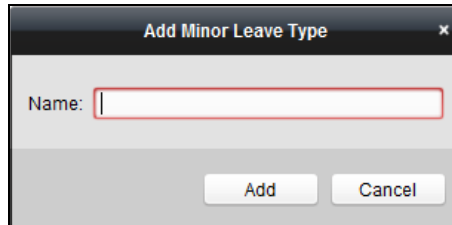

3) Input the name for minor leave type.

4) Click **Add** to add the minor leave type.

You can also edit or delete the major leave type.

Click **✎** to edit the minor leave type.

Click **X** to delete the minor leave type.

6.14.4 Attendance Statistics

Purpose:

After calculating attendance data, you can check the attendance summary, attendance details, abnormal attendance, overtime, card swiping logs and reports based on the calculated attendance data.

Notes:

- The client automatically calculates the previous day's attendance data at 1:00 am on the next day.
- Keep the client running at 1:00 am or it cannot calculate the previous day's attendance data automatically. If not calculated automatically, you can calculate the attendance data manually. For details, refer to *Manual Calculation of Attendance* in Chapter 6.14.2 Attendance Handling.

Attendance Summary

Purpose:

You can get all the attendance information statistics of the employees in the specified time period.

Steps:

1. In the Time and Attendance module, click **Attendance Statistics** tab to enter the Attendance Statistics page.
2. Click **Attendance Summary** item on the left panel to enter the Attendance Summary interface.

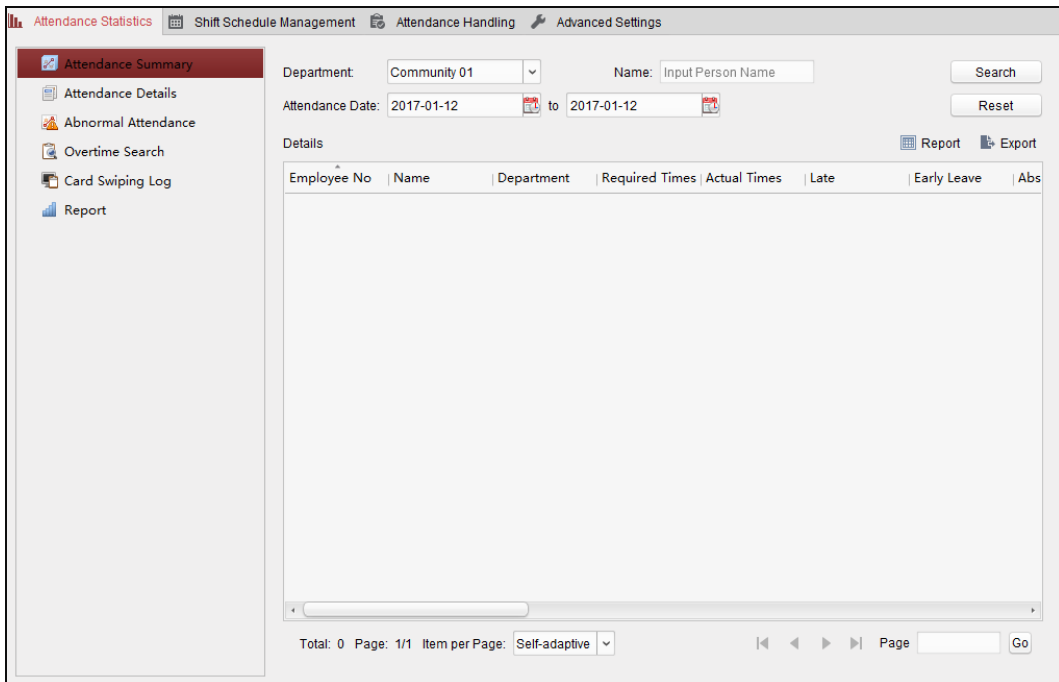

3. Set the search conditions, including department, employee name and attendance date.
(Optional) You can click **Reset** to reset all the configured search conditions.
4. Click **Search** to start searching and the matched results will list on this page.
(Optional) Click **Report** to generate the attendance report.
(Optional) Click **Export** to export the results to the local PC.

Attendance Details

Steps:

1. In the Attendance Statistics page, click **Attendance Details** item on the left panel to enter the Attendance Details interface.

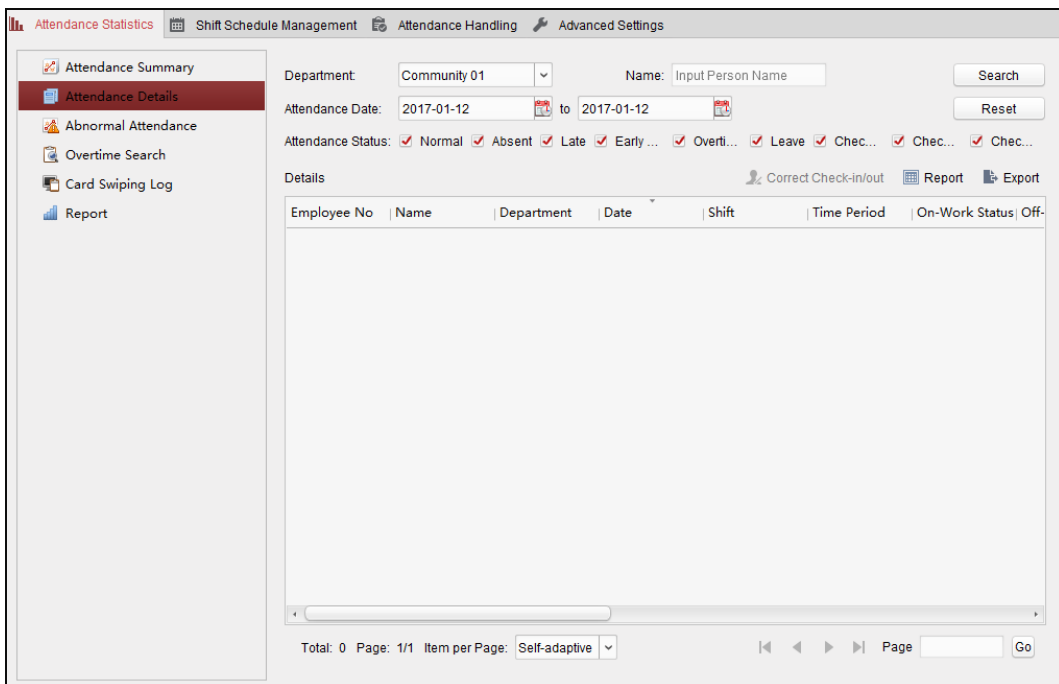

2. Set the search conditions, including department, employee name, attendance date and status.
(Optional) You can click **Reset** to reset all the configured search conditions.
3. Click **Search** to start searching and the matched results will list on this page.
(Optional) You can select a result item in the list and click **Correct Check-in/out** to correct the check-in or check-out status.
(Optional) Click **Report** to generate the attendance report.
(Optional) Click **Export** to export the results to the local PC.

Abnormal Attendance

You can search and get the statistics of the abnormal attendance data, including No., name and department of the employees, abnormal type, start/end time and date of attendance. For detailed operations, refer to *Chapter 6.14.4 Attendance Statistics*.

Overtime Search

You can search and get the overtime status statistics of the selected employee in the specified time period. And you can check the detailed overtime information, including No., name and department of the employees, attendance date, overtime duration and overtime type. For detailed operations, refer to *Chapter 6.14.4 Attendance Statistics*.

Card Swiping Log

You can search the card swiping logs used for the attendance statistics. After searching the logs, you can check the card swiping details, including name and department of the employees, card swiping time, card reader authentication mode and card No.. For detailed operations, refer to *Chapter 6.14.4 Attendance Statistics*.

Report

In the Attendance Statistics page, click **Report** item on the left panel to enter the Report interface.

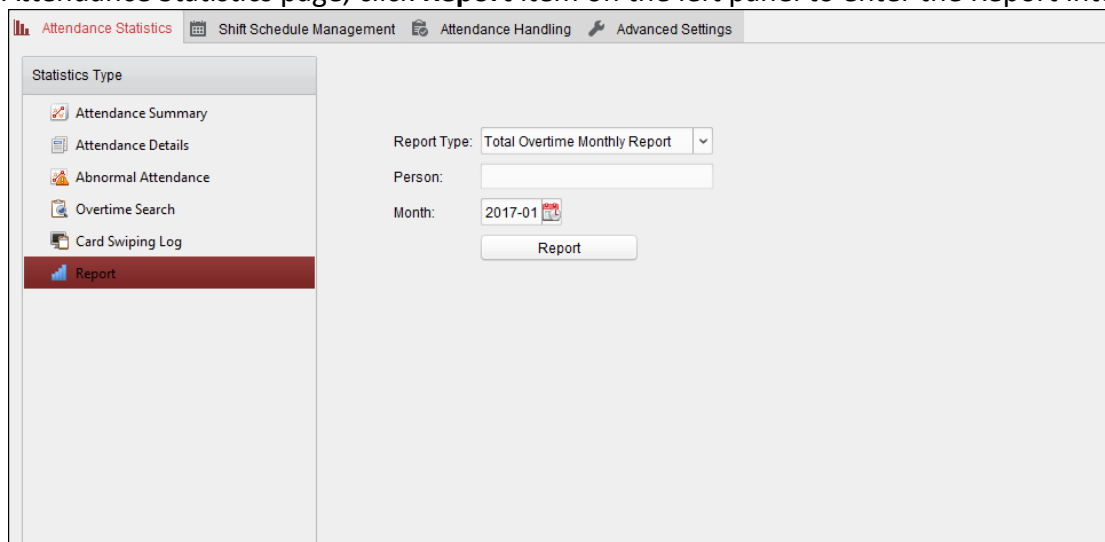

➤ Generating Total Overtime Monthly Report

Steps:

1. Click  in the Report Type field to unfold the drop-down list and select **Total Overtime**

Monthly Report as the report type.

2. Click **Person** field to select the person.
3. Click  to specify a month.
4. Click **Report** to start generating the matched total overtime monthly report.

➤ **Generating Overtime Details Monthly Report**

Select **Overtime Details Monthly Report** as the report type. You can generate overtime details monthly report. For detailed operations, refer to *Generating Total Overtime Monthly Report*.

➤ **Generating Attendance Monthly Report**

Select **Attendance Monthly Report** as the report type. You can generate attendance monthly report. For detailed operations, refer to *Generating Total Overtime Monthly Report*.

➤ **Generating Start/End-Work Time Report**

Steps:

1. Click  in the report type field to unfold the drop-down list and select **Start/End-Work Time Report** as the report type.

2. Click **Department** field to select the department.
3. Click  to specify the start date and end date of a date period.
4. Click **Report** to start generating the matched total overtime monthly report.

➤ **Generating Department Attendance Report**

Set the report type as **Department Attendance Report** and you can generate department attendance report. For detailed operations, refer to *Generating Start/End-Work Time Report* above.

Appendix B Tips for Scanning Fingerprint

Recommended Finger

Forefinger, middle finger or the third finger.

Correct Scanning

The figure displayed below is the correct way to scan your finger:

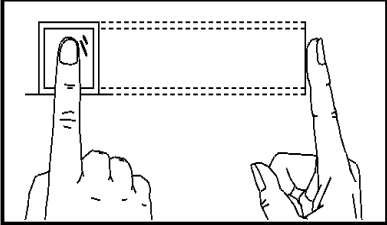

You should press your finger on the scanner horizontally. The center of your scanned finger should align with the scanner center.

Incorrect Scanning

The figures of scanning fingerprint displayed below are wrong:

Vertical

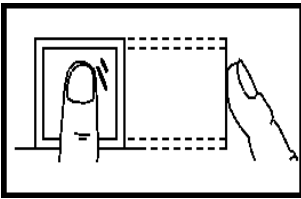

Edge I

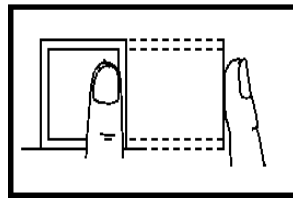

Side

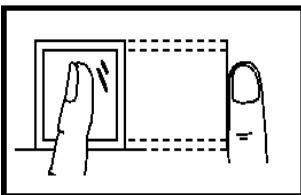

Edge II

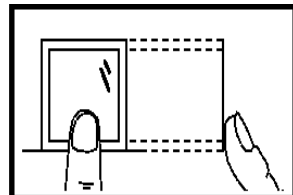

Environment

The scanner should avoid direct high light, high temperature, humid conditions and rain.

When it is dry, the scanner may not recognize your fingerprint successfully. You can blow your finger and scan again after drying the finger.

Others

If your fingerprint is shallow, or it is hard to scan your fingerprint, we recommend you to use other authentication methods.

If you have injuries on the scanned finger, the scanner may not recognize. You can change another finger and try again.

Appendix C Tips When Collecting/Comparing Face Picture

C.1 Positions (Recommended Distance:0.5m)

The position when collecting or comparing face picture is as below:

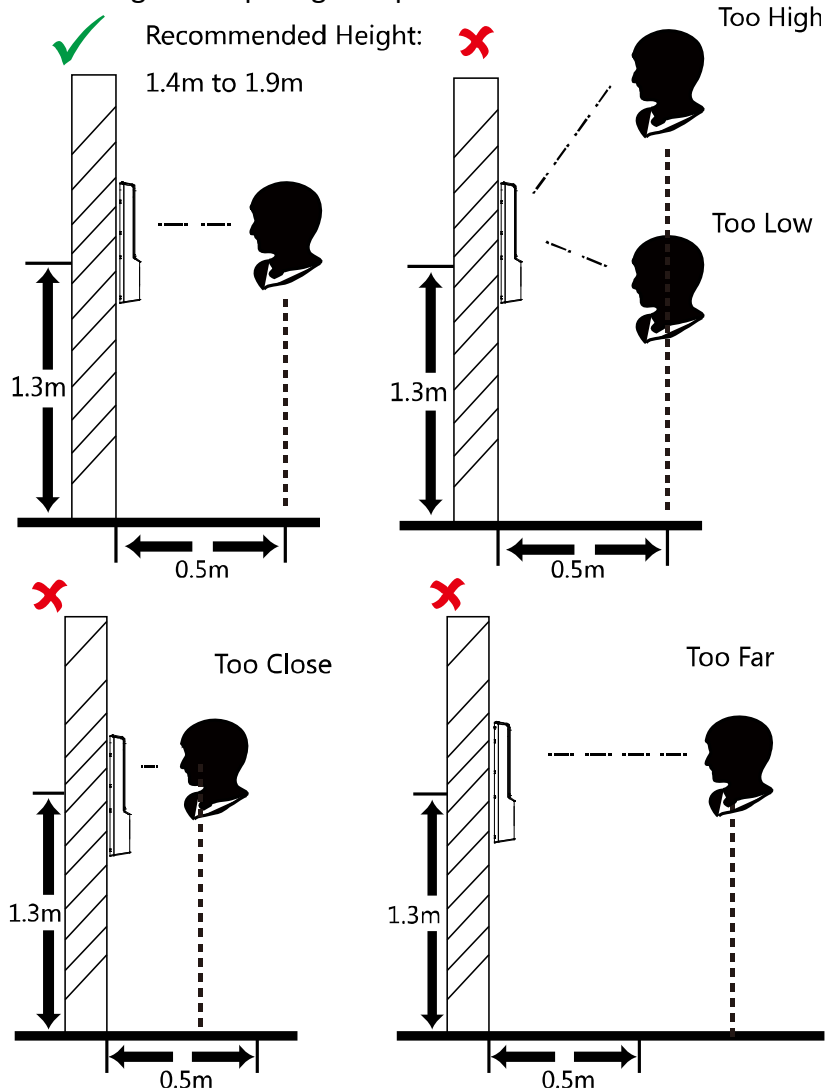

Note: For details about the relationship among person height, device height, and the distance between the person and the device, see Appendix C.

C.2 Expression

- Keep your expression naturally when collecting or comparing face pictures, just like the expression in the picture below.

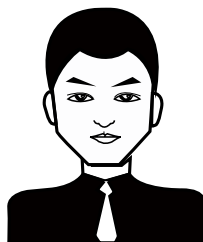

- Do not wear hat, sunglasses, or other accessories that can affect the facial recognition function.
- Do not make your hair cover your eyes, ears, etc. and heavy makeup is not allowed.

C.3 Posture

In order to get a good quality and accurate face picture, position your face looking at the camera when collecting or comparing face pictures.

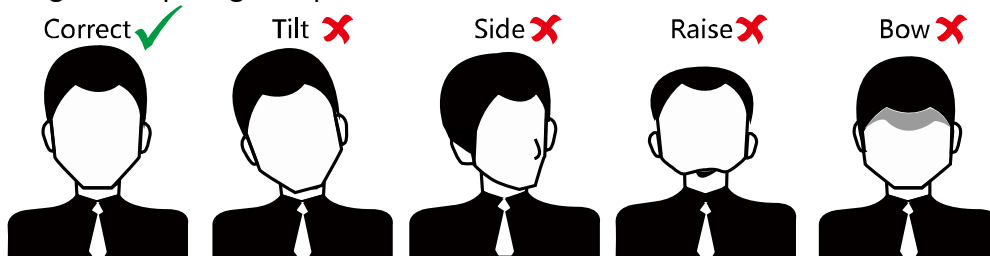

C.4 Size

Make sure your face is in the middle of the collecting window.

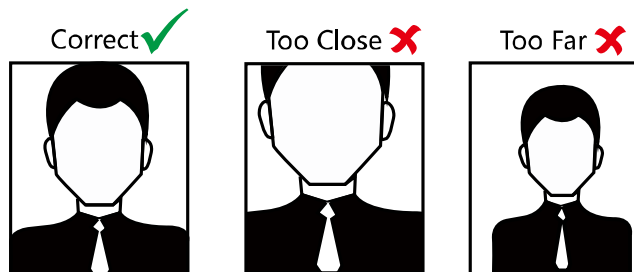

Appendix D Tips for Installation Environment

1. Light Source Illumination Reference Value



Candel: 10Lux



Bulb: 100~850Lux



Sunlight: More than 1200Lux

- If the light source is 0.5 m away from the device, the illumination should be no less than 100 Lux.
- Install the device indoors, at least 2 meters away from the light, and at least 3 meters away from the window or door.

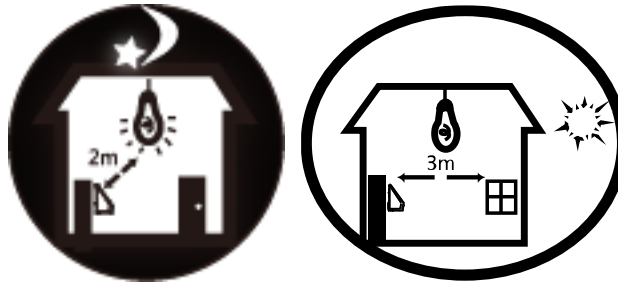

4. Avoid backlight, direct and indirect sunlight.

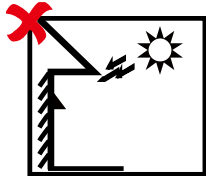

Backlight

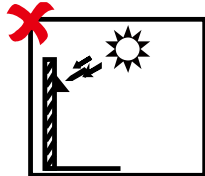

Direct Sunlight

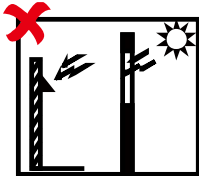

Direct Sunlight
through Window

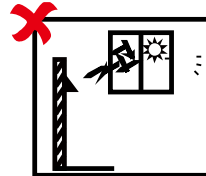

Indirect Sunlight
through Window

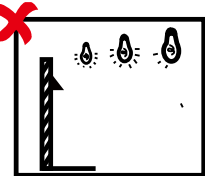

Close to Light

Appendix E Dimension

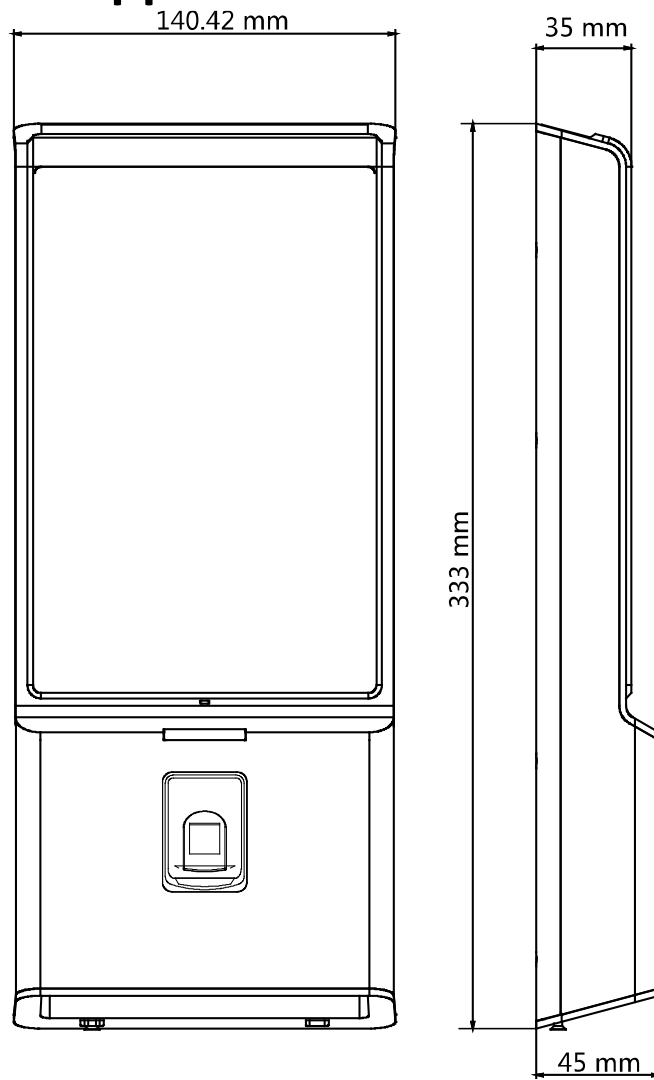

010000001080830

