

## DS-2DE4415IW-DE(T5) 4MP 15× IR Network Speed Dome

### AcuSense



Hikvision DS-2DE4415IW-DE(T5) 4MP 15× Network IR Speed Dome adopts 1/2.8" progressive scan CMOS chip. With the 15× optical zoom lens, the camera offers more details over expansive areas.

This series of cameras can be widely used for wide ranges of high-definition, such as the rivers, roads, railways, airports, squares, parks, scenic spots, and venues, etc.

Empowered by deep learning algorithms, Hikvision AcuSense technology brings human and vehicle targets classification alarms to front- and back-end devices. The system focuses on human and vehicle targets, vastly improving alarm efficiency and effectiveness.

- Focuses on human and vehicle targets classification based on deep learning
- Support face capture. Up to 5 faces captured at the same time
- 1/2.8" Progressive Scan CMOS
- High quality imaging with 4 MP resolution
- Excellent low-light performance with powered-by-DarkFighter technology
- 15× optical zoom and 16× digital zoom provide close up views over expansive areas
- Expansive night view with up to 100 m IR distance
- Support H.265+/H.265 video compression



## ▪ DORI

The DORI (detect, observe, recognize, identify) distance gives the general idea of the camera ability to distinguish persons or objects within its field of view. It is calculated based on the camera sensor specification and the criteria given by EN 62676-4: 2015.

| DORI           | Detect               | Observe             | Recognize          | Identify           |
|----------------|----------------------|---------------------|--------------------|--------------------|
| Definition     | 25 px/m              | 63 px/m             | 125 px/m           | 250 px/m           |
| Distance(Tele) | 1320.0 m (4330.7 ft) | 523.8 m (1718.5 ft) | 264.0 m (866.1 ft) | 132.0 m (433.1 ft) |

## ▪ Specification

| Camera                 |   |
|------------------------|---|
| Image Sensor           | 1/2.8" progressive scan CMOS  |
| Min. Illumination      | Color: 0.005Lux @ (F1.6, AGC ON); B/W: 0.001Lux @ (F1.6, AGC ON), 0 Lux with IR   |
| Shutter Speed          | 1/1 s to 1/30000 s  |
| Slow Shutter           | Yes   |
| Day & Night            | IR cut filter   |
| Zoom                   | 15x optical, 16x digital  |
| Max. Resolution        | 2560 × 1440   |
| Lens                   |   |
| Focus                  | Auto, semi-auto, manual   |
| Focal Length           | 5 mm to 75 mm   |
| Zoom Speed             | Approx. 2.3 s   |
| FOV                    | Horizontal field of view: 55° to 4° (wide-tele),<br>Vertical field of view: 33° to 2.2° (wide-tele),<br>Diagonal field of view: 61.5° to 4.6° (wide-tele) |
| Aperture               | Max. F1.6   |
| Illuminator            |   |
| Supplement Light Type  | IR  |
| Supplement Light Range | IR Distance: up to 100 m  |
| PTZ                    |   |
| Movement Range (Pan)   | 360°  |
| Movement Range (Tilt)  | -15° to 90° (auto flip)   |
| Pan Speed              | Pan speed: configurable from 0.1° to 80°/s; preset speed: 80°/s   |
| Tilt Speed             | Tilt speed: configurable from 0.1° to 80°/s, preset speed 80°/s   |
| Proportional Pan       | Yes   |
| Presets                | 300   |
| Patrol Scan            | 8 patrols, up to 32 presets for each patrol   |
| Pattern Scan           | 4 pattern scans   |
| Power-off Memory       | Yes   |
| Park Action            | Preset, pattern scan, patrol scan, auto scan, tilt scan, random scan, frame scan, panorama scan   |
| 3D Positioning         | Yes   |
| PTZ Status Display     | Yes   |
| Preset Freezing        | Yes   |

|                             |   |
|-----------------------------|---|
| Scheduled Task              | Preset, pattern scan, patrol scan, auto scan, tilt scan, random scan, frame scan, panorama scan, dome reboot, dome adjust, aux output   |
| <b>Video</b>                |   |
| Main Stream                 | 50 Hz: 25 fps (2560 × 1440, 1920 × 1080, 1280 × 960, 1280 × 720)<br>60 Hz: 30 fps (2560 × 1440, 1920 × 1080, 1280 × 960, 1280 × 720)  |
| Sub-Stream                  | 50 Hz: 25 fps (704 × 576, 640 × 480, 352 × 288)<br>60Hz: 30fps (704 × 480, 640 × 480, 352 × 240)  |
| Third Stream                | 50 Hz: 25 fps (1920 × 1080, 1280 × 960, 1280 × 720, 704 × 576, 640 × 480, 352 × 288)<br>60 Hz: 30 fps (1920 × 1080, 1280 × 960, 1280 × 720, 704 × 480, 640 × 480, 352 × 240)  |
| Video Compression           | Main stream: H.265+/H.265/H.264+/H.264<br>Sub-stream: H.265/H.264/MJPEG<br>Third stream: H.265/H.264/MJPEG  |
| Video Bit Rate              | 32 kbps to 16384 kbps   |
| H.264 Type                  | Baseline profile/Main profile/High profile  |
| H.265 Type                  | Main profile  |
| Scalable Video Coding (SVC) | H.264 and H.265 encoding  |
| Region of Interest (ROI)    | 8 fixed regions for each stream   |
| <b>Audio</b>                |   |
| Audio Compression           | G.711/G.722.1/G.726/MP2L2/PCM   |
| Audio Bit Rate              | 64 Kbps (G.711)/16 Kbps (G.722.1)/16 Kbps (G.726)/32-192 Kbps (MP2L2)   |
| Audio Sampling Rate         | 8 kHz/16 kHz/32 kHz/48 kHz  |
| Environment Noise Filtering | Yes   |
| <b>Network</b>              |   |
| Network Storage             | NAS (NFS, SMB/CIFS), auto network replenishment (ANR)   |
| Protocols                   | IPv4/IPv6, HTTP, HTTPS, 802.1x, QoS, FTP, SMTP, UPnP, SNMP, DNS, DDNS, NTP, RTSP, RTCP, RTP, TCP/IP, UDP, IGMP, ICMP, DHCP, PPPoE, Bonjour  |
| API                         | Open Network Video Interface (Version 19.12, Profile S, Profile G, Profile T), ISAPI, SDK, ISUP   |
| Simultaneous Live View      | Up to 20 channels   |
| User/Host                   | Up to 32 users, 3 user levels: administrator, operator, and user  |
| Smooth Streaming            | Yes   |
| Security                    | Password protection, complicated password, HTTPS encryption, 802.1X authentication (EAP-TLS, EAP-LEAP, EAP-MD5), watermark, IP address filter, basic and digest authentication for HTTP/HTTPS, RTP/RTSP over HTTPS, control timeout settings, security audit log, TLS 1.2, TLS 1.3, host authentication (MAC address) |
| Client                      | iVMS-4200, HikCentral Pro, Hik-Connect  |
| Web Browser                 | Chrome 57.0+, Firefox 52.0+, Safari 11+, IE11   |
| <b>Image</b>                |   |
| Image Parameters Switch     | Yes   |
| Day/Night Switch            | Day, Night, Auto, Schedule  |
| Image Enhancement           | BLC, HLC, 3D DNR  |
| Wide Dynamic Range (WDR)    | 120 dB  |
| Defog                       | Digital defog   |
| Image Stabilization         | EIS   |
| Regional Exposure           | Yes   |

|                               |   |
|-------------------------------|---|
| Regional Focus                | Yes   |
| Image Settings                | Saturation, brightness, contrast, sharpness, gain, and white balance adjustable by client software or web browser   |
| Privacy Mask                  | 24 programmable polygon privacy masks, mask color or mosaic configurable  |
| SNR                           | > 52 dB   |
| <b>Interface</b>              |   |
| Ethernet Interface            | 1 RJ45 10M/100M self-adaptive Ethernet port   |
| On-board Storage              | Built-in memory card slot, support microSD/SDHC/SDXC card, up to 256 GB   |
| Alarm                         | 1 input, 1 output   |
| Audio                         | 1 input (line in), max. input amplitude: 2-2.4 vpp, input impedance: 1 k $\Omega$ $\pm$ 10%;<br>1 output (line out), line level, output impedance: 600 $\Omega$   |
| Reset                         | Yes   |
| <b>Event</b>                  |   |
| Basic Event                   | Motion detection, video tampering alarm, exception, alarm input and output  |
| Smart Event                   | Line crossing detection, intrusion detection, region entrance detection, region exiting detection, unattended baggage detection, object removal detection, audio exception detection  |
| Alarm Linkage                 | Upload to FTP/NAS/memory card, notify surveillance center, send email, trigger alarm output, trigger recording, and PTZ actions (such as preset, patrol scan, pattern scan)   |
| <b>Deep Learning Function</b> |   |
| Face Capture                  | Detects up to 5 faces simultaneously.<br>Supports detecting, capturing, grading, selecting of face in motion, and output the best face picture of the face  |
| Perimeter Protection          | Line crossing, intrusion, region entrance, region exiting<br>Support alarm triggering by specified target types (human and vehicle)   |
| <b>General</b>                |   |
| Demist                        | Yes   |
| Power                         | 12 VDC, max. 18 W, including max. 1.6 W for heater and 9 W for IR;<br>PoE (802.3at)   |
| Operating Condition           | -30 $^{\circ}$ C to 65 $^{\circ}$ C (-22 $^{\circ}$ F to 149 $^{\circ}$ F). Humidity 90% or less (non-condensing)   |
| Material                      | ADC12   |
| Dimension                     | $\varnothing$ 164.5 mm $\times$ 290 mm ( $\varnothing$ 6.48" $\times$ 11.42")   |
| Weight                        | Approx. 2 kg (4.41 lb)  |
| <b>Approval</b>               |   |
| EMC                           | FCC SDoC (47 CFR Part 15, Subpart B);<br>CE-EMC (EN 55032: 2015, EN 61000-3-2: 2019, EN 61000-3-3: 2013, EN 50130-4: 2011 +A1: 2014);<br>RCM (AS/NZS CISPR 32: 2015);<br>IC VoC (ICES-003: Issue 6, 2019);<br>KC (KN 32: 2015, KN 35: 2015) |
| Safety                        | UL (UL 62368-1);<br>CB (IEC 60950-1:2005 + Am 1:2009 + Am 2:2013, IEC 62368-1:2014);<br>CE-LVD (EN 62368-1:2014+A11:2017);<br>BIS (IS 13252(Part 1):2010+A1:2013+A2:2015);<br>LOA (SANS IEC60950-1)   |

|             |  |
|-------------|--|
| Environment | CE-RoHS (2011/65/EU); WEEE (2012/19/EU);<br>Reach (Regulation (EC) No 1907/2006)                         |
| Protection  | IP66 (IEC 60529-2013), TVS 6000V lightning protection, surge protection and voltage transient protection |

▪ **Available Model**

DS-2DE4415IW-DE(T5)

▪ **Dimension**

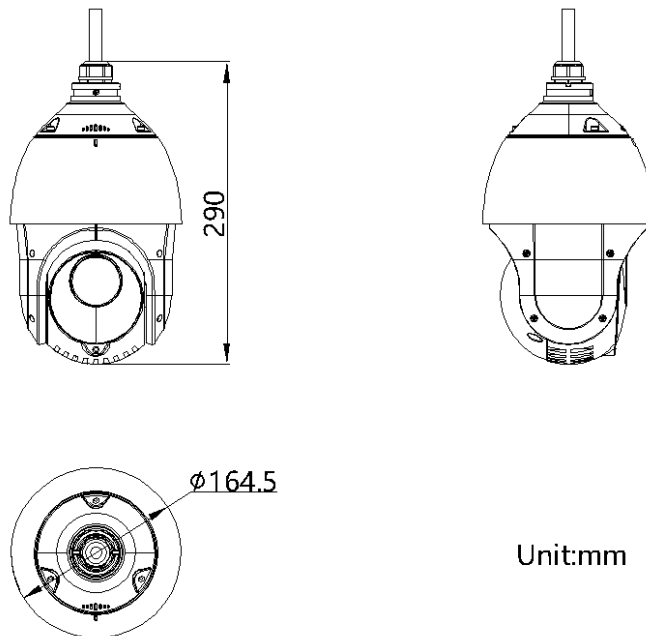



















▪ **Accessory**

▪ **Included**



▪ Optional

|   |   |   |   |   |
|---|---|---|---|---|
| <b>DS-1602ZJ</b>  | <b>DS-1673ZJ</b>  | <b>DS-1671ZJ-SDM9</b>   | <b>DS-1604ZJ-corner</b>   | <b>DS-1604ZJ</b>  |
|    |    |    |    |    |
| <b>DS-1604ZJ-pole</b>   | <b>DS-1682ZJ</b>  | <b>DS-1604ZJ-BOX-CORNER</b>   |   | <b>DS-1661ZJ</b>  |
|    |    |    |    |    |
| <b>DS-1667ZJ</b>  | <b>DS-1005KI</b>  | <b>DS-1619ZJ</b>  | <b>DS-1660ZJ</b>  | <b>DS-1662ZJ</b>  |
|  |  |  |  |  |
| <b>DS-1663ZJ</b>  | <b>DS-1604ZJ-BOX-POLE</b>   | <b>DS-1604ZJ-box</b>  | <b>DS-1100KI</b>  |   |
|  |  |  |  |   |

Distributed by

**HIKVISION®****Headquarters**

No.555 Qianmo Road, Binjiang District,  
Hangzhou 310051, China  
T +86-571-8807-5998  
overseasbusiness@hikvision.com

**Hikvision USA**  
T +1-909-895-0400  
sales.usa@hikvision.com

**Hikvision Australia**  
T +61-2-8599-4233  
salesau@hikvision.com

**Hikvision India**  
T +91-22-28469900  
sales@pramahikvision.com

**Hikvision Canada**  
T +1-866-200-6690  
sales.canada@hikvision.com

**Hikvision Thailand**  
T +662-275-9949  
sales.thailand@hikvision.com

**Hikvision Europe**  
T +31-23-5542770  
sales.eu@hikvision.com

**Hikvision Italy**  
T +39-0438-6902  
info.it@hikvision.com

**Hikvision Brazil**  
T +55 11 3318-0050  
Latam.support@hikvision.com

**Hikvision Turkey**  
T +90 (216)521 7070- 7074  
sales.tr@hikvision.com

**Hikvision Malaysia**  
T +601-7652-2413  
sales.my@hikvision.com

**Hikvision UK & Ireland**  
T +01628-902140  
sales.uk@hikvision.com

**Hikvision South Africa**  
Tel: +27 (10) 0351172  
sale.africa@hikvision.com

**Hikvision France**  
T +33(0)1-85-330-450  
info.fr@hikvision.com

**Hikvision Kazakhstan**  
T +7-727-9730667  
nikia.panfilov@hikvision.ru

**Hikvision Vietnam**  
T +84-974270888  
sales.vt@hikvision.com

**Hikvision UAE**  
T +971-4-4432090  
salesme@hikvision.com

**Hikvision Singapore**  
T +65-6684-4718  
sg@hikvision.com

**Hikvision Spain**  
T +34-91-737-16-55  
info.es@hikvision.com

**Hikvision Tashkent**  
T +99-87-1238-9438  
uzb@hikvision.ru

**Hikvision Hong Kong**  
T +852-2151-1761  
info.hk@hikvision.com

**Hikvision Russia**  
T +7-495-669-67-99  
saleru@hikvision.com

**Hikvision Korea**  
T +82-(0)31-731-8817  
sales.korea@hikvision.com

**Hikvision Poland**  
T +48-22-460-01-50  
info.pl@hikvision.com

**Hikvision Indonesia**  
T +62-21-2933759  
Sales.Indonesia@hikvision.com

**Hikvision Colombia**  
sales.colombia@hikvision.com