



**Thermal & Optical Bi-spectrum
Network Bullet Camera**

Quick Start Guide

© 2019 Hangzhou Hikvision Digital Technology Co., Ltd. All rights reserved.

This Manual is the property of Hangzhou Hikvision Digital Technology Co., Ltd. or its affiliates (hereinafter referred to as “Hikvision”), and it cannot be reproduced, changed, translated, or distributed, partially or wholly, by any means, without the prior written permission of Hikvision. Unless otherwise expressly stated herein, Hikvision does not make any warranties, guarantees or representations, express or implied, regarding to the Manual, any information contained herein.

About this Manual

The Manual includes instructions for using and managing the Product. Pictures, charts, images and all other information hereinafter are for description and explanation only. The information contained in the Manual is subject to change, without notice, due to firmware updates or other reasons. Please find the latest version of this Manual at the Hikvision website (<http://www.hikvision.com/en/>).

Please use this Manual with the guidance and assistance of professionals trained in supporting the Product.

Trademarks Acknowledgement

HIKVISION and other Hikvision’s trademarks and logos are the properties of Hikvision in various jurisdictions.

Other trademarks and logos mentioned are the properties of their respective owners.

LEGAL DISCLAIMER

TO THE MAXIMUM EXTENT PERMITTED BY APPLICABLE LAW, THIS

MANUAL AND THE PRODUCT DESCRIBED, WITH ITS HARDWARE, SOFTWARE AND FIRMWARE, ARE PROVIDED "AS IS" AND "WITH ALL FAULTS AND ERRORS". HIKVISION MAKES NO WARRANTIES, EXPRESS OR IMPLIED, INCLUDING WITHOUT LIMITATION, MERCHANTABILITY, SATISFACTORY QUALITY, OR FITNESS FOR A PARTICULAR PURPOSE. THE USE OF THE PRODUCT BY YOU IS AT YOUR OWN RISK. IN NO EVENT WILL HIKVISION BE LIABLE TO YOU FOR ANY SPECIAL, CONSEQUENTIAL, INCIDENTAL, OR INDIRECT DAMAGES, INCLUDING, AMONG OTHERS, DAMAGES FOR LOSS OF BUSINESS PROFITS, BUSINESS INTERRUPTION, OR LOSS OF DATA, CORRUPTION OF SYSTEMS, OR LOSS OF DOCUMENTATION, WHETHER BASED ON BREACH OF CONTRACT, TORT (INCLUDING NEGLIGENCE), PRODUCT LIABILITY, OR OTHERWISE, IN CONNECTION WITH THE USE OF THE PRODUCT, EVEN IF HIKVISION HAS BEEN ADVISED OF THE POSSIBILITY OF SUCH DAMAGES OR LOSS.

YOU ACKNOWLEDGE THAT THE NATURE OF INTERNET PROVIDES FOR INHERENT SECURITY RISKS, AND HIKVISION SHALL NOT TAKE ANY RESPONSIBILITIES FOR ABNORMAL OPERATION, PRIVACY LEAKAGE OR OTHER DAMAGES RESULTING FROM CYBER-ATTACK, HACKER ATTACK, VIRUS INSPECTION, OR OTHER INTERNET SECURITY RISKS; HOWEVER, HIKVISION WILL PROVIDE TIMELY TECHNICAL SUPPORT IF REQUIRED.

YOU AGREE TO USE THIS PRODUCT IN COMPLIANCE WITH ALL APPLICABLE LAWS, AND YOU ARE SOLELY RESPONSIBLE FOR ENSURING THAT YOUR USE CONFORMS TO THE APPLICABLE LAW. ESPECIALLY, YOU ARE RESPONSIBLE, FOR USING THIS PRODUCT IN A MANNER THAT DOES NOT INFRINGE ON THE RIGHTS OF THIRD PARTIES, INCLUDING WITHOUT LIMITATION, RIGHTS OF PUBLICITY,

INTELLECTUAL PROPERTY RIGHTS, OR DATA PROTECTION AND OTHER PRIVACY RIGHTS. YOU SHALL NOT USE THIS PRODUCT FOR ANY PROHIBITED END-USES, INCLUDING THE DEVELOPMENT OR PRODUCTION OF WEAPONS OF MASS DESTRUCTION, THE DEVELOPMENT OR PRODUCTION OF CHEMICAL OR BIOLOGICAL WEAPONS, ANY ACTIVITIES IN THE CONTEXT RELATED TO ANY NUCLEAR EXPLOSIVE OR UNSAFE NUCLEAR FUEL-CYCLE, OR IN SUPPORT OF HUMAN RIGHTS ABUSES.

IN THE EVENT OF ANY CONFLICTS BETWEEN THIS MANUAL AND THE APPLICABLE LAW, THE LATER PREVAILS.

Regulatory Information

FCC Information

Please take attention that changes or modification not expressly approved by the party responsible for compliance could void the user's authority to operate the equipment.

FCC compliance: This equipment has been tested and found to comply with the limits for Class A device, pursuant to part 15 of the FCC Rules. These limits are designed to provide reasonable protection against harmful interference when the equipment is operated in a commercial environment. This equipment generates, uses, and can radiate radio frequency energy and, if not installed and used in accordance with the instruction manual, may cause harmful interference to radio communications. Operation of this equipment in a residential area is likely to cause harmful interference in which case the user will be required to correct the interference at his own expense.

FCC Conditions

This device complies with part 15 of the FCC Rules. Operation is subject to the following two conditions:

1. This device may not cause harmful interference.
2. This device must accept any interference received, including interference that may cause undesired operation.

EU Conformity Statement



This product and - if applicable - the supplied accessories too are marked with "CE" and comply therefore with the applicable harmonized European standards listed under the EMC Directive 2014/30/EU, the RoHS Directive 2011/65/EU.



2012/19/EU (WEEE directive): Products marked with this symbol cannot be disposed of as unsorted municipal waste in the European Union. For proper recycling, return this product to your local supplier upon the purchase of equivalent new equipment, or dispose of it at designated collection points. For more information see: www.recyclethis.info.





2006/66/EC (battery directive): This product contains a battery that cannot be disposed of as unsorted municipal waste in the European Union. See the product documentation for specific battery information. The battery is marked with this symbol, which may include lettering to indicate cadmium (Cd), lead (Pb), or mercury (Hg). For proper recycling, return the battery to your supplier or to a designated collection point. For more information see: www.recyclethis.info.

Industry Canada ICES-003 Compliance

This device meets the CAN ICES-3 (A)/NMB-3(A) standards requirements.

Symbol Convention

The symbols that may be found in this document are defined as follows.

Symbol	Description
 NOTE	Provides additional information to emphasize or supplement important points of the main text.
 WARNING	Indicates a potentially hazardous situation, which if not avoided, could result in equipment damage, data loss, performance degradation, or unexpected results.
 DANGER	Indicates a hazard with a high level of risk, which if not avoided, will result in death or serious injury.

Safety Instruction

These instructions are intended to ensure that user can use the product correctly to avoid danger or property loss.

Laws and Regulations

- The lightning protection and grounding design of outdoor installation and wiring should be in compliance with the lightning protection requirements of the buildings and local laws and regulations.

- Use of the product must be in strict compliance with the local electrical safety regulations.

Storage

- Store the device in dry, well-ventilated, corrosive-gas-free, no direct sunlight, and no heating source environment. Neglect may cause fire hazard.
- To avoid heat accumulation, good ventilation is required for a proper operating environment.
- DO NOT touch the heat dissipation component to avoid burns.

Transportation

- Keep the device in original or similar packaging while transporting it.
- Keep all wrappers after unpacking them for future use. In case of any failure occurred, you need to return the device to the factory with the original wrapper. Transportation without the original wrapper may result in damage on the device and the company shall not take any responsibilities.
- DO NOT drop the product or subject it to physical shock. Keep the device away from magnetic interference.

Installation

- When the device is mounted on wall or ceiling, the device shall be firmly fixed.
- Avoid equipment installation on vibratory surface or places subject to shock (neglect may cause equipment damage).

Power Supply

- Make sure that the power has been disconnected before you wire, install, or disassemble the device.
- Input voltage should meet both the SELV (Safety Extra Low Voltage) and the Limited Power Source with 12 VDC, 24 VAC , or PoE (802.3af) according to the IEC60950-1 standard. Please refer to technical specifications for detailed information.
- Use the power adapter provided by qualified manufacturer. Refer to the product specification for detailed power requirements. It is recommended to provide independent power adapter for each device as adapter overload may cause over-heating or a fire hazard.

Battery

- DO NOT place the battery near heating or fire source. Avoid direct sunlight.
- Improper use or replacement of the battery may result in explosion hazard. Replace with the same or equivalent type only. Dispose of used batteries according to the instructions provided by the battery manufacturer.
- For long-term storage of the battery, make sure it is fully charged every half year to ensure the battery quality. Otherwise, damage may occur.

System Security

- You acknowledge that the nature of Internet provides for inherent security risks, and our company shall not take any responsibilities for abnormal operation, privacy leakage or other damages resulting from cyber attack, hacker attack,

however, our company will provide timely technical support if required.

- Please enforce the protection for the personal information and the data security as the device may be confronted with the network security problems when it is connected to the Internet. Please contact us when the device might exist network security risks.
- Please understand that you have the responsibility to configure all the passwords and other security settings about the device, and keep your user name and password.

Maintenance

- Clean the lens with soft and dry cloth or wiping paper to avoid scratching it.
- If the product does not work properly, please contact your dealer or the nearest service center. We shall not assume any responsibility for problems caused by unauthorized repair or maintenance.
- A few device components (e.g., electrolytic capacitor) require regular replacement. The average lifespan varies, so periodic checking is recommended. Contact your dealer for details.

Using Environment

- DO NOT expose the device to extremely hot, cold, dusty, corrosive, saline-alkali, or damp environments. Make sure the running environment meets the requirement of the device. The operating temperature shall be -40 °C to 65 °C (-40 °F to 149 °F),
- DO NOT aim the lens at the sun or any other bright light.

- Keep the camera away from liquid while in use.

Emergency

- If smoke, odor, or noise arises from the device, immediately turn off the power, unplug the power cable, and contact the service center.

User Manual of Device

Scan the QR code to view the latest user manual of device on your mobile phone. Note that mobile data charges may apply if Wi-Fi is unavailable.



0505241091206

Table of Contents

1 Appearance Description	3
1.1 Type I Camera Appearance.....	3
1.2 Type II Camera Appearance.....	5
1.3 Type III Camera Appearance.....	5
1.4 Type IV Camera Appearance	6
1.5 Cable Description	6
1.6 Interfaces of Junction Box	8
2 Installation.....	10
2.1 Install Memory Card.....	11
2.1.1 Install Type I Camera Memory Card	11
2.1.2 Install Type II and Type IV Camera Memory Card	13
2.1.3 Install Type III Camera Memory Card.....	14
2.2 Wide Range Coverage	15
2.3 Install Camera	17
2.3.1 Install Type I Camera	17
2.3.2 Install Type II and Type IV Camera	19
2.3.3 Install Type III Camera	22
2.4 Waterproof Measures (Optional)	27
2.4.1 Install Network Cable Waterproof Jacket.....	27
2.4.2 Waterproof Other Cables	28
3 Set the Network Camera over the LAN.....	29
3.1 Wiring	29
3.2 Activate the Camera.....	30
3.2.1 Activate via Web Browser	30
3.2.2 Activate via SADP Software	31
3.3 Modify the IP Address	33

4 Access via Web Browser	36
Appendix	39
Common Material Emissivity Reference.....	39

1 Appearance Description

There are four thermal & optical bi-spectrum network bullet cameras. Here are the overviews of Type I camera, Type II camera, Type III camera, and Type IV camera.

1.1 Type I Camera Appearance

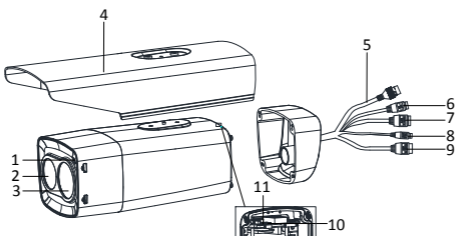

Figure 1-1 Type I Camera Appearance (1)

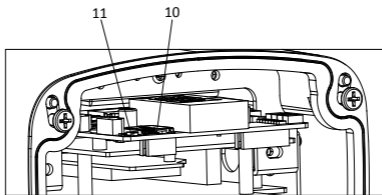

Figure 1-2 Type I Camera Appearance (2)

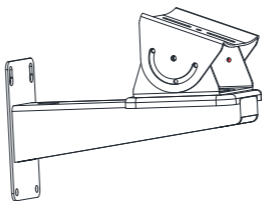

Figure 1-3 Wall Mounting Bracket (Optional)

Table 1-1 Description

No.	Description	No.	Description
1	Photoresistor	2	Lens (Optical)
3	Lens (Thermal)	4	Sun Shield
5	Network Cable	6	Power Supply Interface
7	Alarm Interface	8	RS-485
9	Audio Interface	10	Micro SD Card
11	Reset		

1.2 Type II Camera Appearance

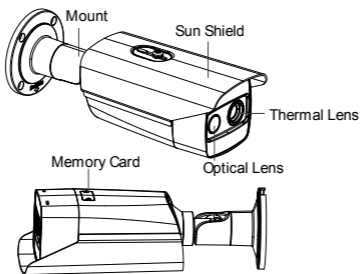

Figure 1-4 Type II Camera Appearance

1.3 Type III Camera Appearance

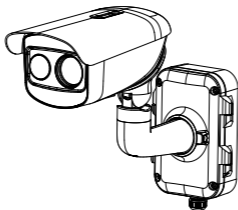

Figure 1-5 Type III Camera Appearance

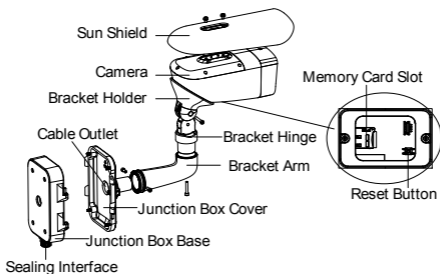

Figure 1-6 Type III Camera Cables

1.4 Type IV Camera Appearance

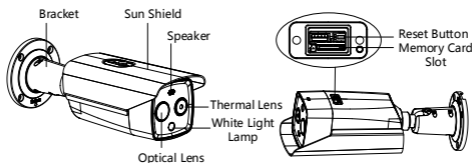

Figure 1-7 Type IV Camera Appearance

1.5 Cable Description

The bullet camera cables, including power cable, alarm cable, and audio cable are shown as figure below. The cable is

provided for certain camera models. Refer to the actual device.

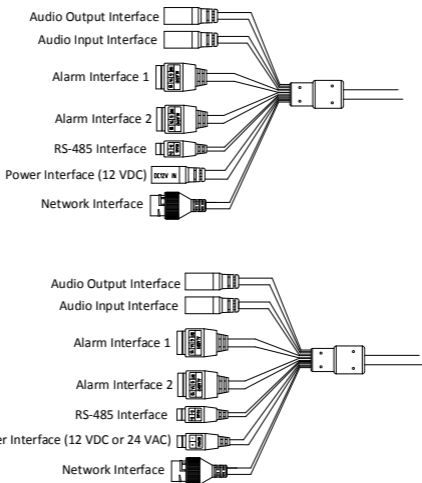

Figure 1-8 Cable Description

Table 1-2 Cable Description

Name	Description
Power Interface	For 12 VDC or 24 VAC power supply, make sure that the positive/negative terminals

Name	Description
	are connected correctly.
Network Interface	Connect to the LAN interface. PoE (802.3af) is supported.
Alarm Interface	Two-way alarm input and alarm output are supported. Alarm In: IN1, G/IN2, and G Alarm Out: 1A, 1B/2A, and 2B
Audio Interface	Audio In: Pickup Audio Out: Loudspeaker
RS-485 Interface	Control line.

 **NOTE**

- The cables may vary according to different models. Here we list all types of cables for reference. Take the actual product for the cables.
- Alarm cables can be classified as 2-ch alarm inputs and 2-ch alarm outputs. ALARM-IN1 and ALARM-IN2 are alarm input interfaces, and G indicates grounding interface. (1A, 1B) and (2A, 2B) indicate two alarm output interfaces.
- To reset the camera to default parameters, you need to hold the Reset button and power on the camera. After powering on the camera, you must still hold the Reset button for about 10 seconds.

1.6 Interfaces of Junction Box

For certain camera models, the power cable, alarm cable, network cable, and audio cable are connected to the

interfaces of the junction box. You can refer to the figure below for connection.

 **NOTE**

The junction box is different according to different models.

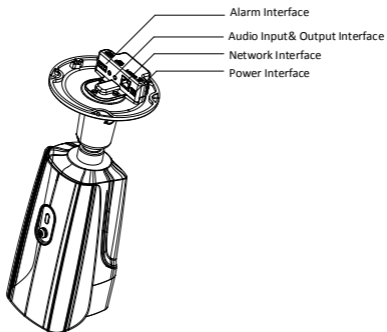

Figure 1-9 Interface Description

2 Installation

Before you start:

- Make sure the device in the package is in good condition and all the assembly parts are included.
- The standard power supply is 12 VDC, 24 VAC, or PoE (802.3af). Please make sure your power supply matches with your camera.
- Make sure all the related devices are powered off during the installation.
- Check the specification of the products for the installation environment.
- Make sure that the wall is strong enough to withstand four times the weight of the camera and the bracket.

For the camera that supports IR, pay attention to the following precautions to prevent IR reflection:

- Dust or grease on the camera cover will cause IR reflection. Please **DO NOT** remove the camera cover film until the installation is finished. If there is dust or grease on the camera cover, clean the camera cover with clean soft cloth and isopropyl alcohol.
- Make sure that there is no reflective surface too close to the camera lens. The IR light from the camera may reflect back into the lens causing reflection.
- **DO NOT** drag the camera with its waterproof cables, or the waterproof performance is affected.

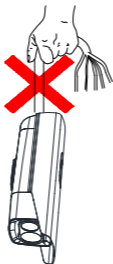

2.1 Install Memory Card

2.1.1 Install Type I Camera Memory Card

Steps:

1. Unscrew and remove the sun shield.

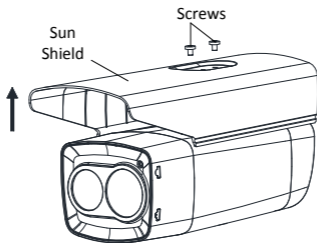

Figure 2-1 Remove Sun Shield

2. Unscrew and remove the back cover.

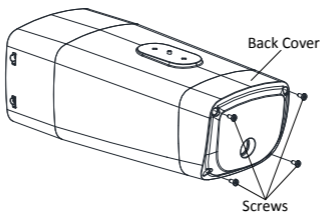

Figure 2-2 Remove Back Cover Case

3. Insert a micro SD card into the micro SD card slot.

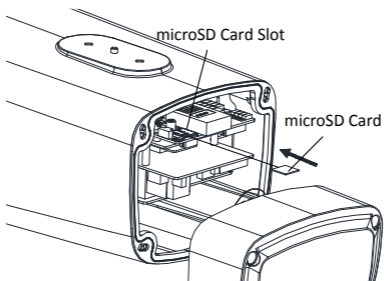

Figure 2-3 Insert micro SD Card

4. Fix the sun shield and back cover to the camera body with the removed screws.

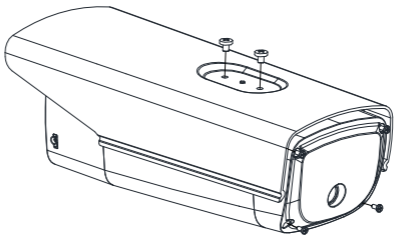

Figure 2-4 Fix Sun Shield and Back Cover

2.1.2 Install Type II and Type IV Camera Memory Card

The memory cards of Type II and Type IV camera are installed in the same way. Here is an example of memory card installation for type II camera.

Steps:

1. Unscrew and remove the memory card slot cover.

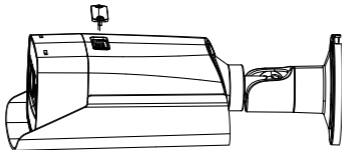

Figure 2-5 Remove Card Slot Cover

2. Insert a micro SD card into the micro SD card slot until the card clicks.

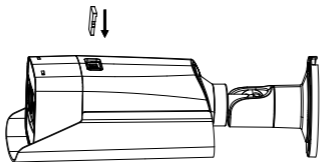

Figure 2-6 Insert micro SD Card

3. Cover the memory card slot and fix the screws on the memory card slot cover.

2.1.3 Install Type III Camera Memory Card

Steps:

1. Unscrew the memory card slot cover and remove it.

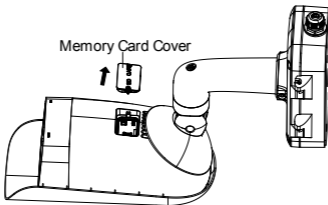

Figure 2-7 Remove Card Slot Cover

2. Insert the memory card into the memory card slot.

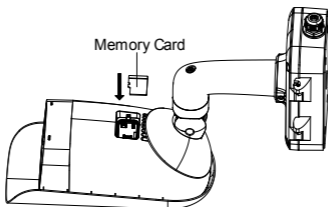

Figure 2-8 Insert Memory Card

3. Cover the memory card slot and fix the screws on the memory card slot cover.

2.2 Wide Range Coverage

Select the proper installation site and proper lens focal length according to the Wide Range Coverage list below:

Table 2-1 Wide Range Coverage

Lens (focal length)	3 mm	6 mm	7 mm	10 mm	15 mm	25 mm	35 mm
Detection range (Vehicles)	280 m	559 m	631 m	902 m	1353 m	2255 m	3157 m
Detection range (Humans)	91 m	182 m	206 m	294 m	441 m	735 m	1029 m
Recognition range (Vehicles)	70 m	140 m	158 m	225 m	338 m	564 m	789 m
Recognition range (Humans)	23 m	46 m	51 m	74 m	110 m	184 m	257 m

Quick Start Guide of Thermal & Optical Bi-spectrum Network Bullet Camera

Identification range (Vehicles)	35 m	70 m	79 m	113 m	169 m	282 m	395 m
Identification range (Humans)	11 m	23 m	26 m	37 m	55 m	92 m	129 m

Take human as 0.5 m (width) × 1.8 m (height), and limit length is 0.75 m. The vehicle limit length is 2.3 m.

- Detect target: The target should be at least 1.5 pixels on the image.
- Recognize target: The target should be at least 6 pixels on the image.
- Identify target: The target should be at least 12 pixels on the image.

NOTE

This table is for reference only, and the actual detection range may vary according to different camera settings, mounting condition, monitor, and so on.

2.3 Install Camera

2.3.1 Install Type I Camera

Steps:

1. Fix the bullet camera with the mounting bracket with expansion screws or bolts, as shown in Figure 2-9.

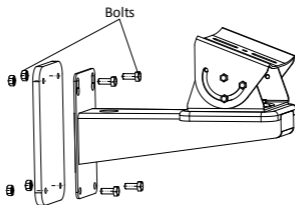

Figure 2-9 Install the Bracket onto the Wall

2. Fix the bullet camera to the mounting bracket with the supplied screws, as shown in Figure 2-10.

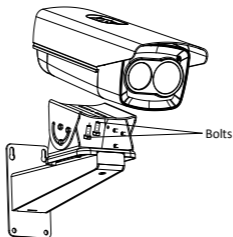

Figure 2-10 Fix the Camera to the Bracket

3. Bolt the camera body to the bracket.

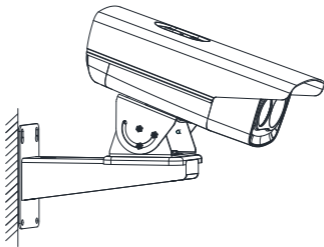

Figure 2-11 Fix the Camera to the Wall

4. Adjust the camera to the optimal surveillance angle.

- 1) Loosen the pan adjusting screw to adjust panning position [0° to 360°]. Tighten the screw.

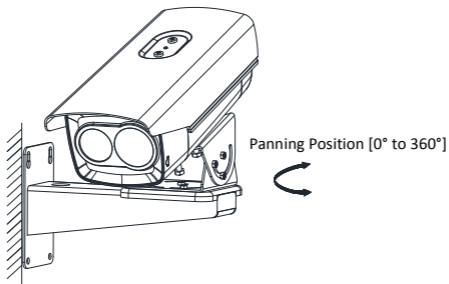

Figure 2-12 Pan Adjustment

- 2) Loosen the tile adjusting screw to adjust the tilting position [-45° to 45°]. Tighten the screw.

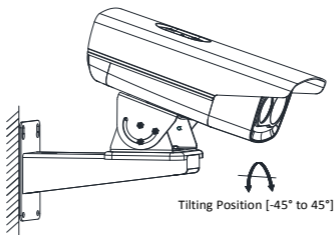

Figure 2-13 Tilt Adjustment

 **NOTE**

Please loosen the screws slightly until you can adjust the camera.
DO NOT remove the screws from the bracket.

2.3.2 Install Type II and Type IV Camera

Type II and Type IV cameras are installed in the same way. Here is an example of installation for type II camera.

Steps:

1. Select the proper place, and attach the drill template onto the wall/ceiling, as shown in Figure 2-9.



Figure 2-14 Drill Template

2. (Optional) For cement walls, drill four $\Phi 5$ installation holes according to the template (recommended depth: 25 mm) and insert the expansion screws. Otherwise, skip the step.
3. Drill a cable hole in the center.
4. Install the bullet camera with the screws (supplied).

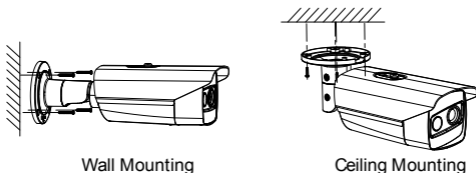

Figure 2-15 Wall/Ceiling Mounting

5. Adjust the camera to the optimal surveillance angle.

Bracket type I:

- 1) Loosen the tilt adjusting screw to adjust tilting position [0° to 360°]. Tighten the screw.
- 2) Loosen the pan adjusting screw to adjust the panning position [-45° to 45°]. Tighten the screw.
- 3) Loosen the rotation adjusting screw to rotate the camera [0° to 360°]. Tighten the screw.

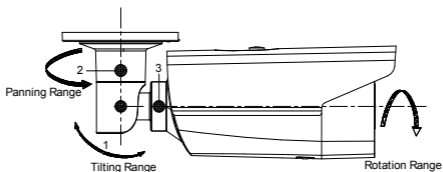

Figure 2-16 3-Axis Adjustment

Bracket type II:

- 1) Loosen the screw to adjust the tilting position [0° to 90°]. Tighten the screw.
- 2) Loosen the screw to adjust the rotation position [0° to 360°]. Tighten the screw.

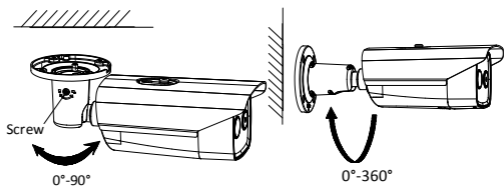

Figure 2-17 2-Axis Adjustment

2.3.3 Install Type III Camera

Before you start:

There are three methods of Type III camera installation: wall mounting, ceiling mounting, and stand mounting.

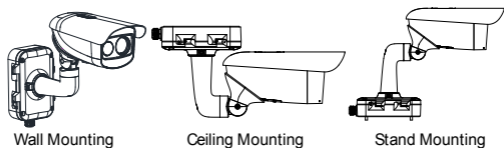

Figure 2-18 Type III Camera Installation Methods

Steps:

1. Loosen the screws on the junction box cover.
2. Draw the latches from the latch hole of the junction box and take apart the cover from the junction box.

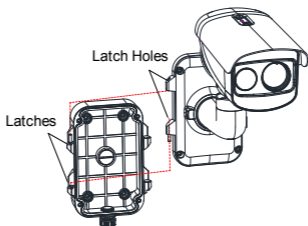

Figure 2-19 Take Apart Junction Box

3. Attach the drill template (supplied) to the place where you want to fix the camera, and then drill four screw holes (recommended depth: 40mm) in the ceiling/wall according to the drill template.
4. Drill a cable hole according to the *A* mark of the drill template.

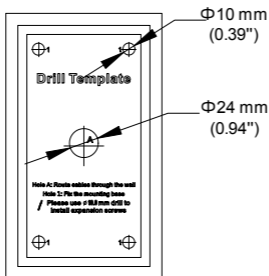

Figure 2-20 Drill Template

- Align the hole of drill template with the screw hole of the junction box base to place the junction box onto the wall.
- Route the screw through the sealing ring, and fix the junction box base on the wall with the screws.

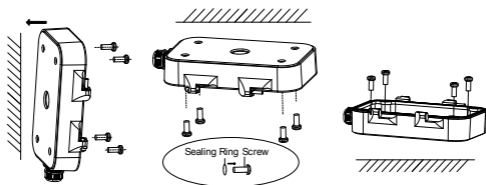

Figure 2-21 Install Junction Box Base

- Route the cables through the cable hole.
- Insert the latches into the latch holes to fix the bracket and camera with the junction box.



Figure 2-22 Install Junction Box Cover

- Fix the delivered screws to secure the junction box.

10. Connect the corresponding cables to power on the camera and get the live view.

11. Adjust the camera according to the figure below.

- 1) Loosen the rotation adjusting screw to rotate the camera [-180° to 180°]. Tighten the screw.

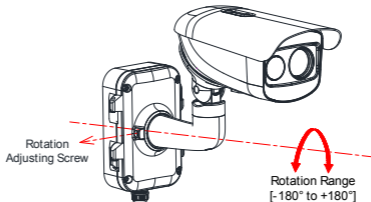

Figure 2-23 R-Axis Adjustment

- 2) Loosen the tilt adjusting screw to adjust tilting position [-90° to 55°]. Tighten the screw.

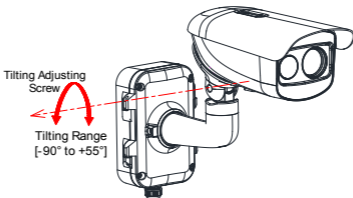

Figure 2-24 T-Axis Adjustment

- 3) Loosen the pan adjusting screw to adjust the panning position [-90° to 90°]. Tighten the screw.

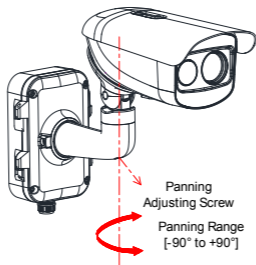

Figure 2-25 P-Axis Adjustment

2.4 Waterproof Measures (Optional)

Purpose:

If the camera is installed outdoor, you should use the waterproof accessory or tapes to waterproof the cables. Otherwise the cables might get wet or a short circuit might occur.

2.4.1 Install Network Cable Waterproof Jacket

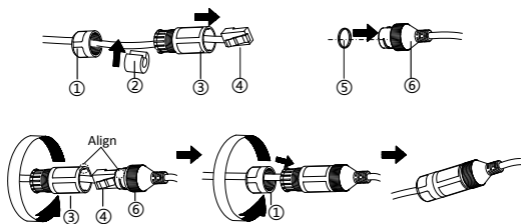

Figure 2-26 Install Waterproof Jacket

Steps:

1. Feed the network cable through ① and ③ in order.
2. Fix ② on the network cable between ① and ③.
3. Place ⑤ onto the end of ⑥, and plug the RJ45 male connector into RJ45 female connector.
4. Screw ③ to ⑥ clockwise.
5. Push ② into ③.
6. Secure ① with the ③ in clockwise direction.

2.4.2 Waterproof Other Cables

After routing and connecting the cables, use the waterproof tapes to wrap up the cables. Connected cables and spare cables both should be wrapped up as the figures below.

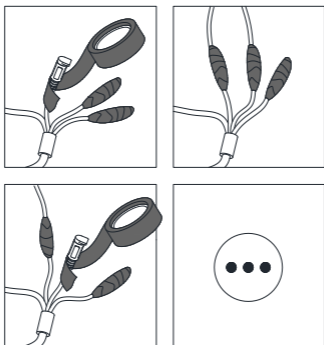

Figure 2-27 Waterproof Cables

3 Set the Network Camera over the LAN

NOTE

You shall acknowledge that the use of the product with Internet access might be under network security risks. For avoidance of any network attacks and information leakage, please strengthen your own protection. If the product does not work properly, please contact with your dealer or the nearest service center.

3.1 Wiring

Please connect to the camera to the network according to the following figures



Figure 3-1 Connect Directly

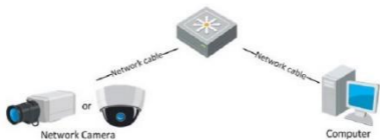

Figure 3-2 Connect via a Switch or a Router

3.2 Activate the Camera

You are required to activate the camera first by setting a strong password for it before you can use the camera.

Activation via Web Browser, Activation via SADP, and Activation via Client Software are all supported. We will take activation via SADP software and Activation via Web Browser as examples to introduce the camera activation. Please refer to the User Manual of Network Camera for Activation via Client Software.

3.2.1 Activate via Web Browser

Steps:

2. Power on the camera, and connect the camera to the network.
3. Input the IP address into the address bar of the web browser, and click Enter to enter the activation interface.

NOTE

- The default IP address of the camera is 192.168.1.64.
- For the camera enables the DHCP by default, you need to activate the camera via SADP software and search the IP address.



Figure 3-3 Activation Interface(Web)

4. Create a password and input the password into the password field.



We highly recommend you create a strong password of your own choosing (using a minimum of 8 characters, including upper case letters, lower case letters, numbers, and special characters) in order to increase the security of your product. And we recommend you reset your password regularly, especially in the high security system, resetting the password monthly or weekly can better protect your product.

5. Confirm the password.
6. Click **OK** to save the password and enter the live view interface.

3.2.2 Activate via SADP Software

SADP software is used for detecting the online device, activating the camera, and resetting the password.

Get the SADP software from the supplied disk or the official website, and install the SADP according to the prompts. Follow the steps to activate the camera, please refer to the User Manual of Network Camera for other two activation methods.

Steps:

1. Run the SADP software to search the online devices.
2. Check the device status from the device list, and select the inactive device.

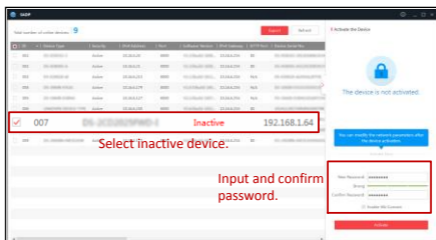

Figure 3-4 SADP Interface

NOTE

The SADP software supports activating the camera in batch. Please refer to the user manual of SADP software for details.

3. Create a password and input the password in the password field, and confirm the password.



We highly recommend you create a strong password of your own choosing (using a minimum of 8 characters, including upper case letters, lower case letters, numbers, and special characters) in order to increase the security of your product. And we recommend you reset your password regularly, especially in the high security system, resetting the password monthly or weekly can better protect your product.

4. Click **OK**.

You can check whether the activation is completed on the popup window. If activation failed, please make sure that the password meets the requirement and try again.

3.3 Modify the IP Address

Purpose:

To view and configure the camera via LAN (Local Area Network), you need to connect the network camera in the same subnet with your PC. Then, install the SADP software or client software to search and change the IP of network camera. We will take modifying the IP Address via SADP software as an example to introduce the IP address modification.

Steps:

1. Run the SADP software.
2. Select an active device.

**NOTE**

Please refer to Chapter 3.2 to activate the camera if the camera is inactive.

3. Change the device IP address to the same subnet with your computer by either modifying the IP address manually or checking **Enable DHCP**.

Modify Network Parameters

Enable DHCP
 Enable Hik-Connect

Device Serial No.: XXX-XXXXXXXX-XXXXXXXXXXXXXXXXXX

IP Address: 192.168.1.64

Port: 8000

Subnet Mask: 255.255.255.0

Gateway: 192.168.1.1

IPv6 Address: ::

IPv6 Gateway: ::

IPv6 Prefix Length: 0

HTTP Port: 80

Security Verification

Admin Password:

[Modify](#)

[Forgot Password](#)

Figure 3-5 Modify the IP Address

4. Input the password to activate your IP address modification.

The batch IP address modification is supported by the SADP. Please refer to the User Manual of SADP for details.

4 Access via Web Browser

System Requirement:

Operating System: Microsoft Windows XP SP1 and above version

CPU: 2.0 GHz or higher

RAM: 1G or higher

Display: 1024×768 resolution or higher

Web Browser: Internet Explorer 8.0 and above version, Apple Safari 5.0.2 and above version, Mozilla Firefox 5.0 and above version and Google Chrome 18 and above version

Steps:

1. Open the web browser.
2. In the browser address bar, input the IP address of the network camera, and press **Enter** to enter the login interface.



- The default IP address is 192.168.1.64.
 - If the camera is not activated, please activate the camera first according to Chapter 3.2.
3. Input the user name and password.

The admin user should configure the device accounts and user/operator permissions properly. Delete the unnecessary accounts and user/operator permissions.



The device IP address gets locked if the admin user performs 7 failed password attempts (5 attempts for the user/operator).

4. Click **Login**.



Figure 3-6 Login Interface

5. Install the plug-in before viewing the live video and managing the camera. Please follow the installation prompts to install the plug-in.



NOTE

You may have to close the web browser to finish the installation of the plug-in.

[Please click here to download and install the plug-in. Close the browser when installing the plug-in.](#)

Figure 3-7 Download Plug-in

6. Reopen the web browser after the installation of the plug-in and repeat steps 2-4 to login.



NOTE

For detailed instructions of further configuration, please refer to the user manual of network camera.

Appendix

Common Material Emissivity Reference

Material	Emissivity
Human Skin	0.98
PCB	0.91
Cement Concrete	0.95
Ceramics	0.92
Rubber	0.95
Paint	0.93
Wood	0.85
Asphalt	0.96
Brick	0.95
Sand	0.90
Soil	0.92
Cotton	0.98
Cardboard	0.90
White Paper	0.90
Water	0.96

