



IDEAL NETWORKS

FiberTEK III





COPYRIGHT NOTICE

The information contained in this document is the property of IDEAL INDUSTRIES Ltd. and is supplied without liability for errors and omissions. No part of this document may be reproduced or used except as authorized by contract or other written permission from IDEAL INDUSTRIES Ltd. The copyright and all restrictions on reproduction and use apply to all media in which this information may be placed.

IDEAL INDUSTRIES Ltd. pursues a policy of continual product improvement and reserves the right to alter without notice the specification, design, price or conditions of supply of any product or service.

© IDEAL INDUSTRIES LTD. 2016

All rights reserved

Publication ref: 164802

Issue 4 - 02/2016

(Applies to LanTEK III software revision 3.067 onwards)

IDEAL INDUSTRIES LTD.
Stokenchurch House
Oxford Road
Stokenchurch
High Wycombe
Buckinghamshire
HP14 3SX UK

www.idealnetworks.net

Safety Precautions



WARNING!

NEVER look directly into the port of measuring adapter, at connector surface, open fiber ends or into couplers. There is a risk of light emerging from the fiber that is not visible, which could permanently damage your eyes.

If you are not sure whether the device is switched on or whether the fiber transmits light, for safety reasons always assume that the device is active.

Handle bare fibers properly; there is a risk of injury from fiber splinters.

Protect your eyes when working with bare fibers; fiber splinters could permanently damage your eyes.

Never let fiber scraps lie openly and never dispose of them loosely in normal waste containers; there is a risk of injury from fiber splinters.



CAUTION!

When connecting the measuring adapter to a light-conducting line, the maximum measuring range must be observed (see specifications of individual modules). Exceeding it could result in damages to FiberTEK™ III modules.

NOTE:

Before connecting cable adapter to FiberTEK™ III adapter, ensure that the plugs of cable connectors are clean.

Clean ferrules of measuring adapter only with dry, lint-free, non-abrasive materials.

The plugs can be cleaned with suitable fiber cleaning cloths or cleaning pens. IDEAL recommends cleaning set #1219-00-1621025205 (2.5 mm) and 025204 (1.25 mm) to care for the modules and patch cord.

Disclaimer

IDEAL INDUSTRIES, LTD. does not assume any liability for death, injury or damage to equipment or property resulting from improper use of the battery packs.

IDEAL INDUSTRIES, LTD. will not be liable for consequential damages that may result from tampering with the battery packs or charger or their use thereafter.

Subject to technical changes.

Environmental Protection

If you have any questions concerning these precautions, the operating instructions, or any other concerns about the safe use and disposal of the battery packs used in LanTEK® III, please contact a representative of IDEAL INDUSTRIES, LTD.



Information on the use of this Instruction Manual

The following symbols used in this manual indicate that the user should exercise particular caution in order to prevent personal injury or damage to the FiberTEK™ III or the system under test.



WARNING!

This symbol indicates potentially lethal voltages or dangerous situations. The life and/or health of the person performing the activity or anybody in the vicinity is at risk.



CAUTION!

This symbol indicates that the relative activity could possibly harm the environment or damage technical equipment.

NOTE:

Here you will find general notes, additional information, or support.

Typographical Conventions

- **Boldface** Refers to a button on LanTEK III Cable Certifier.
- *Italics* Refers to a menu option in this Operating Manual.
- Quotation marks " " identify a "Screen Message".

CONTENTS

Chapter 1. Specifications	5
Chapter 2. Product Description.....	8
2.1 Test Modules.....	8
2.1.1 Controls, Ports, Indicators and Connectors.....	8
2.2 Fiber Adapters	10
2.3 Encircled Flux	10
Chapter 3. Calibration	11
3.1 Field Calibration	11
3.2 Performing Field Calibration.....	11
Chapter 4. Testing using FiberTEK™ III	14
4.1 Test Setup According to Reference Method with Three Test Cords	14
4.2 Test Setup According to Reference Method with One Test Cord.....	14
4.3 Set Autotest Pref.....	15
4.3.1 Selection of Fiber Test Standard	15
4.3.2 Selection of Refractive Index.....	16
4.3.3 Selection of Fiber size and Wavelength	16
4.3.4 Determine Loss Budget.....	17
4.4 Evaluation of Autotest Results for Fibers (LWL).....	18
4.4.1 Passed/Failed Rating	18
4.4.2 Saving Current Autotest Results.....	18
4.4.3 Manual Saving of Autotest Results (Autosave off).....	19
4.4.4 Working with Jobs	19
4.4.5 Display of Result Details	19
Chapter 5. FiberTEK™ III Analyse Mode	20
5.1.1 Continuous Run	20
5.1.2 Power Meter Mode	21



Chapter 1. Specifications

Operational Conditions (unless specified otherwise)	1. At 23 ±1 °C unless otherwise specified. 2. After ten-minute warm-up time.
Testing speed	Autotest 8 seconds for each fiber / fiber pair (i.e. twice this for a Bi-Directional test)
Input (Meter) connectors	Universal with adaptors for FC, ST, SC and LC
Output (Source) connectors	Universal with adaptors for FC, ST, SC and LC
Fiber type	9/125 μm, 50/125 μm and 62.5/125 μm
Source type and nominal wavelength	MM LED: 850 nm LED and 1300 nm LED SM Laser: 1310 nm and 1550 nm FP laser
Source wavelengths	MM: 850 ±20 nm 1300 nm -35 to +30 nm SM: 1310 ±20 nm 1550 nm ±30 nm
Source spectral width	MM LED: Source spectral width (Full-Width Half-Maximum - FWHM): 35 nm at 850 nm typical 80 nm at 1300 nm typical
Source power in light source mode	MM 850 nm LED: -20 to -23 dBm nominal With EF mode conditioner: -23 to -26 dBm nominal MM 1300 nm LED: -15 to -20 dBm With EF mode conditioner: -18 to -23 dBm SM Laser: > -7 dBm
Source power stability	850, 1300 nm LED: ±0.25 dBm over 8 hours 1310, 1550 nm Lasers: ±0.25 dBm over 8 hours
Encircled Flux Compliance	Using optional external mode conditioner, complies with TIA-526-14-B and IEC 61280-1-4 at the end of the cable
Length measurement	MM LED: 0 - 7,500 m of 50/125 or 62.5/125 μm fiber SM Laser: : 0 - 20,000 m 9/125 μm fiber
Length measurement accuracy	±1.5 m ±2% of length, 2 m minimum
Power meter type	InGaAs detector
Power meter calibrated wavelengths	MM: 850 nm, 1300nm SM: 1310 nm, 1550 nm
Power measurement range	0 to -55 dBm (850 nm) 0 to -60 dBm (1300/1310 nm and 1550 nm)
Power measurement uncertainty (accuracy)	±0.25 dB at - 20 dBm, calibration performed with an FC adaptor
Measurement linearity	<ul style="list-style-type: none"> •850 nm: target ±0.2 dB between 0 and -45 dBm, ± 0.25 dB below -45 dBm •1300/1310 nm and 1550 nm: target ±0.2 dB between 0 and -55 dBm, ± 0.2 dB below -55 dBm
Display resolution	Power/attenuation: 0.01dB or dBm Power W: 3 digits 1.00 to 9.99 nW 10.0 to 99.9 nW 100 to 999 nW 1.00 to 9.99 uW 10.0 to 99.9 uW 100 to 999 uW Length: 0.1m / 0.5ft
Display update rate	Approximately 2 updates per second on power meter function



Summary of Fiber Optic Cabling Standards & Application Requirements

Standards Organization	Classification or Application	Fiber Type	Core size (um) / wavelength (nm)	Max Link Channel Loss (dB)	Max Connector Insertion Loss (dB)	Max Splice Insertion Loss (dB)	Min Connector Return Loss (dB)	Maximum Distance (m)	Min Operating Distance (m) (50um/62.5um)	Max Fiber Attenuation (dB/km)	Min Fiber Bandwidth (MHz-km)
TIA 568-B.3 Generic Cabling	Horizontal link	Multimode	62.5/850	n/s	0.75	0.3	>20	90	n/s	3.5	160
	Horizontal link	Multimode	50/850	n/s	0.75	0.3	>20	90	n/s	3.5	500
	Horizontal link	Multimode	62.5/1300	n/s	0.75	0.3	>20	90	n/s	1.5	500
	Horizontal link	Multimode	50/1300	n/s	0.75	0.3	>20	90	n/s	1.5	500
	Backbone	Multimode	62.5/850	n/s	0.75	0.3	>20	2km	n/s	3.5	160
	Backbone	Multimode	50/850	n/s	0.75	0.3	>20	2km	n/s	3.5	500
	Backbone	Multimode	62.5/1300	n/s	0.75	0.3	>20	2km	n/s	1.5	500
	Backbone	Multimode	50/1300	n/s	0.75	0.3	>20	2km	n/s	1.5	500
ISO 11801 Generic Cabling	Horizontal link	Single mode	9/1310	n/s	0.75	0.3	>26	90	n/s	1.0	n/a
	Horizontal link	Single mode	9/1550	n/s	0.75	0.3	>26	90	n/s	1.0	n/a
	Backbone (ISP)	Single mode	9/1310	n/s	0.75	0.3	>26	3km	n/s	1.0	n/a
	Backbone (ISP)	Single mode	9/1550	n/s	0.75	0.3	>26	3km	n/s	1.0	n/a
	Backbone - (OSP)	Single mode	9/1310	n/s	0.75	0.3	>26	3km	n/s	0.5	n/a
	Backbone - (OSP)	Single mode	9/1550	n/s	0.75	0.3	>26	3km	n/s	0.5	n/a
	OF-300	OM1	50 or 62.5/1300	1.95	0.75 ea/ 1.5 total	0.3	>20	n/s	300	1.5	500
	OF-300	OM2	50 or 62.5/850	2.55	0.75 ea/ 1.5 total	0.3	>20	n/s	300	3.5	500
ISO 11801 Generic Cabling	OF-300	OM2	50 or 62.5/1300	1.95	0.75 ea/ 1.5 total	0.3	>20	n/s	300	1.5	500
	OF-300	OM3	50/850	2.55	0.75 ea/ 1.5 total	0.3	>20	n/s	300	3.5	1500
	OF-300	OM3	50/1300	1.95	0.75 ea/ 1.5 total	0.3	>20	n/s	300	1.5	500
	OF-300	OS1	9/1310 or 1550	1.80	0.75 ea/ 1.5 total	0.3	>35	n/s	300	1.0	n/s
	OF-500	OM1	50 or 62.5/850	3.25	0.75 ea/ 1.5 total	0.3	>20	n/s	500	3.5	200
	OF-500	OM1	50 or 62.5/1300	2.25	0.75 ea/ 1.5 total	0.3	>20	n/s	500	1.5	500



Standards Organization	Classification or Application	Fiber Type	Core size (um) / wavelength (nm)	Max Link Channel Loss (dB)	Max Connector Insertion Loss (dB)	Max Splice Insertion Loss (dB)	Min Connector Return Loss (dB)	Maximum Distance (m)	Min Operating Distance (m) (50um/62.5um)	Max Fiber Attenuation (dB/km)	Min Fiber Bandwidth (MHz-km)
ISO 11801 Generic Cabling	OF-500	OM2	50 or 62.5/850	3.25	0.75 ea/ 1.5 total	0.3	>20	n/s	500	3.5	500
	OF-500	OM2	50 or 62.5/1300	2.25	0.75 ea/ 1.5 total	0.3	>20	n/s	500	3.5	500
	OF-500	OM3	50/850	3.25	0.75 ea/ 1.5 total	0.3	>20	n/s	500	3.5	1500
	OF-500	OM3	50/130	2.25	0.75 ea/ 1.5 total	0.3	>20	n/s	500	1.5	500
	OF-500	OS1	9/1310 or 1550	2.00	0.75 ea/ 1.5 total	0.3	>35	n/s	500	1.0	n/a
	OF-2000	OM1	50 or 62.5/850	8.50	0.75 ea/ 1.5 total	0.3	>20	n/s	2km	3.5	200
	OF-2000	OM1	50 or 62.5/1300	4.50	0.75 ea/ 1.5 total	0.3	>20	n/s	2km	1.5	500
	OF-2000	OM2	50 or 62.5/850	8.50	0.75 ea/ 1.5 total	0.3	>20	n/s	2km	3.5	500
	OF-2000	OM2	50 or 62.5/1300	4.50	0.75 ea/ 1.5 total	0.3	>20	n/s	2km	1.5	500
	OF-2000	OM3	50/850	8.50	0.75 ea/ 1.5 total	0.3	>20	n/s	2km	3.5	1500
	OF-2000	OM3	50/130	4.50	0.75 ea/ 1.5 total	0.3	>20	n/s	2km	1.5	500
	OF-2000	OS1	9/1310 or 1550	3.50	0.75 ea/ 1.5 total	0.3	>35	n/s	2km	1.0	n/a
	IEEE 802.3	10Base-FL	Multimode/ OM1-OM2	62.5/850	12.50	0.75 ea/ 1.5 total	n/s	>20	2km	0	3.75
10Base-FL		Multimode/ OM1-OM3	50/850	12.50	0.75 ea/ 1.5 total	n/s	>20	1.5km	0	3.75	160
100Base-FX		Multimode/ OM1-OM3	62.5 or 50/1300	11.00	0.75 ea/ 1.5 total	n/s	n/s	2km	0	3.75	500
1000Base-SX		Multimode/ OM1-OM2	62.5/850	2.33	0.75 ea/ 1.5 total	n/s	>20	n/s	220	3.75	160
1000Base-SX		Multimode/ OM2-OM3	62.5/850	2.53	0.75 ea/ 1.5 total	n/s	>20	n/s	275	3.75	200
1000Base-SX		Multimode/ OM1-OM3	50/850	3.25	0.75 ea/ 1.5 total	n/s	>20	n/s	500	3.5	400
1000Base-SX		Multimode/ OM2-OM3	50/850	3.43	0.75 ea/ 1.5 total	n/s	>20	n/s	550	3.5	500
1000Base-LX		Multimode/ OM1-OM2	62.5/1300	2.32	0.75 ea/ 1.5 total	n/s	>20	n/s	550	1.5	500
1000Base-LX		Multimode/ OM1-OM2	50/1300	2.32	0.75 ea/ 1.5 total	n/s	>20	n/s	550	1.5	400/500
1000Base-LX		Singlemode/ OS1	9/1310	4.50	0.75 ea/ 1.5 total	n/s	>26	n/s	5km	0.5	n/a
10GBase-SR		Multimode- OM1	62.5/850	2.60	0.75 ea/ 1.5 total	n/s	>20	n/s	26	3.5	160
10GBase-SR		Multimode- OM1	62.5/805	2.50	0.75 ea/ 1.5 total	n/s	>20	n/s	33	3.5	200
10GBase-SR		Multimode/ OM2-OM3	50/850	2.20	0.75 ea/ 1.5 total	n/s	>20	n/s	66	3.5	400

Chapter 2. Product Description

2.1 Test Modules

FiberTEK™ III is a fiber optic adaptor module for the IDEAL LanTEK III Cable Certifier. It is available as either Single-mode (SM) module or a Multimode (MM) module and may be used either singly in “looped” mode with LanTEK III Display handset or as a pair also using the Remote handset.

NOTE

Many of the generic functions of LanTEK III, such as Power, Jobs Management and Talk Mode, are available when FiberTEK™ III is in use. Please refer to LanTEK III documentation for further details.

The adaptor modules are hot-swappable, ie. they can be changed without switching the LanTEK III power off.

The two adaptor modules have an identical layout, as described below.

2.1.1 Controls, Ports, Indicators and Connectors

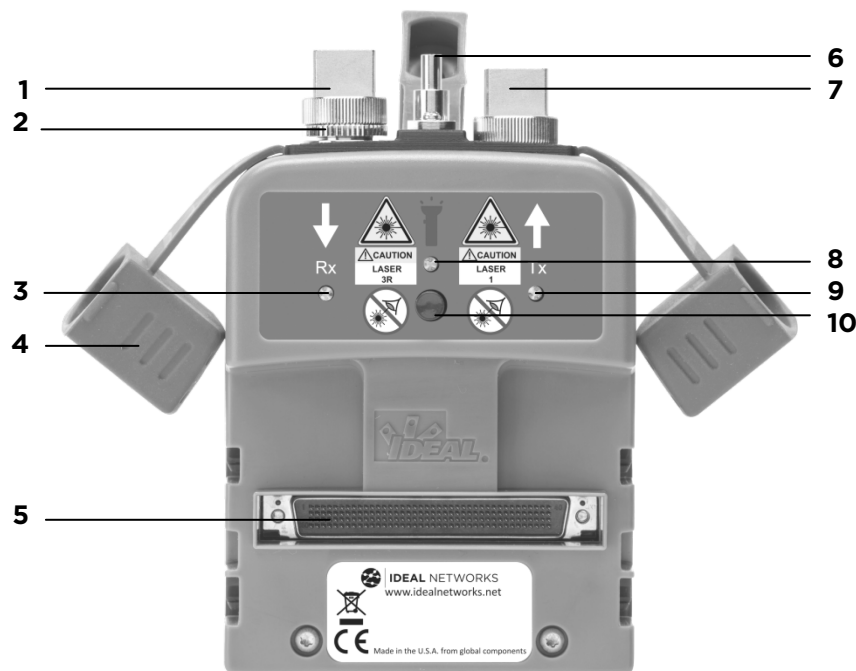



Fig. 1 The Single-mode FiberTEK™ III module



	Item	Description
1	Rx Port	Receiver port for cable testing and Power Meter input.
2	Rx Port adapter ring	Leave in place when using FC, SC or ST adapters. Remove when using LC adapters.
3	Rx Status LED	Dark: no light signal received Red blinking: light signal detected, but not recognised as from a FiberTEK™ III adaptor Green blinking: light signal detected and identified as from a FiberTEK™ III adaptor Green continuous: light signal received from FiberTEK™ III adaptor and communications between adaptor(s) established Note: This LED is useful for identifying which fiber is which in a duplex cable. It is not necessary to plug the fiber into the Rx Port to do this - bringing the fiber end near to the Rx Port is sufficient.
4	Protective caps	Always keep in place when the ports are not in use to protect against damage and dust.
5	System connector	Connection to LanTEK III
6	Red light source	Visible source for cable identification. 2.5mm universal ferrule.
7	Tx Port	Dual Wavelength Light Source. Note that the Tx signal is switched on by the system software and cannot be switched off by the user.  Do not look directly into the fiber end - it may be carrying a dangerous level of invisible light!
8	Visible Red light source status LED	Dark: Off Red: On
9	Tx Status LED	Dark: light source OFF Orange: 850 nm (MM) or 1550 nm (SM) source on Red: 1300 nm (MM) or 1310 nm (SM) source on
10	Visible Red light source switch	Press once: Visible light source blinks Press again: Visible light source On Press again: Visible light source Off Note: This function can be used to trace fibers by looking for the visible red light coming out of the end of a fiber or escaping from the jacket at a bend point.  Do not look directly into the fiber end - it may be carrying a dangerous level of invisible light!



2.2 Fiber Adapters

FiberTEK™ III modules are provided with interchangeable FC, SC and ST fiber adapters. Adapters for the Rx port and the Tx port are identical and interchangeable. All of the adapters have a screw fitting to attach them to the module. The Rx port is fitted with an adapter ring that should be kept in place when using FC, SC or ST adapters.



Fig. 2 Fiber Adapters

LC adapters are available optionally. The correct LC adapter must be used on the Tx Port - MM (Orange boot- part number 025202) / SM (Yellow boot - part number 025201). When using LC adapters, the adapter ring must first be removed from the Rx Port.

To remove an adapter, unscrew it anticlockwise.

Before fitting the new adapter, clean the inside of the ferrules in the port connector and in the adapter with a cotton bud. Fit the new adapter by screwing it clockwise.

2.3 Encircled Flux

By using the optional IDEAL 164050 (50/125 um SC to SC) or 164051 (50/125 um SC to LC) conditioning unit, the Tx signal from the Multimode module can be made to be Encircled Flux compliant as defined by IEC 62180-4-1 / TIA 455-526-14-B.

NOTE

The use of this conditioning unit introduces some Insertion Loss and therefore, before it is used, a Field Calibration must be performed, with the conditioning unit connected to the adaptor Tx port.

Chapter 3. Calibration

To comply with precision requirements, you should have your LanTEK III and FiberTEK™ III Cable Tester calibrated on an annual basis. Before sending the tester for calibration or maintenance, please contact the local Technical Customer Service of IDEAL INDUSTRIES at www.idealnetworks.net

3.1 Field Calibration

During calibration, FiberTEK™ III calculates a reference level for the loss measurement. Calibration accuracy depends on warm-up period of measuring adapter and quality of the test cords.

NOTE

The launch and tail cords must correspond to the type of fiber to be tested (e.g. 50- μ m launch fibers for testing of 50- μ m cable).

All connections on launch, tail and reference cords must be in compliance with the requirements of ISO/IEC 14763-3 concerning length as well as insertion loss.

To ensure the specified measuring accuracy, a sufficient warm up period must be allowed for the measuring adapter.

The temperature of LanTEK™ III Cable Tester and measuring adapter should correspond to the ambient temperature.

To prevent condensation on optics, do not remove dust covers on measuring adapters before performing cable test.

Close optical input/output again immediately with dust covers after removal of launch fibers.

The field calibration values are saved in the Display handset (DH). The loss of the launch fibers and couplers used during calibration are deducted from the loss results during the cable test.

Before testing of fibers a calibration should be performed if:

- the launch cords have been subject to change or strong movement;
- the fiber type has been changed;
- the measuring adapters have been changed;

3.2 Performing Field Calibration

1. Connect the reference patch cables between the Display handset (DH) and Remote handset (RH) (Normal mode) or looped on the Display handset (Loop mode).
2. Once connected, do not disconnect the Tx reference patch cable until testing on the target cables is complete.
3. Use **Arrow Keys** to navigate on ready screen to "Calibration" and press **Enter**.
4. Select required calibration method

NOTE

The Field Calibration should be performed using the same arrangement of jumpers as will be used in the tests.

1. Use **Arrow Keys** to navigate on ready screen to " Field Calibration" display and confirm with **Enter**.
2. Select the required method:



- In the 1-Jumper test method, the cable under test must be plugged directly into the Rx Port of the FiberTEK™ III. Field Calibration uses a single jumper (Launch Cord) for each direction.

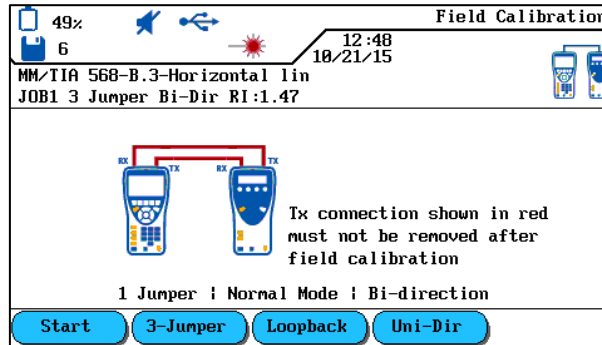

Fig. 3 One Jumper Field Calibration

- If it is not possible or practical to plug the cable under test directly into the Rx Port (for example if it is a Permanent Link) the 3-Jumper test method must be used instead. For Field calibration in this method, 3 jumpers are used in each direction - a Launch Cord, a Field Calibration Cord and a Tail Cord.

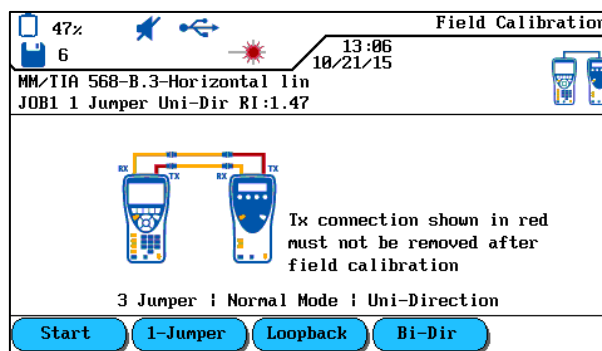

Fig. 4 Three Jumper Field Calibration

- For testing cables where both ends are available in one location, a Loopback method is provided. This method uses only the Display Handset. A 1-Jumper or a 3-Jumper Field calibration can be performed, depending on whether it is possible to plug the cable to be tested directly into the Tx and Rx Ports of the FiberTEK™ III .

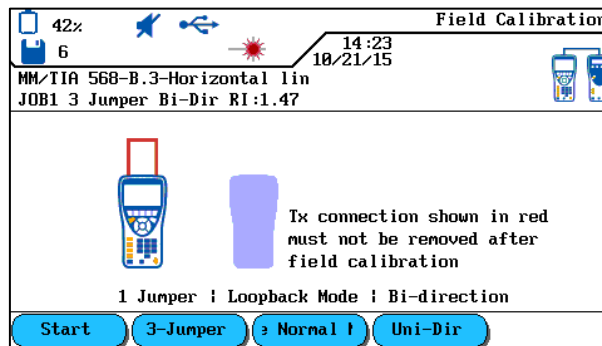

Fig. 5 Loopback Field Calibration (1-Jumper)

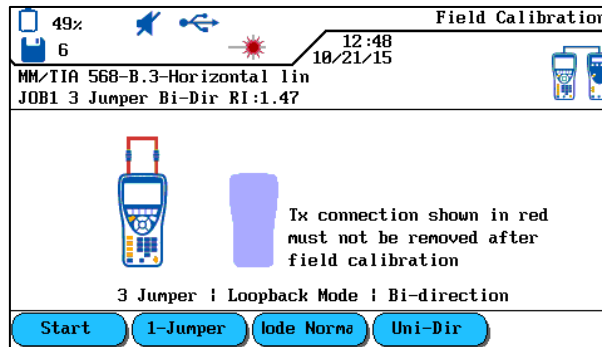

Fig. 6 Loopback Field Calibration (3-Jumper)

- Use the soft keys **Bi-Dir** / **Uni-Dir** to select whether to test a single cable in one direction or a duplex cable in both directions. (This setting does not affect the Field calibration.)
3. Use soft key **Start** to start the Field Calibration
 4. Follow the instructions on screen
 5. After the Field Calibration is complete, an indication of the quality of the jumper(s) used is shown:

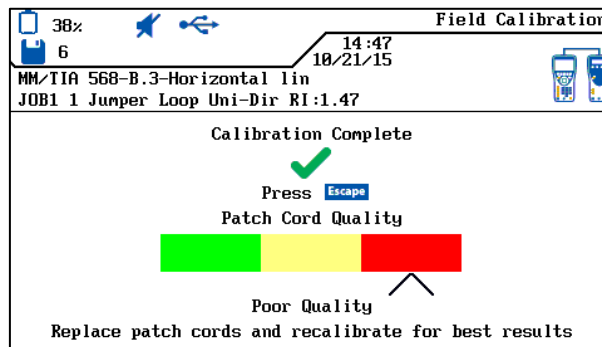

Fig. 7 Field Calibration result

NOTE

The cables connected to the Tx Ports must not be removed following calibration.

If field calibration was not successful, implement the following measures:

- Check correct connection of launch cords.
- Check launch fiber connections for contamination. If necessary, clean connections and check with a fiber test microscope (IDEAL order number 45-332).
- Dirty launch fibers also contaminate the measuring adapter connections. Clean the connections on the FiberTEK™ III measuring adapters with an optical cleaning sponge.
- Check launch cords with a fiber continuity tester (IDEAL order number: VFF5) for continuity.
- Replace suspected damaged launch cords.



Chapter 4. Testing using FiberTEK™ III

All cable parameter default settings programmed in the FiberTEK™ III Cable Certifier are based on generic standards, proposed industry recommendations for cables and network links, the latest technical information available from International LAN cabling standards committees, the LAN industry, and IDEAL INDUSTRIES' own experience and testing.

Before performing any measurements, IDEAL INDUSTRIES, LTD. recommends to request detailed information from contractor or project manager on the standards to be used for measuring, to ensure that relevant parameters are complied with.

4.1 Test Setup According to Reference Method with Three Test Cords

This is the preferred measuring method, based on ISO/IEC 14763-3, which can be used for any topology - both installation and transmission line. Irrespective of the plug face, it is also used on the measuring equipment and within the transmission line.

Calibration takes place via reference line between the launch cords and tail cords used for measurement.

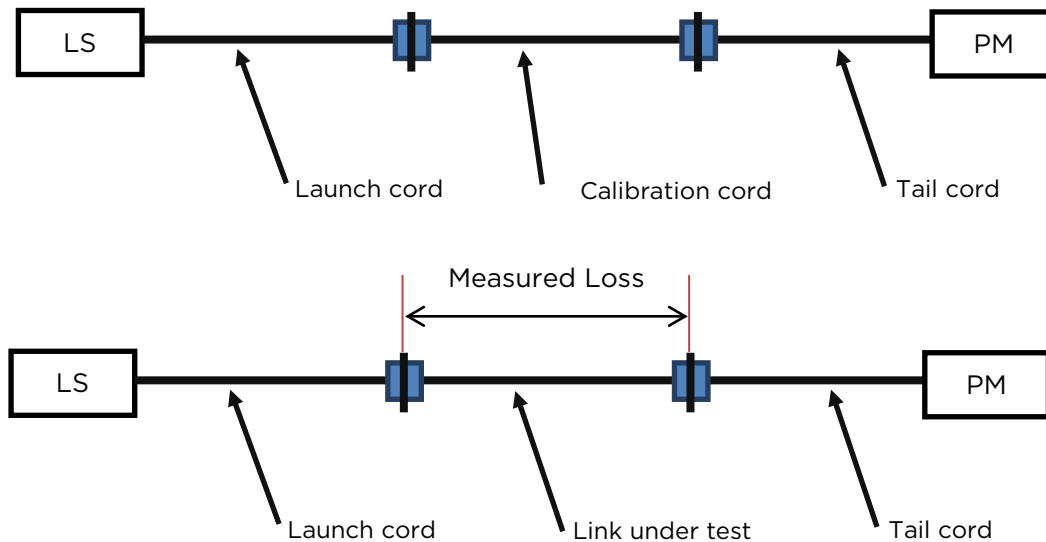

Fig. 8 Test Setup According to Reference Method with Three Test Cords

4.2 Test Setup According to Reference Method with One Test Cord

This measuring method is based on ISO/IEC 14763-3.

All connectors on the measuring equipment and within the line must be of the same type.

Calibration is performed with the launch cord used for the measurement. Subsequently, the line to be measured and a tail cord are introduced.

NOTE

The launch cord used for the field calibration must not be disconnected from the source otherwise the calibration is invalid.

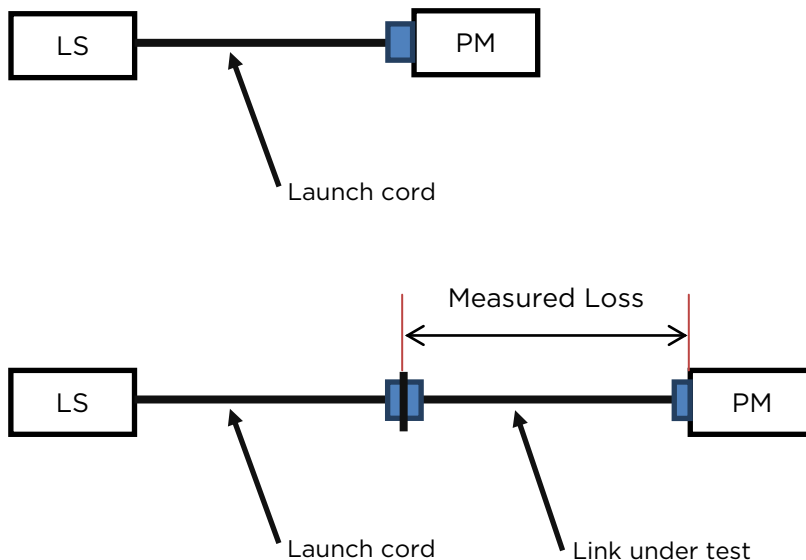

Fig. 9 Test Setup According to Reference Method with One Test Cord

4.3 Set Autotest Pref

Autotest is the test mode used most often. The Autotest allows various presettings:

- Automatic saving
- Passed/Failed Rating
 1. On start screen of Display handset (DH) select option Preferences.
 2. Select option Autotest Pref.
 3. Now enter the desired preferences in the opening screen.

NOTE

Please note that Autotest Pref entered by you must be in compliance with the requirements of the certification to be carried out.

The certification of fiber cabling is usually performed according to TIA-568 or ISO 11801 standards; in doing so, the passed/failed criterion is based on cable length, number of splices and connections in the fiber line.

In addition to these criteria, the FiberTEK™ III can also be configured for application-specific fiber tests. These fiber tests are particularly beneficial when determining whether a fiber line supports certain types of network technology, such as 100BaseSX or 1000BaseLX.

4.3.1 Selection of Fiber Test Standard

1. Use **Arrow Keys** to navigate on ready screen to "LASER" display and confirm with **Enter**.
2. Use **Arrow Keys** to select the desired fiber typeset standard and confirm with **Enter**.

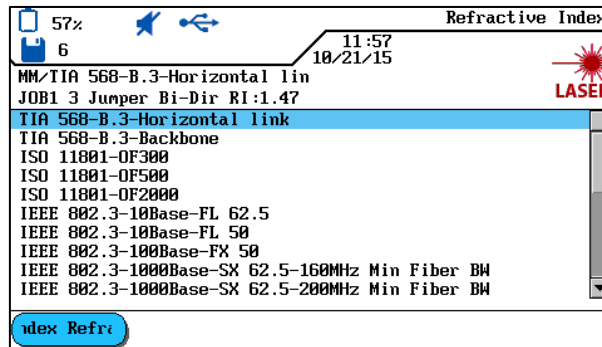

Fig. 10 Select fiber type

4.3.2 Selection of Refractive Index

1. Use **Arrow Keys** to navigate on ready screen to " LASER" display and confirm with **Enter**.
2. Use soft key **index Refr** to display the Refractive Index screen.
3. Set the Refractive Index according to the cable manufacturer's data.

Note: The Refractive Index setting is not affected by changing the Fiber Standard

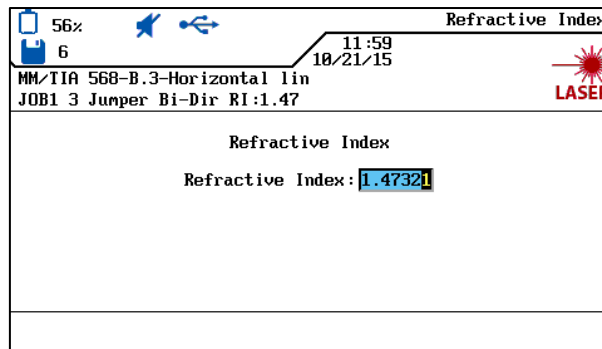

Fig. 11 Set refractive index

4.3.3 Selection of Fiber size and Wavelength

1. After selecting Fiber type, the cable properties screen is displayed.
2. Use soft key **62.5µm** to select the fiber size.
3. Use soft keys **850nm** / **1300nm** to select test wavelength

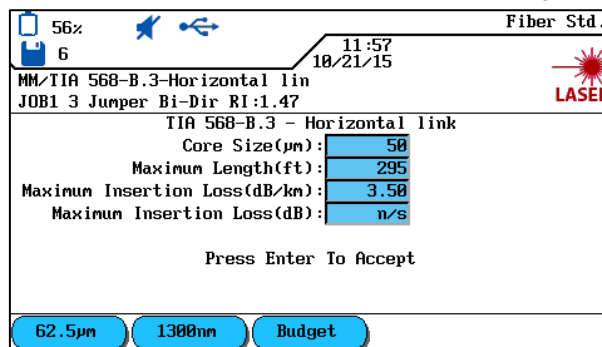

Fig. 12 Select Fiber size and wavelength



4.3.4 Determine Loss Budget

The loss budget influences the passed/failed thresholds for the loss measurements performed with FiberTEK™ III. However, since the loss budget has no impact on the actual loss measurement, this function is for informative purposes only. If the measured loss is smaller or equal to the loss budget, a ✓ is displayed. If the loss exceeds the loss budget, the following symbol appears: ✗ .

Use soft key **Budget** to open Loss Budget Menu and to change limits according to wavelength.

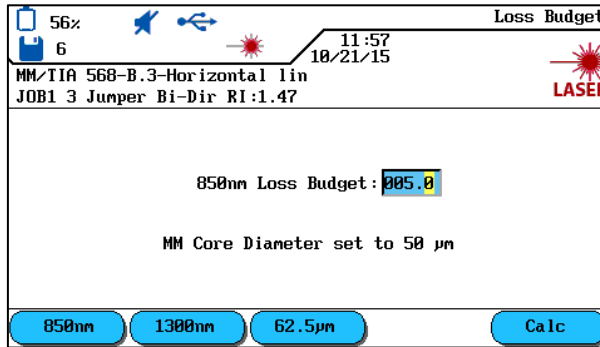

Fig. 13 Loss Budget

NOTE

Refer to Specifications to find an overview of cabling standards and application requirements for the installation of fibers.

If you want to keep the offered Budget value, confirm with **Enter**,

If not, use keypad to enter a number or use the **Calc** soft key to open input box for loss budget calculator.

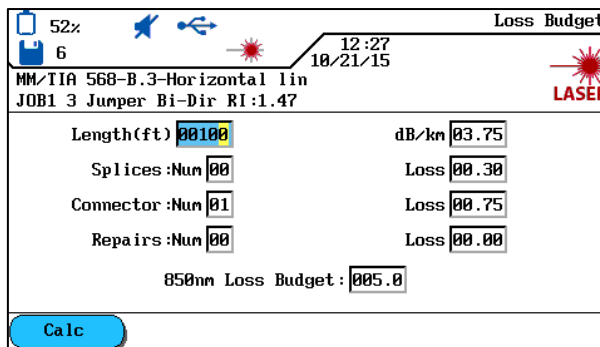



Fig. 14 Loss Budget Calculator

1. Use **Up/Down Arrow Keys** to navigate to individual boxes and use alphanumeric keys to enter details concerning the fiber line.

Length (m)	>	Loss/km
Fusion splices: Number	>	Loss
Connector Pairs: Number	>	Loss
Mechanical splices: Number	>	Loss

2. Use soft key  to calculate the budget. The result appears in Loss Budget box.
3. To confirm, press **Enter** in this box and press **Enter** in the next box.
4. Return to the Main Menu by pressing **Enter** once more.



The new limits will now be used when an Autotest is performed.

4.4 Evaluation of Autotest Results for Fibers (LWL)



4.4.1 Passed/Failed Rating

The overall Autotest result appears in the upper right of the Autotest screen. The single Autotest results appear on the right beside the corresponding tests.

Symbols for Overall Test Result



Symbol	Overall Autotest Result
	The overall Autotest was completed without errors if all single tests received a passing grade.
	The overall Autotest receives a failing grade if at least one single test failed.

Autotest Symbols for Single Tests

Symbol	Single Autotest Results
	Passed: All results are within the limits, with adequate margins.
	Implied Pass when the budget is set to zero.
	Failed: At least one result has exceeded the limit by more than the accuracy specified for the device.



4.4.2 Saving Current Autotest Results

The Autotest results can be saved in the internal memory of LanTEK®II Cable Tester immediately after the test.

- The test results are automatically saved if Autosave Pref is enabled.
- Only Autotests with the overall evaluation Passed can be automatically saved.
- Tests with fail result must be manually saved.
- A name is automatically assigned to finished tests if Auto Increment function has been enabled. Use soft key  to save the result using the default name. If another name is preferred, use option  to manually assign another name.



4.4.3 Manual Saving of Autotest Results (Autosave off)

1. To manually save an Autotest, at the bottom edge of the screen press the soft key . Now a brief acknowledgement appears, indicating the name under which the test will be saved.
2. If the current name already exists a warning message appears, asking whether you want to overwrite the existing file or enter another name.
3. Press **Escape** to cancel and return to previous display without saving or  to overwrite existing file.

4.4.4 Working with Jobs

The Autotest is saved under a unique name. The test results can be viewed, printed or deleted on the *File* screen.

1. On the ready screen, select File option and open job list.
2. Mark the desired job. Use  to open the folder containing the option list.
3. Mark the desired function and confirm with **Enter**.

4.4.5 Display of Result Details

The Autotest is saved under an unmistakable name. The test results can be viewed, printed or deleted on the *File* screen.

1. On the ready screen, select *File* option and open Job List.
2. Mark the desired job. Press **Enter** to open the job.
3. Use **Arrow Keys** to mark the desired test record.
4. Press **Enter** to open the record.
5. Press **Escape** to return to previous screen at any time.



Chapter 5. FiberTEK™ III Analyze Mode

The FiberTEK™ III selects the reference level and test limits based on the test selected. When testing fibers (LWL), the remote handset (RH) must be manually powered on.

1. Set the cable parameters including the wavelength, and perform a field Calibration if necessary.
2. On the ready screen, select *Analyze*.

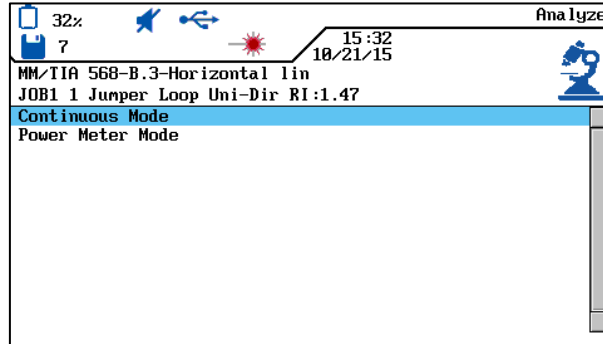

Fig. 15 Analyze

5.1.1 Continuous Run

This mode is used for troubleshooting. During continuous run, the measurement is repeated until it is manually cancelled. There is no save function.

1. In the Analyze screen select Continuous Mode.

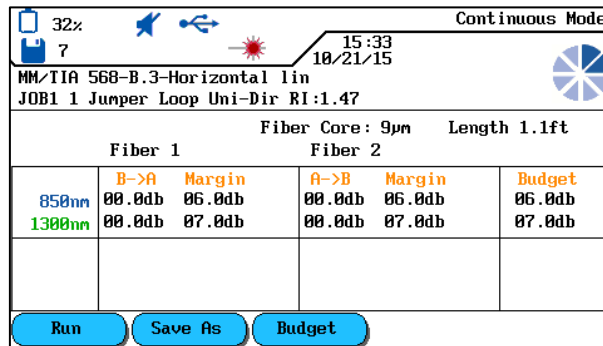

Fig. 16 Continuous Run (Ready)

2. Use soft key  to start the test

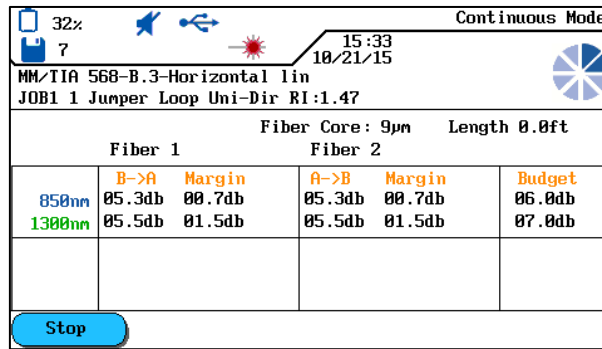

Fig. 17 Continuous Running

The FiberTEK™ III makes a measurement every few seconds. Each time a measurement is made a beep is heard and the results shown on the screen are updated. Use soft key



to stop the test. Once stopped, the result can be saved using soft key



5.1.2 Power Meter Mode

The FiberTEK™ III can be used as a power meter to measure the optical power received from a source.

1. In the Analyze screen select Power Meter.

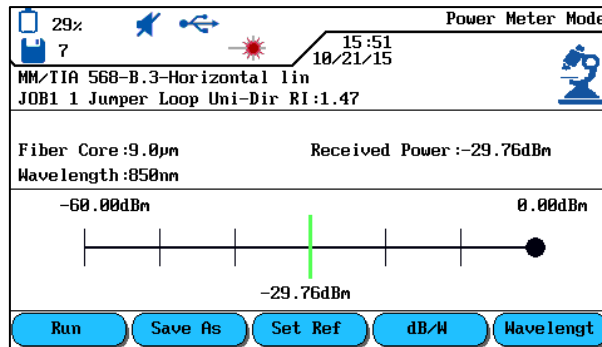





Fig. 18 Power Meter

2. Use soft key  to select the desired measurement units for optical power.
3. Use soft key  to set the calibration wavelength to match the received signal as closely as possible.
4. Use the soft key  to set the current received power level to be a reference for future power measurements. The reference level is shown by a black dot. Future power measurements are then shown in dB relative to the reference level.

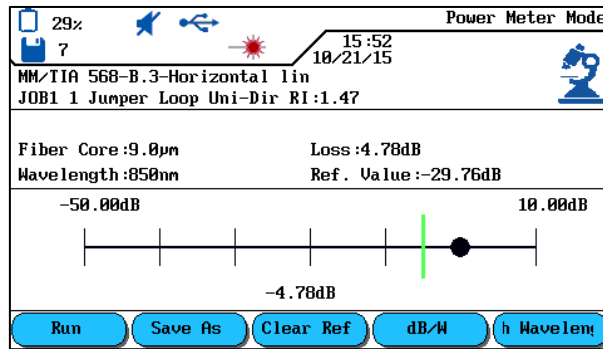

Fig. 19 Relative Power Meter

5. Use soft key **Run** to start the power meter. The display shows the received optical power numerically and graphically.
6. Use soft key **Stop** to stop the test.
7. Use soft key **Save As** to save the results.
8. Use soft key **Clear Ref** to clear the reference level and return to absolute power measurements in dBm.



IDEAL NETWORKS

IDEAL INDUSTRIES LIMITED
Stokenchurch House, Oxford Road, Stokenchurch,
High Wycombe, Bucks, HP14 3SX, UK.

www.idealnetworks.net

A subsidiary of IDEAL INDUSTRIES INC.



IDEAL INDUSTRIES, INC.