



IDEAL NETWORKS

SecuriTEST[®] IP





COPYRIGHT NOTICE

The information contained in this document is the property of IDEAL INDUSTRIES Ltd. and is supplied without liability for errors and omissions. No part of this document may be reproduced or used except as authorized by contract or other written permission from IDEAL INDUSTRIES Ltd. The copyright and all restrictions on reproduction and use apply to all media in which this information may be placed.

IDEAL INDUSTRIES Ltd. pursues a policy of continual product improvement and reserves the right to alter without notice the specification, design, price or conditions of supply of any product or service.

© IDEAL INDUSTRIES LTD. 2018

All rights reserved

Publication ref: 171810

Issue 1 - 2/18

IDEAL INDUSTRIES LTD.

Stokenchurch House
Oxford Road
Stokenchurch
High Wycombe
Buckinghamshire
HP14 3SX UK

www.idealnetworks.net



GENERAL



Introduction
Page 1



Safety
Page 2



Battery
Page 2

INTERFACE AND STATUS INDICATION



Keypad
Page 3



**Electrical
Interface**
Page 4



**Wi-Fi
Interface**
Page 5



**LED
Indicators**
Page 6



**Screen
Functions**
Page 7

SETTINGS



IP Settings
Page 8



Wi-Fi Setup
Page 9



**Shortcut
Menu**
Page 10



FTP Server
Page 11



**Storage
(SD Card)**
Page 12



HDMI OUT
Page 13



**Remote
View**
Page 14



System
Page 15

POWER



PoE Output
Page 16



DC 12v Output
Page 17



**PoE and
Power Info**
Page 18



IP CAMERA TEST



**IP Camera
Test Flow**
Page 19



Direct Camera
Page 20



**Network
Camera**
Page 21



IP Discovery
Page 20



ONVIF
Page 21



PTZ
Page 22



Chrome
Page 23



Non ONVIF Test
Page 24

HD COAX AND ANALOG CAMERA TEST



CVBS
Page 25



**PTZ Address
Scanning**
Page 27



Video Out
Page 28



TVI
Page 29



CVI
Page 30



AHD
Page 31



PTZ
Page 26

CABLE TESTING



Cable Test
Page 32

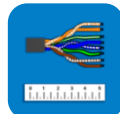

**RJ45 Cable
TDR**
Page 33



**Tone
Generator**
Page 33



IP NETWORK TEST



Ping
Page 35



IP Scan
Page 36



DHCP Server
Page 37



Available IP
Page 38



**Network
IP Scan**
Page 39



**Data Monitor
(RS485)**
Page 40

RESULTS AND TRANSFER



Test Report
Page 41



Jobs
Page 42



**File
Explorer**
Page 43



**File
Transfer**
Page 44

MY APPS



Rapid Video
Page 44



HIK
Page 46



DH
Page 47



RTSP Player
Page 48

SOFTWARE UPDATE



**Local
Update**
Page 49



TOOLS



Notepad
Page 50

TECHNICAL SPECIFICATION



Interfaces
Page 51



**Camera Test
Functions**
Page 52



**Electrical Test
Functions**
Page 53



**General Test
Functions**
Page 54



**Results,
Upgrade and
Help**
Page 55



General
Page 56



GENERAL - Introduction

SecuriTEST IP



CCTV Camera Tester for IP Digital / HD Coax / Analogue Systems

SecuriTEST IP is an installation and troubleshooting tester for digital/IP, HD coax and analogue CCTV camera systems. With a single tester that can power, configure and document, SecuriTEST IP increases productivity from start to finish.

Supply power to cameras via PoE/PoE+ (Power over Ethernet) or standard 12V DC power using its internal Li-Ion battery, eliminating the need for external power adapters and injectors.

The QuickIP™ feature allows installers who are new to IP camera systems to quickly and easily connect to cameras without being network experts.

Create professional test reports including video screen shots to verify the job has been completed successfully and reduce unpaid call backs.

Camera Configuration, Installation and Troubleshooting

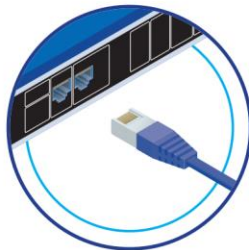

Physically connect camera

Connect camera to the tester using ports: RJ45, BNC or Wi-Fi.

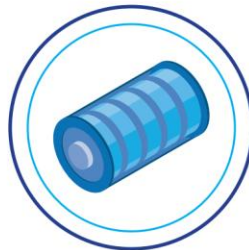

Power camera

Power the camera using: PoE (tester battery or network pass through), DC 12V/2A (tester battery).



Camera Identification and Login

Automatic network configuration and connection to IP cameras.



Send reports

Send reports from the jobsite using email or preferred file sharing website.



Document

Create reports with video images, statistics and camera settings.



Camera setup

Comprehensive setup options including aim, focus, PTZ presets, network settings (IP), video settings.



GENERAL - Safety

Exercise caution when handling rechargeable batteries.

All lithium-polymer battery packs, regardless of their indicated charge state, are capable of producing electrical current sufficient to cause personal injury and/or property damage.

GENERAL - Battery Handling

Do not dispose of battery packs in a fire or with regular waste. Battery packs may explode if exposed to open flame. The battery packs are hazardous waste and may contaminate ground water sources if disposed of in landfills.

The following battery pack handling precautions must be closely followed to avoid risk of injury.

- When a battery pack is not installed in the tester, it should be kept in a clean, dry, non-conductive package.
- Keep conductive materials away from the battery pack at all times.
- Keep contact sides of the battery pack away from each other at all times.
- Battery packs can only be charged while in the tester. Charging in any other manner may cause the battery pack to explode.
- Always install, remove, store, and charge the battery packs in a non-explosive atmosphere.
- Observe operating and storage temperatures (see Technical Specifications section).
- Do not allow children or persons unfamiliar with the precautionary instructions in this manual to handle or recharge the battery packs.
- Use only the charger supplied.

To remove the battery:

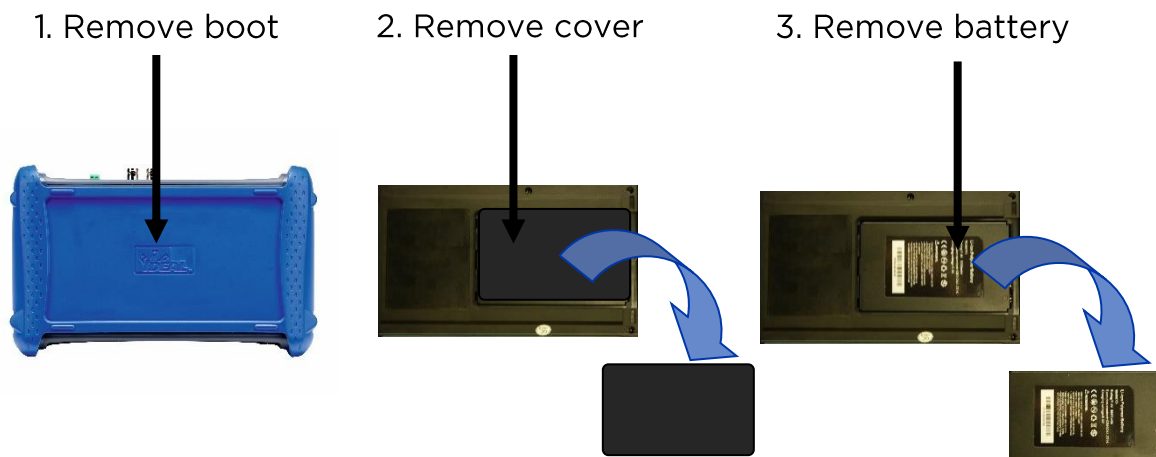

To replace the battery, reverse the above procedure.



INTERFACE AND STATUS INDICATION - Keypad



Long press to switch the tester ON/OFF.

Short press to sleep / wake

Home screen / shortcut menu

Digital zoom toggle

Focus far

Focus near

Zoom in

Zoom out

Aperture open / increase / confirm

Aperture close / decrease / exit in-camera menu

Menu navigation / PTZ controls

Confirm settings and return.

Return without confirming settings. Long press to return to home screen

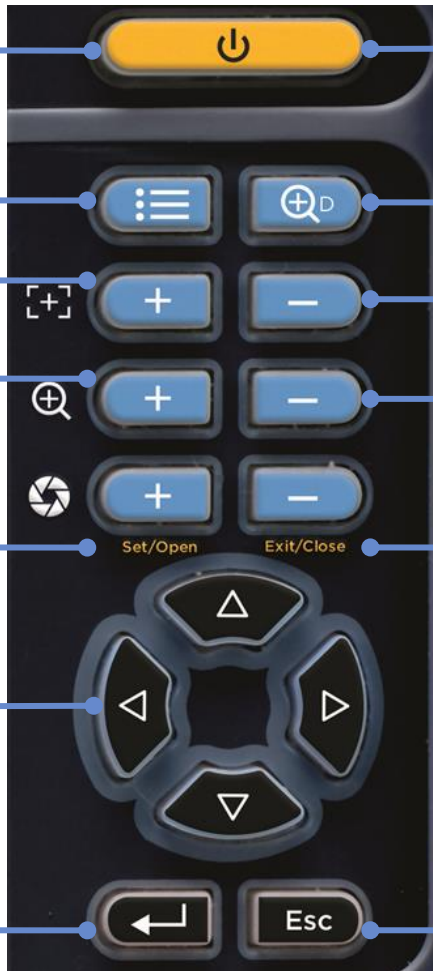

Long press to capture a screen shot.

While the screen shot is being created, a smaller version of the screen appears briefly, then the screen shot is stored in the Jobs / Screenshots folder of the internal SD card.

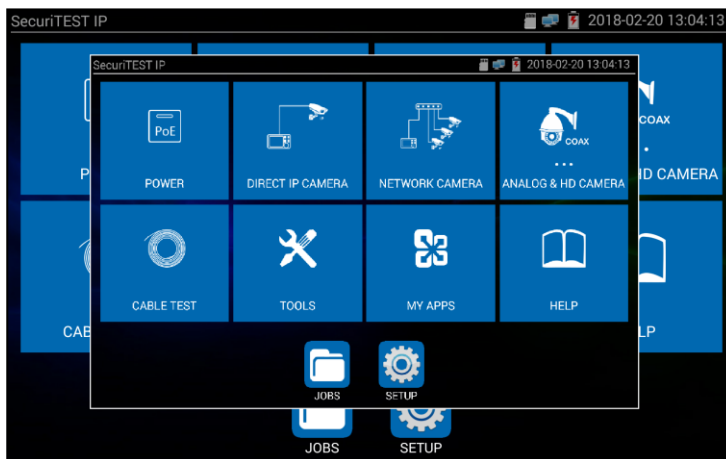



INTERFACE AND STATUS INDICATION - Electrical Interface

Top panel connectors and indicators

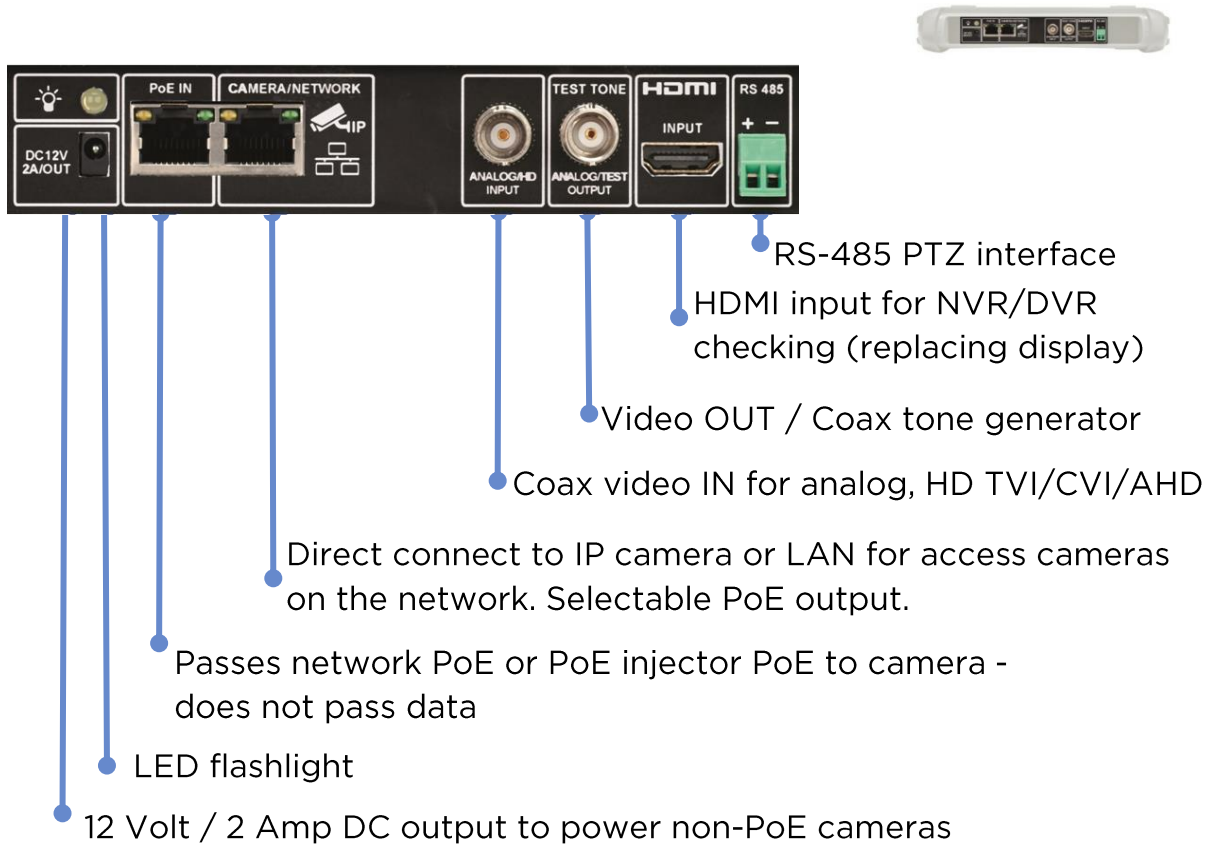

Bottom panel connectors and indicators

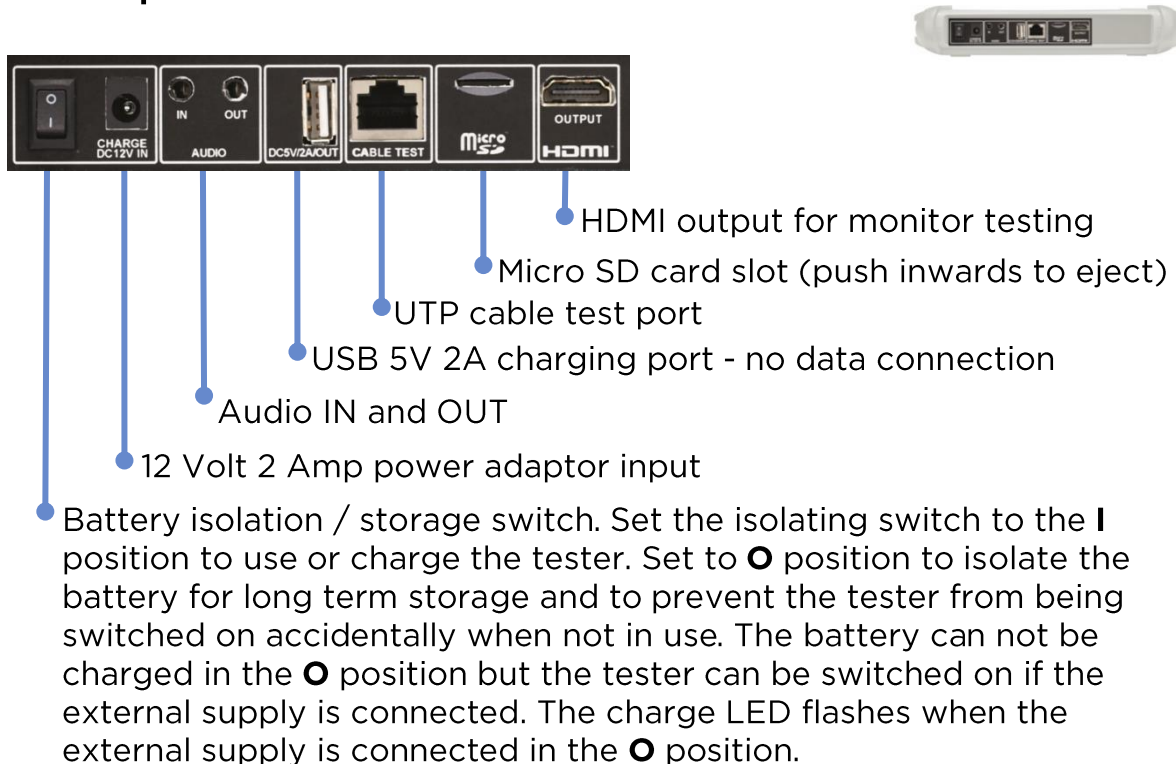



INTERFACE AND STATUS INDICATION - Wi-Fi Interface

A 2.4G 802.11n Wi-Fi port is provided inside the tester. It can be used for:

- Connecting to Wi-Fi networks to access IP cameras for testing
- Connecting to Wi-Fi networks for file transfer via Internet or FTP

When the tester is connected to a Wi-Fi network, the Wi-Fi icon  is displayed on top right hand corner of the screen.

SETUP >> Wi-Fi

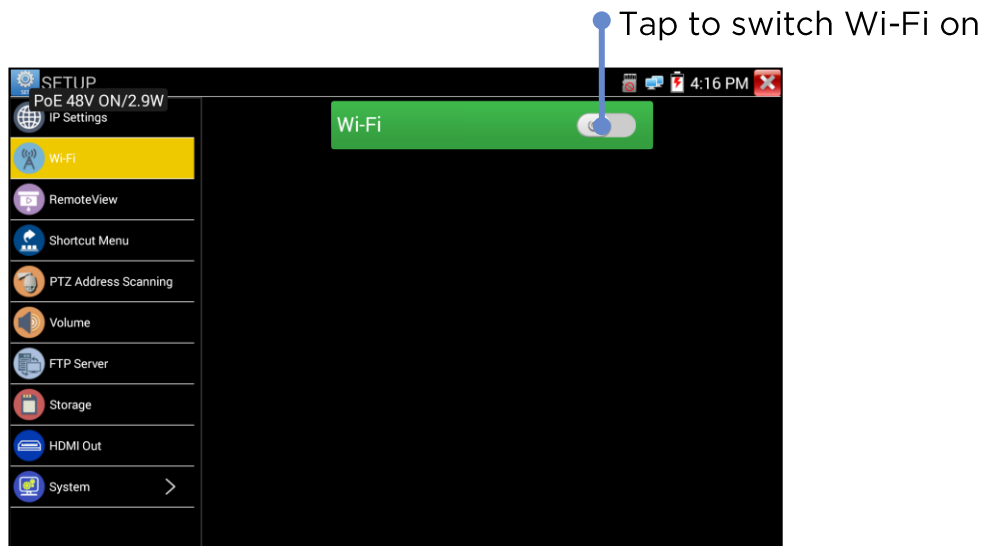



INTERFACE AND STATUS INDICATION - LED Indicators

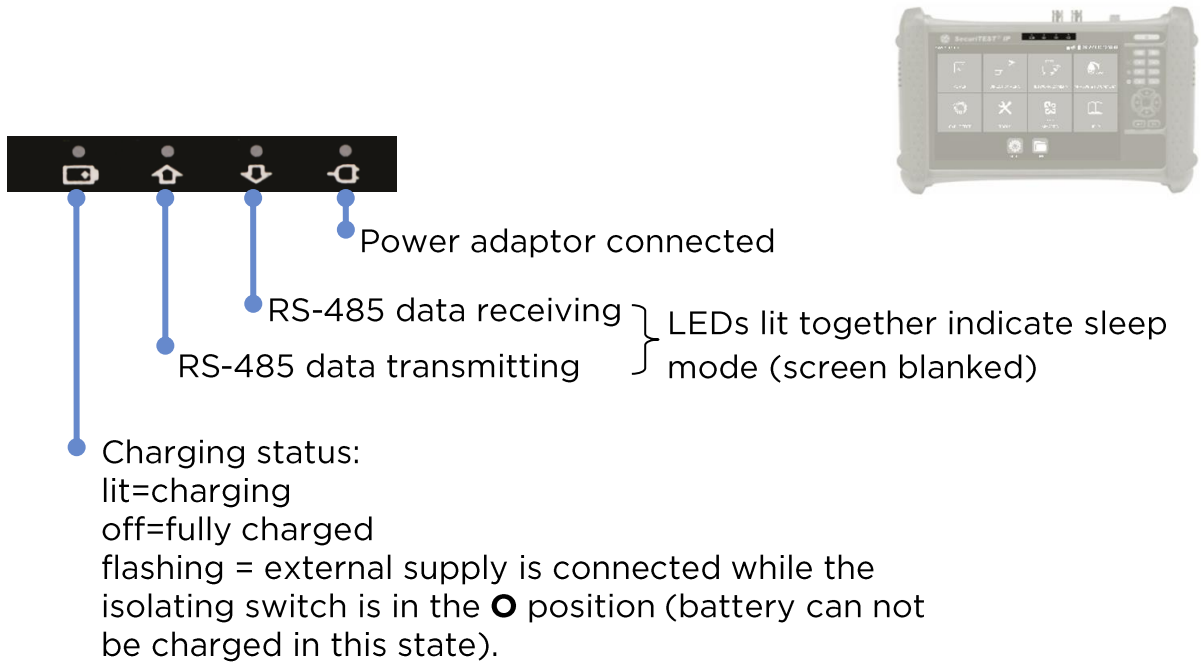

The charging status is also indicated by the  icon at the top right of the screen



INTERFACE AND STATUS INDICATION - Screen Functions

Status indications

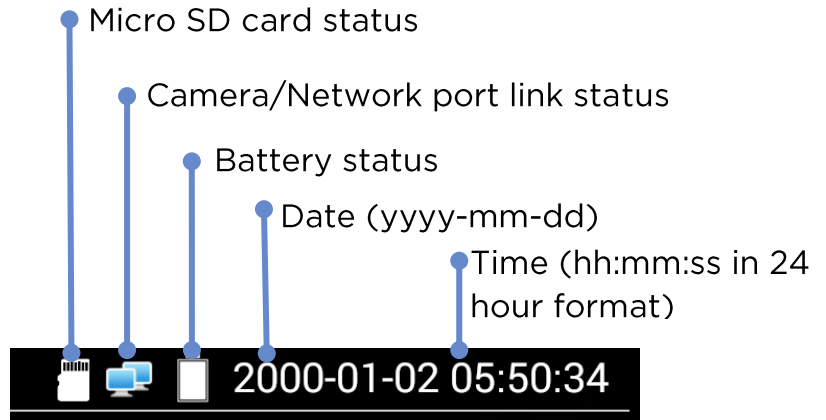
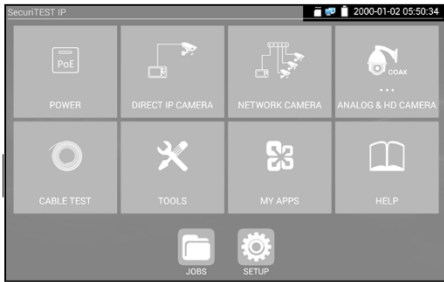

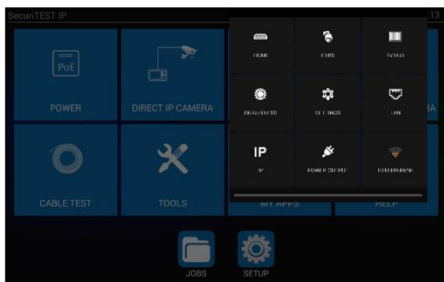

Quick Access Menu

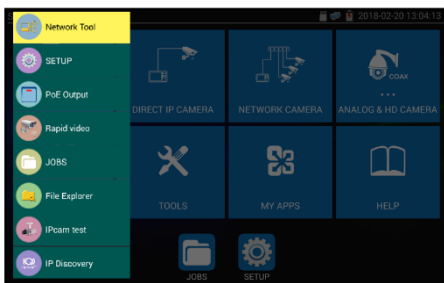

Drag down from the top right hand corner of the screen to reveal the Quick Access Menu. This provides quick access to a selection of commonly used tester functions. (Note that this selection is not user-configurable.)

Shortcut Menu



Press the  key to reveal the Shortcut Menu. This provides shortcuts to up to 8 tester functions, configurable under SETUP >> Shortcut Menu.

Icon re-arrangement

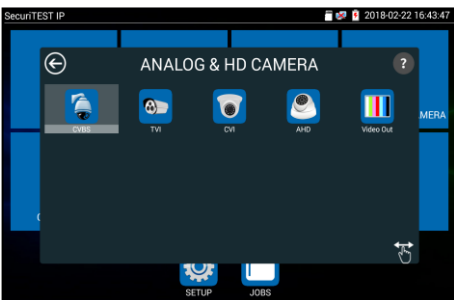

Tap any of the Main Menu icons to display the relevant menu. Touch and hold any menu icon to drag it into a new position in the same menu.

Tap the  icon to turn it orange. Then touch and hold any menu icon to drag it and release in the desired different menu folder.

(Note that a Factory Reset will restore all icons to their standard positions, but any software update performed since the tester was manufactured will need to be re-installed following Factory Reset.)



SETTINGS - IP Settings

SETUP>>IP Settings

Tick RJ45 to enable the LAN socket and switch off Wi-Fi

Tap to configure the DHCP server

DHCP server status on/off

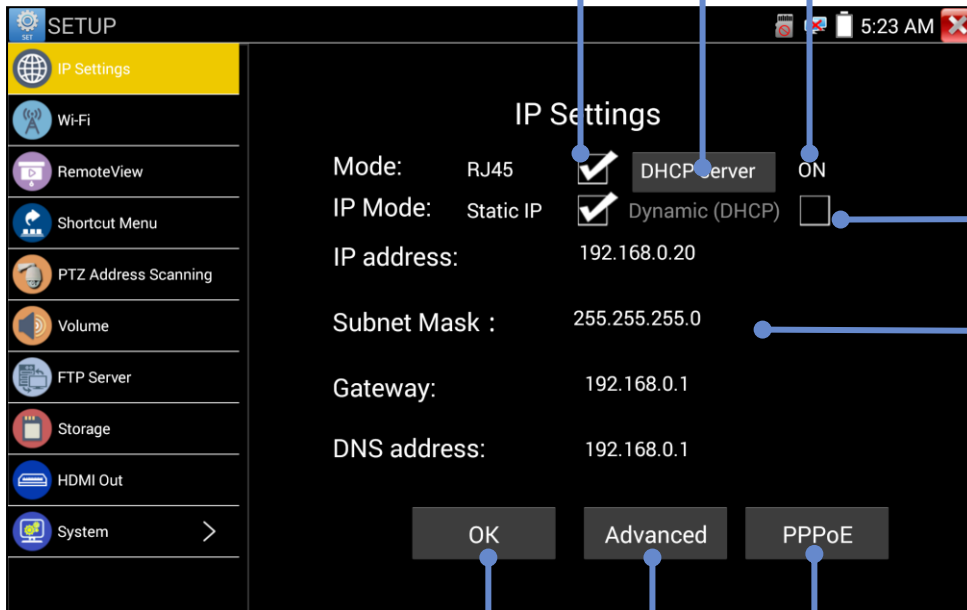

Select Static IP or Dynamic IP (DHCP)

Edit static addresses or display network-assigned Dynamic IP addresses

PPPoE is used for authentication of the network access with known user name and password.

Enables preset IP addresses to be entered for future use.

OK applies the new settings only if they are valid



SETTINGS - Wi-Fi Setup

SETUP>>Wi-Fi

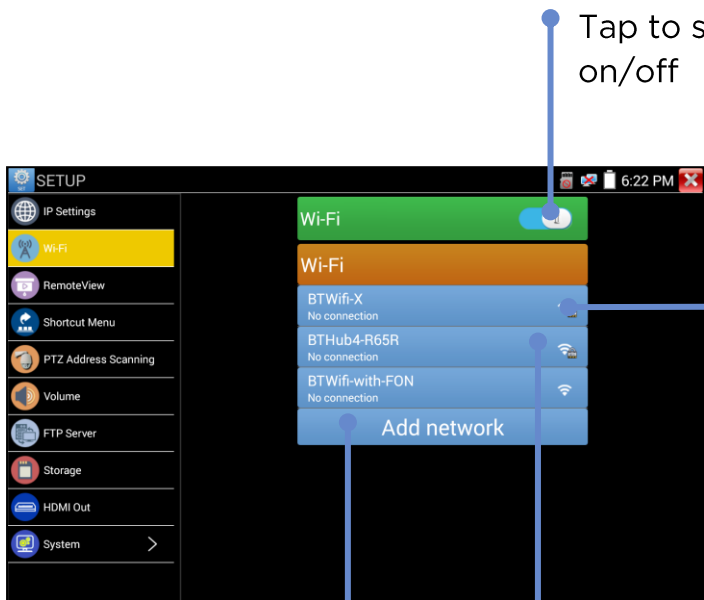

Tap to switch Wi-Fi on/off

Tap a connected network to display its details and to remove it from the list:

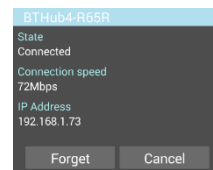

Touch and hold to enter the IP address details of the Wi-Fi router:

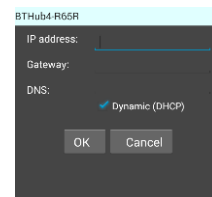

Tap an available network to enter its password and to connect to it:



Tap to enter network details manually:

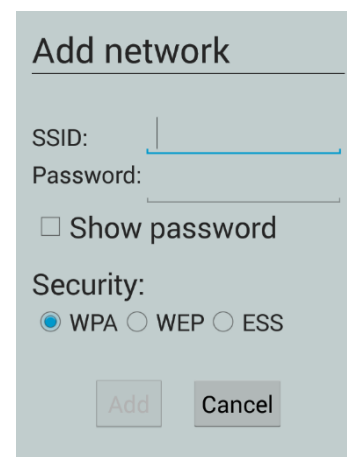



SETTINGS - Shortcut Menu

SETUP>>Shortcut menu

Touch and hold an application icon to move it automatically to the Shortcut menu. (Up to 8 icons can be moved to the Shortcut Menu)

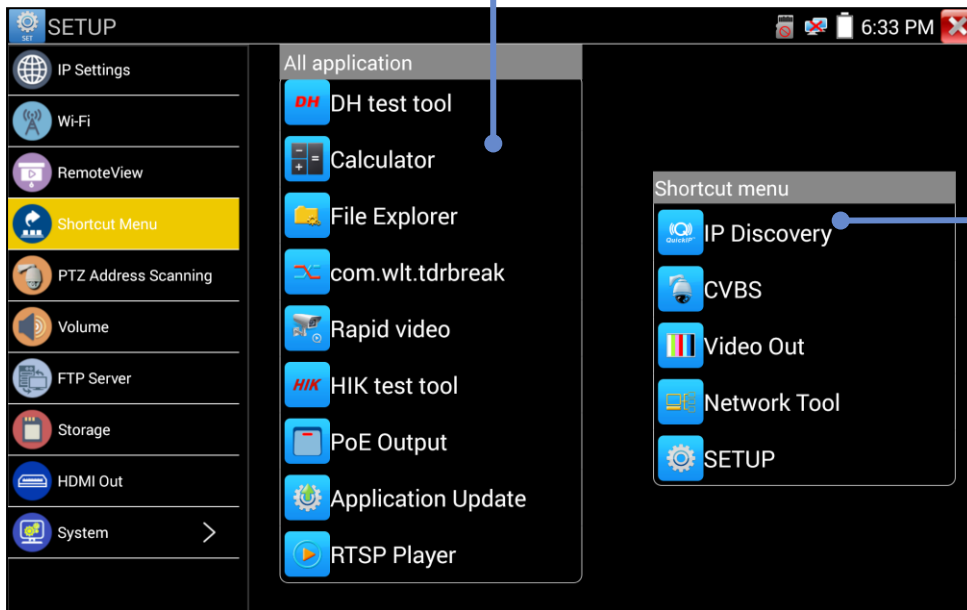

Touch and hold an application to move it back automatically to the main applications list

Press the  key to reveal the Shortcut Menu or to return from the open App.



SETTINGS - FTP Server

The FTP server can be used to transfer files to and from the tester via network interface.

SETUP>>FTP Server

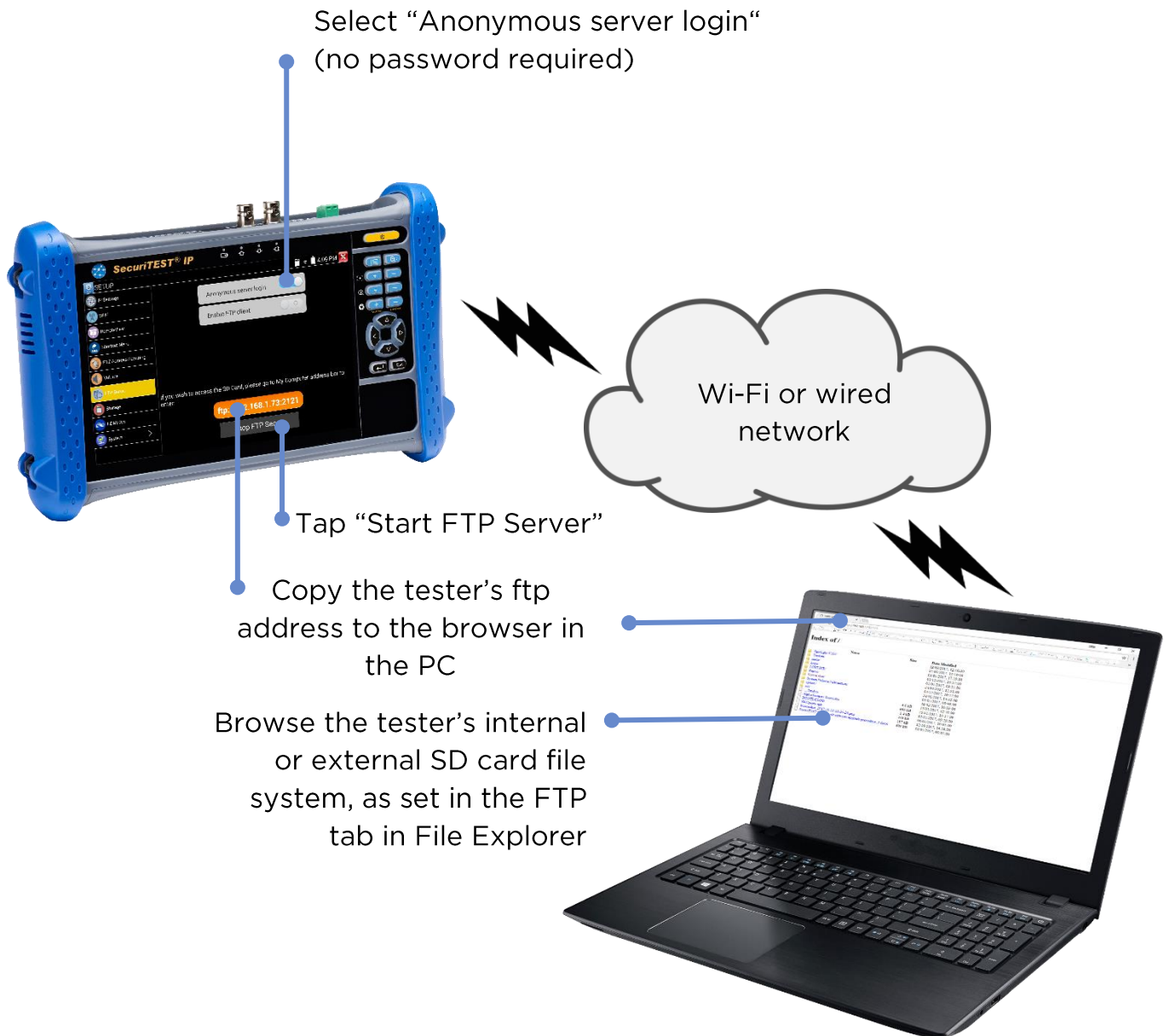



SETTINGS - Storage (SD Card)

SETUP>>Storage

• Displays the Total, Used and Available capacity of the internal storage

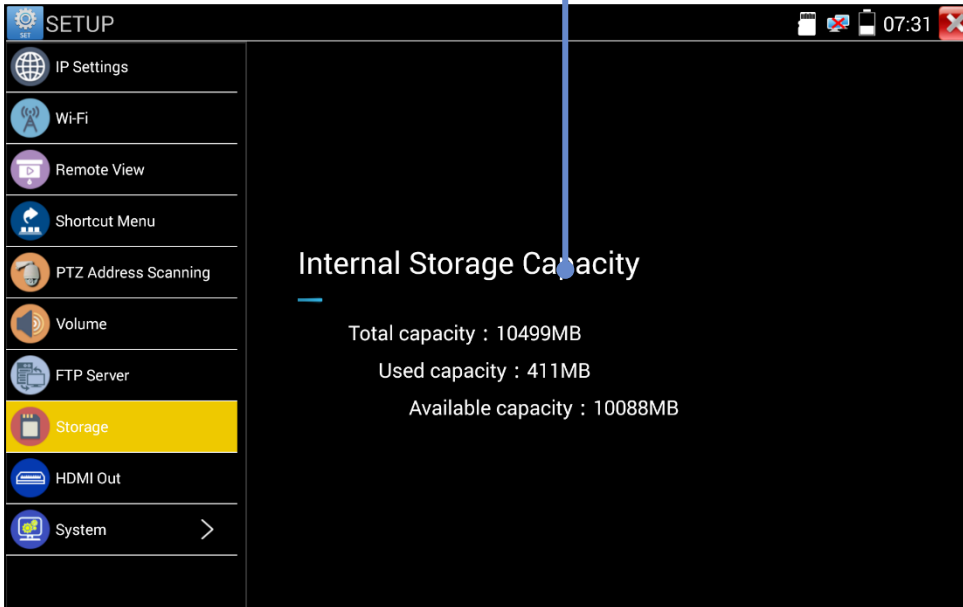



SETTINGS - HDMI Out

SETUP>>HDMI Out

Used for testing monitors and projectors and for training. The tester's screen (static or video) is mirrored to the HDMI Output port.



Tap to switch the HDMI output on/off (default is ON)

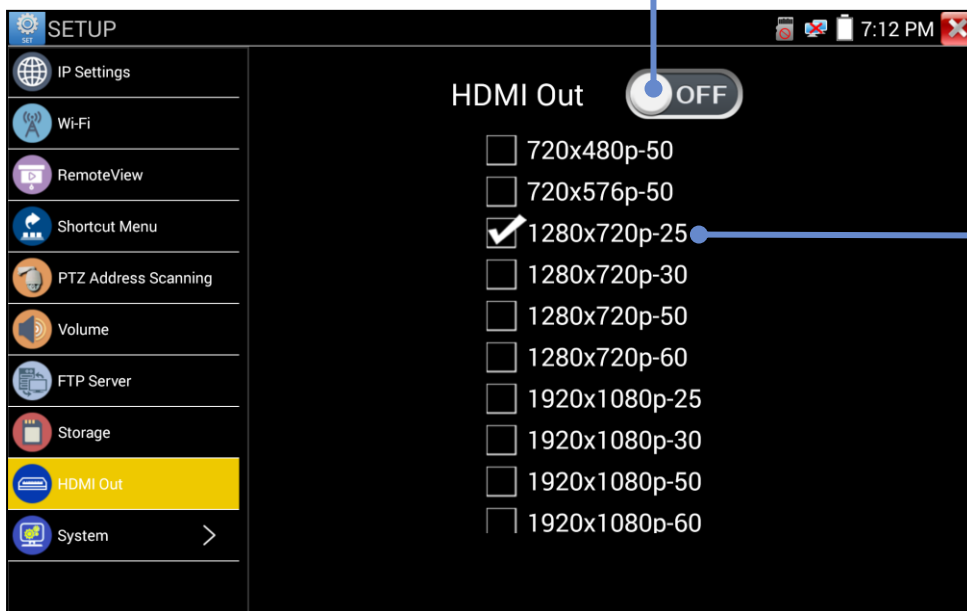

Select the required HDMI resolution / format



SETTINGS - Remote View

SETUP>>Remote View

Use Remote View to stream video from the tester's screen to the LAN / Wi-Fi port. Use an RTSP player (VLC recommended) to view the video on a PC or smart device connected to the tester via a network.

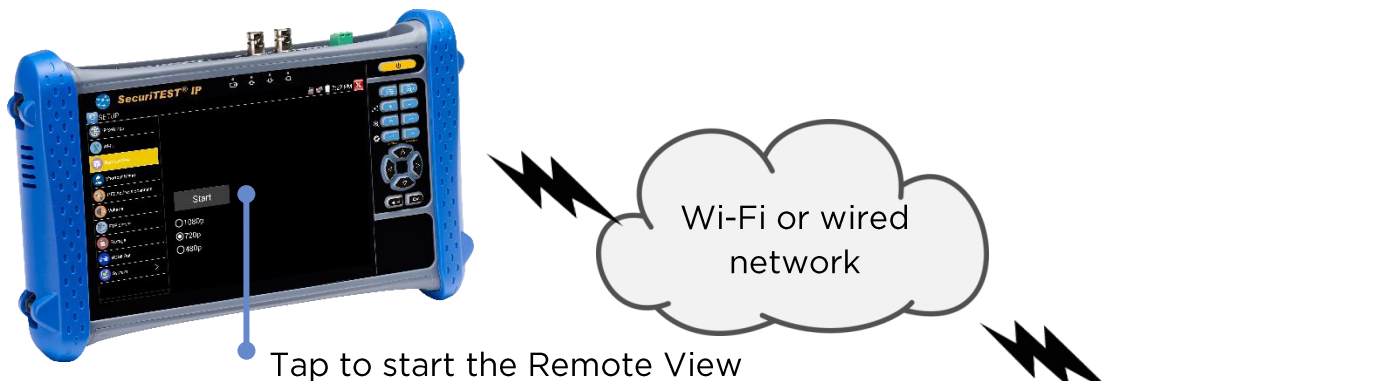

Copy the URL from the tester screen to the VLC settings (Network >> Address) in the PC (or capture the QR code on a smart device)

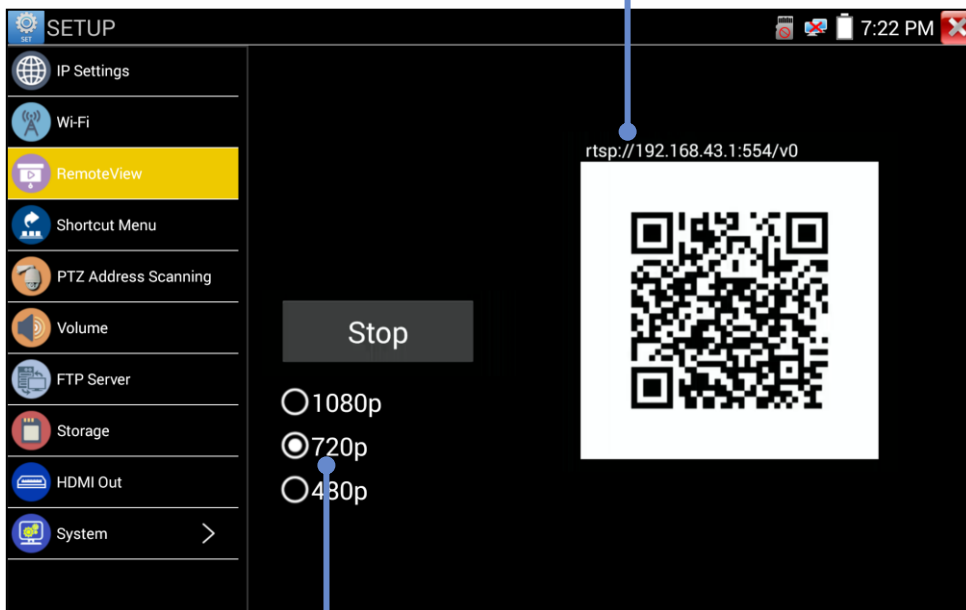



Select the required Remote View resolution / format



SETTINGS - System

The System settings are grouped under the heading of System.

Tap  to expand the System group.

Tap  to return to the top level Setup menu

SETUP>>System>>Date & Time

Tick to synchronise with local time

Tap to select local time zone

Set Date and Time (when Auto is un-ticked)

Tap to apply the new settings (when Auto is un-ticked)

SETUP>>System>>Factory Reset

Tap 

then confirm to restore the tester configuration to the original factory settings.

CAUTION! Any software updates performed since the tester was manufactured will need to be re-installed following Factory Reset. (Note that the user software can not be backed up. For standard software, the user needs to download latest SW from IDEAL Networks web site to recover it. The user’s own software needs to be reinstalled separately.



POWER - PoE Output



The tester's LAN port is equipped with Power over Ethernet capability. It can be used to provide power to PoE enabled cameras:



POWER >> PoE

- Tap the switch to turn PoE on/off
 - Floating indicator shows PoE status, voltage and power consumed. This floating PoE indicator can be dragged to any convenient place on the screen, and always appears on top.
- Double-tap the floating indicator to display / hide more details:

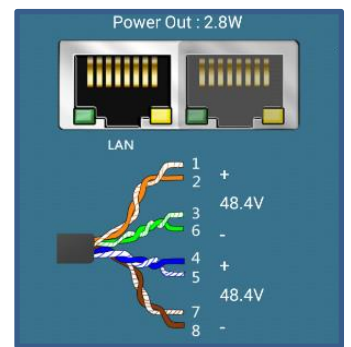

PoE Output

PoE 48V ON/2.2W

PoE

LAN

1 + 49.3 V
2 -
3 + 49.3 V
4 -
5 +
6 -
7 +
8 -

PoE power output : ON

Power2.2W

Indicates that PoE is present on the LAN/Network port

Indicates the pin numbers of the actual PoE voltages applied

Indicates the PoE power consumed by the load



POWER - DC 12V Output

The 12 volt DC socket on the top panel of the tester can supply up to 2 amps to non-PoE cameras.



Note that the power is always present on the socket, regardless of the setting of the PoE switch.

TOOLS >> PoE & Power Info

	PSE/PoE Input	12V Input	12V Output																								
Voltage	<table border="1"> <tr><td>1</td><td>+</td><td>+</td></tr> <tr><td>2</td><td>48.7 V</td><td>48.7 V</td></tr> <tr><td>3</td><td>-</td><td>-</td></tr> <tr><td>4</td><td>+</td><td>+</td></tr> <tr><td>5</td><td>48.7 V</td><td>0.0 V</td></tr> <tr><td>6</td><td>-</td><td>-</td></tr> <tr><td>7</td><td>+</td><td>+</td></tr> <tr><td>8</td><td>-</td><td>-</td></tr> </table>	1	+	+	2	48.7 V	48.7 V	3	-	-	4	+	+	5	48.7 V	0.0 V	6	-	-	7	+	+	8	-	-		
1	+	+																									
2	48.7 V	48.7 V																									
3	-	-																									
4	+	+																									
5	48.7 V	0.0 V																									
6	-	-																									
7	+	+																									
8	-	-																									
Power	2.7W	12.8W	2.1W																								

Indicates the output voltage

Indicates the output power



POWER - PoE and Power Info

TOOLS >> PoE & Power Info

(Note - when this screen is displayed, the PoE output is switched off if the tester is running on battery power. At the same time the PoE Input power and data will be passing through to the LAN/Network port.)

Indicates PoE input status

Use the 12 v input for testing camera power supplies

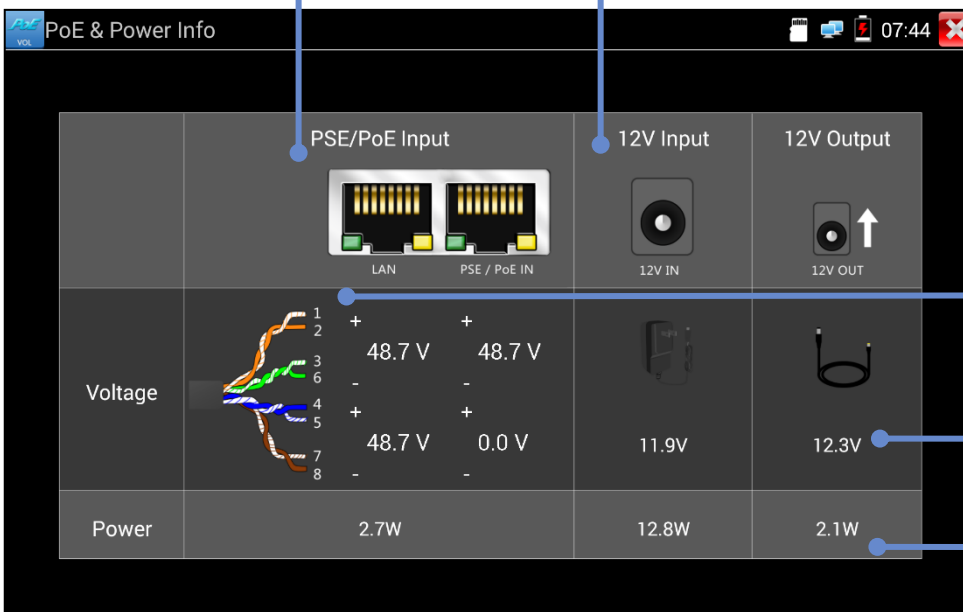

Indicates the pin numbers of the PoE input voltages. The PSE voltage will pass through to LAN/Network port while data will not pass through.

Indicates the PoE / DC voltages present

Indicates the power consumed by the load or provided by the camera or PoE supply



IP CAMERA TEST - IP Camera Test Flow

A typical test sequence consists of providing power to the camera, connecting to it and accessing its controls, setting it up and creating a report to record its correct operation:

1. POWER

Provide power to the camera and allow time to boot up.



2. IP SET

Use IP Discovery to find the IP address of a single camera or use NETWORK CAMERA or ONVIF to find the IP address of a network connected camera.



3. ACCESS

User name or password may be needed to access the camera.



4. SETUP

Setup camera parameters such as name, IP address, video format etc via ONVIF and web browser.



5. DOCUMENT

Create test reports for ONVIF IP cameras and screen shots for Analog & HD coax cameras.





IP CAMERA TEST - IP Discovery / DIRECT IP CAMERA

Quick IP Device Discovery



The IP Discovery tool provides facilities for discovering and testing a single directly connected IP camera.

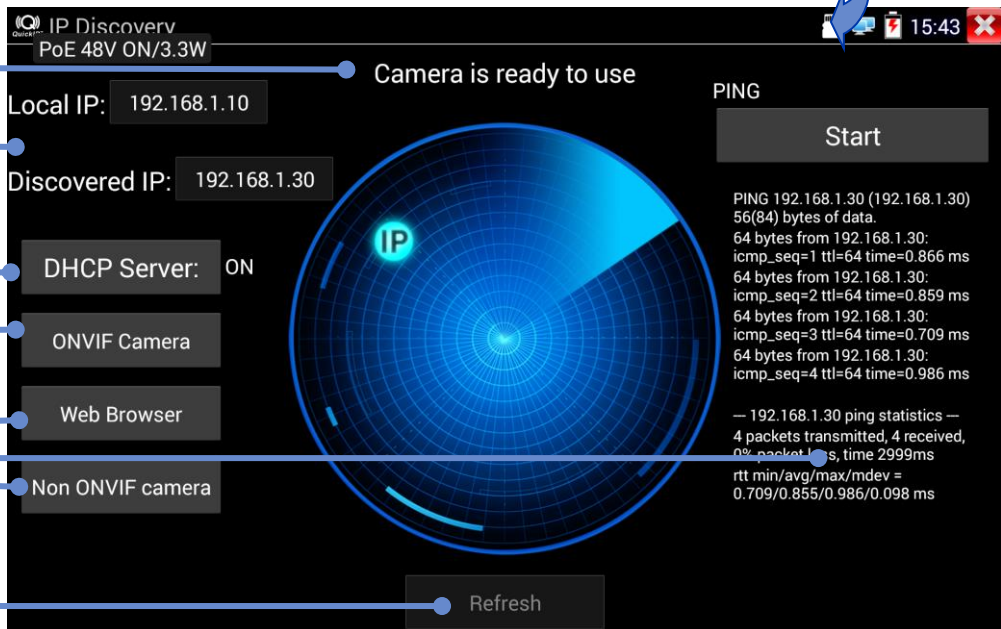
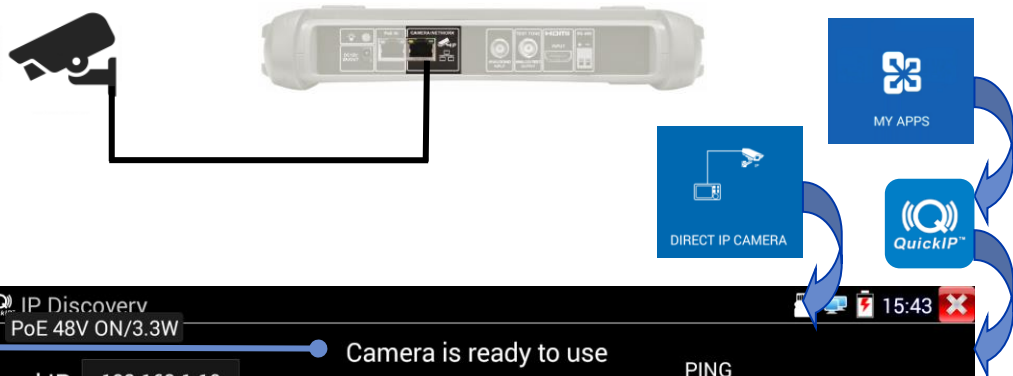

- Touch **REFRESH** to start the IP Discovery again following a timeout.
- Touch **NON-ONVIF CAMERA** to access the Non-ONVIF test function.
- Displays the results of the PING test. Touch **start** to PING the detected camera to verify network connection.
- Touch **WEB BROWSER** to access the camera via Chrome
- Touch **ONVIF CAMERA** to connect to ONVIF-compliant cameras.
- Controls and indicates DHCP status
- Displays the IP address of the tester and the discovered IP address of the connected camera. The tester sets its IP address in the same sub-net as the camera.
- Displays the status of the discovered camera



IP CAMERA TEST - ONVIF / NETWORK CAMERA

ONVIF Camera Test

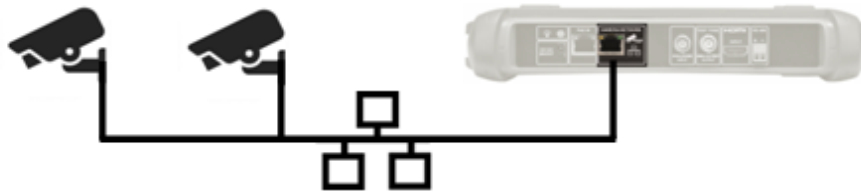

Cameras that are compliant with the standard methods of communication established by the Open Network Video Interface Forum (ONVIF) can be connected and tested without the need to make any manual adjustments to the connection details regardless of camera brand. (Note that some cameras may be only partially ONVIF compliant)

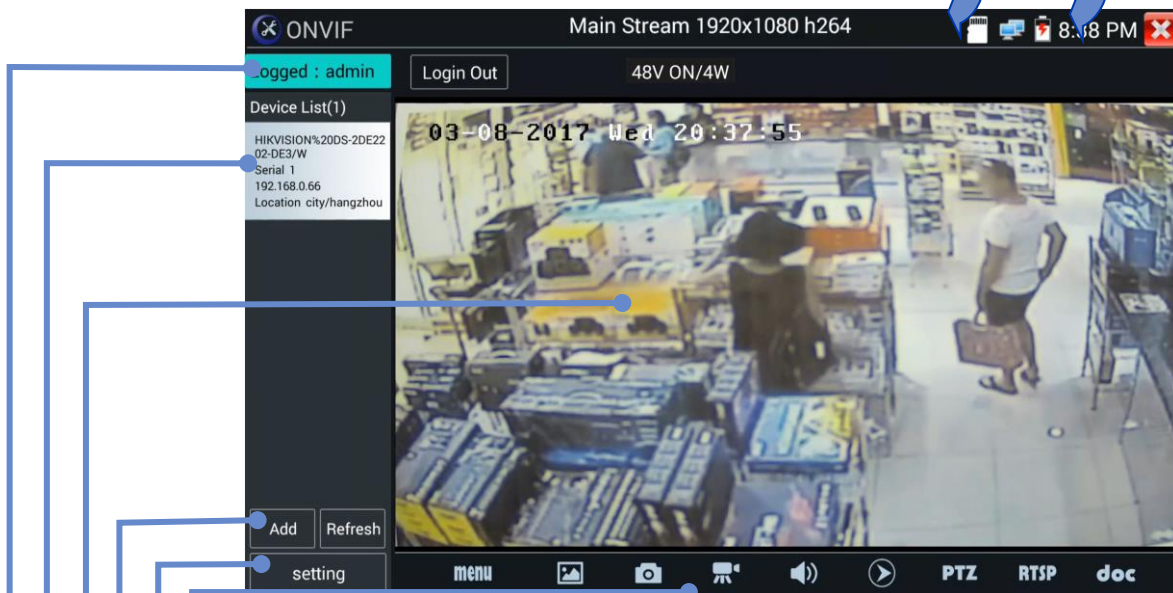
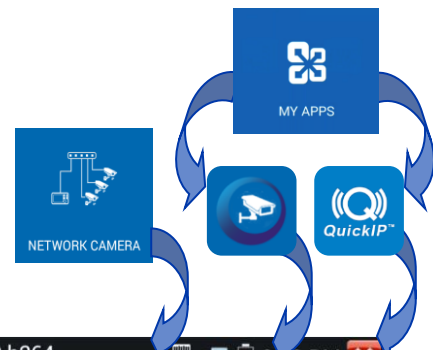

- Touch an icon to display the camera setup menu, capture and play photos and videos, Pan/Tilt/Zoom ([see PTZ section](#)), RTSP address, preview and create test reports ([see Test Report section](#)). Touch and drag tool bar to display the "?" icon.
- Touch **setting** to adjust the ONVIF settings
- Touch **Add** to add a new camera using its URL. Touch **Refresh** to update the Device List
- Displays the video stream from the connected camera. Double-tap to switch full-screen display on/off.
- Displays a list of available cameras. Touch a camera to connect to it.
- Displays the user name of the connected camera when logged in. When logged out, allows user name and password to be entered.



ONVIF CAMERA TEST - PTZ



The Pan/Tilt/Zoom (PTZ) functions of IP cameras can be tested using the [keypad arrow buttons](#) or screen gestures or by using user-defined presets of the angle, distance and objective as well as speed for the PTZ.

PTZ presets can be programmed into the camera and tested using this software tool.

The other parameters of the IP camera can be configured via ONVIF menu or WEB BROWSER.

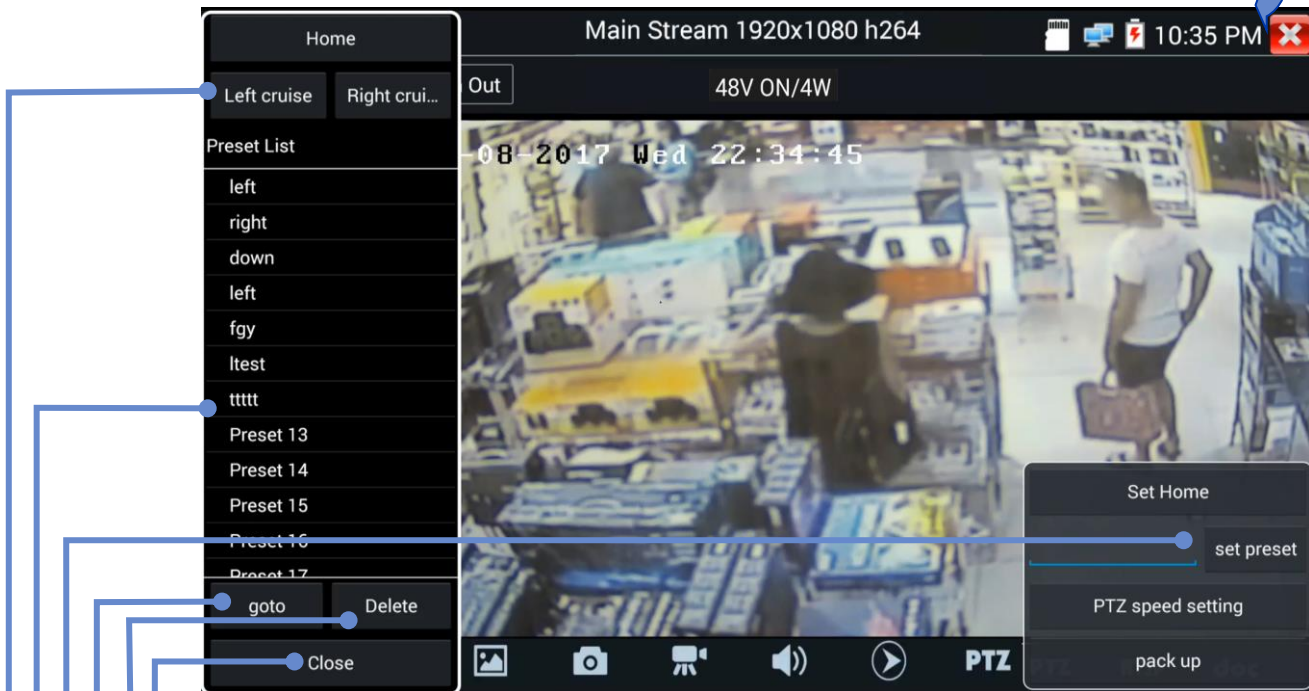
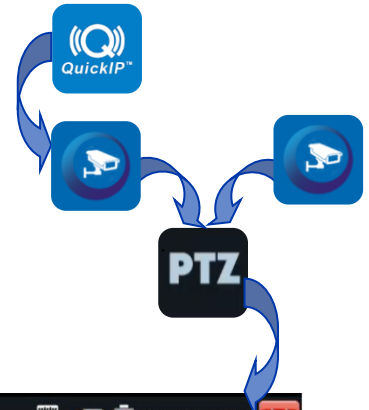

- Touch **Close** to return to the ONVIF screen.
- Touch **Delete** to remove the highlighted preset from the list
- Highlight a preset then touch **goto** to instruct the camera to go to the specified PTZ settings
- Create a new preset by moving the camera to the desired position then touch **set preset** to add it to the list
- Displays a list of PTZ settings previously set by the user.
- Touch **Left cruise** or **Right cruise** to test the 360o left/right slow pan.



IP CAMERA TEST - Chrome



The Chrome web browser provides an interface for connecting to the web servers in connected cameras. This allows setting of the cameras through their web interface.

Note: Many cameras require the Microsoft ActiveX plug-in to display live video in a web browser. ActiveX is not supported by the Android operating system.

Some non-ONVIF compliant cameras will display live video using alternative video compression protocols.

Some of the cameras do not support all functions on Chrome browser. Please be aware of this.

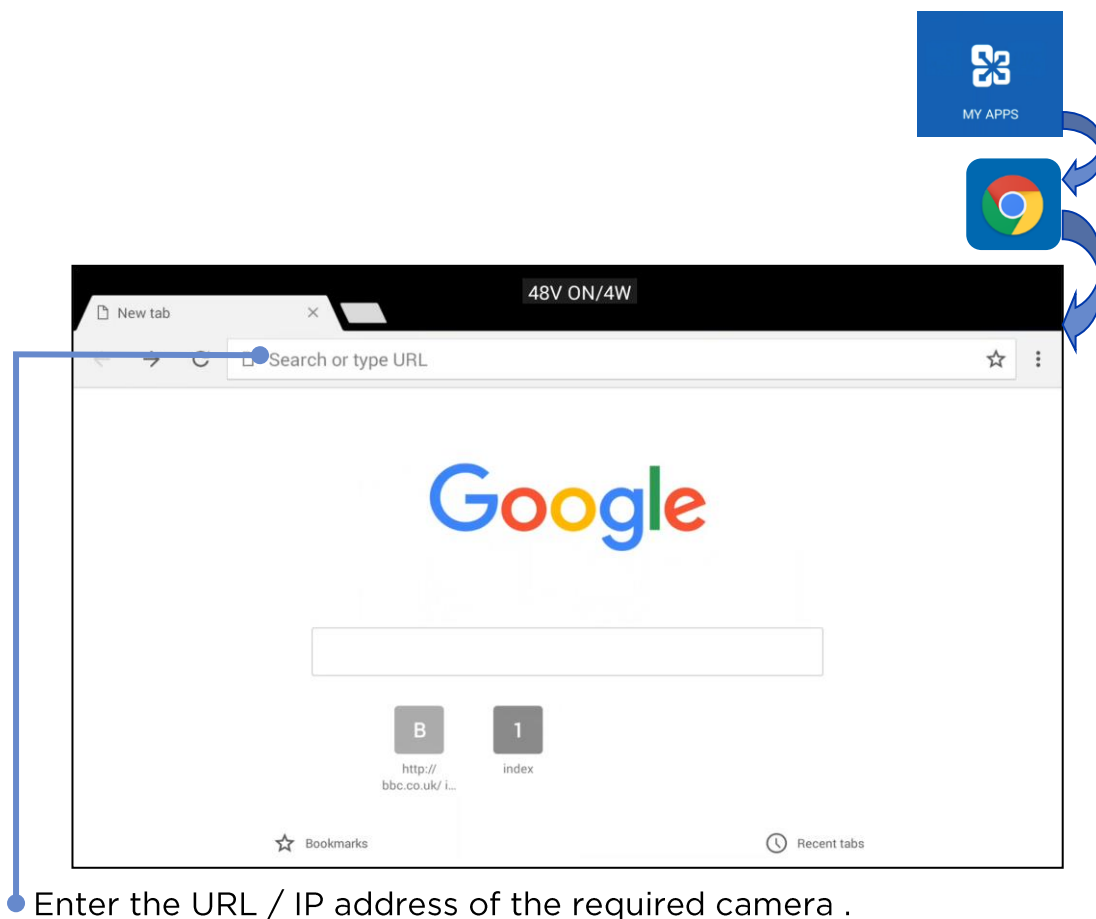

Press  to close the browser



IP CAMERA TEST - Non ONVIF IP Camera Test

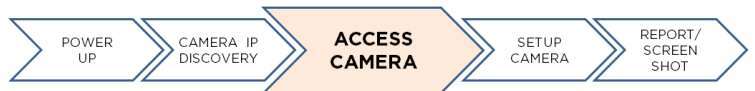

The Non ONVIF (IPCam) test screen provides facilities for discovering, viewing and testing connected non-ONVIF compliant cameras using their IP address.

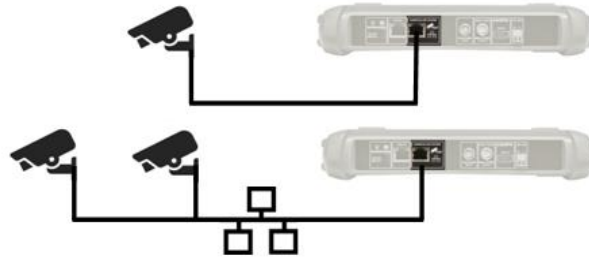

- RTSP stream subject availability of camera under test.
- Touch Reset to cancel all settings. Touch Restore to go back to the previous settings.
- Touch Enter to connect to the specified camera
- Enter the TCP / UDP port number for the required camera
- Show password
- Enter the user name and password of the camera
- Search camera IP address
- Select camera brand and model or select Auto to search automatically
- Touch Edit to go to the IP settings screen to set the IP address and Subnet Mask of the tester, and the address of the gateway and DNS.



ANALOG CAMERA TEST - CVBS

Cameras using the Composite Video Blanking and Sync (CVBS) analog standard can be tested



- Settings for Photo or Video file naming. Auto creates a file name automatically. Manual allows user to set file name. (Only numeric values are allowed for the filename)

- Touch +/- or drag the sliders to adjust the picture settings

- Displays the video stream from the connected camera

- Touch to display the Video Levels on the bottom left corner. Displays the levels of the different components of the Composite Video stream from the connected camera.

Video level

Peak level : 0

Sync level : 0

Burst level : 0



ANALOG CAMERA TEST - PTZ

The Pan / Tilt / Zoom of Analog cameras can be controlled by the keypad or by screen gestures.



Tap  to display the PTZ control screen (may vary depending on the type of camera):



To set each parameter, tap it and select from the displayed list or enter the required number:

- Protocol - Must match the camera setting
- Coaxitron - Choose PTZ (controlled by keypad) or Menu (controlled by on-screen controls)
- Port Type - Must match the camera setting
- Baud Rate - Must match the camera setting
- Address - Must match the camera setting
- Pan Speed - Enter the required speed (0-63)
- Tilt Speed - Enter the required speed (0-63)
- Set Preset Position - Save the current PTZ setting and give it a number
- Recall Position - Recall - Go to a previously saved PTZ position

Use screen gestures to control PTZ:



Slide left / right to control Pan and up / down to control Tilt





Pinch to Zoom out.



Spread to Zoom in.



Use the keypad  to control PTZ ([see Keypad section](#)). Press  to switch Digital Zoom on. A thumbnail of the zoomed view is displayed at the bottom left of the screen. Use the zoom and pan keys to adjust the zoomed view.



ANALOG CAMERA TEST - PTZ Address Scanning

When enabled, Securitest IP will scan PTZ addresses in the analog video modes. Scanning will stop when exiting analog video mode. Used for connecting a single camera only. If connected to a head-end, multiple cameras will be activated during the scanning process.

Note that the PTZ parameters must first be set to match the camera ([see PTZ section](#)).

SETUP >> PTZ Address Scanning >> ON
then ANALOG & HD CAMERA>>CVBS>>PTZ

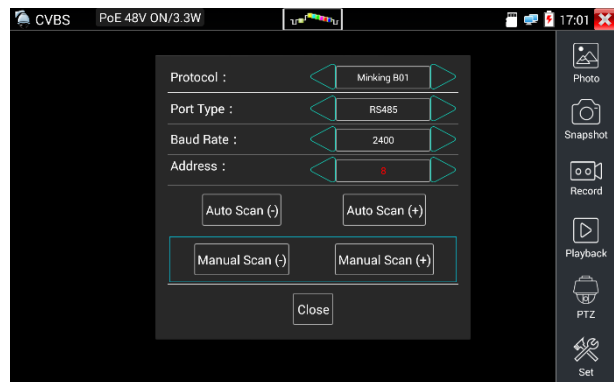

Set protocol, communication port, communication rate, to match the PTZ camera under test, then to press "Scanning" to start the PTZ camera's address searching.

Touch "Auto scan +". The address increments in steps of 1. When the address is found, the PTZ camera will continue to pan right. Touch "Auto scan(+)" to stop address incrementing. Then use "Manual scan (-)" to search the address until the camera stops panning right. At this point, the address field shows the camera's PTZ address.

Touch "Auto scan -". The address decrements in steps of 1. When the address is found, the PTZ camera will continue to pan left. Touch "Auto scan(+)" to stop address decrementing. Then use "Manual scan (-)" to search the address until the camera stops panning left. At this point, the address field shows the camera's PTZ address.



ANALOG CAMERA TEST - Video Out

The Video Out function generates and displays a test pattern which can be used to test TV monitors and cabling infrastructure via Analog/Test Output interface.

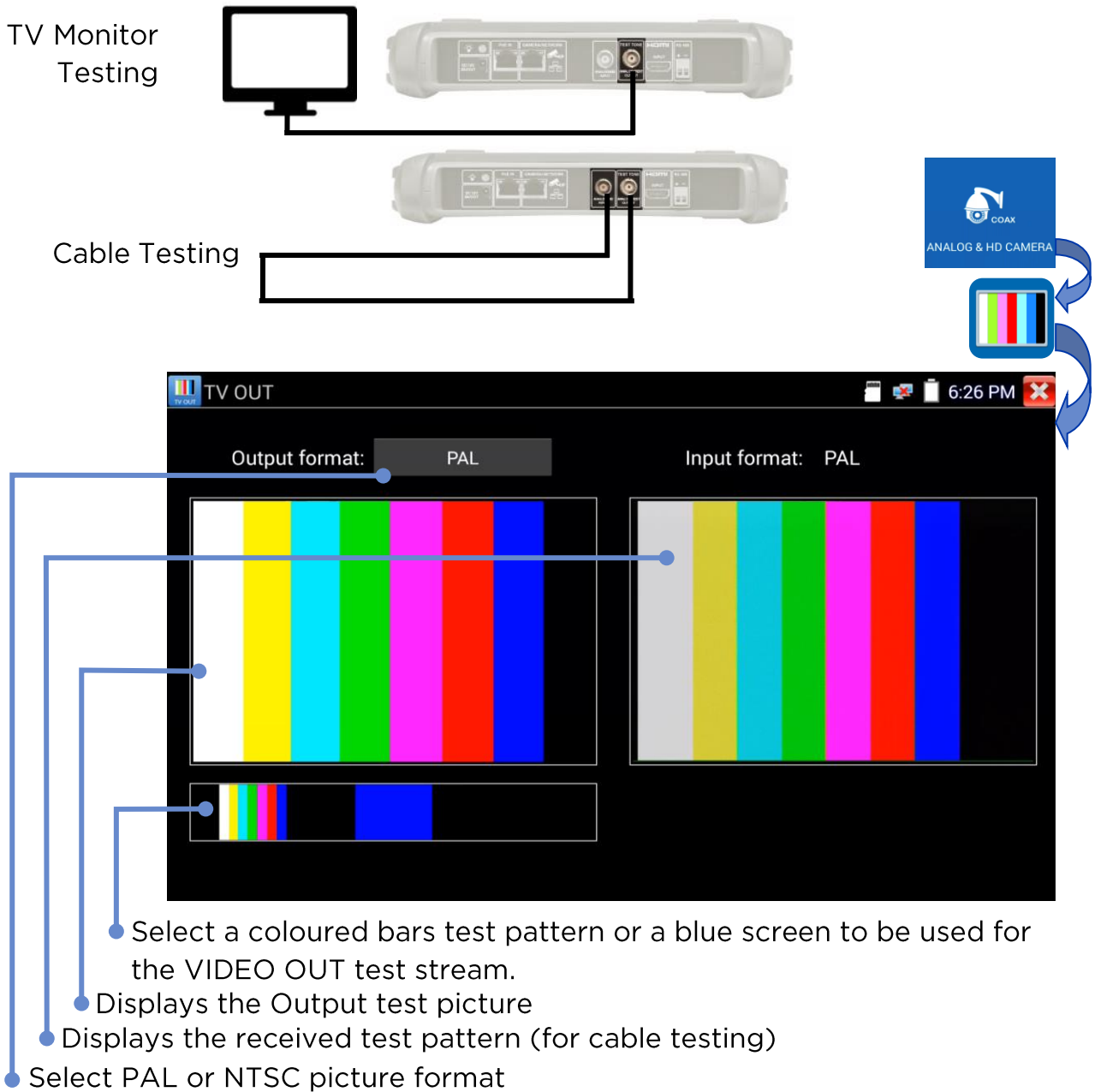



ANALOG CAMERA TEST - TVI

Cameras using the high definition Transport Video Interface (TVI) standard can be tested. HD Coax Camera - TVI/AHD/CVI are protocols that allow HD video from digital cameras to be transmitted over coaxial cable allowing improved video quality with existing cabling. SecuriTEST IP supports fixed and PTZ versions of these cameras.

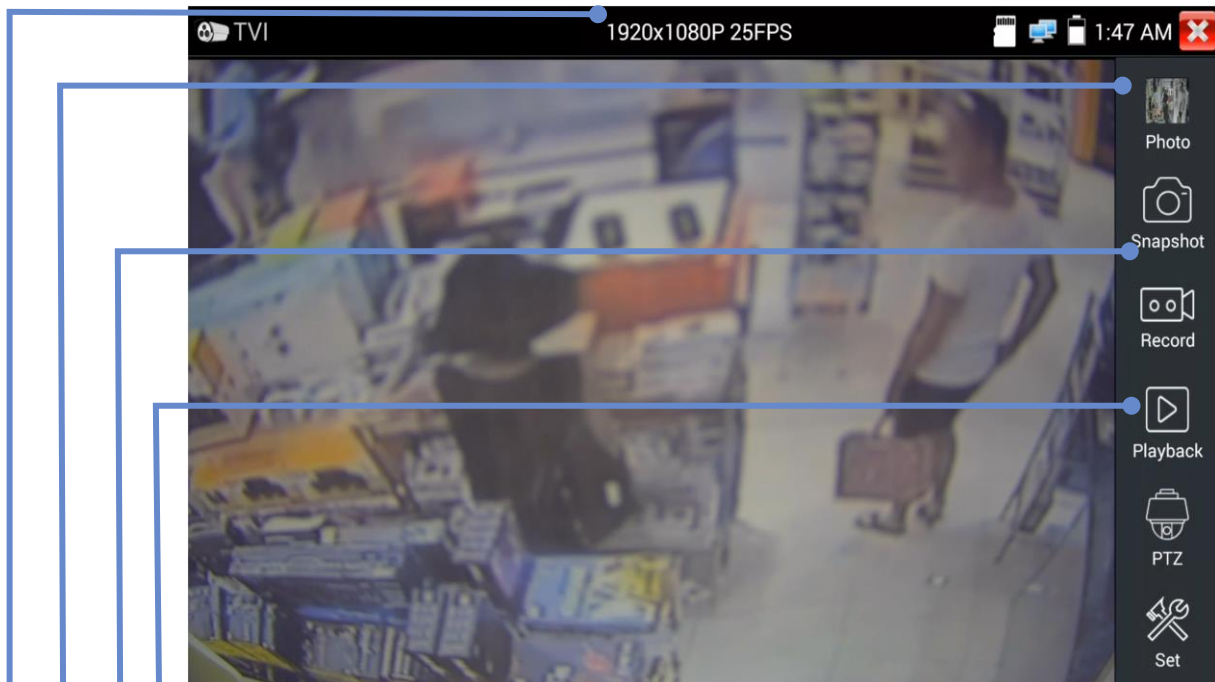
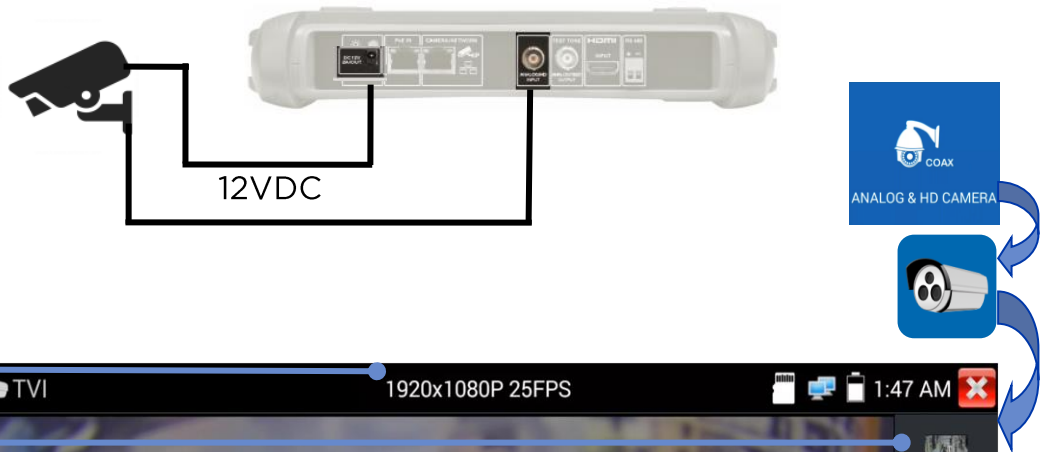

- Touch to play recorded videos.
 - Touch to capture photos and videos.
 - Touch to display captured photos.
 - Displays video format (width x height in pixels) and frame rate
- } (Common functions for all coax camera types)

- Touch Photo to select and view snapshots
- Touch Snapshot to capture a snapshot of the current scene
- Touch Record to record video. Touch Stop to stop recording
- Touch Playback to select and play video recordings
- Touch PTZ to set the Pan/Tilt/Zoom see [PTZ section](#)
- Touch Set to control Auto or manual naming of the photos and videos



ANALOG CAMERA TEST - CVI

Cameras using the high definition Composite Video Interface (CVI) standard can be tested.

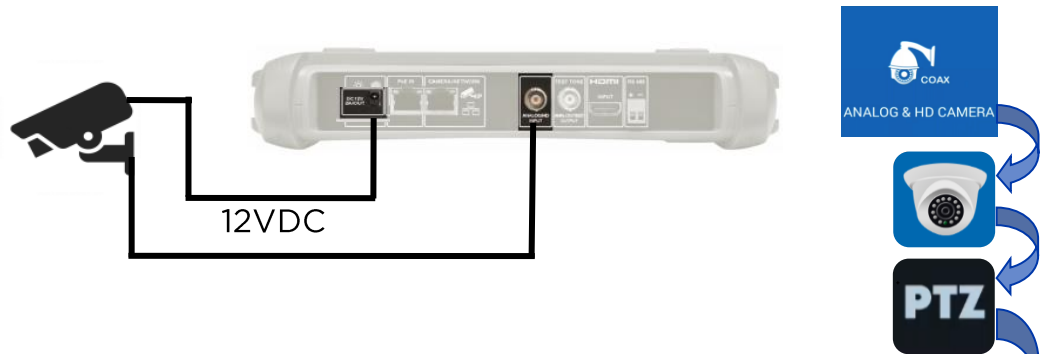

- Create and recall preset PTZ positions.
- Set response speed of PTZ controls. Common functions for all HD Coax (TVI, CVI and AHD)
- UTC or RS485 Port settings

Touch Photo to select and view snapshots

Touch Snapshot to capture a snapshot of the current scene

Touch Record to record video. Touch Stop to stop recording

Touch Playback to select and play video recordings

Touch PTZ to set the Pan/Tilt/Zoom see [PTZ section](#)

Touch Set to control Auto or manual naming of the photos and videos



ANALOG CAMERA TEST - AHD

Cameras using the Analog High Definition (AHD) standard can be tested.

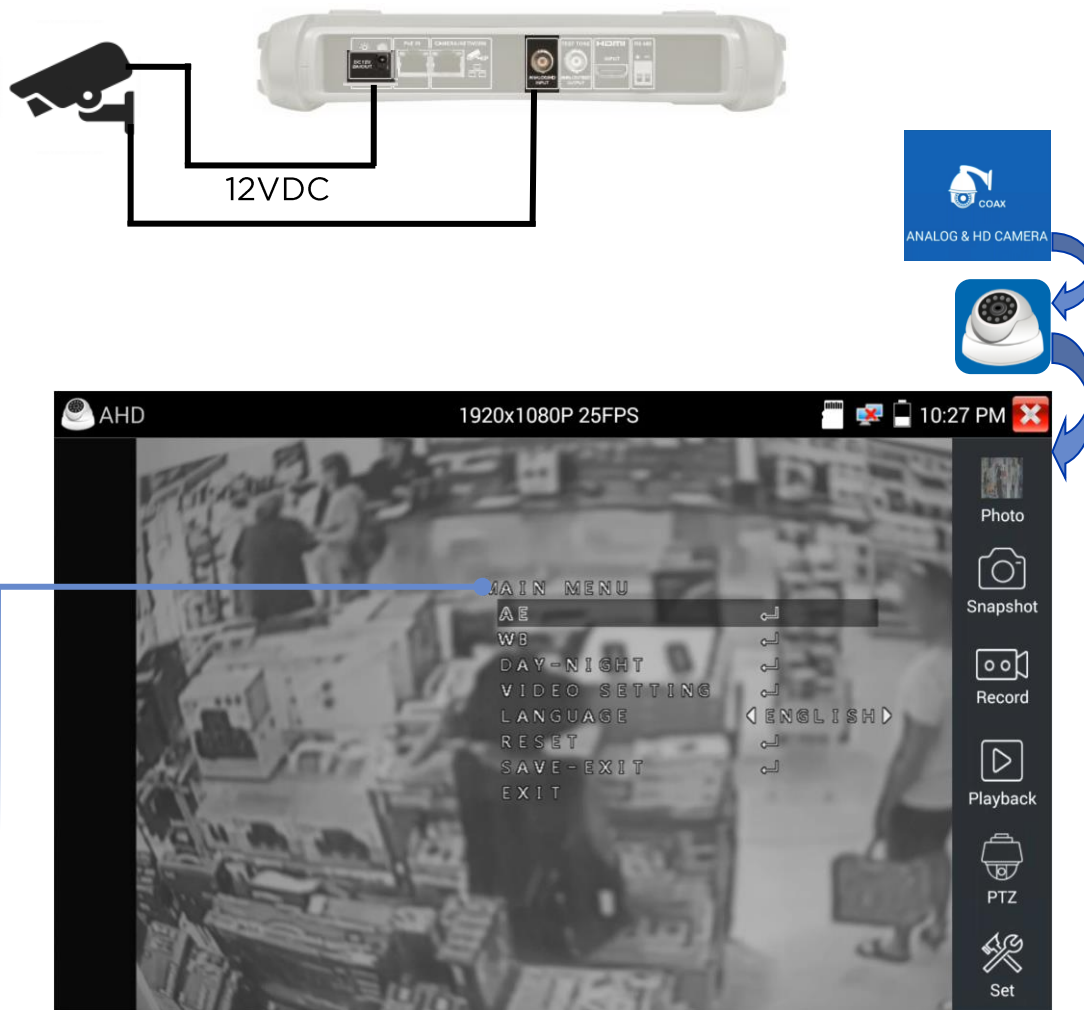

- Navigate and use the camera-based settings menus with the On Screen Display (OSD) menu navigation controls. (Also supported on TVI, CVI and Coax cameras.)

Touch Photo to select and view snapshots

Touch Snapshot to capture a snapshot of the current scene

Touch Record to record video. Touch Stop to stop recording

Touch Playback to select and play video recordings

Touch PTZ to set the Pan/Tilt/Zoom see [PTZ section](#)

Touch Set to control Auto or manual naming of the photos and videos



CABLE TESTING - Cable Test

Cables connected between the Cable Test port and the UTP port of a Cable Tracer / Remote (powered by two AAA batteries - not included in package) can be checked for correct continuity and identified as straight-through or crossover cables. (Note - not for STP cables)

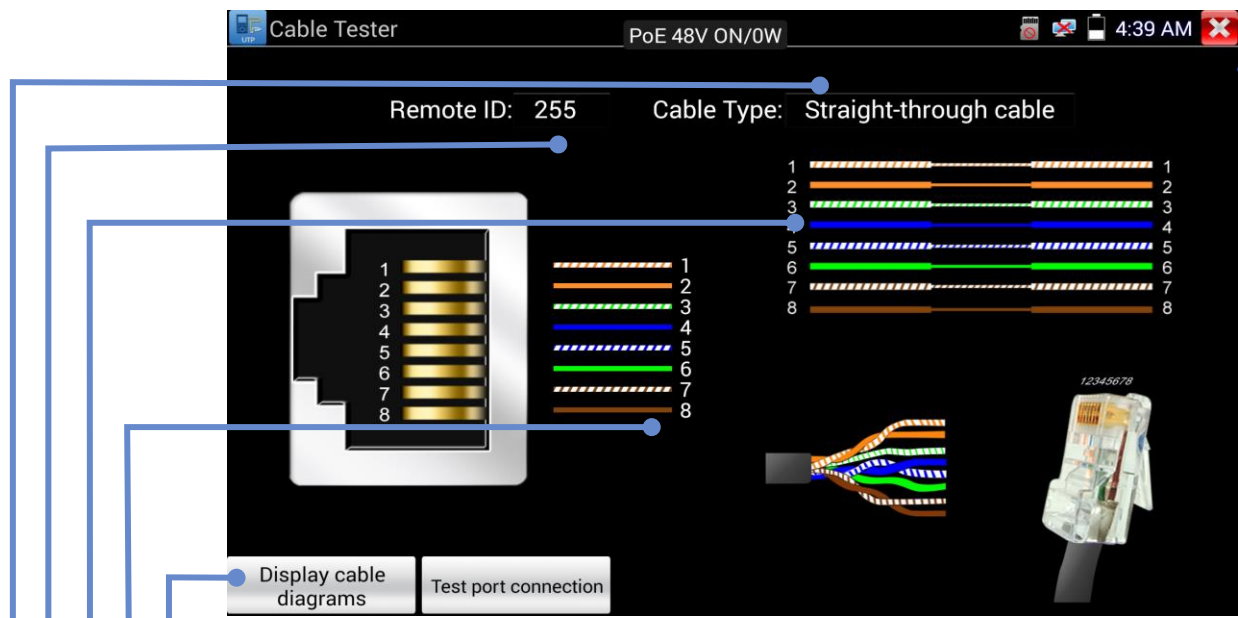
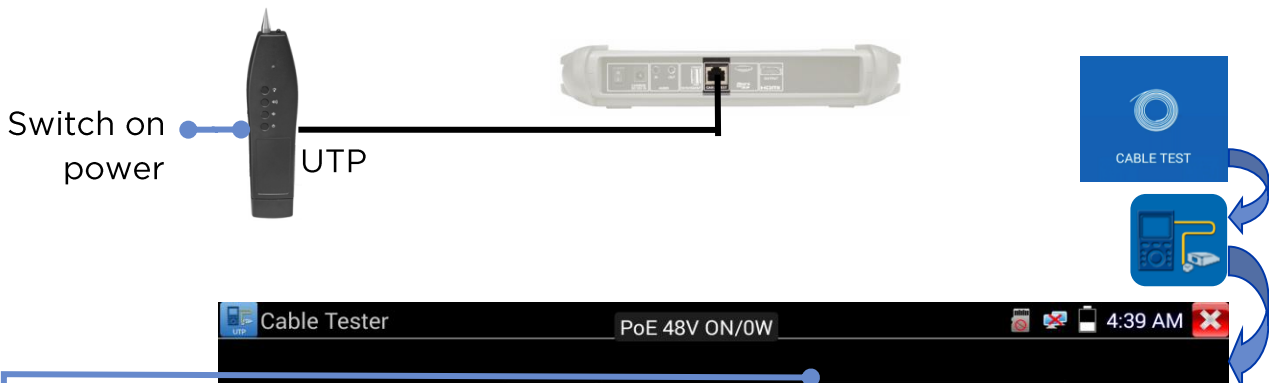

- Touch to display wiring diagrams for straight-through and crossover cables
- Diagrams showing the colour code and pin numbers. Faulty pins are shown by a red cross
- Displays the end-to-end connections of the cable being tested (only if the test has passed)
- Displays the ID number of the remote
- Displays the detected configuration of the cable being tested.



CABLE TESTING - RJ45 cable TDR

A Time Domain Reflectometer (TDR) in the tester can be used to measure the length and estimated cable quality of a cable (UTP only - not STP) with other end opened or shorted. To measure the impedance, reflectivity and skew, the cable need to be connected to a Camera / Network port. The length of each of the four individual pairs in the cable is independently measured. (Note that this test does not require a remote unit. However the skew can only be measured at 1000Mb/s when the tester is connected to an active network port such as a switch)

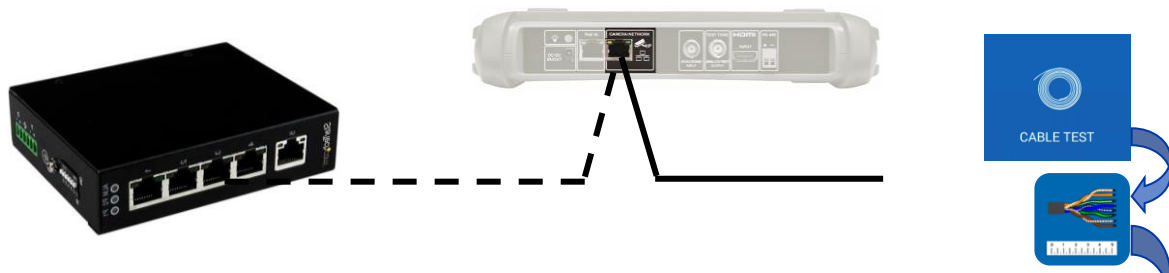

RJ45 Cable TDR test

Test once
Continuous test
Advanced test

Line pair	Status	Length(m)	Attenuation (dB/100m)	Reflectivity (%)	Impedance (Ω)	Skew(ns)
1 2	Open	20.1	-7.0	—	—	Invalid
3 6	Open	20.1	-5.9	—	—	Invalid
4 5	Open	20.1	-6.4	—	—	Invalid
7 8	Open	20.9	-5.9	—	—	Invalid

Test port connection
Display cable diagrams

Good quality cable (Green)
Poor quality cable (Yellow)
Possible contaminated cable (Red)

Touch to display wiring diagrams for straight-through and crossover cables

Touch to display diagrams of the ports

Displays open / short status of each cable pair

Displays the length of each cable pair

Displays the approximate attenuation per 100m and cable quality (good / poor / contaminated) for cables longer than 10 m. Threshold of colour is as following for 100m:

<=8dB Green

<=10dB Yellow

>10dB Red

Touch to start single, continuous or advanced test. Use Advanced test for reflection, impedance and skew. Use Continuous for best accuracy and result stability.



CABLE TESTING - Tone Generator

The tester can generate a digital tone on the cable (UTP only - not STP) connected to the Cable Test port. This tone can be detected using a non-contact tone probe to allow the cable to be traced.





IP NETWORK TEST - Ping

Ping is a standard network debugging tool used for testing if the connected IP camera or other network equipment’s Ethernet port is working normally and the IP address is correct.

TOOLS >> Network Tool >> Ping



Connect a network cable to the LAN port and click the  icon to open the PING tool. You can set your LOCAL (native) IP address, Remote IP address (e.g. IP camera), Packet count, Packet Size, Packet delay time and Timeout. Press “Start” to start pinging. If the IP camera or network device is not configured properly or not plugged in, it will say “Destination host unreachable,” or have 100% packet loss. If the tester connects to the device, the send and receive packets will have a 0% packet loss.

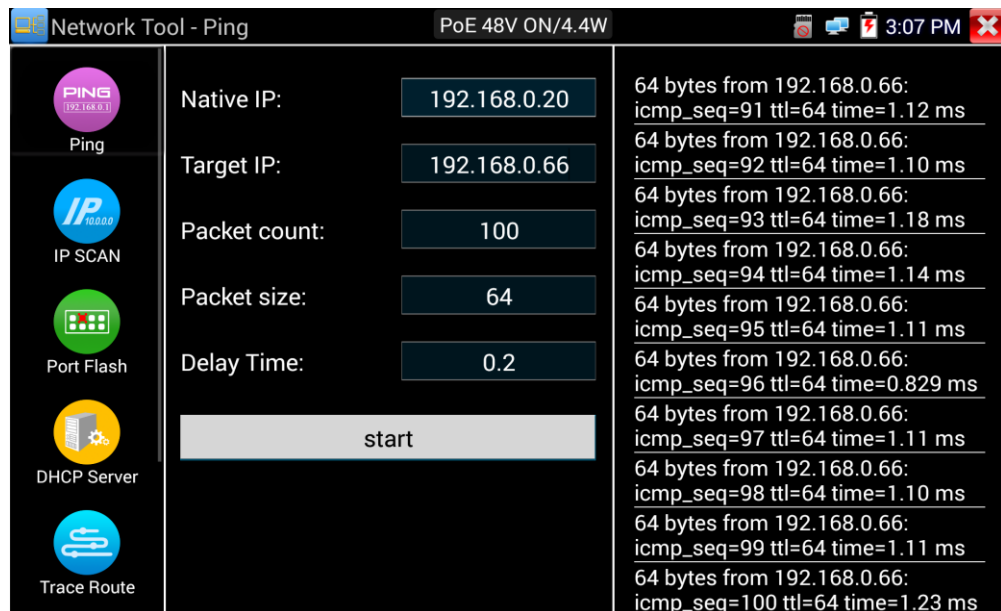



IP NETWORK TEST - IP Scan

TOOLS >> Network Tool >> IP Scan



Connect the cable to the LAN port, click icon . Set the IP address search range by changing the Start and End IP addresses. (Note that the IP Scan test can only scan within the local subnet.)

Click the “Start” button to scan the IP address range. You can also input an IP address in the Port Number Scan to scan for open ports. (Note that the port scan can take a long time and it is not recommended to use this function unless necessary.)

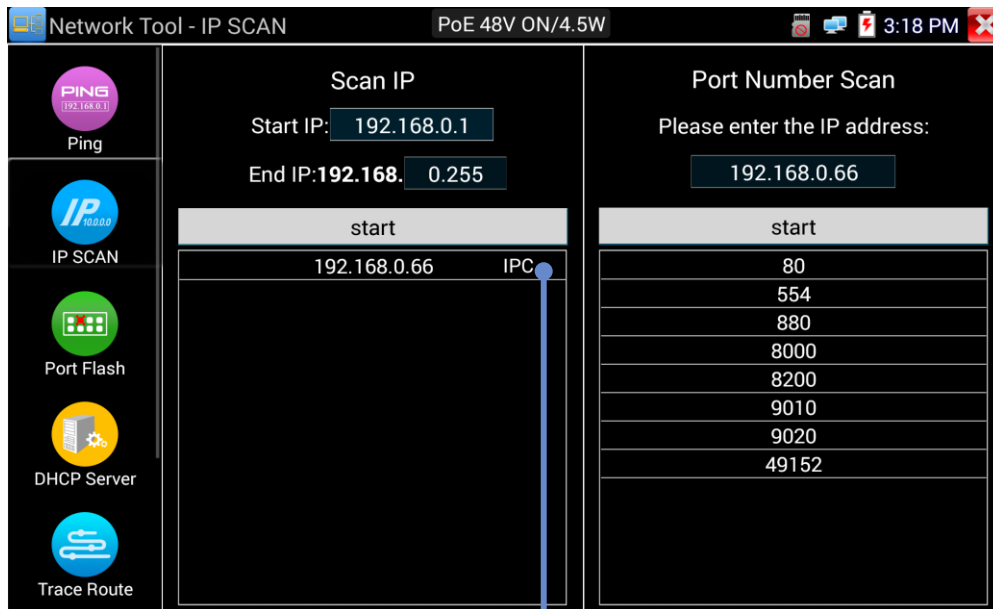

The “IPC” indication means that this may be the address of a camera.

Port number scan is mainly to check if the port is open and available for service/traffic passing through. Often it takes much longer time to test and it is not recommended to use this test unless necessary.



IP NETWORK TEST - DHCP Server

Cameras that are equipped to use the Dynamic Host Control Protocol (DHCP) can request an IP address from the tester's DHCP server instead of using a fixed IP address.

TOOLS >> Network Tool >> DHCP Server

Switch the DHCP Server on/off

CAUTION! Enabling a DHCP server in a network that already has another DHCP server enabled can cause the network to become unstable. Always consult the network administrator before enabling the DHCP server in a tester connected to a network

Set up the IP address of the tester (Note that the tester must have a static address and not be in Wi-Fi mode) Refer to IP Settings section.

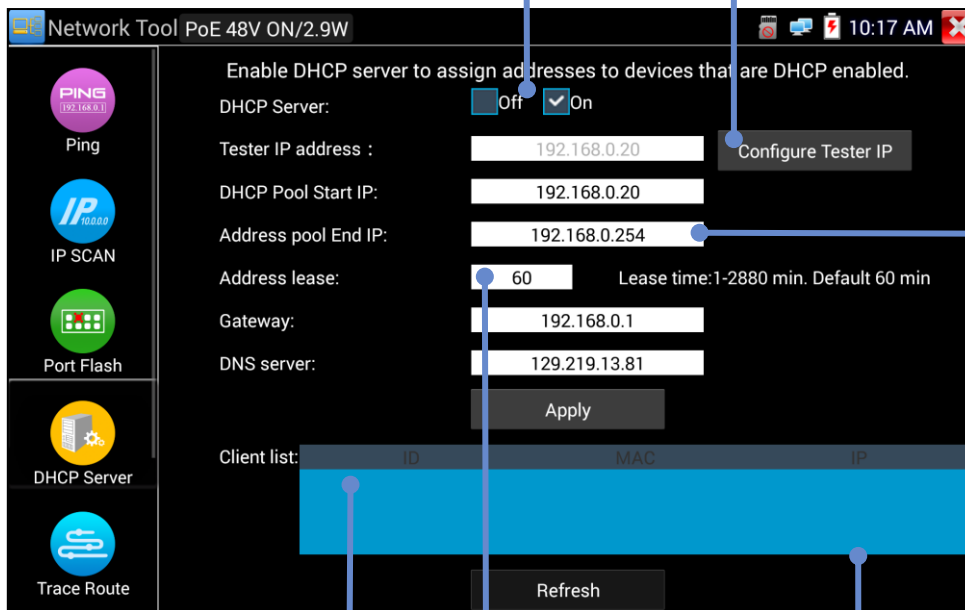

Set up a pool of addresses that the DHCP server can assign

Double-tap to display DHCP clients in the network, updated in real time

Set the length of time that the address will be valid in the camera

Lists all of the cameras that have been assigned IP addresses



IP NETWORK TEST - Available IP

TOOLS >> Network Tool >> Available IP

This tool is used to check the network to find available IP addresses. A camera with a fixed IP address will only work correctly in the network if its IP address is not already in use by another device. If the camera's IP address is already in use, it must be changed to a free one before it can be connected to the network.

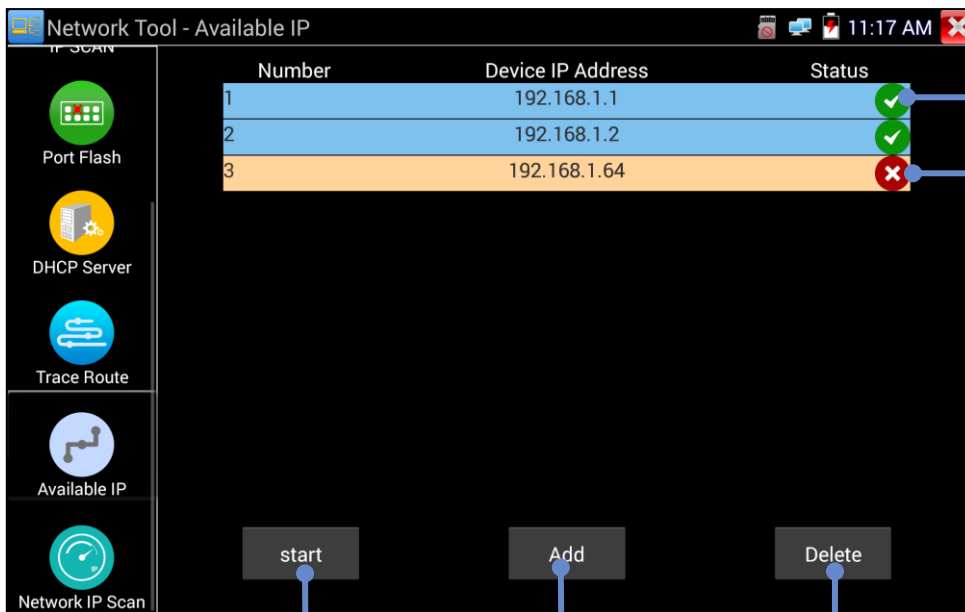

IP address is available

IP address is already in use - camera address must be changed to a free one

Start the scan

Add a new IP address to include in the scan

Remove the selected IP address from the scan



IP NETWORK TEST - Network IP Scan

TOOLS >> Network Tool >> Network IP Scan



Connect the cable to the LAN port, click icon . This test scans the network over multiple sub-nets. (Note that this can take a long time to complete.)





IP NETWORK TEST - Data Monitor (RS485)

This tool is used to check the RS485 communication codes transmitted by a DVR or control keyboard.

TOOLS >> Data Monitor

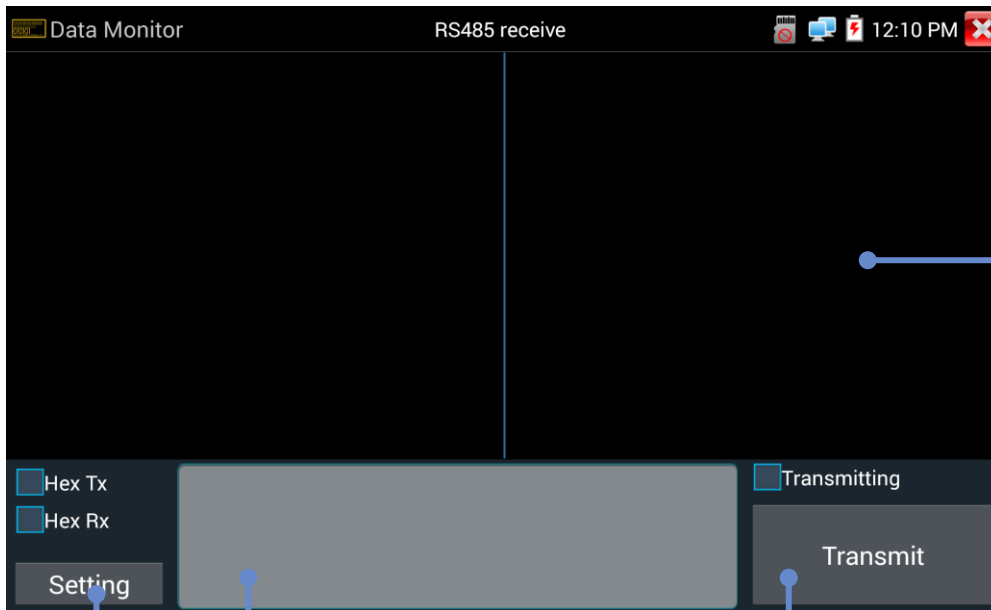

Transmitted and received messages

Adjust the port settings:

Edit the message

Transmit the message

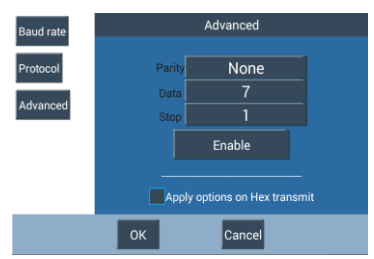
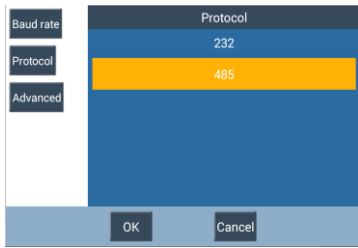
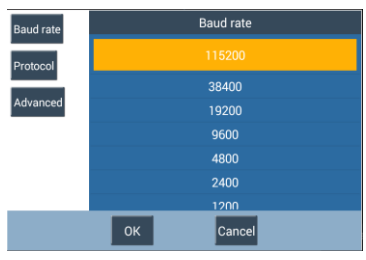



RESULTS AND TRANSFER - Test Report



The final step in testing and commissioning cameras is to record the testing in the form of a Test Report that can be given to the client as proof of correct installation and operation.

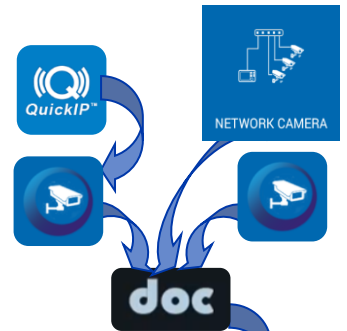

Touch to open the report information window

Touch a saved report to select it for viewing

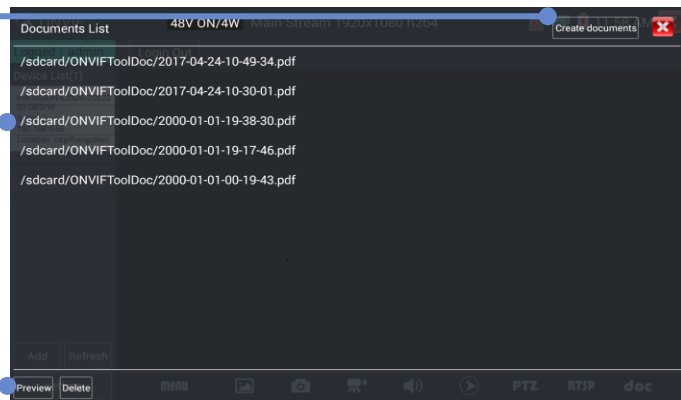

Touch to open the selected report

Report Information Window

Touch to create and save the report



Fill in the project and operator details

Touch to attach snap shots and logo for the test report

PDF is created and stored on the internal storage in the JOBS folder.

SecuriTEST™ IP Test Report

Job/Project name :	City Plaza	Operator :	IDEAL NET
Ticket/Ref /Job No. :	A14357	Address :	1375 PARK AVE
Location/Building :	NE Can 02	City/Town :	SYCAMORE
Address :	1234 Main St	ZIP/Postal Code :	IL 60178
City/Town :	Anytown	Country :	USA
State/Province :	NC	Tel :	800-435-0705
ZIP/Postal Code :		email :	contactus@idealnetworks.net
Country :	USA		
<hr/>			
Tester Name :	SecuriTEST IP	Test Time/Date :	2017-04-24 10:42:17
Serial No. :	2017011600010538	Hardware version :	WH-K2-X7V1.1.0-V1.1.0-7112A
Software version :	V01.00 015	Time zone :	GMT+00:00
<hr/>			
Device Info			
Camera name :	HIKVISION%20DS-2DE2202-DE3/W	Camera Model :	DS-2DE2202-DE3/W
Camera time :	2017-4-24 17:33:29		
<hr/>			
Network Status Info			
Ethernet port speed :	100Mb/s	Duplexity :	Full
Camera IP address :	192.168.0.66	Camera subnet mask :	255.255.255.0
Gateway :	192.168.1.1	MAC address :	bc:ad:28:c8:6d:0f
DNS :	8.8.8.8	Encoding format :	H264
Resolution :	1920x1080	Bit Rate :	3072
Frame rate :	25		
photo :			



RESULTS AND TRANSFER - JOBS

Jobs are used to organise all of the test results and resources into a folder structure in the internal storage (internal SD card). The contents are categorised by type of file:

Shortcut copies all files from internal SD card to external SD card.

2017-10-31-15-57-50.pdf
10/31/2017 15:57:52 27.43 KB

2017-10-31-15-57-50.pdf

IDEAL NETWORKS **SecuriTEST IP Test Report**

Job/Project name :	Operator :
Ticket/Ref /Job No. :	Company :
Building No. :	Street :
Street :	City :
City :	ZIP :
State :	Country :
ZIP :	Tel :
Country :	Email :

Tester Info

Tester Name :	SecuriTEST IP	Test Date & Time :	Oct. 31 2017 03:57:50
Serial No :	2017011600010538	Time zone :	GMT+00:00
Hardware Version :	1.3-1.3	Firmware Version :	
Main SW version :	V1.1.0	System SW version :	IN-K2-X7V1.1.0-V1.1.0-7112A



RESULTS AND TRANSFER - File Explorer

The File Explorer provides a method for navigating the file structures of the various tester memories, including the internal and external SD cards.

MY APPS >> File Explorer

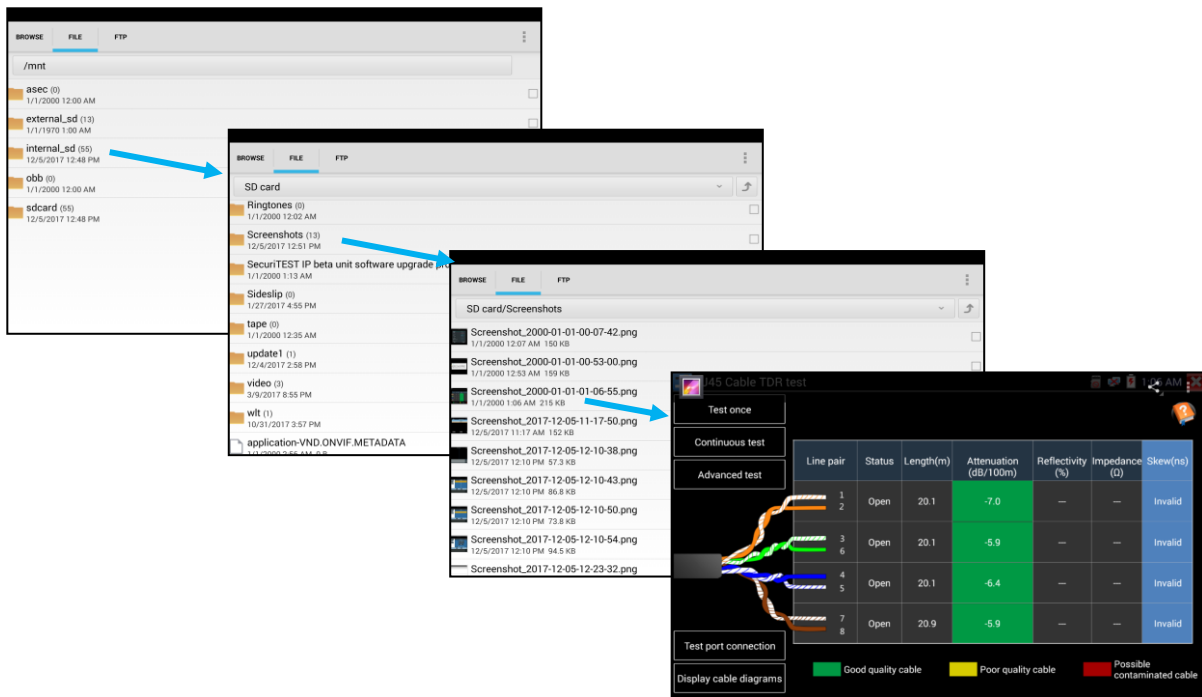

To Copy a file to another folder in the tester:

- Navigate to the file
- Either:
 - Select the file by ticking the box on the right hand side of the screen
 - Tap the  icon at the top of the screen
- Or:
 - Touch and hold the file name
 - Select **Copy** from the menu
- Navigate to the destination folder
- Tap **Paste**



To Copy a file from the tester to another device (PC or smart device):

- [See File Transfer section](#)



RESULTS AND TRANSFER - File Transfer

Three methods can be used to transfer files to and from external devices such as PCs and smart devices:

1. Removable Micro SD card

- Use the Copy / Paste procedure described in the Jobs section to copy the required file(s) on to the external SD card
- Eject the SD card by pushing it inwards
- Insert the SD card into an SD port or SD / USB adapter (provided as standard accessory) in the target device
- Copy the required file(s) into the appropriate folder in the target device.
- (Reverse the process to copy from the external device to the tester)

2. File Transfer Protocol (FTP)

MY APPS >> File Explorer>> FTP

An FTP server can run in the tester. ([See FTP server.](#)) This can be accessed by an external device connected via a Wi-Fi or wired network.

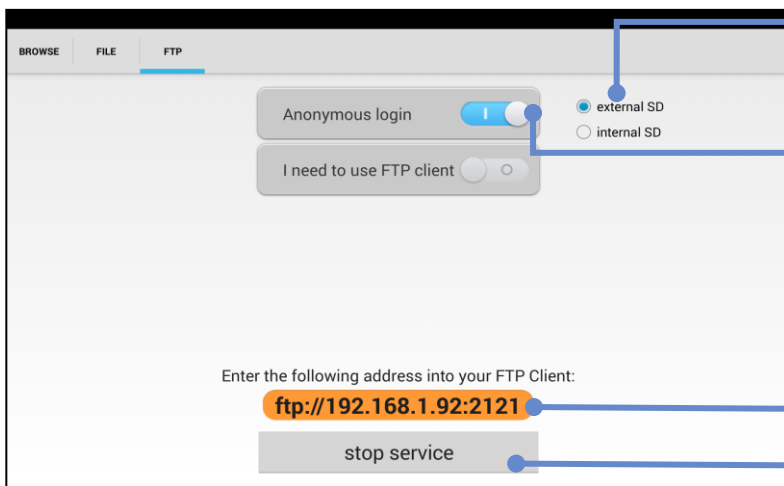

Select external or internal SD card

Select Anonymous login (no password required)

This is the FTP address of the tester. Enter it into the URL bar of the browser.

Tap to start the FTP server ([See FTP server](#))

3. Internet

Files can be sent and received over the Internet using applications such as web e-mail or Dropbox as illustrated on the right.

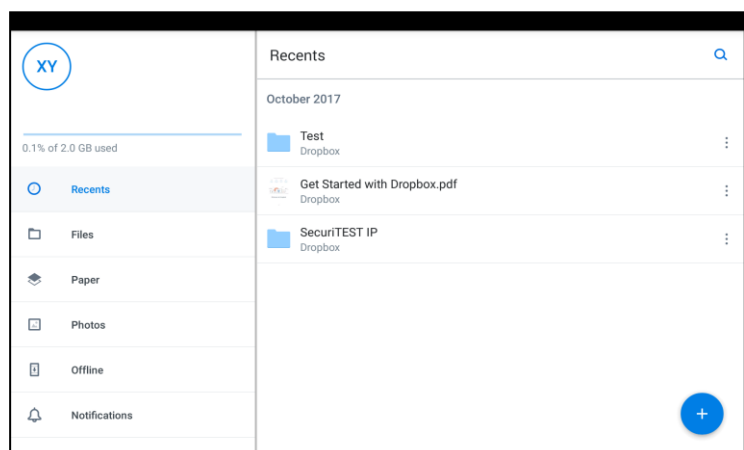



MY APPS - Rapid Video

Rapid video is an App that allows the tester to quickly detect all cameras in the connected network and to display the video streams. It quickly combines IP Discovery and ONVIF into a single operation.

MY APPS >> Rapid Video

The tester automatically connects to a camera and displays the video stream ([see ONVIF](#)):



If the camera is disconnected, tap Refresh to re-connect :

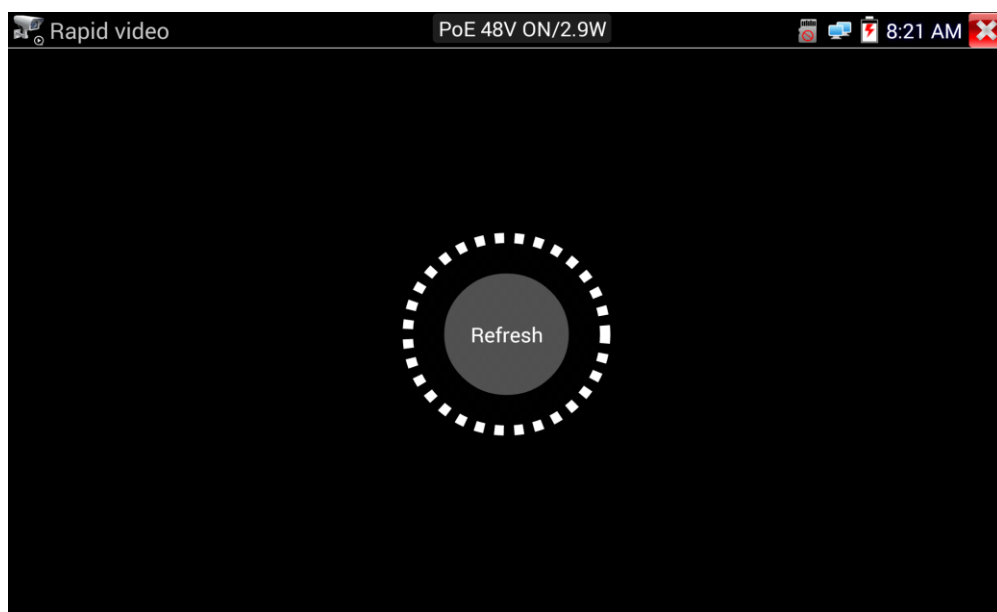



MY APPS - HIK

The HIK App searches for all Hikvision cameras in the network and allows the user to activate any cameras and to view the video streams from them. This is specially designed for Hikvision cameras and mainly used for large scale or batch camera configuration to improve the efficiency.

MY APPS >> HIK

Tap to refresh the search list

Indicates the IP details of the selected camera

Enter the login details of the selected camera

Play the video stream from the selected camera

Modify / reset the settings

Tap to login to the selected camera

Out of the box cameras need to be activated before they can be used. Tap to activate the selected camera

Lists the available cameras and their activation status. Tap a camera to select it

Number	Type	IP address	Safe mode
1	DS-2DE2202-DE3/W	192.168.0.66	Activated

Detail :

- IP address : 192.168.0.66
- Subnet Mask : 255.255.255.0
- Gateway : 192.168.1.1
- S/N : DS-2DE2202-DE3/W
- Username: admin
- Password : Show
- Login
- Play
- Modify network
- Modify user
- Activation
- Factory Reset



MY APPS - DH

The DH App searches for all Dahua cameras in the network and allows the user to activate any cameras and to view the video streams from them. This is specially designed for Dahua cameras and mainly used for large scale or batch camera configuration to improve the efficiency.

MY APPS >> DH

Tap to refresh the search list



Indicates the IP details of the selected camera

Enter the login details of the selected camera

Play the video stream from the selected camera

Modify / reset the settings

Tap to login to the selected camera

Out of the box cameras need to be activated before they can be used. Tap to activate the selected camera

Lists the available cameras and their activation status. Tap a camera to select it



MY APPS - RTSP Player

The RTSP Player app will allow you to view the RTSP video stream from an IP camera. If you were unable to view your camera via the ONVIF or Test apps, it is possible your camera will have an RTSP stream and you can view live video using this method.

MY APPS >> RTSP Player

The screenshot shows the RTSP Player app interface with the following callouts:

- Indicates the tester's IP address**: Points to the 'Local IP' field containing '192.168.0.254'.
- Edit the tester's IP address**: Points to the 'Edit' button next to the 'Local IP' field.
- Set the user name and Password of the IP camera**: Points to the 'IPcam Username' field containing 'admin' and the 'IPcam password' field containing '.....'.
- Tap to view the RTSP stream**: Points to the 'Enter' button at the bottom left.
- Set up or scan for the Camera's IP address**: Points to the 'Camera IP address' field containing 'Click Set to Scan or Manual Input'.
- Tap to search for RTSP enabled cameras in the network and to select one from the list**: Points to the 'Search' button at the bottom right.



SOFTWARE UPDATE - Local Update

The tester software can be updated in two ways - Manual and Auto update. Auto is recommended for end users and Manual is for IDEAL and service engineers to use.

Note: The AUTO function will only update the IDEAL Networks' own software. Any third party software will not be updated automatically unless MANUAL update is used.

SETUP >> System >> Update

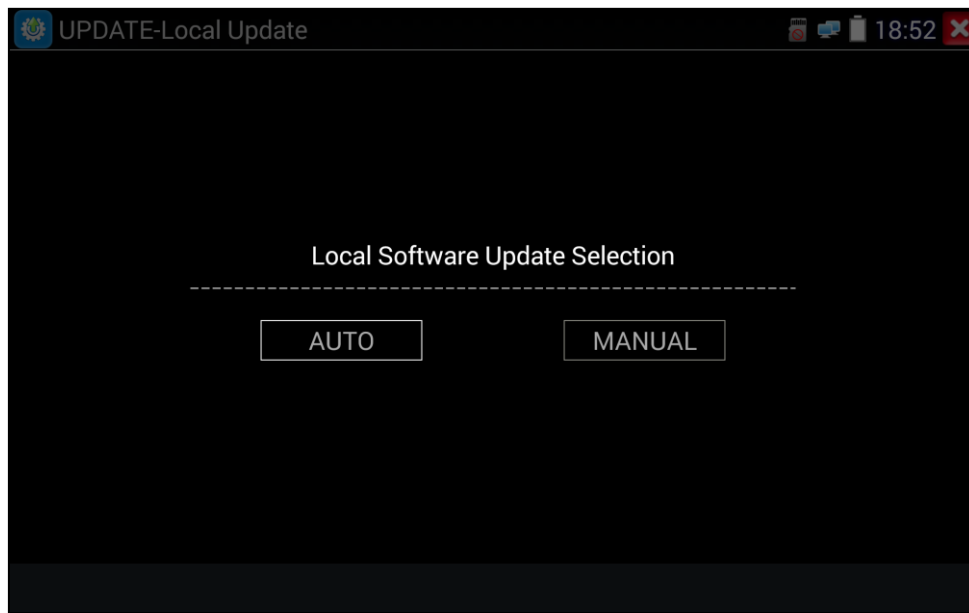

Note: Users who install / update unapproved third party APPs into the tester take full responsibility for the consequences. IDEAL Networks will not take any responsibility or support these APPs if operation issues are caused.



TOOLS - Notepad

Notepad is a useful tool for making notes about the tests to attach to Test Reports

TOOLS >> Notepad

Write a new text note

Open an existing text file:

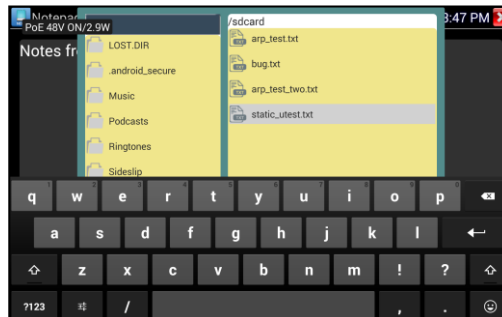

Save the new text note to a file:

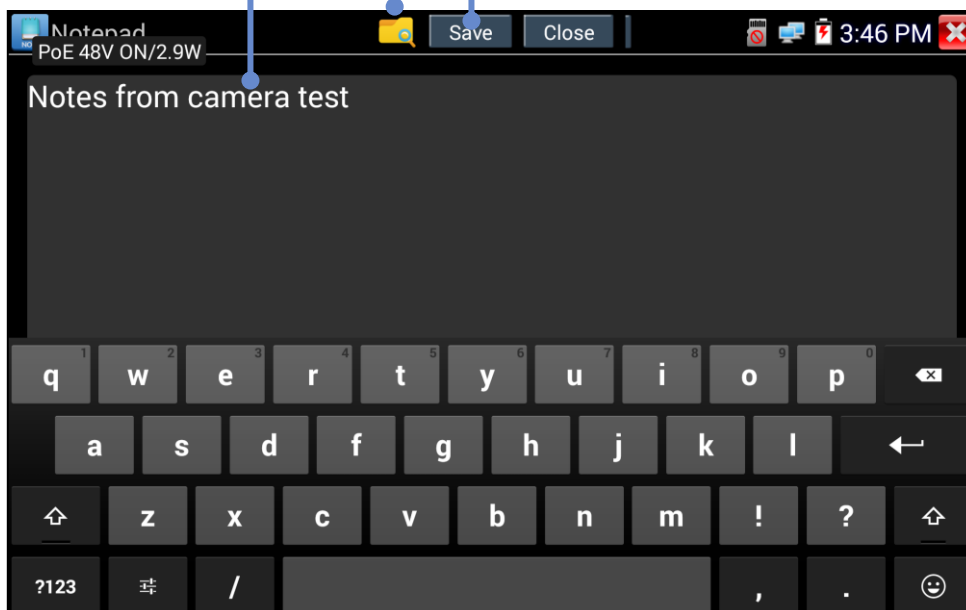



TECHNICAL SPECIFICATION - Interfaces:

Ethernet port:

- Ethernet 100Base-T - LAN/Network/Camera/RJ45 TDR test (1000Base-T)

RJ45 port:

- PoE IN - Pass-through PoE to the Ethernet port only no data pass through.
- Cable test - Cable test only Not Ethernet, no network connection.

Wi-Fi:

- Built in Wi-Fi 802.11b/g/n (2.4GHz only) up to speed 150Mb/s client to access the network for testing.

Coax port:

- BNC (f) video IN/HD Coax IN – Analog, TVI, CVI, AHD input
- BNC (f) video out – Analog video bar output

RS485 port: RS485 male “Phoenix” type connector for PTZ control and communications test

HDMI port:

- **HDMI IN:**
 - HDMI supports: 720×480p /720×576p /1280×720p /1920×1080p /1024×768p/1280×1024p /1280×900p /1440×900p video formats.
 - Does not support HDCP copy protected video sources
- **HDMI OUT:** 1 channel HDMI output 1280x720p, 1920x1080p user selectable.

Audio port:

- **Audio IN:** 3.5mm female socket for audio line in
- **Audio Out:** 3.5mm female socket for audio line out

DC output: 4.0x1.7mm female socket for 12V/2A DC output (center positive polarity)

USB port: Type A USB on 5V/2A DC power output only (No data transfer)

SD card slot: MicroSD card reader

DC input: 12V DC charge port with 5.5x2.1mm socket. Tester can operate and charge battery simultaneously.

LED Indication

Battery:

- **ON** - charging,
- **OFF** - fully charged when charge is ON or
- **OFF** - no charging when charge is OFF
- **Flash** - no battery fitted (charge LED is ON)

Charge: DC 12V IN is ON

Tx & Rx:

Flash - Tx & Rx data for RS485

ON - Standby (both Tx & Rx ON)



TECHNICAL SPECIFICATION – Camera Test Functions

IP Camera Test:

- **Max video input resolution:** 4K (8MP).
- **Codec support:** MJPEG, MPEG4, H.264, H.265 (mainstream)
- **ONVIF support:** relevant part of profile S,Q,G
- **IP address discovery & assign:** auto discover static IP address of direct-connected camera or assign IP address to the camera with dynamic IP address setting (from internal DHCP server) automatically.
- **Stream support:** RTSP (Real Time Streaming Protocol)
- **Non ONVIF and proprietary IP camera support:** manual IP address, port and model selection for non ONVIF supported cameras brand including ACTi, AIPU, APD, Axis, Aebell, Arecont Vision, BILL, BM, Bestecher, Bosch, CityTech, CYZ, Changying, Colin, Costar, Dahua , DOZENY, DVO, DVSONE, Devele, Etrovision, FOKO, FORSECU, FS, Finetida, GOLBONG, GREAT, Geovision, Grandeye, HI-SHARP, Hikvision, HISIDE, HZWS, HanbangGaoKe, HawKeye, Hitron, Honewell, HuiSun, hongben, ISEC, Infinova, JETVIEW, JOOAN, JOVISION, JUAN, Jbvideo, JieGao, JingShiKang, KEDACOM, KINPUS, KeJun, KumKang, LEFOUND, LILIN, LanDunSiAn, Longse, MaxxOne, NJBESTWAY, Neitway, OSKA, PN3D, Panasonic, Pelco, PengRunDa, Pinshi, QIDUN, Samsung, SANTACHI, SHIKO,SONY, STJIATU, STYCO, Safer, SecurityTronix, Seeyou, SongXin, Sunell, SuperSight, TBTEC, TIANDY, TP-LINK, TVT, TianLong, TruVue, Uniview, VIDDIACNET,VIVOTEK, VSTON,VVS-CCTV, VideoNet, Vista, WAPA, WATCHMAN, WEISKY, Woshida, XiangWei, XinLong, YH, YIDUN, YJX, YS, YXAF, YueTian, YunShiAn, ZKTeco, ZLD ...
- **PTZ, focus, aperture:** Key pad and screen gesture to control of aperture, zoom, focus, pan, tilt.
- **Digital zoom:** Up to 20 times (subject to camera availability)
- **Rapid video:** One key discovery of active network cameras and access to camera setup and programming via ONVIF.

Web browser: Chrome

Analog (CVBS) camera test:

- **Video input:** 1 channel analog CVBS signal PAL & NTSC auto detection
- **Video level meter:** Peak video signal level, Sync signal level, Colour, Chroma level measurement
- **Video output:** colour bar, blue or black full screen in NTSC or PAL formats.
- **Dual window display:** CVBS floating on screen and IP camera test results at the same time for analog and IP converter test monitor
- **PTZ control:** Supports RS485 control, Baud 600-115200bps, Compatible with more than 30 protocols such as PELCO-D/P, Samsung, Panasonic, Bosch etc. (detail see HD Coax PTZ part)
- **PTZ address scan:** auto detect camera's PTZ address
- **PTZ data monitoring:** Captures and analyses the command data from PTZ controller. Manual transmit of hexadecimal codes in RS485 for PTZ control testing.

HD Coax (TVI, CVI, AHD) camera test:

- **TVI:** 8MP (4K) 3840 x 2160 15 fps, 5MP 2592 x 1944P 12.5/20 fps, 4MP 2688 x 1520P 15fps; 2560 x 1440P 15/25/30 fps, 3MP 2048 x 1536P 18/25/30 fps, 2MP (1080P) 1920 x 1080P 25/30 fps, 720P 1280 x 720P 25/30/50/60 fps, UTC control/call OSD menu
- **CVI:** 8MP (4K) 3840 x 2160 12.5/15 fps, 4MP 2560x1440P 25F/30 fps, 1080p 1920 x 1080P 25/30 fps, 720p 1280 x 720P 25/30/50/60fps, UTC control d call OSD menu
- **AHD:** 5MP 2592 x 1944P 12.5/20 fps, 4MP 2560x1440P 15/25/30 fps, 3MP 2048x1536P 18/25/30 fps, 1080p 1920x1080P 25/30fps,720P 1280x720P 25/30 fps ,UTC control d call OSD menu
- **Images:** Snapshot/view, video record/play, screenshot
- **PTZ control:**
 - **Port type - UTC Coaxitron*:**
 - PTZ - Address, pan speed, tilt speed, set & recall position
 - Menu - arrows control with address
 - **Port type - RS485:**
 - **Protocol:** ALEC, AD168(M-B), Bosch OSRD, CBC, DAT-SD, DH-YTC06, Fastrax, HD600, Hikvision, Kalatel ASC, LC-NEW, LG-MULTIX, Lilin-FAST, Lilin-MLP2, Minking A01, Minking B01, Molynx, Panasonic, Pelco D, Pelco P, Samsung, Samsung SPD, SIEMENS, SONY-EVI, Santachi, TeleEye DM2, Vcltp, Vicon, WV-CS850, YAAN, YAAN-0, YAAN-1
 - **Baud rate:** 150, 300, 600,1200,2400,4800,9600,19200, 38400,115200
 - Address, Pand & Tilt speed, Position set & Recall
- **Zoom:** Key pad control manual & digital (5x max)



TECHNICAL SPECIFICATION – Electrical Test Functions

Power output:

- **PoE:** DC48V PoE/PoE+, 24W max
- **DC 12V:** DC12V/2A power for IP & analog cameras
- **DC 5V:** DC5V 2A power output via USB to charge portable devices

PoE & Voltage test

- **PoE IN:** voltage, power and pins used
- **LAN/Network:** voltage, power and pin used
- **12V DC IN:** voltage, power consumed (operating and charging power consumption)
- **12V DC OUT:** voltage, power consumed by attached device
- **PoE link check:** PD (Powered Device) port on cable Tracer/Remote Test's PoE status of link and pairs used with LED indicators for 12,36 or 45,78 pins.

Ethernet cable test:

- **Twisted-pair test:** Reports: – straight, crossed-pair, open, short and cross-over (MDI-MDIX) with Tracer/Remote.
- **RJ45 TDR test:** Length 180m (max), Resolution +/-1m; estimated attenuation (dB/100m or dB/100feet) with good, poor and bad colour status; reflection %; impedance (Ω); delay skew (when connected to 1000Mb/s network device only), pin number with pair length. Continuous and single test mode.
- **Digital Tone generator:** 4 different tone selections for cable tracing.
- **Cable trace:** Trace and locate cables with the included Tracer/Remote. Digital tone technology eliminates electrical noise/hum associated with traditional analogue tracing probes. Eight (8) volume levels, headphone jack for use in noisy environments, non-conductive tip to prevent short circuits and integrated LED flashlight. Requires 2 x 1.5V AAA (LR03) batteries (not included).



TECHNICAL SPECIFICATION – General Test Functions

IP Network test:

- **Traffic monitoring:** real-time upstream/downstream bandwidth histogram, tester IP address and link speed and full/half-duplex condition.
- **Ping:** Local & destination IP address, packet size, number of ping tests and inter-packet delay.
- **IP Scan:** Scan for active devices within selected IP address range (subnet). Scan selected IP address for available TCP/UDP port services.
- **Port flash:** Flash the link LED on of the switch to visually identify the port to which SecuriTEST IP is connected.
- **DHCP Server:** Fully configurable DHCP server to allow dynamically configured devices to operate when a network router is not installed. Start/stop IP address range, lease time, connected client list display.
- **Trace Route:** Display IP address and delay time of up to 30 hops (routers) between device and target URL/IP address.
- **Available IP:** Create list of IP addresses and to scan for availability checking. Tester will scan each address and identify if the address is available or in use by a network device. Use to find available IP addressed when before configuring a new device with a static address.
- **Network IP Scan:** Cross-subnet IP scan on any linked network. Lists IP address of devices on multiple subnets compared to IP Scan function which only lists devices on the same subnet as the tester.

Media playback/record applications:

- **Video:** RTSP player, Video player, VLC
- **Audio:** Audio recorder, Audio player

Image capture:

- Capture still image from connected camera (can be attached to test reports).
- Record video stream from connected camera.
- Capture current tester screen.

Audio:

- **Audio IN:** 1 channel audio signal input from camera to record, listen and play via media player or audio recorder/player; 2.5 mm (1/8") connector.
- **Audio OUT:** 1 channel audio signal output to monitor audio from cameras with microphone; 2.5 mm (1/8") connector.
- **Speaker:** Internal two speakers for system indicators and audio playback from cameras or other media files.

Test report (ONVIF only): PDF format with

- Company/customer project details,
- Tester information,
 - Serial number/hardware version/firmware version/software version
 - Date/time set
- Date/time of test conducted
- Camera manufacturer/model/name/software version/Date & time
- Camera network configuration,
 - Link speed and duplex
 - IP/gateway/DNS/MAC addresses, subnet mask
 - Dynamic/static configuration
- Video stream information,
 - Video resolution
 - Frame rate
 - Bit rate
 - Encoding (CODEC) type
- Attach up to six (6) video still snapshot images,
- Operator's notes
- Attach company/customer logo

Quick Access Shortcut menu: Single button access to eight (8) user-selectable functions

Remote view: View tester screen on other network device using RTSP (Real Time Streaming Protocol).



TECHNICAL SPECIFICATION – Results, Upgrade and Help

JOBS: Shortcut to user storage area with folders for Audio/ Logos/ Photos/ Reports/ Screenshots/ Videos.

Single button copy all files/directories from internal JOBS folder to external SD card.

File management:

- **File explorer:** copy, save, delete, cut, paste, transfer to internal and external SD card
- **FTP:** results to be accessed and managed via FTP with tester configured as a server or client.
- **MicroSD card:** transfer results to other devices or install software updates.

Upgrade: Auto & manual updates from microSD card.

Help

Video introduction: a quick video clip for basic operation introduction

User guide: Context sensitive on-line help

Quick reference guide: a quick reference guide for starting to operate the tester

FAQ: a list of commonly asked questions regarding to tester operation.



TECHNICAL SPECIFICATION – General

Display:

- **Screen:** 7 inch capacitive touch screen with 1920x1200 resolution (324 ppi).
- **Screen locking:** user password setting for secured tester access.
- **Screen rotation:** rotating screen for ceiling camera adjustment before mounting.
- **Sleep timer:** 1-30 min, disengage.

Storage: 10GB internal SD card, 8GB external microSD card included (supports up to 16 GB).

Date & Time: Date, Time & time zone selection, 24 hours format, manual and auto sync.

Power: Charger: input 110-240VAC, 50/60Hz, 0.6A; output 12VDC, 2A, centre pin positive polarity; US, UK, EU, Australia AC plug adapters.

Battery:

- **Capacity:** Field user exchangeable 7.4V Lithium polymer battery, 5000mAh, 37Wh
- **Operation time:** 10 hour (typical) continuous operation without external PoE/DC12V load; 4.5hours (typical) with 3.5 watt PoE camera load.
- **Charge time:** < 8 hours from empty.

Language: English, French, German, Spanish, Italian, Portuguese, Chinese

Length units: meter, feet

Operating Temperature: -10°C - +50 °C (50 °F - +122°F)

Operating Humidity: 30% - 90%

Dimension 252 mm x 160 mm x 48 mm/ 10.0 in x 6.3 in x 1.9 in (approximate)

Weight: 1.0 Kg/2.2 lbs (including battery)

Standard compliance

CE RED directive:

- EN 60950-1:2006+A11:2009+A1:2010+A12:2011+A2:2013
- EN 301 489-1 V1.9.2 (2011-09)
- EN 301 489-17 V2.2.1 (2012-09)
- EN 300 328 V1.9.1 (2015-02)
- EN 62479:2010

FCC:

- FCC Part 15 Subpart B

RoHS:

- EN62321:2012
- EN 14372:2004
- EPA 3540:1996

Tone Tracer/Remote CE directive:

- EN55032:2015
- EN61000-3-2:2014
- EN61000-3-3:2013
- EN55024:2010+A1:2015



IDEAL NETWORKS

IDEAL INDUSTRIES LIMITED
Stokenchurch House, Oxford Road, Stokenchurch,
High Wycombe, Bucks, HP14 3SX, UK.

www.idealindustries.net

A subsidiary of IDEAL INDUSTRIES INC.



IDEAL INDUSTRIES, INC.