

Technical Specifications

MOBOTIX MOVE 2MP Vandal Fixed Dome Analytics Camera

Performant 2MP, full HD 1080p resolution camera with integrated Video Analytics features for the daily security and surveillance needs. The camera performs fast and reliable auto focus and adapts to different indoor and outdoor scenes.

- EverClear coating of dome
- Motorized Remote Zoom & Focus
- Motorized Vari-Focal Lens 2.7 to 12 mm, F1.6 to F2.9 with One-Push Auto Focus
- Wide Dynamic Range (WDR) max. 130 dB
- MOBOTIX MxMessageSystem communication system
- Integrated Video Analytics
- Integrated IR LEDs up to 40 m Distance
- ONVIF Profile S/G/T/M support
- Triple Power Support (PoE/12 VDC/24 VAC)
- Extended Temperature Range: -40 to 60 °C/-40 to 140 °F
- IP66 and IK10
- Quick Connection Mount



Technical Specifications

MOBOTIX 2MP Vandal Fixed Dome Analytics Camera

Product Information

Product Name	2MP Vandal Fixed Dome Analytics Camera
Order Code	Mx-VD3A-2-IR-VA

Image Quality

Image Sensor	5MP, 1/2.7" Progressive CMOS
Effective (Used) Pixels	H x V = 1920x1080 (2MP)
Pixel Size	2.0 μm
Frame Rate (maximum)	H.265/H.264: 1920x1080 @30 fps + 720x480 @30fps MJPEG: 1080p @30fps

Dome Coating	Superhydrophilic MOBOTIX EverClear nano coating transforms water droplets into an ultra-thin water film upon impact. The coating ensures best image quality in rain and difficult external conditions and it reduces reflections and noise in low-light scenarios. EverClear is dirt-repellent and increases the stability as well as the scratch-resistance of the dome, further reducing maintenance efforts. Coating endurance up to 3 years depending on environmental conditions and cleaning treatment.
--------------	---

Lens

Minimum Illumination	Color: 0.08 lux B/W: 0.008 lux
Lens Characteristics	Motorized Lens: Zoom, Focus, P-IRIS Focal Length: 2.7 to 12 mm Aperture: F1.6 to F2.9 Horizontal Field of View: 102.1° (Wide), 31.5° (Tele) Vertical Field of View: 70.3° (Wide), 22.7° (Tele)
Lens Mechanics	3-Axis adjustment

Camera

Day/Night	Automatic mechanically switchable IR-cut filter
Shutter Time	Manual Mode: WDR: up to 1/67500 s Linear: up to 1/67500 s Automatic Mode: Up to 1/10000 s
WDR	Up to 130 dB Multi Exposure WDR & HDR Engine support
Zoom	Optical: 4.4x, Digital 10x
Image settings	Color, Brightness, Sharpness, Contrast White Balance, Exposure Control 2DNR, 3DNR, NR by Motion Masking, Text Overlay
Corridor Mode	90°, 180°, 270° Rotation

Video Codec

Compression/Encoding	H.265/H.264/MJPEG
Streaming	Up to 4 individually configurable streams in H.264/H.265/MJPEG Configurable resolution/frame rate/bandwidth LBR/VBR/CBR in H.265/H.264

Audio Codec

Compression/Encoding	G.711/G.726/AAC/LPCM
Streaming	2-Way, bidirectional
Audio Input	Line In: Max 6.2 Vpp Signal In, Input Impedance: 33 k Ω
Audio Output	Line Out: 1 Vrms Signal Out, Output Resistance: 200 Ω

Network

Interface	10/100 Mbps Ethernet
Security	User Authentication/HTTPS/IP Filter/IEEE 802.1x

Technical Specifications

MOBOTIX 2MP Vandal Fixed Dome Analytics Camera

Supported Protocols	iARP, PPPoE, IPv4/v6, ICMP, IGMP, QoS, TCP, UDP, DHCP, UPnP, SNMP, SMTP, RTP, RTSP, HTTP, HTTPS, FTP, NTP, DDNS, SMBv2
ONVIF conformance	Supports profiles S/G/T/M
Supported Browsers	Microsoft Internet Explorer 10 or higher, Google Chrome, Mozilla Firefox, Apple Safari; Microsoft Internet Explorer with ActiveX is recommended for best performance and H.265 support

System Integration

Base Video Analytics	<ul style="list-style-type: none">▪ Motion detection▪ Tampering▪ Noise detection (ext. microphone required)
----------------------	---

Enhanced Video Analytics (embedded)	<ul style="list-style-type: none">▪ Abandoned objects▪ Intrusion▪ Sabotage▪ Wrong direction▪ Loitering▪ Object counting▪ Object removal <p>2 analytics functions can be activated simultaneously</p>
--	--

Event Triggers	<ul style="list-style-type: none">▪ External input▪ Analytics▪ Network failure detection▪ Periodical event▪ Manual trigger
----------------	--

Event Actions	<ul style="list-style-type: none">▪ External output activation▪ Video and audio recording to edge storage▪ File upload: FTP, network share and email▪ Notification: HTTP, FTP, email
---------------	---

General







Casing	Metal Housing
Camera Module Adjustment	3-Axis Gimbal (Pan/Tilt/Rotate)
Device Color	Metal body housing: RAL 9003 Logo color: Pantone 286C and Pantone Gray 6 Cu
Power	PoE+ IEEE802.3at, class 4, max 23.11 W AC 24 V, max 24.20 W max 39.60 VAPoE IEEE802.3af, class 0, max. 7.5 W Zero-Down-Time Power Source SwitchingPoE IEEE802.3af, class 0, max. 12.95 W 12 V DC, max. 15.59 W 24 V AC, max. 13.31 W (25.08 VA) Zero-Down-Time Power Source SwitchingPoE IEEE802.3af, class 0, max 11.67 W 12 V DC, max. 12.14 W 24 V AC, max. 11.99 W (20.02 VA) Zero-Down-Time Power Source SwitchingPoE IEEE802.3af, class 0, max 12.95 W 12 V DC max. 11.16 W
Connectors	RJ45, Alarm in x2, Alarm out x1, 12 VDC Terminal Block, 24 VAC Terminal Block, Audio in 3.5 mm Jack, Audio out 3.5 mm Jack, CVBS Connector COAX (75 Ohm) (CVBS output available with max. 2 activated streams, requires optional adapter cable 2Pin - COAX)
IR Illumination	Up to 40 m distance depending on scenery reflection
Video Storage	Support for microSD/microSDHC/microSDXC card, Support for recording to NAS, MOBOTIX MOVE NVR
Environmental Protection Class	IP66/IK10
Operating Temperature	-40 to 60 °C/-40 to 140 °F

Technical Specifications

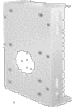
MOBOTIX 2MP Vandal Fixed Dome Analytics Camera

Cold Start Temperature	-30 °C/-22 °F
Relative Humidity	10 to 90 % non-condensing
Storage Conditions	-20 to 70 °C/-4 to 158 °F
Approvals	EMC: CE/FCC Safety: LVD Environmental: IP66, IK10
Dimensions	ø 133.8 x 117.4 mm
Weight	760 g

Accessories

Picture	Order Code	Description
	Mx-M-VD-W	Wall Mount set (2 pieces) for MOBOTIX MOVE Vandal Dome Cameras
	Mx-M-VD-P	Pole Mount (junction mount) for MOBOTIX MOVE Vandal Dome Cameras
	Mx-M-VD-C	Corner Mount for MOBOTIX MOVE Vandal Dome Cameras
	Mx-M-VD-IC	Ceiling Flush Mount for MOBOTIX MOVE Vandal Dome Cameras
	Mx-M-VD-DCT	Clear Replacement Bubble for MOBOTIX MOVE Vandal Dome Cameras
	Mx-M-VD-DCS	Tinted (smoked) Replacement Bubble for MOBOTIX MOVE Vandal Dome Cameras
	Mx-NPA-UPOE1A-60W	UPoE Network Power Injector 60 W

Dimensions

NOTE! Download the drilling template from the section or on the MOBOTIX website: www.mobotix.com > Support > Download Center > Marketing & Documentation > Drilling Templates.

CAUTION! Always print or copy at 100% of the original size!

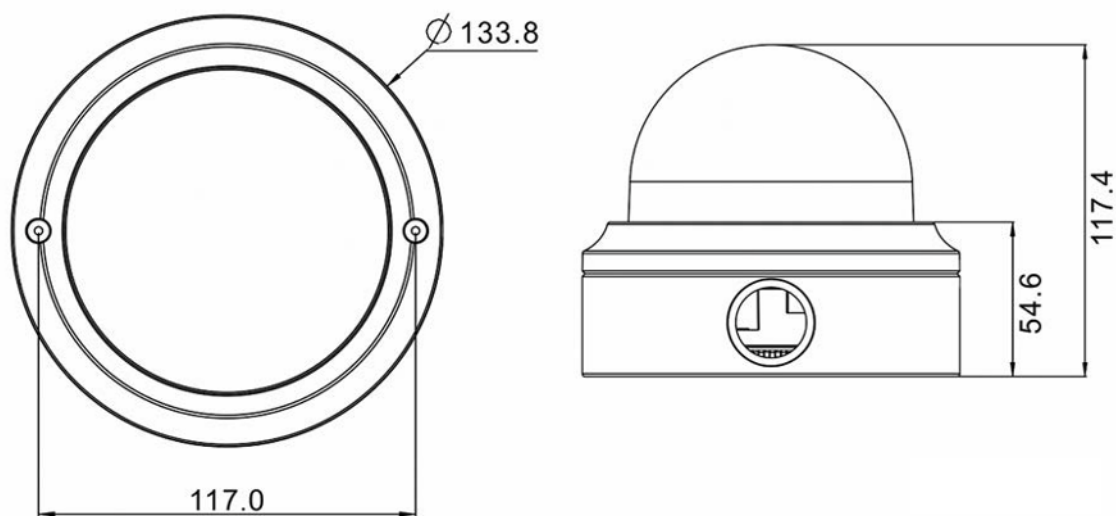

Fig. 1: 2MP Vandal Fixed Dome Analytics Camera: All measurements in mm

MOBOTIX

BeyondHumanVision

[EN_12/21](#)

MOBOTIX AG • Kaiserstrasse • D-67722 Langmeil • Tel.: +49 6302 9816-103 • sales@mobotix.com • www.mobotix.com

MOBOTIX is a trademark of MOBOTIX AG registered in the European Union, the U.S.A., and in other countries. Subject to change without notice. MOBOTIX do not assume any liability for technical or editorial errors or omissions contained herein. All rights reserved. © MOBOTIX AG 2020