



More Camera For Less. Guaranteed!

The M24M series from MOBOTIX offers extremely compact, cost-effective and exceptionally powerful allround cameras with the widest range of lenses, including panorama version. Fully equipped with IP66-certified housing and long-term internal storage on a MicroSD card.

M24M Allround L22



M24M Allround L11



M24M Allround CS-Vario



Latest PDF file:

www.mobotix.com > Support > Manuals

HiRes

3 Megapixel

2048 x 1536
Software zoom

Skyline

Format free

Each image format
freely definable

30 Frames/s

VGA (640 x 480)
30 F/s Mega

Virtual PTZ

Digital pan, tilt,
zoom

Backlight

Safe using CMOS
without mechanical iris

Internal DVR

Internal via Flash,
external via Network

Win/Lin/Mac

Recording

via Network on PC
up to 1 Terabyte

Microphone & speaker

Audio

bi-directional via IP,
variable framerates

SIP-Client with video

IP Telephony

Alarm notify,
cam remote control

VideoMotion

Multiple windows
precision pixel-based

-22 to +140 °F

Weatherproof

-30 to +60 °C, IP65,
no heating necessary

IEEE 802.3af

PoE

Network power
even in winter

Robust

No moving parts
fiber glass housing

MxCC/MxEasy

Licence free

Video-Management-
Software

HiRes Video Innovations

The German company MOBOTIX AG is known as the leading pioneer in network camera technology and its decentralized concept has made high-resolution video systems cost efficient.

MOBOTIX AG • D-67722 Langmeil • Tel: +49-6302-9816-103 • Fax: +49-6302-9816-190 • sales@mobotix.com

Enter your camera data here.

Camera Model: _____

Camera Name: _____

Factory IP Address: _____

Current IP Address: _____

DHCP: _____

Admin User Name: _____

Admin Password: _____

Default User
Name: **admin**
Password: **meinsm**



Note

MOBOTIX offers inexpensive seminars that include workshops and practical exercises: **Basic Seminar** three days, **Advanced Seminar** two days.

For more information, please visit www.mobotix.com.

CONTENTS

Foreword	6
The MOBOTIX Concept	8
MOBOTIX Hemispheric Technology	10
Superior Storage Solution	12
Added Security Value	14
Cost Benefits and Technical Advantages	16
1 INTRODUCTION	18
1.1 M24M Overview	18
1.2 M24M With Hemispheric Special L11 Lens	26
1.3 M24M: HiRes Allround Camera With Widest Range Of Lenses	32
1.4 General MOBOTIX Camera Functions	34
1.5 Lens Options, Hardware And Software Features	40
2 INSTALLATION	44
2.1 Preparing The Installation	44
2.1.1 Flexible Installation Using VarioFlex Mount	44
2.1.2 Mounting To A Ceiling Or Wall	46
2.1.3 Mounting Tips For The M24M With L11 Lens (180° Fisheye)	47
2.1.4 Optional: Mounting To A Pole (With Accessories)	49
2.1.5 Network Connection And Power Supply, UPS	50
2.1.6 Preparing The Camera Connections, Wall Outlets	51
2.1.7 Wiring, Fire Prevention, Lightning And Surge Protection	52
2.2 M24M-IT/Secure: Delivered Parts, Components, Dimensions	54
2.2.1 Delivered Parts And Camera Components	54
2.2.2 Camera Housing And Connectors	55
2.2.3 Dimensions (mm) For Wall Installation	58
2.2.4 Dimensions (mm) For Ceiling Installation	58
2.2.5 Dimensions (mm) Of Wall Mount	59
2.2.6 Drilling Template (mm) Wall And Ceiling Mount	59
2.3 Available M24M Accessories - Overview	60
2.4 Mounting The Camera With Wall Mount	64
2.4.1 Mounting Instructions	64
2.4.2 VarioFlex Wall Mount	64

2.4.3	Required Tools	66
2.4.4	Procedure	67
2.5	Mounting The Camera With Ceiling Mount	70
2.5.1	Mounting Instructions	70
2.5.2	VarioFlex Ceiling Mount	70
2.5.3	Required Tools	72
2.5.4	Procedure	73
2.6	Mounting The Camera With Pole Mount	76
2.6.1	Mounting Instructions	76
2.6.2	Pole Mount (MX-MH-SecureFlex-ESWS)	77
2.6.3	Procedure	79
2.7	Adjusting The Camera And Changing The Lens	82
2.7.1	Adjusting The Camera	82
2.7.2	Correcting The Image Horizon (For L11 Lens Only)	82
2.7.3	Changing The Lens	83
2.8	Replacing The MicroSD Card	84
2.8.1	Removing The MicroSD Card	84
2.8.2	Inserting The MicroSD Card	85
2.9	Network And Power Connection	86
2.9.1	Notes On Cable Lengths And Power Supply	86
2.9.2	PoE Variables	86
2.9.3	Power Supply Using A Switch	87
2.9.4	Power Supply When Connected Directly To A Computer	88
2.9.5	Power Supply (PoE IEEE 802.3af) Using Power Over Ethernet Products	88
2.9.6	Camera Startup Sequence	89
3	OPERATING THE CAMERA	90
3.1	Manual And Automatic Operation - Overview	90
3.1.1	Manually Using A Computer In The 10.x.x.x IP Address Range	91
3.1.2	Automatically Using MxControlCenter Or MxEasy	92
3.1.3	Automatically Using DHCP	93
3.2	First Images And The Most Important Settings	94
3.2.1	Manually Setting Up The Network Parameters In A Browser	94
3.2.2	First Images And The Most Important Settings In The Browser	96
3.2.3	First Images And Network Parameter Configuration In MxControlCenter	98
3.2.4	First Images And Network Parameter Configuration In MxEasy	103
3.2.5	Starting The Camera With An Automatic IP Address (DHCP)	108
3.2.6	Starting The Camera With The Factory IP Address	109

Contents

3.3	Virtual PTZ	110
3.4	Correction Of Lens Distortion (L22 Only)	112
3.5	Special Hemispheric Configuration In The Browser (L11 Only)	114
3.6	MicroSD Card Recording	120
3.6.1	Introduction	120
3.6.2	Formatting The Card	122
3.6.3	Activate Recording	123
3.6.4	Accessing Camera Data	124
3.6.5	Deactivating The Card Memory	124
3.6.6	Using A MicroSD Card In A Different MOBOTIX Camera	125
3.6.7	Limitations On Warranty When Using Flash Storage Devices	125
3.7	Full Image Storage	126
3.8	Configuration In The Browser	128
3.8.1	Overview	128
3.8.2	General Browser Settings	128
3.8.3	Additional Configuration Options	131
3.9	Additional Notes	132
3.9.1	Protecting The Camera Against Condensation	132
3.9.2	Password For The Administration Menu	133
3.9.3	Permanently Deactivating The Microphone	134
3.9.4	Starting The Camera With The Factory IP Address	134
3.9.5	Reset The Camera To Factory Settings	134
3.9.6	Activate Event Control And Motion Detection	134
3.9.7	Deactivate Text And Logo Options	135
3.9.8	Deactivating The Daily Automatic Camera Reboot	135
3.9.9	Browser	135
3.9.10	Cleaning The Camera And Lens	136
3.9.11	Safety Warnings	136
3.9.12	Additional Information	137

Notes and Copyright Information

The enclosed **Camera Software Manual** contains detailed information on the camera software. Download the latest version of this manual and the MxEasy and MxControlCenter manuals as PDF files from www.mobotix.com (Support > Manuals). **All rights reserved.** MOBOTIX, MxControlCenter, MxEasy, ExtIO and CamIO are internationally protected trademarks of MOBOTIX AG. Microsoft, Windows and Windows Server are registered trademarks of Microsoft Corporation. Apple, the Apple logo, Macintosh, OS X and Bonjour are trademarks of Apple Inc. Linux is a trademark of Linus Torvalds. All other brandnames mentioned herein may be trademarks or registered trademarks of the respective owners. Copyright © 1999-2009, Langmeil, Germany. Information subject to change without notice!

More information:
www.mobotix.com

FOREWORD

Dear MOBOTIX customer,



Congratulations on your decision to purchase an exceptionally versatile and innovative premium network camera "Made in Germany." The M24M Allround Camera features a **3.1 megapixel color sensor**, an **internal long-term memory with a maximum capacity of 32 GB** and the latest technology platform from MOBOTIX. This makes the M24M the first camera among the M models that can be fitted with the **MOBOTIX standard lenses (image angles from 15° to 90°)**, the **hemispheric L11 lens (image angle of 180°)** for high-resolution panorama images and with commercial **CS-mount lenses**.

This Camera Manual will give you an initial overview of the innovative MOBOTIX concept that is at the core of this technology. This includes all the information you need to unpack and install the camera (Chapter 2) and to view initial images on a PC (Chapter 3).

Please see the Software Camera Manual Part 2, included in the camera packaging, for information on how to work with the many camera functions, such as event control or image storage, for example.

If you would prefer to work with **MxEasy** or **MxControlCenter** instead of the browser-controlled MOBOTIX camera software, you can download these programs for free including a manual (PDF) from the MOBOTIX website:

www.mobotix.com/eng_US/Support/Software-Downloads

If you have any questions, our support and international sales staff are available at intl-support@mobotix.com from Monday to Friday, 8 a.m. to 6 p.m. (German time).

Thank you for choosing MOBOTIX products and services, we trust you will be impressed with the performance of your new M24M Allround Camera.

Security-Vision-Systems



© MOBOTIX AG • Security-Vision-Systems • Made in Germany

www.mobotix.com • sales@mobotix.com

M24M - High-resolution video surveillance with optimal weather protection (IP66)

MOBOTIX original Double Panorama image

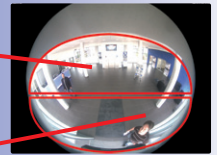

Original full image



High-Resolution Double Panorama



THE MOBOTIX CONCEPT

HiRes Video Innovations



The German company MOBOTIX AG is known as the leading pioneer in network camera technology since its founding in 1999, and its decentralized concept has made high-resolution video systems cost-efficient. Whether in embassies, airports, railway stations, ports, gas stations, hotels, or on highways - over one hundred thousand MOBOTIX video systems have been in operation on every continent for years.

Technology Leader Of Network Cameras

In a short time, MOBOTIX has gained the second place in Europe and the fourth place worldwide in terms of market share. MOBOTIX has been producing megapixel cameras exclusively for years and, in this area, ranks as the global market leader in high-resolution video systems with a market share of over 60%.

Why High-Resolution Systems?

The higher the resolution, the more accurate the detail in the image. With the old analog technology, a live image has no more than 0.4 megapixels, and a recorded image generally 0.1 megapixels (CIF). Yet, one MOBOTIX camera with 3.1 megapixels records around 30 times more detail. This means that greater image areas, including 360° panoramas, are possible, while still reducing the number of cameras, and thereby also the costs. For example, four lanes of a gas station may be recorded with a single MOBOTIX camera, instead of the four standard cameras normally necessary for such a task.

Disadvantages Of The Old Centralized Solution

Usually, cameras only supply images, while processing and recording take place later on a central PC using video management software. This traditional centralized structure has many limitations, since it requires high network bandwidth and the PC processing power is insufficient when using several cameras. An HDTV MPEG-4 film already puts considerable strain on a PC, how can it be expected to process dozens of high-resolution live cameras? Traditional centralized systems are therefore less suitable and more costly than high-resolution systems due to the high number of PCs required.

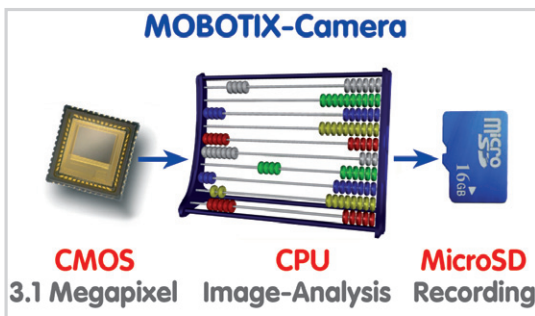

The Decentralized MOBOTIX Concept

Unlike other systems, with the decentralized MOBOTIX concept a high-speed computer and, if requested, digital memory (MicroSD/SD card) is built into every camera for long-term recording. The PC now serves purely for viewing, not for analysis or recording. As a result, MOBOTIX cameras can record in response to an event, even without the PC being switched on, and digitally store the videos with sound.

The Benefits

MOBOTIX video solutions therefore require significantly:

- **fewer cameras** due to the more accurate detail of panoramic images with megapixel technology,
- **fewer PCs/DVRs**, because around 40 cameras can store high-resolution videos with sound efficiently on a single PC, or no PC at all when recording in the camera using digital memory (USB, MicroSD/SD card),
- **lower network bandwidth**, because everything is processed in the camera itself and the high-resolution images therefore do not have to be constantly transported for analysis.

Robust And Low-Maintenance

MOBOTIX cameras have no mechanical motors for lenses or for movement. Without any moving parts, they are therefore so robust that maintenance is reduced to a minimum. The unique temperature range from -30°C to +60°C (-22°F to +140°F) is achieved without heating or a fan at approximately 4 watts. Since no PC hard drive is necessary for recording, there are no parts that wear out in the entire video system.

Software Included - For Life

There are no software or licensing costs with MOBOTIX because the software is always supplied with the camera for an unlimited number of cameras and users. The software package supplied with the camera also includes professional control room software similar to those used in soccer stadiums, for example. Updates are supplied free of charge on the website. The system price for a weatherproof camera, including lens, query software, and day-to-day recording on the MicroSD/SD card, is under 1,000 euro.



MOBOTIX HEMISPHERIC TECHNOLOGY (M24M-SEC-D11)

Perfect Room Overview

An entire room can be effectively monitored with innovative MOBOTIX Hemispheric Technology. For instance, one single hemispheric camera replaces the time-consuming and expensive installation of several standard cameras. The first of its kind in the world, this camera is evidence of the MOBOTIX commitment to innovation as the global leader in megapixel video security systems.

High-Resolution 180° Panorama

When several cameras are monitoring a single room, it is difficult to understand the room layout in its single view. This makes it hard to comprehend the overall setting. The new panorama function of the M24M delivers a widescreen image of a high-resolution 180° allround view. High image quality is achieved through the use of a 3.1 megapixel sensor and the new hemispheric lens.



M24M with special L11 lens and hemispheric technology

Original MOBOTIX image; Wall-mounted at a height of 2.3 m in a bank

Virtual PTZ (vPTZ) - Without Motor

The M24M also zooms in on detail. The image of the Hemispheric camera can be continuously enlarged and any image section examined using a joystick, for example. Thus you have a mechanical PTZ-camera without maintenance or wear and tear. While zooming into a section in the live image, a full image can be stored in the recording for later analysis. No PTZ-camera in the world that operates with a motor can do that!



vPTZ control, also using a USB joystick

One Camera, More Views

The surround function of the M24M (ceiling mounted) immediately replaces four conventional cameras and shows four different directions simultaneously in quad view on a monitor. Virtual PTZ is available for each of the four views. Together with the 180° panorama the M24M can deliver two more views simultaneously, making it possible to see the overview and to focus on two scenes at the same time (Display Mode "Panorama Focus").

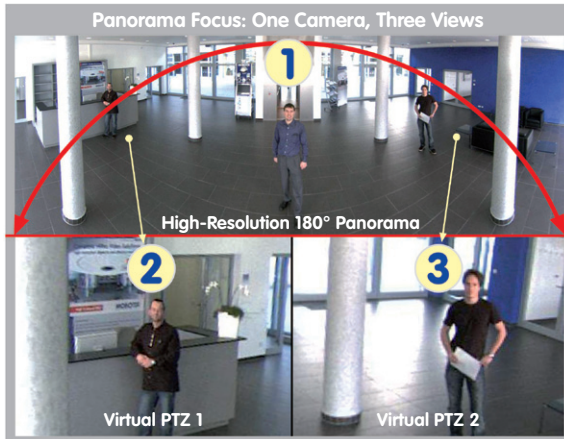

Panorama Focus: Original MOBOTIX image

Highly User-Friendly

The full image from a hemispheric lens (Fisheye) is difficult to analyze. MOBOTIX solves this problem by perfectly straightening the uneven lines in the live image using the camera software. Since the image distortion correction of the hemispheric view and the generating of the panoramic view take place in the camera itself, no additional load is placed on the viewer PC, unlike a "standard" camera. Thus, displaying a large number of panoramic cameras simultaneously on a single PC is possible.

Highly Efficient Image Transferring

While other camera systems always transfer the full images via the network for further analysis, a MOBOTIX camera sends only the relevant image sections. Therefore, a Q24M panorama image needs only about 1/6 of the original data volume or bandwidth. This means up to six times more MOBOTIX cameras can transfer images over a network compared to "standard" cameras.

Internal DVR With 32 GB

The M24M stores high-resolution video with sound directly on the integrated Flash memory without using an external recording device or PC, therefore using no additional network load. Old recordings can be overwritten automatically or deleted after a predefined period. The storage capacity is sufficient for around 400,000 panorama images or 33 hours of film (32 GB MicroSD).

SUPERIOR STORAGE SOLUTION

The Market Demands Better Image Quality

When it comes to future-proof video surveillance systems, **it is not a matter of analog or digital but whether it is high-resolution or not.** It is important to note that only HiRes video with decentralized network camera technology can be implemented at a much lower cost than any other type of video surveillance system.

Central Storage As A Bottleneck

These days, video data is normally pre-processed and stored centrally on a PC or DVR using video management software. Video and audio streams from all installed cameras are directed to this central device. This system is comparable to a highway at rush hour: the more cameras there are, the faster a data jam on the PC or DVR occurs. This means that despite HiRes cameras, the data is generally not stored in high-resolution format.

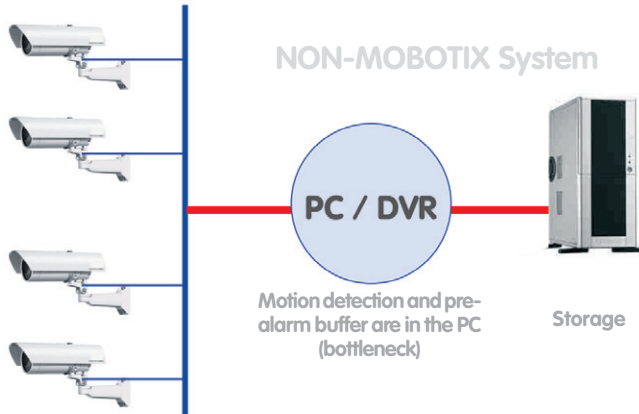

Central PC is a bottleneck and a risk for the total system

MOBOTIX Stores HiRes Cost Efficiently

MOBOTIX solves the PC storage bottleneck problem using a unique and yet amazingly effective method - through the camera itself. High-resolution video with lip synchronized sound is saved either remotely over the network or locally on flash memory devices (commercial SD or CF cards, USB memory).

Flash memory is a sophisticated form of semiconductor memory without mechanical moving parts and represents the storage medium of the future thanks to its reliability, ease of use and low cost.



Software and storage integrated in MOBOTIX cameras

MOBOTIX Saves To Flash

- No PC/network is required for continuous operations and there is no network load
- USB flash media can be connected directly to the camera (instead of internal SD/MicroSD/CF card); no network is necessary
- Greater reliability (no hard drive)
- Ring buffer: Old images can be overwritten automatically or automatically deleted after a specified period of time

MOBOTIX Stores Data Reliably

The MOBOTIX Flash file system (MxFFS) prevents unauthorized persons from reading or transferring the internally stored data, even if the card is stolen.

MOBOTIX Only Saves What Is Necessary

The MOBOTIX system includes three important additional options that allow more data to be stored for a longer time:

- Only the relevant image sections are stored instead of the entire image (for example, sky or ceiling is removed)
- Video recording only begins when relevant events occur (such as movement in the image)
- Temporarily increased frame rate during continuous recording of events

By connecting external memory over the network (NAS), the system can be expanded without limitations, even while it is running.

MOBOTIX Data Storage

- **Inside the camera** - one MicroSD card is enough to record all day long, making central data storage devices or PCs unnecessary
- In **USB storage** (connection via USB cable) data storage without mechanical moving parts or network load (greater protection against data theft)
- A **file server (NAS)** can store around ten times more data from MOBOTIX HiRes cameras than usual because they use a memory organization internally

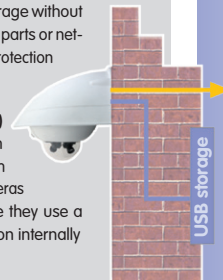

ADDED SECURITY VALUE



Robust, Low-Maintenance Technology

The real added value of MOBOTIX products is reflected in characteristics such as enhanced functionality, **long life and robustness**. In general, MOBOTIX cameras have no moving parts. This makes the cameras very resistant to wear and tear, and reduces both maintenance costs and power consumption.

Alarm Management And Forwarding

Integrated sensors enable MOBOTIX cameras to recognize when an event has occurred. If desired, the cameras will respond immediately with an alarm sound and will establish a direct video and audio connection to a control room.



Absolute Data Security

The security barriers that are built into the camera are extremely secure. The camera images are only accessible to authorized persons and are encrypted via SSL when they are transferred over the network.

Notification Of Failure

MOBOTIX cameras will automatically report any impairment or failure. This ensures maximum reliability and readiness for use.

Subsequent Searches

Events rarely confine themselves to just one spot. So even when you are looking at an enlarged detail in live mode, it is always the full image that is recorded. And in this full image, any section can always be enlarged later or whenever necessary.

Floor plan and camera view in MxControlCenter (free control center software from MOBOTIX)

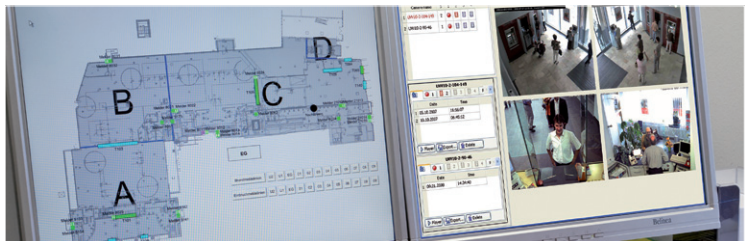

Sound Increases The Chance Of Detection

In the event of an alarm, MOBOTIX cameras can turn on their built-in microphones and record lip-synchronous sound. They are therefore an even greater help in analyzing a situation and easing clarification. In addition, the video system can be used for bidirectional communication via a loudspeaker/microphone.

No Problems With Backlighting

MOBOTIX cameras are not adversely affected by the glare from direct sunlight. They deliver meaningful, detailed images all the time because the camera software supports easy programming of independent **exposure windows** to cope with specific situations. This makes them ideal for rooms with large glass fronts.



Placing the exposure window in the lower image area (left image) delivers less optimum results compared to moving three individual exposure windows up toward the windows (right image)

Anti-Vandalism Dome Cameras

In critical environments or for outdoor use, it is often best to choose the optional **vandalism-protected** MOBOTIX cameras. Their steel housing resists even the hardest attacks, and the cameras will deliver a perfect image of the attackers.



D24M with Vandalism Set



Q24M with Vandalism Set

THE MOST IMPORTANT COST BENEFITS

- 1 Increased resolution reduces amount of cameras needed**
1536-line, high-resolution sensors give a better overview and allow monitoring an entire room with just one camera from the corner
- 2 Reduced installation costs at any distance**
Standard Ethernet connection enables the use of use of common network components such as fiber, copper and wireless (WLAN)
- 3 Intelligent recording technology reduces required storage**
Decentralized recording technology in the camera software puts less strain on PCs and reduces the amount of storage PCs (DVRs) by 10 times
- 4 Event-controlled image rate minimizes storage costs**
Event-driven, automatically adjusted recording frame rate based on event or sensor action reduces amount of data and storage costs
- 5 No additional power and no heating required**
Anti-fogging without heating allows usage of standard PoE technology to power the system via network and saves costs of power cabling
- 6 Backup power requirement reduced by 8 times**
Low power consumption, approx. 4 watts, enables year-round (no heating required) PoE with one centralized UPS from installation room via network
- 7 Robust and practically maintenance free**
Fiberglass-reinforced composite housing with built-in cable protection and no mechanical moving parts (no auto iris) guarantees longevity
- 8 No software and no licence costs**
Control and recording software is integrated in the camera and is free of charge; new functions are available via free software downloads
- 9 Unlimited scalability and high return of investment**
While in use, more cameras and storage can be added at any time; image format, frame rate & recording parameters can be camera specific
- 10 Additional functions and other extras included**
Audio support, lens, wall mount and weatherproof housing [-30°C... +60°C (-22°F... +140°F)] are included; microphone & speaker available in certain models

THE MOST IMPORTANT TECHNICAL ADVANTAGES

Progressive-scan instead of half-frame blur

Megapixel sensor and image processing inside camera with digital white balance generates sharp and true color images at every scale

1

Sun and backlight compensation

CMOS-sensor without auto iris, digital contrast enhancement and configurable exposure measurement zones guarantee optimal exposure control

2

Dual camera technology: 2-in-1

Two possible camera views with picture-in-picture technology or 180° panoramic view; one Dual-Fixdome camera with 2.5 megapixel is enough

3

Long-term, high-performance Terabyte recording included

Event detection and ring buffer recording by the camera itself allow recording of 40 smooth video streams on a single PC (1200 VGA images/s)

4

Simultaneous recording, event search and live viewing

Live video for multiple users, recording and event search simultaneously possible in seconds from anywhere in the world via network

5

Very low network load

Efficient MxPEG video codec, motion detection based recording and video buffering inside camera guarantee a very low network load

6

Bridging of recording during network failures

Internal camera ring buffer bridges network failures and bandwidth fluctuations of wireless links (WLAN/UMTS) for several minutes

7

Day & night maintenance free

Unique Day/Night camera technology without moving parts guarantees extreme light sensitivity and ensures long-term reliability

8

Audio and SIP telephony

Lip-synchronized audio (live & recording); each camera is a video IP telephone based on SIP standard with automatic alarm call and remote control

9

MxControlCenter included

Dual screen technology with building plans, free camera positioning, event search, image processing, lens distortion correction and PTZ support

10

1 INTRODUCTION

1.1 M24M Overview



The World's First HemisphericReady Allround Camera

With the M24M series, MOBOTIX offers extremely compact, versatile and cost-effective allround cameras with an integrated video sensor, lip-synchronous audio transmission and long-term internal storage on a MicroSD card (4 GB card as standard). Since the M24M is equipped with the latest MOBOTIX technology platform, it is the first HemisphericReady camera in the M series – **capable of accepting the 11mm lens to give high-resolution panoramic images.**

High Frame Rates Of Up To 30 fps

Like all other MOBOTIX cameras, the M24M models can generate live video streams with high frame rates and up to 3.1 megapixels image resolution (QXGA with 2048 x 1536 pixels). Up to 30 fps are generated at a megapixel resolution of 1280 x 960 pixels. Even at 3.1 megapixels, the camera will still generate up to 20 fps!

A Master Of Adaptability

The M24M models are accompanied by an extensive range of easily replaceable and interchangeable lenses and a robust lens protector made of scratchproof special-purpose plastic or glass. Application-optimized options for installation on walls, ceilings and poles, for supplying power, or expanding the functions of the camera are also available. Furthermore, MOBOTIX customers can take advantage of **MxEasy** or the professional control center software **MxControlCenter** free of charge and with an unlimited user and camera license. If required, an M24M camera can even be upgraded to function as a powerful intercom system by adding the MOBOTIX **ExtIO module**.



MOBOTIX ExtIO
(Function Extension)

Robust And Practically Maintenance Free

Thanks to their low power consumption of 3 watts and the total absence of mechanical moving parts, M24M cameras feature the highest operating temperature range (**-30°C to +60°C, or -22°F to 140°F**). Since MOBOTIX cameras neither fog up nor require heating, power can be supplied via the network cabling according to the **PoE standard IEEE 802.3af**. M24M IT and Secure models are completely dust-proof and resistant to water jets (IP66). The M24M Wall and Ceiling Mount supplied as standard makes the camera ideally suited for outdoor use and for installation over flush-mounted sockets so that the **cabling remains perfectly concealed**.

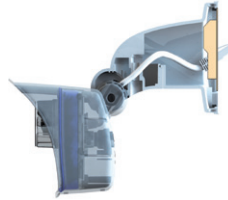

VarioFlex wall mount with concealed cabling completely covers flush-mounted sockets

High-Resolution Sees More And Costs Less

One M24M camera equipped with a hemispheric or standard wide angle lens is usually all that is required to monitor either an entire room or the four lanes of a gas station. The high degree of image detail not only reduces the number of required cameras, but also minimizes system costs by reducing the wiring complexity, emergency power requirements and number of recording devices required. All M24M cameras feature direct recording to integrated MicroSD cards or external USB drives and can therefore be used in standalone operation with no additional network load.

One Camera For Four Gas Station Lanes – Long-Term Recording Without Additional Devices



Universal Application From The Vacation Home To The Airport

MOBOTIX M24M cameras are suitable for use in large-scale facilities, such as airports, given their unlimited scalability and high performance. However, they are equally suitable for use in small commercial or private buildings thanks to their integrated event, storage, alarm and telephony functions. In addition, MOBOTIX recommends the M24M in combination with a **hemispheric L11 lens as a superb, inspiring panorama webcam**.

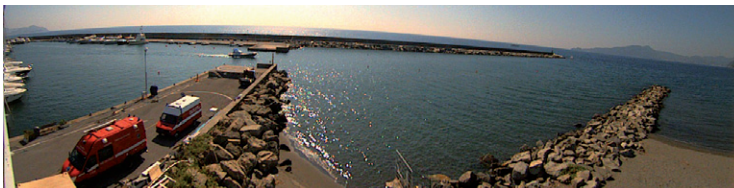

MOBOTIX original 180° Panorama image (L11 lens)

The Right Lens For Every Application

No MOBOTIX camera has ever had so many lens options! All **five MOBOTIX standard lenses, from the 15° Tele right through to the 90° Super Wide Angle**, are offered with the M24M.

MOBOTIX original 90°
Super Wide Angle image



Furthermore, the M24M is the first HemisphericReady camera from the M series and can also be equipped with the **hemispheric L11 lens (image angle of 180°)**.

MOBOTIX original
180° Panorama
image (L11 lens)



The **M24M-Sec-CSVario** is an M24M model that is shipped with a CS mount and a compact **L24-L54 1/2" Vario lens**. To protect the lens against the weather, this model comes with a longer lens cover with an integrated glass pane which includes threads for an external filter. This cover is suitable for lenses with a maximum diameter of 36 mm and a maximum length of 43 mm. Because of the image sensor's size of 1/2", CS and C mount lenses for 1/2" sensors or larger that are designed for megapixel image sensors can be used. In comparison with MOBOTIX fixed lenses, Vario lenses are less robust and less reliable in the long run. For this reason, Vario lenses are typically used in applications where recording conditions change frequently, for example, intermittent surveillance of construction sites.

You can change all M24M lenses on site whenever necessary (except the hemispheric L11 lens). Each lens is secured by a lock ring. The ordered lens is factory-aligned and quality-tested in the camera, which makes on-site camera focusing unnecessary in most cases. Each M24M is available for delivery with a lens of your choosing or no lens at all. The image area captured by the camera varies depending on the selected lens (see Section 1.5). With a **Super Wide Angle lens (L22 with 90°)**, for example, almost an entire room can be recorded from just one corner. A **L135 Tele lens** enables an M24M with a high-resolution 3.1 megapixel sensor to clearly record a license plate number, for example, from a distance of approximately 75 meters.



With an M24M equipped with an L11 or L22 lens, the distorted image can be corrected by the software

MOBOTIX original image (L135 Tele lens)

Or even the serial number of a bill from a distance of two meters.

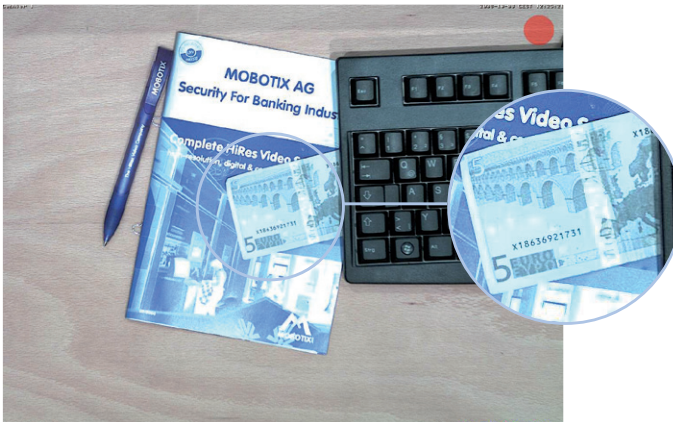

MOBOTIX original image (L135 Tele lens)

Virtual PTZ (vPTZ) – Panning, Tilting, And Zooming With No Motor

The M24M can also zoom in on detail as well. This vPTZ function (virtual Pan, Tilt, Zoom) is a standard feature in the integrated M24M camera software. The image from the hemispheric camera can be enlarged using, for example, the mouse wheel, a joystick or a software-controlled PTZ panel and you can "move" the view to any section of the image. This provides the features of a mechanical PTZ camera without the disadvantages of maintenance and wear.



Quick and easy navigation with a USB joystick

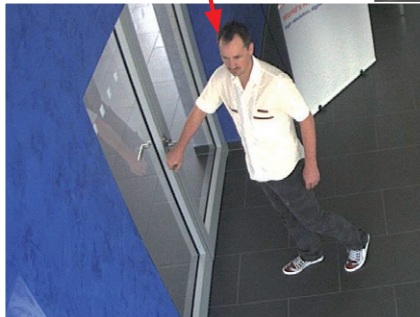
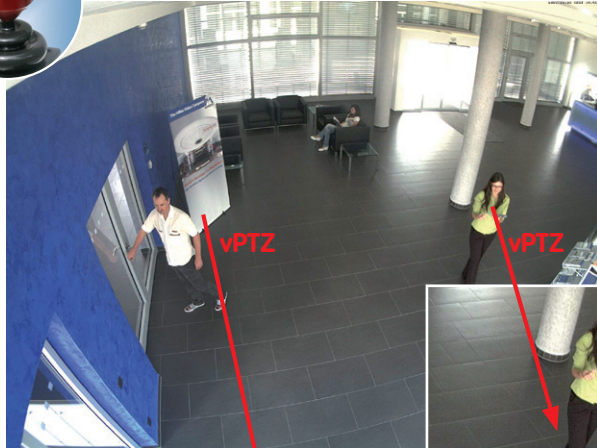

Simultaneous Zoomed Live Image And Full Image Recording

All conventional, motorized PTZ cameras only store the image that is currently viewed as the live image (**live image recording**). This has one serious disadvantage as the recording can only show what has happened in the "visible" portion of the image; the rest is lost and cannot be examined later on. For this reason, MOBOTIX has added the new **full image recording** feature to the M24M. This will not store the currently viewed image that reflects the pan/tilt position and the zoom setting chosen by the user, but the full sensor image – without vPTZ settings. When examining the recorded images at a later date, the vPTZ features again come into play, as they allow the visible image to be zoomed and use the pan/tilt features to examine every corner of the recorded full image.

Example:The two people indicated by the red circles in the middle image would not have been recorded by a regular PTZ camera. The full image recording of the M24M allows you to determine, for example, the exact time at which these people entered the image area recorded by the camera. A browser, MxControlCenter and MxEasy can be used to examine the recorded sequences.

Integrated vPTZ functions allow the complete stored full image to be analyzed at a later point in time (in MxEasy and MxControlCenter)

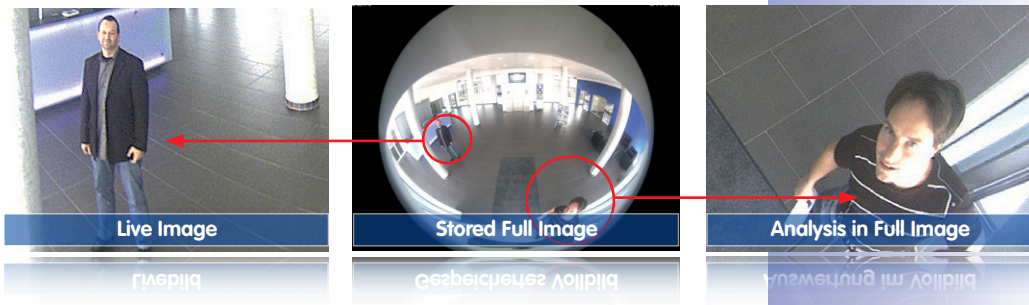

Internal DVR

The M24M features direct recording to integrated MicroSD cards, which makes the camera fully independent of any external storage media, even for longer periods of time. The camera internally stores high-resolution video, without requiring an external recording device or PC and therefore without overloading the network whatsoever. Old recordings may be overwritten automatically or automatically deleted after a specified period of time. A 32 GB MicroSD card, for example, allows the camera to store more than half a million event images in VGA format (640 x 480). For security reasons, the camera can even encrypt the stored data (available in future software versions). Power failures are not an issue, as the video and image sequences remain safely stored on the MicroSD card. Access to stored video sequences is possible at any time from the camera user interface in the browser, MxControlCenter or MxEasy. If you would like to archive sequences, you can export the required data to a PC or USB stick for evidence purposes, for example.



Model Versions

M24M models with L11 and CS Vario lenses are only available as Secure models (see Section 1.5 for more details)

The M24M is available in the **Secure, IT or Basic models**, which all come with different features. The M24M is shipped with **either a color or black and white image sensor (Day/Night)** and with an **L22 Super Wide Angle lens (horizontal angle of 90°)** as standard. Furthermore, **five further factory lenses with image angles of 15°, 31°, 45°, 60° and 180°** as well as a version with a **CS Vario lens** are available upon request. Every M24M is provided with a pre-formatted and installed 4 GB MicroSD card and a VarioFlex mount for fast and easy installation.

Due to the extreme optical distortion of the M24M with the **L11 fisheye lens**, special requirements must be met with regard to the alignment of the hardware and software. For this reason, interchangeable lenses cannot be used with this version. The camera's lens is extensively and precisely fine-tuned in the factory and should not be adjusted.





1.2 M24M With Hemispheric Special L11 Lens

Equipped with the 180° L11 lens, an entire room can be ideally monitored using just one M24M, which replaces the time-consuming and expensive installation of several standard cameras. The overview image provided by a single M24M, which may be personalized in a number of ways according to specific user requirements, not only reduces the number of required cameras, but also minimizes the system costs by reducing the wiring complexity, emergency power requirements and number of recording devices required.

L11 Lens: High-Resolution 180° Panorama

When several cameras are monitoring a single room, it is difficult to understand the room layout due to the different viewing directions of each individual camera. This makes it hard to comprehend the overall setting. The new panorama function of the M24M with the L11 lens delivers a widescreen, corrected image of a high-resolution 180° allround view. High image quality is achieved through the use of a 3.1 megapixel color sensor and the new hemispheric lens of the M24M.

With approximately 0.6 megapixels (1280 x 480 pixels), an M24M panorama image only requires a fraction of the original data volume or bandwidth of a 3.1 megapixel full image (1280 x 1536 pixels).

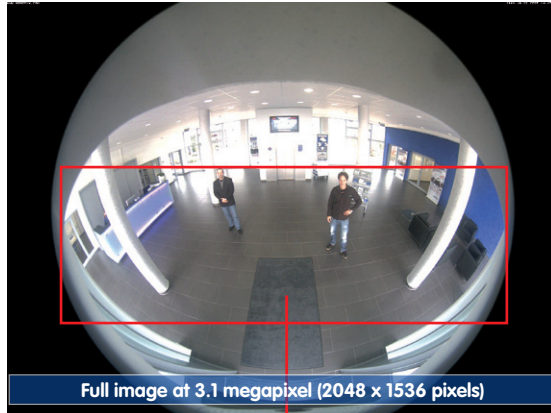

Corrected image after
panorama correction

Economical bandwidth
usage due to smaller,
camera-corrected
images (no loss of
image information)

The factory default setting of an M24M with an L11 lens is a **high-resolution 180° panorama image**, in which parts of the protective cover are still visible in the upper right and left corners of the image.



Original full image



Optimizing The M24M Panorama Image

In order to hide the protective cover in the panorama image, all that is often required is the "panorama correction" function, which has already been integrated into the camera software (controlling the camera via a web browser). Tilted vertical lines (if the camera is mounted at an angle) may be optically straightened to the image edges using this function (see Section 3.5). A welcome side effect of this is that the protective cover disappears from the image.



180° panorama image after the panorama correction function has been applied

If this measure does not work in some special cases (camera tilt of approximately 0°), the protective cover can be removed from the image by zooming and, if necessary, by using the purely software-based downward panning function. The displayed image section or the panorama, as the case may be, is reduced slightly but the image details are enlarged as a result of zooming.

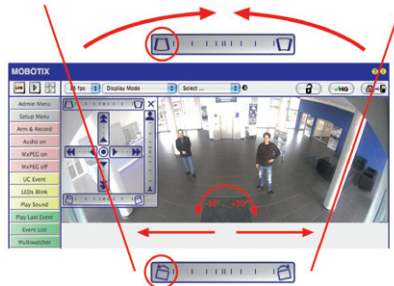

Section 3.5 provides more details and information on how the panorama and horizon correction works (correct distortion in the image and position horizontally)

L11 Lens: Panorama Focus – One Camera, Three Views

Maximum room overview while simultaneously viewing detail in a single image: the M24M is capable of providing two more views simultaneously with the 180° panorama, allowing you to focus on two scenes in parallel ("Panorama Focus" display mode).

MOBOTIX original
Panorama Focus image



Original full image

**L11 Lens: Double Panorama For A Simultaneous View In Two Directions**

The "Double Panorama" display mode provides a panorama image of both halves of the area captured by the full image. Using the vPTZ functions, the panorama images can be changed as desired. The example here shows an overview panorama of the entire room, as well as the entrance, which would have otherwise no longer been visible in the panorama – a superb overview for the user.

MOBOTIX original
Double Panorama image



Original full image



L11 Lens: Surround View (Quad View)

The M24M's "Surround" display mode replaces four cameras all at once and simultaneously delivers four different directions "at a glance." If the camera is installed in the ceiling and is looking straight down, all four cardinal directions can be displayed, for example.

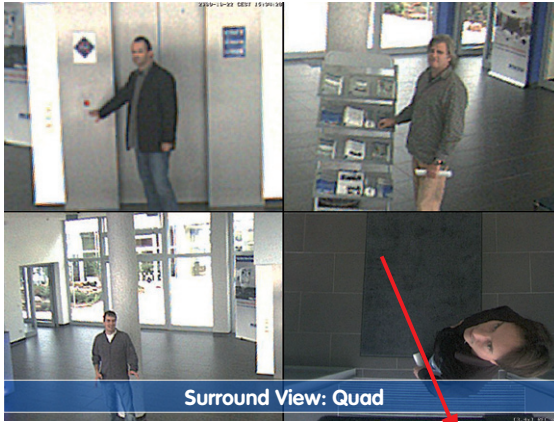

Each of the four views features a software-controlled pan/tilt/zoom function (virtual PTZ), allowing it to be customized as necessary. In order to facilitate camera operation, the M24M can store, in addition to the preset standard views, a total of **256 user-defined camera views using the vPTZ function**, which can easily be brought up using joystick keys or softbuttons. Besides being able to manually bring up specific camera views, the camera can also show them automatically. It does so by moving through the standard views or by showing the first 16 saved camera views (**one after the other like in a slide show**).

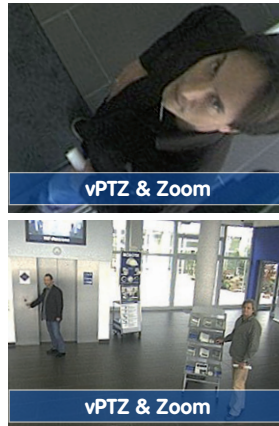

Original M24M image:
Each of the four views can be individually modified



Original full image

L11 Lens: Full Image And Normal View

In addition to Panorama, Double Panorama, Panorama Focus and Surround views, the M24M image may be displayed on a monitor as the original fisheye version ("Full Image" display mode) or as the camera-corrected image section ("Normal" display mode). Switching to one of the other display modes described is possible at any time within seconds.

Original MOBOTIX
full image



Original MOBOTIX image
Corrected and
zoomed full image



L11 Lens: Factory Settings Of The Standard Views For A Wall Installation

In order to fully exploit the potential of the M24M in the desired view, it may be necessary to adjust the factory settings using the integrated vPTZ function. We have summarized the factory default settings of a wall-mounted M24M with an L11 lens (with a downward tilt of approx. 15°, 2.7 m high) here in order to give you a good idea of what to expect once the camera has been installed.



Full image (left) and "Panorama" display mode (right)



Full image (left) and "Double Panorama" display mode (right)

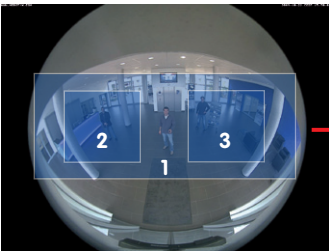

Full image (left) and "Panorama Focus" display mode (right)



Full image (left) and "Surround" display mode (right)



1.3 M24M: HiRes Allround Camera With Widest Range Of Lenses

The high-resolution Allround M24M camera is the more powerful successor to the M22M and comes with a new microprocessor and a modified system platform. The result is more than twice the processing power, which enables smooth video frame rates, even in the high-resolution panorama display combined with the now available hemispheric L11 lens.

Double The Frame Rates Of The M22M

Even 3.1 megapixel camera images may be transferred at a rate of up to 20 frames per second and megapixel images at up to **30 images per second**.

Internal DVR With 4 GB MicroSD Card

Every M24M is delivered with a high-quality, factory-installed **4 GB MicroSD card** (internal DVR) as a standard feature – sufficient for around 50,000 panorama images or ten hours of HiRes continuous recording including audio (4 fps).

New, Waterproof Connections To The Camera

The network cable, the Mini USB cable and the MxBus for IO extensions are easily connected using waterproof connectors with bayonet catch in the back of the camera. The standard weatherproof housing complies with the strict **IP66 standard**.

New VarioFlex Wall And Ceiling Mount

Simple and flexible installation using the extremely robust VarioFlex Mount (supplied as standard) – including concealed cabling and an extra wide positional range for even more installation options.

Adjustable PoE Classes, 1 To 3

The **PoE class** of the camera may be raised or lowered from the default value of 2 to 1 or 3 from the camera software in order to precisely adjust the functionality of the camera, its accessories and the PoE switch.

Only 3 Watt Power Consumption

Despite the use of a more powerful processor, the power consumption of the M24M is maintained at an extremely low level of only **3 watts**.

New Audio Functionalities

Microphone and speakers are integrated and, thanks to the **new HiFi audio component**, the audio quality is once again improved and echoes during hands-free operation can now be eliminated. If data protection requires it, microphone and audio recording can be irreversibly switched off by securing the hardware.



1.4 General MOBOTIX Camera Functions

Like all MOBOTIX cameras, the M24M line has a variety of software functions: from motion detection and long-term storage right through to alarm notification via video IP telephony. Unlike in camera systems from other manufacturers, it is not necessary to buy and install additional software on the computer. It is possible to use a web browser, however, you can also download the free MxControlCenter or MxEasy from the MOBOTIX website, which allow quick displaying of multiple cameras on one monitor, alarm switching with audio or an easy event search.

Camera vPTZ functions can be controlled with a mouse or joystick

Using a joystick: Internet Explorer with activated MxPEG ActiveX plugin, MxControlCenter or MxEasy required

MxControlCenter and MxEasy can be downloaded free of charge at www.mobotix.com

vPTZ: Virtual Pan/Tilt/Zoom Features

While MxControlCenter has been providing virtual PTZ features for some time now, these features are now available directly in the MOBOTIX camera. This means that you can continuously zoom into or out of the live image using either the mouse wheel or a joystick. When storing images or video sequences, you can choose to store either the visible image area of the live image or the full sensor image (full image storage). This also allows you to examine parts of an image or video that had not been visible in the live image section on display at the time of the recording.

Automatic Image Correction (Only With L22 Or L11 Lenses)

Another problem familiar from the field of photography are the distortions that result from using wide angle lenses. Straight lines near the image borders are curved. The integrated distortion correction features of the camera (and of MxControlCenter) allow the curve of various lenses to be corrected using software functions.

Live Video With Up To 30 fps, Including Audio

MOBOTIX cameras deliver smooth live video with lip-synchronous audio, yet they keep network load to a minimum. Some analog systems may also be able to deliver this, but the recording quality is so much higher with MOBOTIX since the cameras efficiently store the high, live image resolution and frame rate without compromising image quality. MOBOTIX technology thus provides for continuous recording of simultaneous video from 30 cameras at 30 frames per second each, including audio, all on one standard PC.

Very Low Network Load

MOBOTIX's patent-pending **streaming format MxPEG** enables fast live video with audio at extremely low network load (1 to 2 Mbps). Since the MOBOTIX camera itself detects movements in the image (and not the computer), video sequences are only transmitted when they are being stored externally.

Voice Over IP

Moreover, MxPEG provides for lip-synchronous live audio and two-way communication between the camera and a computer. Room surveillance is possible using a browser (Internet Explorer), MxControlCenter, or MxEasy. Customized alarm notification on your mobile phone or via Internet telephony is just as easy as event-controlled voice messages directly from the camera.

Internet Telephony (SIP) And Video SIP

Video SIP allows audio/video connections to be established to the camera using Windows Messenger or similar applications (for example, CounterPath X-Lite/Eyeball). This feature also allows the camera to be remote controlled using the phone keys and the camera itself can place phone calls in case of alarms.

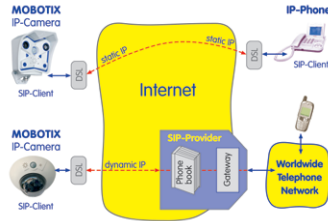

Long-Term Storage On File Servers Included

MOBOTIX cameras have an integrated long-term storage system for Linux, Windows, and Mac OS X computers. Every camera manages its own ring buffer storage to a shared folder. Thanks to this decentralized approach, 30 live cameras can store images of up to 30 frames per second each, including audio, on a single computer.

Internal DVR: Storage On MicroSD And CF Cards

MOBOTIX cameras support direct storage on an internal MicroSD/SD/CF card (Basic models excluded). By using this integrated flash card DVR, the camera is able to offer the following additional applications:

- Standalone use of the camera without a file server by recording to the MicroSD card
- High-security application with recording on a file server or NAS/SAN in which the SD card serves as storage buffer. It can thus bridge longer network or file server failures without losing any video sequences (supported in a future software version).
- Event downloads from the MicroSD card for evaluation of the recorded sequences on a computer

	Internal DVR	External USB Storage	Comments on USB Storage
M12	optional	optional	Adapter cable required
D12	optional	optional	Adapter cable required
V12	optional	-	-
M24M	included (upon delivery)	optional	Device can be connected directly
D24M	included (upon delivery)	optional	Adapter cable required
Q24M	included (upon delivery)	optional	Adapter cable required

Internal DVR is either an option during order placement (for example, M12 R16) or upgradeable later with an SD card

A 4 GB MicroSD card is included with the M24M

Event And Time-Controlled

Just like triggering event-controlled recording upon detecting movements in the image, the camera can also record when the volume detected by the microphone exceeds a certain trigger value. Using scheduled daily recording, time tasks can start or stop video recording, upload images to a website, or send e-mails with video/audio clips. Vacation times and holidays can be programmed.

Remote Alerting

In case of an alarm, MOBOTIX cameras can automatically pop up windows or activate other functions at a remote security control center. The cameras can use network/wi-fi, GSM/GPRS/UMTS (3G), or Internet connections for this purpose.

Integrated Power Over Ethernet

Power is supplied as Power over Ethernet via the network cabling using the MOBOTIX NPA-PoE-Set or from a PoE-compatible switch (both according to the IEEE 802.3af PoE standard).

No heating required
- PoE is no problem,
even in winter

Caution

Previous MOBOTIX network power accessories such as the NPA Set, Power Box, and Power Rack (MX-NPA-Set, MX-NPR-4, and MX-NPR8/20) are not suitable for use with the M24M.

No heating is necessary thanks to the well-insulated plastic housing and anti-fogging properties. Due to their low power consumption (approximately 3 watts), MOBOTIX cameras, unlike those of other manufacturers, may be operated both indoors and outdoors using a PoE power supply.

Logos, Animated Or Freestyle

The MOBOTIX camera logo generator allows time-scheduled banners and graphics (including files loaded automatically from any URL) to be integrated into the current camera images. MOBOTIX cameras are the only network IP cameras supporting animated and transparent graphics.

Logo generator for
displaying graphics
already integrated
in the live image



MxControlCenter – Professional Video Management Free Of Charge

Instead of using a web browser, you can also download the free-of-charge MxControlCenter from the MOBOTIX website (www.mobotix.com), which allows you to quickly display live images with audio transmission from high-resolution MOBOTIX cameras. In addition, MxControlCenter can process incoming alarms with lip-synchronous sound and allows comfortable search and evaluation of alarm video clips. The integrated Layout Editor of MxControlCenter allows you to quickly create floor plans by simply dragging/dropping the cameras onto a background image. Load a floor plan as background image, drag and drop the cameras; done!



Also manages **several hundred cameras** all on one standard PC

Free download at www.mobotix.com

No license costs
Free updates

MxEasy – Intuitive Application For Windows, Apple And Linux

The new MOBOTIX MxEasy aims at easy operation of the most important camera functions through its intuitive user interface, thus creating a new user experience when viewing and controlling MOBOTIX cameras. The clear design allows up to 16 cameras to be managed, and the application can show up to four cameras at the same time.

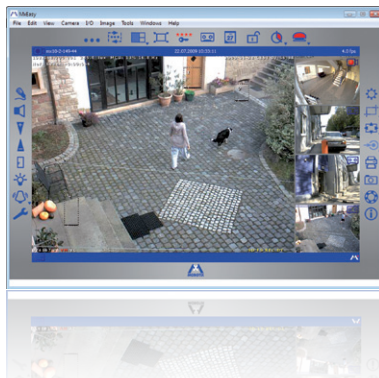

Suitable for up to 16 MOBOTIX cameras

Free download at www.mobotix.com

No license costs
Free updates

All settings selected in MxEasy (for example, virtual camera position, zoom, brightness, volume, microphone sensitivity, image storage, signal outputs) are usable immediately and are stored instantly in the configuration of the corresponding camera. The calendar function integrated in the **Alarm Planner** provides access to innovative features for scheduled settings of one or more cameras.

For the first time, this tool not only controls video and audio recording based on certain time and date information, but also allows features like video motion detection, image brightness, and the microphone to be activated/deactivated based on a date and time schedule.

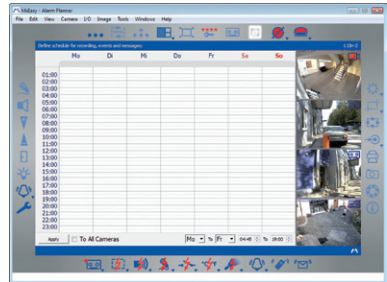

MxEasy is available as a free-of-charge download for the Windows and Mac OS X operating systems under www.mobotix.com. A Linux version will be available soon.

Diverse Installation Options

Not only can MOBOTIX cameras be used under almost all weather and temperature conditions, they also offer suitable installation materials from a wide range of accessories for any conceivable application scenario.

Additional Camera Functions (Software)

- **True software scaling** to easily generate smaller image formats for PDAs (such as 320 x 240, 160 x 120, etc.)
- **Audio-video recording** with three different recording modes: event recording with audio, continuous recording with variable frame rate and audio as well as event-controlled snapshot recording of JPEG images
- **Storage failure detection** can monitor a file server (or a flash device) and can use one or more of the defined messaging options for error notification
- **Player of recorded images/video sequences with audio** in the integrated video management system
- **Multivatcher screen can display and monitor several cameras** over the Internet, with only one camera requiring access from the outside. This "proxy" camera uses only very little bandwidth, making it an ideal solution for low-bandwidth connections
- **MultiView screen for displaying multiple cameras** or events in one browser window
- **Event notification** by e-mail, text messaging (using a service provider), voice notification (Phone Call-Out), sounds, and by visual means (for example, red frame in live image) using two separate messaging paths
- **Object tracing** for analyzing the paths of objects that are moving in the image

- **Time Tables** with handling of customized holidays and vacations. The time tables are used to control the camera's arming, image recording messaging, logos, the obscure image function as well as other features.
- **Remote signaling for master/slave cameras**, with the master camera controlling the arming status of the slave cameras. This allows, for example, all slave cameras to be armed using a key switch connected to the master camera.
- **Transfer profiles** for comfortably controlling transmissions via FTP, e-mail, phone calls and network messages
- **Speakerphone*** with speak, listen and intercom modes using the microphone and speaker
- **Phone Call-In* to remotely control the camera using a touchtone telephone** (retrieve camera information, establish an Internet connection, announce the retrieved IP address, intercom feature, etc.)
- **MxPEG video compression** using MxControlCenter. The ActiveX plug-in for Internet Explorer users brings all advantages of MxPEG to the browser-based user interface (including the audio stream to and from the camera)
- **Routing** allows use of other network connections besides the standard route
- **DynDNS client** for accessing the camera via the Internet using a symbolic name (for example, mymobotixcam.dyndns.org), despite the provider assigning a new dynamic IP address every time the camera connects to the Internet
- **Non-voidable backup system** starts the cameras in the original operating state if a software update fails, allowing the user to easily restart the update process
- **Enhanced startup options** for the camera (obtain IP address via DHCP, announcement of IP address and other network data, reset to factory default settings)
- **Notifications upon errors or when rebooting** provide a method for executing one or more notifications (for example, blinking of the camera LEDs, audio message, FTP, e-mail, phone call, network message)
- **Extended security features** protect the pages and features of the camera and prohibit unauthorized access (IP-level access control, intrusion detection). They also provide SSL-protected transmission of the video sequences and the data (using SSL encryption and X.509 certificates).

* Telephony features using VoIP connections (Internet telephony)

Free Software Updates (www.mobotix.com)

MOBOTIX provides **software updates free of charge** at regular intervals that improve and expand the camera's functionalities. Chapter 6, *Software Update*, in the *Software Manual* provides more information on the process.

Free software updates at www.mobotix.com

1.5 Lenses Options, Hardware And Software Features

MOBOTIX offers the M24M with **lenses in three different classes of focal length**. Since MOBOTIX cameras are backlight-proof, none of these lenses requires a mechanical auto iris, thus making the camera extremely robust and maintenance-free. MOBOTIX lenses deliver good image quality even when using maximum digital zoom.

M24M With Standard Lenses And M14 Thread

A total of **five different MOBOTIX lenses** are offered:

- L22 Super Wide Angle with 90° image angle (horizontal)
- L32 Wide Angle* with 60° image angle (horizontal)
- L43 Wide Angle with 45° image angle (horizontal)
- L65 Telephoto with 31° image angle (horizontal)
- L135 Telephoto with 15° image angle (horizontal)



The standard lenses can be exchanged at any time without having to dismantle the camera. The camera is shipped either with a **color day sensor** or a **light-sensitive black and white sensor** for low lighting conditions (day or night versions).

M24M With Hemispheric L11 Lens (Fisheye)







The **hemispheric M24M model (M24M-Sec-D11)** is only shipped with one L11 fisheye lens with a **horizontal image angle of 180° and 3.1 megapixel color sensor**. The lens distortion that is specific to each lens is corrected in the live image by the MOBOTIX camera software. Due to the special outdoor-optimized design of the camera, the full sensor image cannot be used with all available image display options (parts of the weatherproof housing may be visible in the image). **With this model, it is not possible to switch to another lens at a later stage.**

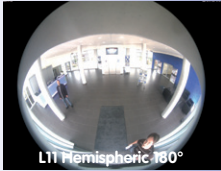

M24M With CSVario Lens

The M24M-Sec-CSVario is shipped with a **CS mount**, a compact **L24-L54 1/2" Vario lens (image angle from 58° to 28°)** and **an optional color or black and white sensor (day/night)**. In addition, commercial **CS and C mount lenses** (C mount lenses with adapter ring) with a diameter of up 36 mm and a length of up to 43 mm that are designed for megapixel image sensors (1/2" and larger) can be used. Using other lenses will produce shadows at the image borders and will reduce image sharpness.



Lenses	L11	L22	L32	L43	L65	L135	CS Vario
Original image							
35 mm equivalent	11 mm	22 mm	32 mm	43 mm	65 mm	135 mm	24–54 mm
Actual focal length	1.8 mm	4 mm	6 mm	8 mm	12 mm	25 mm	4.5–10 mm
Aperture	2.0	2.0	2.0	2.0	2.0	2.5	1.6–2.3
Horizontal image angle	180°	90°	60°	45°	31°	15°	73°–37°
Vertical image angle	160°	67°	45°	34°	23°	11°	58°–28°
Dist. 1 m	m	m	m	m	m	m	m
Image width	infinite	2.0	1.1	0.8	0.5	0.3	1.5–0.7
Image height	11	1.3	0.8	0.6	0.4	0.2	1.1–0.5
Dist. 5 m	m	m	m	m	m	m	m
Image width	infinite	10.0	5.7	4.1	2.7	1.3	7.4–3.3
Image height	55	6.6	4.1	3.0	2.0	1.0	5.5–2.5
Dist. 10 m	m	m	m	m	m	m	m
Image width	infinite	20.0	11.5	8.2	5.5	2.6	14.8–6.7
Image height	110	13.3	8.2	6.1	4.0	1.9	11.1–5
Dist. 20 m	m	m	m	m	m	m	m
Image width	infinite	40.0	23.0	16.4	11.0	5.2	29.6–13.3
Image height	220	26.6	16.4	12.2	8.0	3.8	22.2–10
Dist. 50 m	m	m	m	m	m	m	m
Image width	infinite	100.0	57.5	41.0	27.5	13.0	74–33.3
Image height	550	66.0	41.0	30.5	20.0	9.5	55–25

Notes

The specified focal lengths of MOBOTIX lenses do not reflect the actual focal length of the lenses, but the focal length (Lxx mm) converted to 35 mm camera format. For example, the MOBOTIX L22 Super Wide Angle lens has an actual focal length of 4 mm. This would be the equivalent of 22 mm on a 35 mm camera. It is therefore referred to as an L22. Since the image sensors in digital cameras have different sizes, converting the focal lengths to 35 mm camera as a known format allows the image formats and the fields of vision of the different lenses to be calculated and compared more easily. Another benefit is that you can easily set a 35 mm camera (analog or digital) to the same focal length as the MOBOTIX lens (Lxx) to obtain the same field of vision. This approach greatly facilitates lens selection.

	M24M-IT <i>MX-M24M-IT-D22</i>	M24M-Sec <i>MX-M24M-Sec-D22</i>	M24M-Sec-Night <i>MX-M24M-Sec-Night-N22</i>	M24M-Sec-Hemispheric <i>MX-M24M-Sec-D11</i>
				
M24M Hardware Features				
Outdoor weatherproof	IP66	IP66	IP66	IP66
Ethernet/Mini USB*	X/X	X/X	X/X	X/X
MicroSD slot	X	X	X	X
Mono (M)/Dual (D)	M	M	M	M
Image sensor	Color	Color	B/W	Color
Lens	L22	L22	L22	L11
Resolution	VGA	3 MEGA	1 MEGA	3 MEGA
Resolution horizontal x vertical	640 x 480	2048 x 1536	1280 x 960	2048 x 1536
Max. frame rate CIF/VGA/MEGA/3MEGA (fps)	16/16/-/-	30/30/30/20	30/30/30/-	30/30/30/20
Sensitivity at 1/60 second (lux)	1	1	0.1	1
Sensitivity at 1 second (lux)	0.05	0.05	0.005	0.05
RAM storage (MB)	64	128	128	128
Temp. video storage, ring buffer (MB)	32	64	64	64
Internal DVR (MicroSD card), ring buffer (GB)**	up to 32	up to 32	up to 32	up to 32
• CIF images (for 32 GB int. DVR), approx.	2 million	2 million	2 million	2 million
• VGA images (for 32 GB int. DVR), approx.	1 million	1 million	1 million	1 million
• MEGA images (for 32 GB int. DVR), approx.	-	350,000	350,000	350,000
• 3 MEGA images (for 32 GB int. DVR), approx.	-	160,000	-	160,000
Speaker and Microphone	X	X	X	X
Warranty (months)	24	24	24	24
Concealed cabling	X	X	X	X
M24M Software Features				
Digital zoom (continuous) with panning	X	X	X	X
Additional storable views	X	X	X	X
Full image recording	X	X	X	X
Video motion window	X	X	X	X
Exposure windows	X	X	X	X
Echo elimination	X	X	X	X

*Special Mini USB adaptor cable available as an accessory

**A 4 GB MicroSD card is shipped with all M24M models

MicroSD cards of up to 32 GB may be used (SDHC)



Software Features (All Models)

	Basic Model	Web Model	IT Model	Secure Model
Digital zoom (continuous) with panning	X*	X	X	X
Motion JPEG/MxPEG video streaming	X/X	X/X	X/X	X/X
Custom exposure windows	X	X	X	X
Video motion detection	X	X	X	X
Time and event control (FTP, e-mail, logos)	X	X	X	X
Weekly schedules/holidays	-	X	X	X
Web functionality (FTP, e-mail)	X	X	X	X
Quad/MultiView in browser	X	X	X	X
Recording/Playback in browser	X	X	X	X
Logo generator, animated	-	X	X	X
Snapshot recording (pre-/post-alarm images)	3	3	10	50
Terabyte ring buffer (Win/Lin/Mac) via network	-	-	X	X
Continuous video/audio recording, 0.2 to 30 fps	-	-	X	X
Video/audio recording (event-controlled)	-	-	X	X
Event-controlled frame rate with continuous audio	-	-	X	X
Flexible event logic	-	-	-	X
Master/slave arming by one camera	-	-	-	X
Time-scheduled privacy zones, several areas	-	-	-	X
Bidirectional audio (IP) from/to browser	-	-	X**	X**
Customized voice messages	-	-	X	X
VoIP telephony (audio/video, SIP)	-	-	X**	X**
Alarm calls to softphones (SIP) e.g., X-Lite	-	-	X	X
Remote alarm notification (via TCP/IP, IP Notify)	-	-	X	X
RS232 Data Logger/Terminal	-	-	X***	X***
Programming interface/HTTP API	-	-	X	X
Security features (HTTPS/SSL, IP-level access control, network authentication IEEE 802.1X)	X	X	X	X

Model Feature List

	Basic Model	Web Model	IT Model	Secure Model
Image size	VGA	3 Mega	VGA	3 Mega
Image sensor	Color	Color	Color & B/W	Color & B/W
Standard lens for software version	L22	L22	L22	L22
Audio support (Microphone/Loudspeaker)	-/L**	-/L**	M/L**	M/L**

The web version is only available for the M12

The Basic version is only available for the D24M and Q24M

The IT version is not available for the Q24M

*Only available for Q24M

**D24M IT and Secure models allow an external speaker and microphone to be connected. D24M cameras are not shipped with a microphone or speaker.

***RS232 only for M12/D12

BW image sensors with megapixel resolution (1280 x 960 pixels)

M12 lenses included if requested by customer

2 INSTALLATION

Although the M24M is primarily designed for installation on walls and ceilings, it can also be installed on a mounting pole using the appropriate MOBOTIX accessories. The different installation options are described in Sections 2.4 and below, while the drilling templates are included at the end of the manual.

2.1 Preparing The Installation

Before installing the MOBOTIX M24M, the following questions should be answered:

1. **Where will the camera be mounted?**
Mounting to a wall or ceiling and special features of the L11 lens, see Sections 2.1.1 to 2.1.3
2. **Which other mounting options are available?**
Mounting to a pole with pole mount, see Section 2.1.4
3. **How is the camera connected to the network and how is the power supplied?**
MX-NPA-PoE or other PoE components (IEEE 802.3af), see Section 2.1.5
4. **How are the connections furnished from the building?**
Wall outlets, see Section 2.1.6
5. **What cabling considerations are necessary?**
Wiring, see Sections 2.1.7 and 2.9

The following sections contain an answer to each of these questions, as well as references to the relevant sections in this manual. For more information on the MOBOTIX M24M and currently available accessories, please see: www.mobotix.com.

2.1.1 Flexible Installation Using VarioFlex Mount

Like all MOBOTIX cameras, the **M24M is extremely flexible** in terms of how and where it can be installed. An M24M can be used for both indoor and outdoor applications. In fixed or mobile applications - constantly changing locations or in/on vehicles of any kind. The M24M cameras have been certified **weatherproof according to IP66** and can work reliably in temperature ranges from -30 °C to +60°C (-22°F to +140°F) without extra housing, heating or fan. A practical sun protective cover is integrated into the extremely resistant housing, which is made of UV-resistant special-purpose plastic.

Thanks to the camera's unique VarioFlex mounting system (supplied as standard), the M24M camera can be mounted quickly and easily on any wall, ceiling or even a round pole of up to 18 cm in diameter (when combined with the stainless steel pole mount). The VarioFlex mounting system allows a wide positioning range in both the horizontal and vertical directions (rotating and tilting) to enable precise adjustment to suit the area to be monitored. **The mount also fits directly over flush-mounted RJ45 sockets (without the frame)** to fully conceal the cable, thus improving the watertightness and security of the installation.

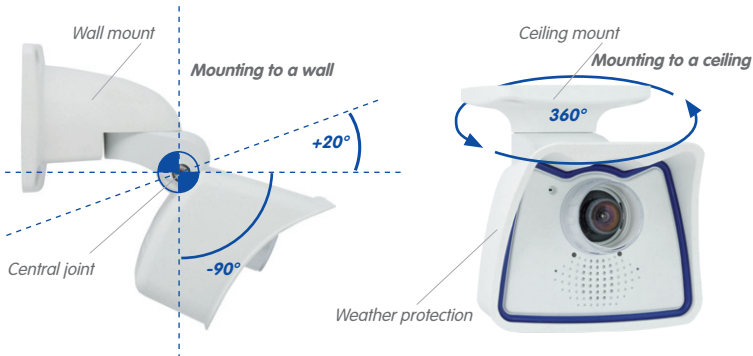

Mounting to a wall

- horizontally: 180°
- vertically: -90° to $+20^\circ$

Mounting to a ceiling

- horizontally: 360°
- vertically: -90° to $+20^\circ$

The VarioFlex mount consists of a central joint, which is directly screwed into place with the weatherproof housing, and a wall and ceiling mount, which is fastened to the central joint with just one screw. In addition to being easy to install, the VarioFlex mount enjoys the advantage of **completely concealed cabling** and high impermeability to water and dust (IP66). Wall and ceiling mounts are designed so that they can be mounted over conventional flush-mounted sockets (without the frame) or cavity sockets and conceal them completely.

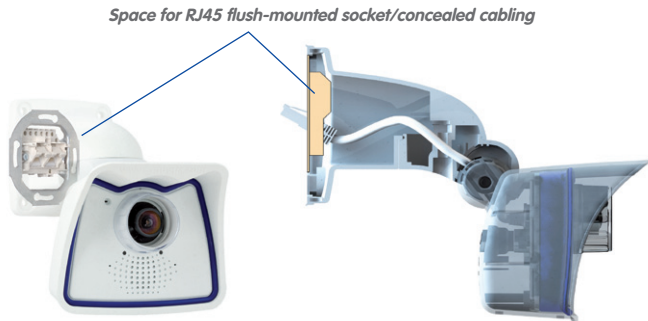

VarioFlex mount with protected cabling and cover for flush-mounted sockets

Make sure that you have found the best camera position before mounting the camera. It is important that the camera's field of view is not obstructed in any way. Once the camera has been mounted to a wall or ceiling, you can fine-tune its position. If the monitored area changes from time to time or the camera has to be installed in a different location, the camera lens can be exchanged in just a few easy steps and used, without having to upgrade to new video software (does not apply to the M24M-Sec with hemispheric L11 lens).

2.1.2 Mounting To A Ceiling Or Wall

Mounting To A Wall

The M24M can be mounted to the wall of a building or structures, even mobile surfaces, for both indoor and outdoor use. The camera is mounted using the pre-installed **VarioFlex mount (supplied as standard)**, which is easily secured using the four enclosed screws and screw anchors (depending on the surface, it can also be mounted without screw anchors directly over the flush-mounted socket). The Ethernet connection cable of the camera has already been guided through the mount and simply needs to be connected with the network cable. By adjusting the VarioFlex mount as required, the captured image area can be precisely adjusted to the desired practical application. **The camera can be turned or tilted 180° horizontally and 110° vertically (from -90° to +20°).**

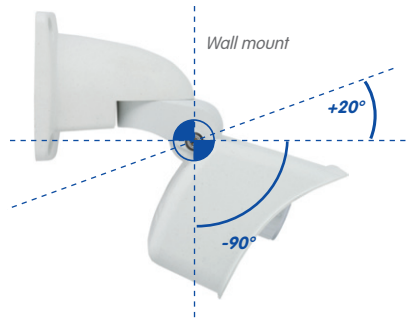

Mounting to a wall

- horizontally: 180°
- vertically: -90° to +20°

Mounting To A Ceiling

By exchanging the wall mount for the separately supplied ceiling mount, the M24M is ready to be **mounted to ceilings in just a few easy steps** thanks to the VarioFlex system. This mounting option is of particular benefit when monitoring rectangular rooms with a single camera. In such cases, the Super Wide Angle lens (90°, L22) allows the room to be monitored almost entirely by an M24M mounted to the ceiling in one of the corners. Using the PTZ software, you can easily zoom in on image details in either the live image or the recording. **The camera can be turned or tilted 360° horizontally and 110° vertically (from -90° to +20°).**



Mounting to a ceiling

- horizontally: 360°
- vertically: -90° to +20°

2.1.3 Mounting Tips For The M24M With L11 Lens (180° Fisheye)

The camera must be correctly positioned on the wall or ceiling in order to be able to use the high-resolution hemispheric image display option of the M24M with L11 lens. The entire hemisphere of the room in front of the camera is then effectively monitored.

High-Resolution Panorama Images

The M24M with L11 lens is primarily suited to providing an excellent **overview in the form of a high-resolution panorama image**, and less suitable for more exact details. For active operation, the camera should be mounted at an (out of direct reach) **height ranging from 2.50 m to 3.50 m**. People, for example, may be **identified very well at distances of up to 1.50 m**, and **with sufficient detail at up to 3 m**. Objects can be recognized even at distances of **5 m and more from the camera**. During installation, ensure that the camera is focused on the most important areas of the room as directly as possible, in order to optimize image quality and to provide the desired level of detail recognition. This applies above all to wall and ceiling installations that must be carried out at greater heights for technical or other reasons (over doors, windows, etc.). Only by tilting the camera appropriately can the lens capabilities be fully utilized.

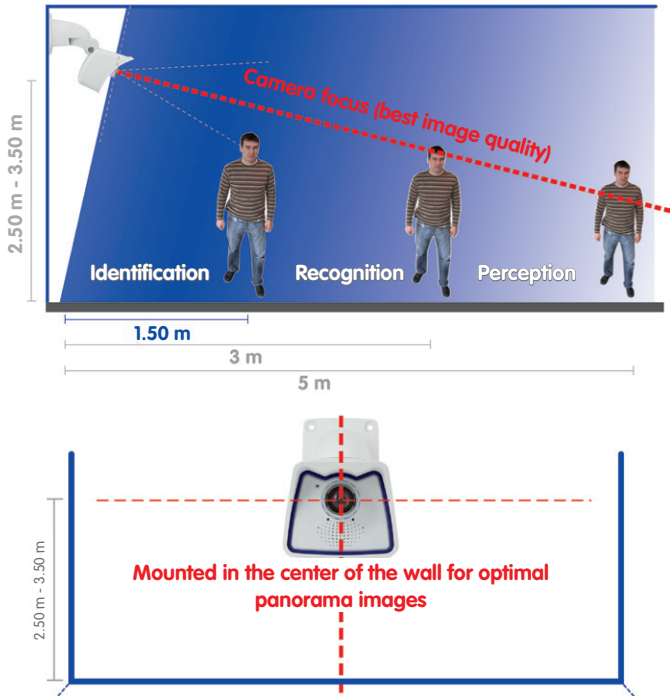

MOBOTIX
recommendation



MOBOTIX original
180° Panorama
image (L11 lens)

The allround view of the M24M is restricted by the weatherproof cover, which can be offset by panning/tilting/zooming the image

MOBOTIX recommends the Q24M with optional In-Ceiling Set as a discreet and powerful overview camera with a 360° allround view



Allround View

Thanks to its hemispheric lens, a single M24M can monitor an entire room right into each of the four corners (360° Allround View). The camera's ideal position is on the ceiling in the center of the room at an angle of 90°. Due to its inherent physical and optical properties, the precision of the lens decreases as the distance from the lens grows. This means that the maximum usable image area greatly varies with the purpose of the camera. Rooms with a square floor area of up to approx. 40 m² (48 yd²) in general allow details to be identified even at the borders of the full image. If you would only like to know if persons enter a room or for monitoring specific objects, rooms with up to 100 m² (120 yd²) floor area can be monitored using a single M24M.

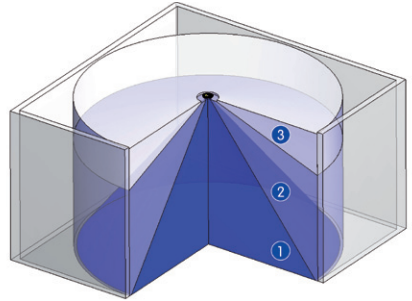

The image quality (precision) diminishes as the distance of an object to the camera focus point increases: 1 very good, 2 good, 3 satisfactory

Furthermore, the "camera view from top to bottom" can also be achieved by mounting the camera to a wall or a pole at a tilt of 90°.

Allround View In Rectangular Rooms

When viewing a 360° allround image in the browser, you will notice that at the top and the bottom of the image edge, small part of the image information has been cut off. This is not a fault of the camera, but an intended behavior that aims at achieving the best possible utilization of the image sensor by the camera software. Bearing this in mind, it is advisable to install the M24M in rectangular rooms so that the camera lens is first directed towards the center of the two longer walls and then vertically tilted towards the ground.

M24M ceiling installation with 90° tilt for vertical view downwards

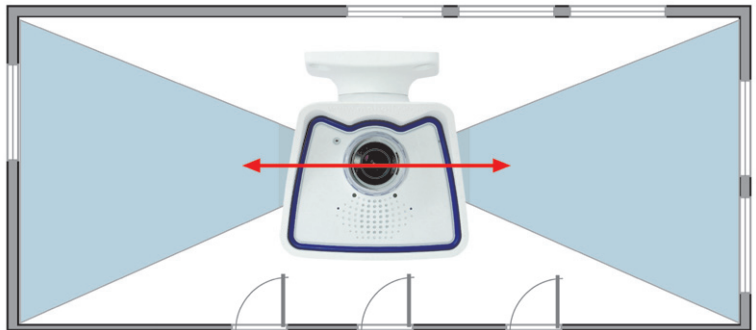

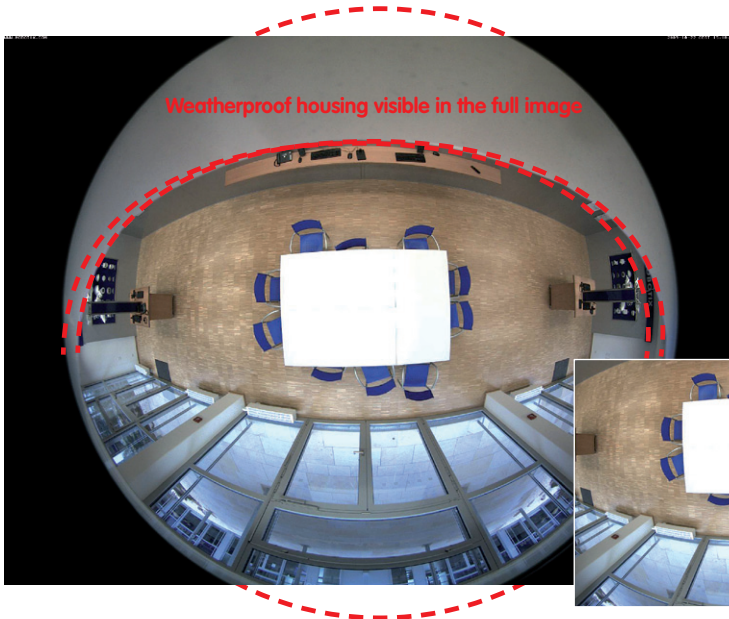

MOBOTIX original full image (ceiling installation in a rectangular room)

Panning/tilting/zooming removes the area concealed by the weatherproof cover

Note

Part of the captured image area is concealed behind the protective cover of the M24M housing, especially in the full image. For this reason, M24M cameras with L11 lens should be adjusted so that the concealed areas are not those that are supposed to be monitored. By panning/tilting/zooming the image, the concealed area can be completely removed from the image.

2.1.4 Optional: Mounting To A Pole (With Accessories)

Installation on round poles is frequently used for cameras that are intended for mobile outdoor use. For this purpose, MOBOTIX recommends using the pole mount, which is available for the M24M as an accessory and is almost indestructible (MX-MH-SecureFlex-ESWS). This pole mount is made from rust-proof stainless steel with a white coating and is used in combination with the pre-installed VarioFlex mount supplied as standard with the wall mount.

Poles with a diameter between 60 and 180 mm can be used. It is particularly advisable to use cavity (metal) poles, in which the network cable is not visible and can be protected from attacks. For more detailed information on the installation process, see Sections 2.6 and below. The appropriate drilling templates can be found at the end of the manual.



The M24M supports the Power over Ethernet standard IEEE 802.3af (PoE)

The PoE adapter replaces the crossover cable when directly connecting to a computer

For the M24M, you should use the new blue MX-NPA-PoE-Set - previous MOBOTIX network power accessories such as the NPA Set, Power Box and Power Rack (MX-NPA-Set, MX-NPR-4 and MX-NPR8/20) are not suitable for use with the M24M



2.1.5 Network Connection And Power Supply, UPS

Power over Ethernet (PoE Conforming To IEEE 802.3af)

All M24M models are supplied with power using the PoE standard. The PoE Adapter Set (MX-NPA-PoE Set) may be used for smaller installations. For larger installations, it is worth investing in a PoE-capable supply device available on the market. **Sections 2.9 and below contain more information on the possible combinations of connecting the M24M and power supply options.**

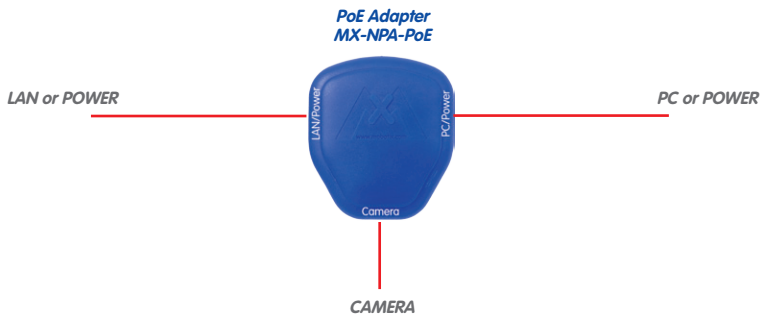

Caution

The **maximum length** of the network cable for power supply over an Ethernet cable is **100 m**.

Previous MOBOTIX network power accessories such as the NPA Set, Power Box, and Power Rack (MX-NPA-Set, MX-NPR-4, and MX-NPR8/20) are **not** suitable for use with the M24M.

Note

The MOBOTIX M24M can be powered by switches or routers that support the PoE (Power-over-Ethernet) standard and conform to IEEE 802.3af.

Advantages of PoE power supply:

- Advantages of centralized backup power supply are available via network
- Lower, more cost-effective power consumption
- Camera does not require an additional network connection

Using Uninterruptible Power Supplies (UPS)

In order to maintain a continuous power supply even when utility power fails, you should install an uninterruptible power supply (UPS). These devices also provide full protection against electrical surges and voltage fluctuations and thus enhance the reliability of the system as a whole.

When using a more powerful 19" rack-mounted UPS, you can also protect all other network components (for example, switches, routers, PoE switches, etc.).

Since MOBOTIX cameras do not require any heating, even during winter, the average power consumption of approximately 3 watts is very low. This in turn means that you can centralize the UPS-protected power supply by injecting power into the network cables (max. 100 m/109.36 yd). This kind of protected power supply can be used either with MOBOTIX PoE products (MX-NPA-PoE + Universal Power Supply) or with PoE-compliant switches according to IEEE 802.3af.

UPS not only protect against power failures, they also protect all other connected network devices against damage from voltage peaks and lows

19" system with UPS

Camera power supply using PoE enables centralized UPS via network (increased security)

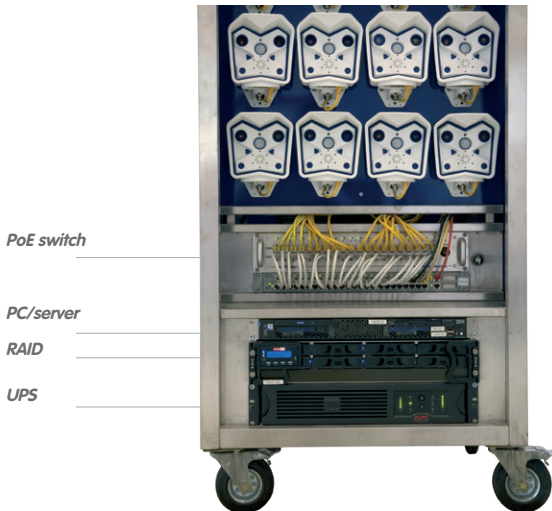

2.1.6 Preparing The Camera Connections, Wall Outlets

Once the camera position, the position of the cable connectors, and the method of power supply have been decided upon, the cabling can be installed. Before mounting the MOBOTIX M24M, you should make sure that the network connections have been properly tested, so that the proper functioning of the camera is guaranteed.

2.1.7 Wiring, Fire Prevention, Lightning And Surge Protection

When installing the wiring inside or outside of buildings, make sure you always adhere to the relevant regulations on wiring, fire prevention, and protection against lightning.

MOBOTIX cameras are protected against the effects of small electrical surges by a range of measures. These measures, however, cannot prevent the camera from being damaged when stronger electrical surges occur. Particular care should be taken when installing the camera outside to ensure proper **protection against lightning**, as this also protects the building and the entire network infrastructure.

MOBOTIX recommends having MOBOTIX cameras installed only by certified specialists accustomed to installing network devices and having proper respect for the applicable regulations regarding lightning protection and fire prevention as well as the current technology for preventing damages from electrical surges.

Wiring

When installing the wiring, make sure to follow these guidelines:

- **Data cable:** Make sure you only use double-shielded CAT5 or higher cable (**S/STP**) for Ethernet connections.
- **Outdoors:** Installing the camera outdoors requires special precautions and measures regarding the cables as well as lightning and surge protection.
- **Wire lengths:** The cable segments must not exceed the maximum allowed cable lengths in order to ensure proper data transfer (see Section 2.11).
- **Avoiding induction:** When running data cables parallel to existing regular power lines or high-voltage wires, make sure you observe the minimum distances to the power cables.



Fire Prevention

When installing the power lines to the camera, make sure you always adhere to the country-specific regulations (for example, VDE in Germany, IEEE in the U.S.) in effect on wiring and fire prevention at the site of the installation.

Lightning And Surge Protection

More information on preventing lightning or surge damage is available from organizations such as the International Electrotechnical Commission (www.iec.ch) or from the manufacturers of lightning and surge protectors (for example, Dehn: www.dehn.de).



2.2 M24M-IT/Secure: Delivered Parts, Components, Dimensions

2.2.1 Delivered Parts And Camera Components



Lens wrench (1.6)
with the M24M-
Sec-D11 only

Item	Quantity	Part Name
1.1	1	Camera in weatherproof housing including VarioFlex wall mount
1.2	1	Ceiling mount
1.3	1	Seal for wall and ceiling mount
1.4	1	Lens, mounted (standard M14, CSVario, or L11)
1.5	2	Lens cover, 1 mounted, 1 replacement (cover for CSVario not pictured)*
1.6	1	Lens wrench L11 (with M24M-Sec-D11 only)
1.7	2	Allen wrench 5 mm, Allen wrench 2.5 mm
1.8	1	Special patch cable, 0.5 m, pre-installed
1.9	4	Caps for stainless steel wood screws
1.10	4	Stainless steel wood screws with hex head 6x50 mm
1.11	4	Stainless steel washers 6.4 mm
1.12	4	Screw anchors S8
1.13	2	Cable retainer with bayonet catch (patch cable, Mini USB)
1.14	1	4 GB MicroSD card
1.15	1	Lock plug Mini USB

* The M24M with
L11 lens has a lens
ring including seal

2.2.2 Camera Housing And Connectors

The MOBOTIX M24M consists of the camera in the weatherproof housing and the VarioFlex mount.

Connectors

- Network (Ethernet network including PoE supply)
- Mini USB (e.g. for ExtI/O)
- MxBus (for future updates)



Make sure that the white ring remains in the lens cover as this ring reduces light reflections and prevents the camera LEDs from adding reflections to the images

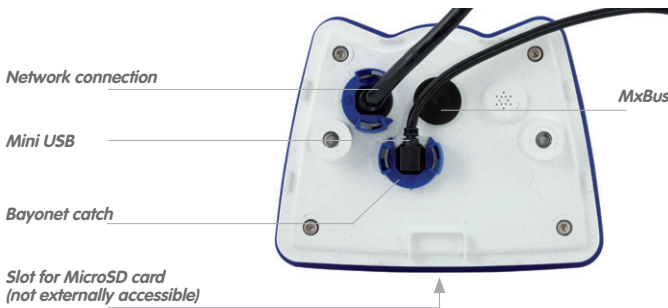
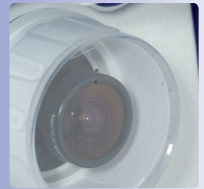

Note**Note on fastening cables leading into the camera:**

Cables passing in to the back of the camera (patch cable for the network connection and for Mini USB) are secured using a special cable retainer with bayonet catch.

When replacing this cable, ensure that the cable is properly seated in the port and that the retainer with the blue bayonet catch is locked (short clockwise turn until it clicks into place).

**Removing The Cable Retainer**

Rotate the bayonet catch counterclockwise to the "open circle" symbol (see diagram). The catch may be removed from the side. The cable can now be pulled out of the camera.

Open the cable retainer by rotating the bayonet catch to the marked position

Bayonet catch open



Caution

Only use **original MOBOTIX cable** to connect the camera. Standard cables purchased from other suppliers do not meet the necessary specifications for proper protection (no longer weatherproof according to IP66).



Ethernet patch cable



Mini USB cable

MOBOTIX patch cables are available as accessories in different lengths (1 m, 2 m, 5 m and 10 m)

Replacing The Cable Retainer

Insert the cable into the receptacle on the camera. Position the bayonet catch from the side (opening points to the right). Rotate the bayonet catch clockwise to the "filled circle" symbol (see diagram). The cable is now properly retained.



Close the cable retainer by rotating the bayonet catch to the marked position

Bayonet catch closed



2.2.3 Dimensions (mm) For Wall Installation

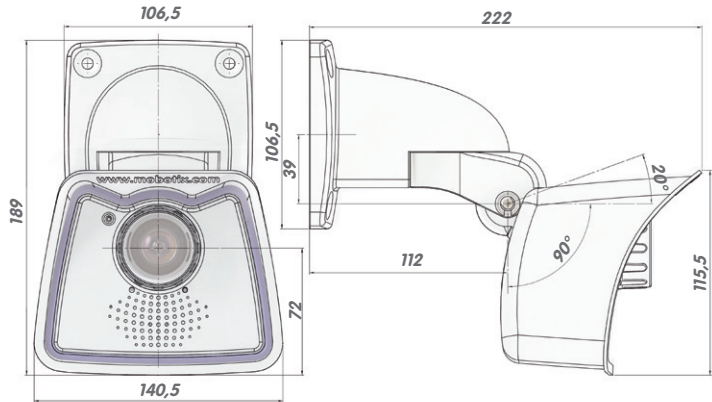

2.2.4 Dimensions (mm) For Ceiling Installation

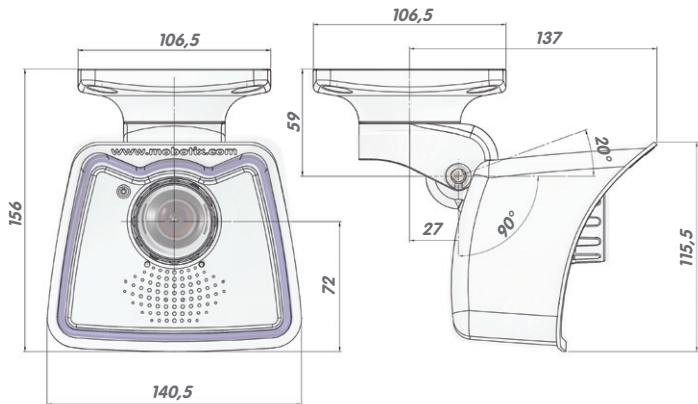

2.2.5 Dimensions (mm) Of Wall Mount

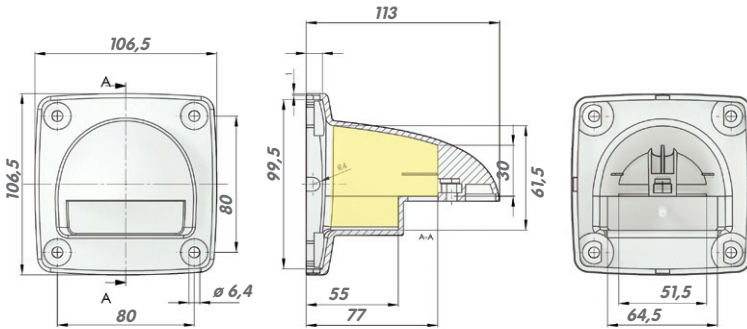

With the ceiling mount, the size of the contact surface is identical to the wall/ceiling and to the position of the drill holes

2.2.6 Drilling Template (mm) Wall And Ceiling Mount

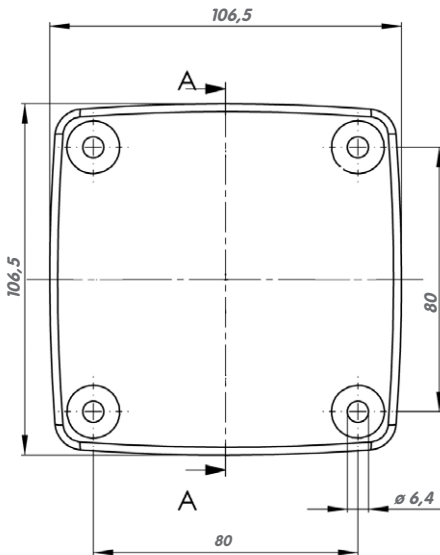

Find the drilling templates (scale 1:1) at the end of the manual as a fold-out

Note

Find the folded drilling template at the end of the manual.

Make sure that the drilling template is not scaled or adjusted to the paper size when printing the PDF file (enlarged or reduced).

2.3 Available M24M Accessories - Overview

NPA-PoE Set (MX-NPA-PoE-EU and MX-NPA-PoE-INT)

The MOBOTIX Network Power Adapter Set (NPA-PoE set) is a high-quality, robust, ultra-compact, and, above all, multifunctional PoE injector with three connectors (network, camera/PoE device, PC) and a universal power supply unit with adapter plugs. The Network Power Adapter Set remotely supplies the M24M and all other PoE devices with power in accordance with the IEEE 802.3af standard. This makes it possible to use the network cable to both connect the camera and remotely supply power (up to 100 m). As a result, the M24M can be supplied with PoE power via the adapter and connected directly to your PC (integrated crossover function).



A further advantage of this product is its versatility. The blue adapter can be connected to the different power outlet systems around the world using the power supply unit. The device can also be directly connected to network-independent power sources between 12 V and 42 V. This is ideal for the battery-operated, standalone operation of a network camera. This device is especially practical because the supplied power supply unit can be used around the world by changing the adapters as required in just two simple steps. The "EU" version of the NPA-PoE Set is supplied as standard with a European adapter, while the "INT" version includes 4 adapters (EU, USA, UK, AUS).

Lens Cover With Glass Pane (MX-M24M-OPT-LCSG)

As an additional accessory, the M24M with standard lens (M14 thread) can be supplied with a protective cover that has a glass pane instead of one made of plastic. This will improve the durability of the lens cover when used in extremely rough conditions (at sea, in sand storms, etc.). This lens cover also has a thread size that fits external filters (40.5 mm x 0.5 mm) available from photo shops. For example, you could install a polarization filter to cancel out the reflections from windowpanes or windshields. Using this lens cover together with the L22 Super Wide Angle lens is not recommended, since this lens cover produces shadows at the image borders. The (longer) cover supplied with M24M models with the CSVario lens is equipped with the glass pane as standard.



MX-M24M-OPT-LCSG



MX-M24M-OPT-LCGL

Ethernet Patch Cable, 1–10 m In Length (MX-OPT-CBL-LAN)

The Ethernet patch cables for the M24M were developed by MOBOTIX and have a specially integrated seal. Every M24M is supplied with a 0.5 m long patch cable as standard. Patch cables of 1 m, 2 m, 5 m, and 10 m in length can also be ordered on request.



M24M Pole Mount (MX-MH-SecureFlex-ESWS)

If you are intending to mount the camera to a pole, you should consider using the MOBOTIX Pole Mount for M24M cameras. This mount is made of 3 mm powder-coated stainless steel (white) and has been designed specifically for outdoor use. The supplied stainless steel straps allow the mount to be attached to poles with diameters between 60 mm and 180 mm (2.4 in to 7.1 in). By design, the pole mount does not allow the use of a flush-mounted wall outlet.



CamIO For M24M - Available In 2010

CamIO is an extension module for MOBOTIX cameras that provides numerous connectors for external devices and expands the scope of the camera to include various control and switching features.

The CamIO Box (MX-CAM-IO), which is still available for M12/M22 cameras, is no longer compatible with the M24M due to the modified system platform. A new CamIO especially revised for this camera series is currently in the planning stages and will be available in 2010.



CamIO for M24M will be available in 2010

ExtIO Function Extension (MX-ExtIO)

The ExtIO contains a powerful speaker, microphone, infra-red motion sensor, environmental temperature sensor, 2 input and 2 output contacts and 2 illuminated buttons. It is ideal for door communication, elevators, access control, etc.

The ExtIO can be operated directly with the M24M over a separately available MOBOTIX USB cable. The ExtIO can operate in two different modes:

- Mini USB: Directly connected to the camera using a separately available cable (max. 5 m)
- Ethernet: Connect the ExtIO over a standard PoE switch; maximum distance to camera 200 m

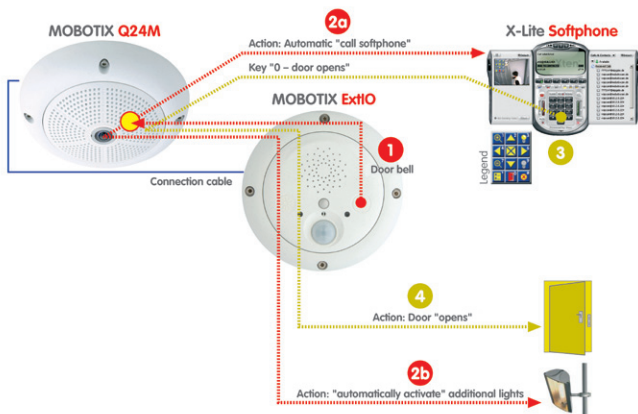

Mx2wire Media Converter (MX-2wire-Set-PW)

The Mx2wire system allows you to set up an Ethernet network with PoE via two-wire cables of up to 500 m in length. This allows an existing two-wire analog telephone line to be connected to a 10/100 Mbps Ethernet device (for example, PC, WLAN, IP camera, IP telephone, or IP door station). The achievable data rate is up to 30 Mbps. Around 15 Mbps can be reached even with 500 m of antenna cable.

An identical Mx2wire device is placed at the beginning and the end of the line. Configuration as sender or receiver is automatic. The Mx2wire units are supplied with power by the feeding network cable. The connected devices are supplied with up to 7 watts over PoE, as the injected PoE signal is transmitted parallel to the network signal. Mx2wire is delivered in the standard wall outlet frame in different designs, however, it can also be used with the available surface-mounted socket that is included.

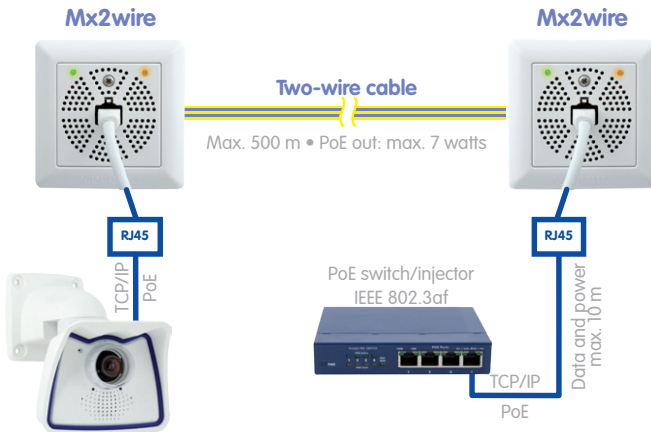
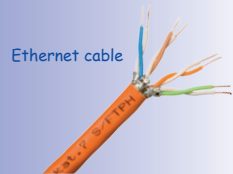
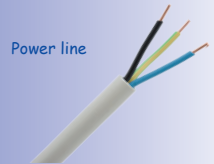
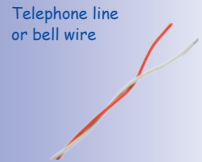

2.4 Mounting The Camera With Wall Mount



2.4.1 Mounting Instructions

See Section 3.9.1



The M24M is an allround camera designed for use in indoor and outdoor applications. The camera must always be installed with the VarioFlex mount, which has been prepared at the factory for wall mounting and allows the cabling to be concealed. The best camera position for the selected lens must be found before mounting the camera to the wall (see Sections 1.2 and 1.5). Once the camera has been mounted to the wall, you can fine-tune its position. **Please read the notes on protecting the camera against condensation (see Section 3.9.1).**

2.4.2 VarioFlex Wall Mount

Using the VarioFlex Wall Mount, the camera can be precisely panned, both **horizontally and vertically**, to suit the area that is to be monitored.

When mounted to a wall, the camera can be turned or tilted as follows:

- horizontally: 180°
- vertically: 110°

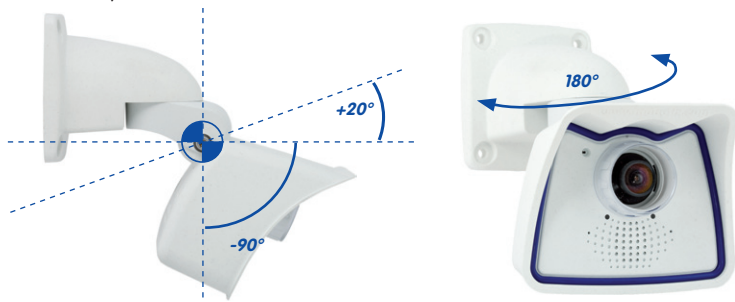

In order to ensure a flush finish with the surface, connect the camera patch cable to the **network cable using a standard adapter** that is protected in the wall mount or **install a flush-mounted socket with RJ45 connector**. When doing so, make sure that the flush-mounted socket is placed as high up in the wall mount housing as possible.

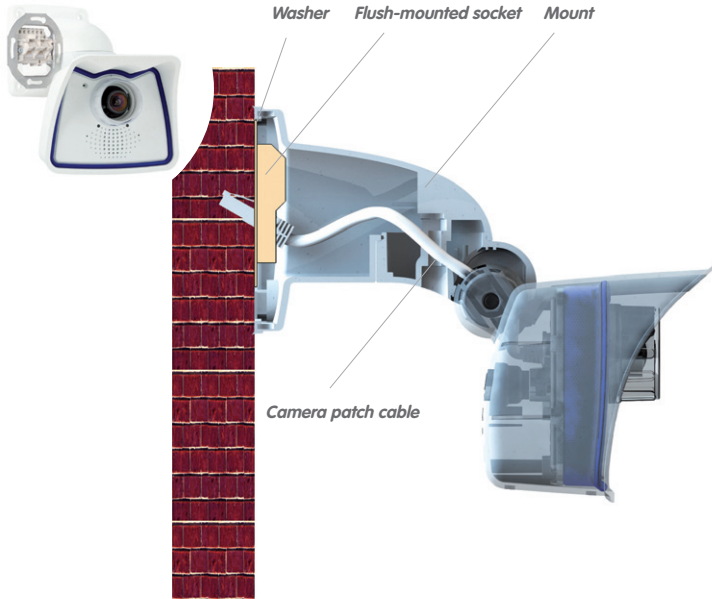

When installing **on-wall cabling**, breaking out one of the four possible openings in the base of the wall mount will ensure that the cables can be fed neatly into the camera. **Caution: If using the camera outdoors, only use the opening at the bottom of the mount for guiding the cables through.** The connection to the camera patch cable can be established using a suitable adapter within the wall mount.

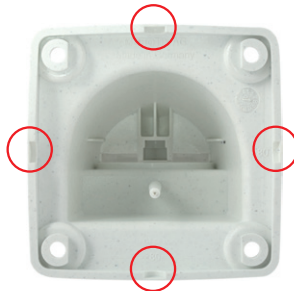

Standard adapter for cable connection

Additional sealing of the wall mount with silicone (on the washer) is recommended for use with uneven surfaces

Pliers to break through a cable guide



2.4.3 Required Tools

Please first check that all components supplied with the camera are present in the original packaging (see Section 2.2).

The following additional tools are required for installation:

- **Screwdriver**
- **Power drill** for screw anchor holes
- **MOBOTIX drilling templates** (at the end of this manual)
- **Scissors** to cut out the template
- **Pen** to mark the drill holes
- **Materials** and any tools needed to connect the pre-installed MOBOTIX network cable in the camera with the on-site network cable



Caution

Never use **screws with recessed heads** to install the VarioFlex mount as these screws will destroy the mount.

2.4.4 Procedure

1. **Install and prepare the network connection:** The pre-installed camera patch cable must be connected with the on-site network cable. The connection can either be established using an installed flush-mounted socket with RJ45 connector or - in the case of a protruding network cable - using a suitable connector within the wall mount. In both cases, the connection is well protected and is neither accessible nor visible from the outside.



MOBOTIX patch cables are available as accessories in different lengths

2. **Drill the holes:** Use the supplied drilling template for the camera (found at the end of the manual). Drill the holes for the supplied screw anchors. Screw anchors do not have to be fitted if the surface is made of wood. To secure the mount, the supplied stainless steel hex head screws will later be screwed directly into the surface. In order to facilitate screwing in wood, the positions should first be predrilled using a 2 mm drill bit, for example (drilling depth just slightly less than screw length).

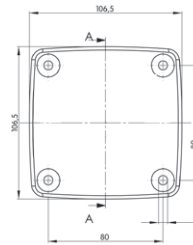

No screw anchors are required for wooden surfaces

3. **Attach wall seal:** Place the white rubber seal with the groove on the edge of the wall mount.



4. **Connect the cable:** Connect the on-site network cable to the camera patch cable using an adapter or insert the patch cable into the RJ45 outlet. Make sure that the cables are not bent or squashed.

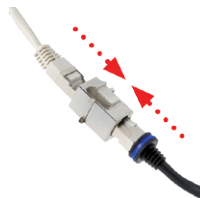

Additional sealing possible, for example, with shrink tubing

5. **Attach the camera:** Place the wall mount over the drill holes and hold it against the wall. Then use the four screws each with a washer and tighten them using the appropriate wrench. Do not overtighten the screws as this may damage the plastic mount. Check that the screws are securely in place and place the white caps on the screw heads. Then position the camera as described in Section 2.7.



6. **Clean the lens cover:** Once you have removed the white protective foil fixed to the front of the lens cover, clean the cover that has already been screwed on with a clean soft cotton cloth for optimal image results. The cover does not have to be removed.



7. **Establish a connection to the camera, check the image:** Establish a connection to the camera as described in Sections 3.1 and below. The live image from the camera should be visible on the computer monitor. Check image sections on the computer monitor.

Note

The VarioFlex mount and Wall Mount must always be used for wall installation. Use the VarioFlex Ceiling Mount for ceiling installation!



2.5 Mounting The Camera With Ceiling Mount



2.5.1 Mounting Instructions

The M24M is an allround camera designed for use in indoor and outdoor applications. The camera is always installed together with the VarioFlex mount, which has been prepared at the factory for wall mounting and can be converted to a ceiling mount in just a few steps. The best camera position for the selected lens must be found before mounting the camera to a ceiling, or to an overhang or balcony (see Sections 1.2 and 1.5). Once the camera has been mounted to the wall, you can fine-tune its position. **Please also read the notes on protecting the camera against condensation (see Section 3.9.1).**

See Section 3.9.1



2.5.2 VarioFlex Ceiling Mount

Using the VarioFlex Ceiling Mount, the camera can be precisely panned, both **horizontally and vertically**, to suit the area that is to be monitored.

When mounted to a ceiling, the camera can be turned or tilted as follows:

- horizontally: 360°
- vertically: 110°

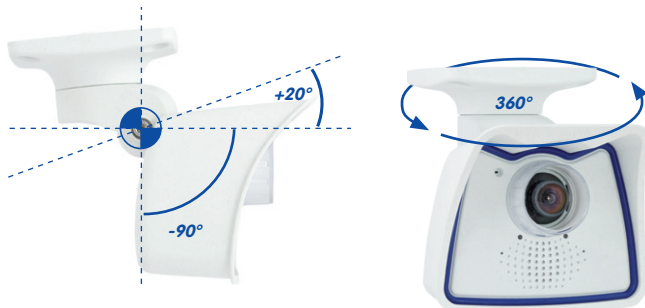

Mounting to a ceiling

- horizontally: 360°
- vertically: -90° to +20°

In addition, a cavity or flush-mounted socket can be installed for the network cable protruding from the ceiling, which allows sufficient space to connect the network cable with the camera patch cable using a standard adapter.

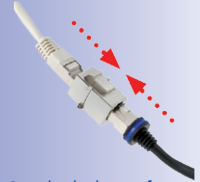
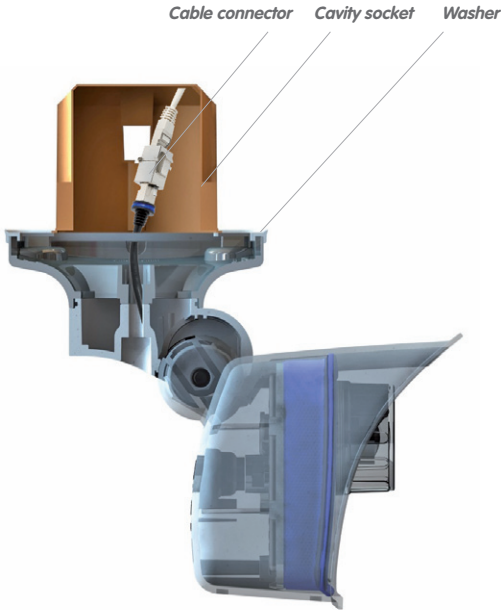

Standard adapter for cable connection

Additional sealing of the ceiling mount with silicone (on the washer) is recommended for use with uneven surfaces

When installing **on-wall cabling**, breaking out one of the four provided openings in the base of the ceiling mount will ensure that the cables can be fed neatly into the camera. The camera patch cable must be connected to the network cable using a suitably sealed adapter.

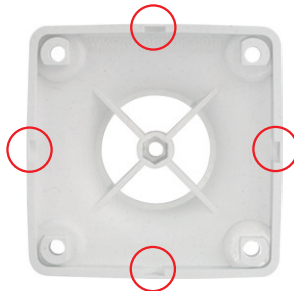

Pliers to break through cable guides



2.5.3 Required Tools

Please first check that all components supplied with the camera are present in the original packaging (see Section 2.2).

The following additional tools are required for installation:

- **Screwdriver**
- **Power drill** for screw anchor holes
- **MOBOTIX drilling templates** (at the end of this manual)
- **Scissors** to cut out the template
- **Pen** to mark the drill holes
- **Materials** and any tools needed to connect the pre-installed MOBOTIX network cable in the camera with the on-site network cable



Caution

Never use **screws with recessed heads** to install the VarioFlex mount as these screws will destroy the mount.

2.5.4 Procedure

1. **Convert to ceiling mount:** Simply remove the lock screw on the central joint and exchange the wall mount for the supplied ceiling mount. Before fastening the ceiling mount to the central joint (using the screw of the wall mount), the patch cable is guided through one of the four openings.



2. **Install and prepare the network connection:** Guide the pre-installed camera patch cable through one of the four openings in the ceiling mount. This will be connected later with the network cable using a suitable adapter, for example, in a pre-installed cavity socket.



3. **Drill the holes:** Use the supplied drilling template for the camera (found at the end of the manual). Drill the holes for the supplied screw anchors. Screw anchors do not have to be fitted if the surface is made of wood. To secure the mount, the supplied stainless steel hex head screws will later be screwed directly into the surface. In order to facilitate screwing in wood, the positions should first be predrilled using a 2 mm drill bit, for example (drilling depth just slightly less than screw length).

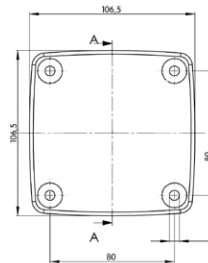

4. **Attach ceiling seal:** Place the white rubber seal with the groove on the edge of the ceiling mount.

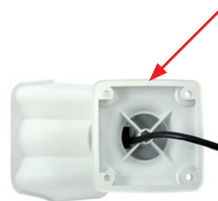

5. **Connect the cable:** Connect camera patch cable via connector. Make sure that the cable is not bent or squashed.

6. **Attach the camera:** Place the ceiling mount over the drill holes, use the four screws each with a washer and tighten them using the appropriate wrench. Do not overtighten the screws as this may damage the plastic mount. Check that the screws are securely in place and place the white caps on the screw heads. Then aim the camera as described in Section 2.7.



7. **Clean the lens cover:** Once you have removed the white protective foil fixed to the front of the lens cover, clean the cover that has already been screwed on with a clean soft cotton cloth for optimal image results. The cover does not have to be removed.



8. **Establish a connection to the camera, check the image:** Establish a connection to the camera as described in Sections 3.1 and below. The live image from the camera should be visible on the computer monitor. Check image sections on the computer monitor.

Note

Use the VarioFlex Ceiling Mount for ceiling installation. The VarioFlex mount and Wall Mount must always be used for wall installation.



2.6 Mounting The Camera With Pole Mount



2.6.1 Mounting Instructions

If you are intending to mount the camera on a pole, you should consider using the MOBOTIX M24M Pole Mount. This mount is made of 3 mm powder-coated stainless steel (white) and has been designed specifically for outdoor use. The supplied stainless steel straps allow the mount to be attached to poles with diameters between 60 mm and 180 mm (2.4 in to 7.1 in). By design, the pole mount does not allow the use of a flush-mounted wall outlet.

The camera is always installed together with the VarioFlex mount, which has been prepared at the factory for wall mounting and therefore can also be secured directly to the pole mount. The best camera position for the selected lens must be found before mounting the camera (see Sections 1.2 and 1.5). Once the camera has been mounted to the wall, you can fine-tune its position.

Please also read the notes on protecting the camera against condensation (see Section 3.9.1).

See Section 3.9.1



2.6.2 Pole Mount (MX-MH-SecureFlex-ESWS)

Using the pre-installed VarioFlex Wall Mount, which is secured to the pole mount simply using four screws and nuts, the camera can be precisely panned, both horizontally and vertically, to suit the area that is to be monitored.

When mounted to a pole, the camera can be turned or tilted as follows, just like wall installation:

- horizontally: 180°
- vertically: 110°

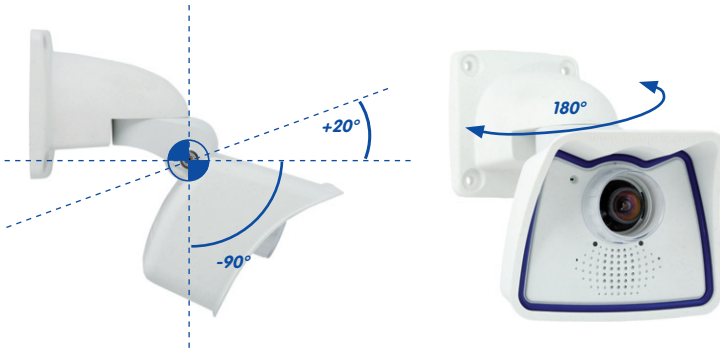

Pole Mount Dimensions



Scope Of Delivery And Required Parts

Please first check that all the components supplied with the Corner and Pole Mount Set are present in the original packaging.

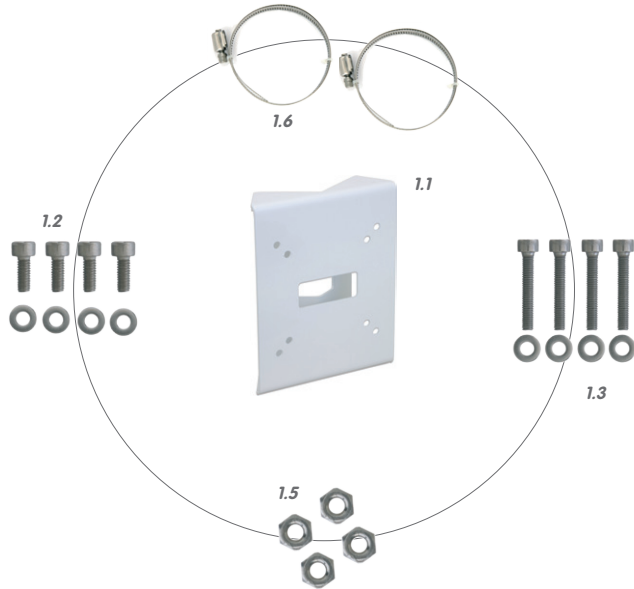

Item	Quantity	Part Name
1.1	1	Pole Mount
1.2	4	Stainless steel hex head screws M6x20 mm
1.3	4	Stainless steel hex head screws M6x35 mm (not required)
1.4	8	Stainless steel washers
1.5	4	Stainless steel hex nuts M6
1.6	2	Stainless steel straps

The following additional tools are required for installation:

- Screwdriver
- Materials and any tools needed to connect the pre-installed MOBOTIX network cable in the camera with the on-site network cable.



2.6.3 Procedure

1. **Prepare the cable:** Guide the on-site network cable from behind through the middle opening of the pole mount. Ideally, the cable should be guided directly from the pole into the cavity socket of the VarioFlex Wall Mount, where it is connected with the camera patch cable via an adapter (concealed cabling).



2. **Prepare the straps:** Guide the two stainless steel straps through the pole mount. The pole must have a diameter between 60 mm and 180 mm.

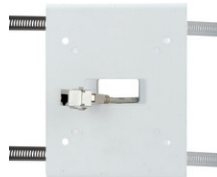

3. **Attach pole mount:** Place the straps around the pole and tighten them using the screwdriver. If necessary, the ends of the straps can be cut off.



4. **Attach rubber seal:** Place the white rubber seal with the groove on the edge of the wall mount.



5. **Connect the cable:** Connect the on-site network cable with the camera patch cable via adapter in the cavity socket of the wall mount. Make sure that the cables are not bent or squashed.



- Attach the camera:** Place the wall mount over the predrilled positions in the pole mount and tighten it using the supplied M6x25 mm screws (item 1.2), washers (item 1.4) and M6 hex nuts (item 1.5).



- Aim the camera:** Aim the camera as desired (see also Section 2.7) while also making sure not to overtighten the screws on the mount so that they do not damage the plastic mount. Check that the mount is securely in place and place the white caps (item 1.9 in the camera scope of delivery) on the screw heads.

- Clean the lens cover:** Once you have removed the white protective foil fixed to the front of the lens cover, clean the cover that has already been screwed on with a clean soft cotton cloth for optimal image results. The cover does not have to be removed.



- Establish a connection to the camera, check the image:** Establish a connection to the camera as described in Sections 3.1 and below. The live image from the camera should be visible on the computer monitor. Check image sections on the computer monitor as well.

Note

The VarioFlex Wall Mount must always be used for pole installation. The VarioFlex Ceiling Mount should **not** be used.

2.7 Adjusting The Camera And Changing The Lens

2.7.1 Adjusting The Camera

1. Establish a connection to the camera as described in Section 3.2 First Images And The Most Important Settings. The live image from the camera should be visible on the computer monitor.
2. **Loosen the screws on the VarioFlex mount using the supplied Allen wrench** so that you can easily turn and tilt the camera.
3. Display the desired camera section on the computer monitor, then turn and tilt the camera until you have found the best position and sharpness. Retighten the screws of the VarioFlex mount to prevent the position of the camera from changing.
4. If required, clean the lens cover using a clean, lint-free cotton cloth.



2.7.2 Correcting The Image Horizon (For L11 Lens Only)

The M24M-Sec with hemispheric L11 lens allows the correction of an uneven image horizon via OnScreen Control that was possibly caused by the installation position. The image horizon is turned by up to 30 degrees clockwise or counterclockwise and can be optically restraightened by clicking on the icons (see image).



Section 3.5 provides more details and information on the functionality of the OnScreen Control

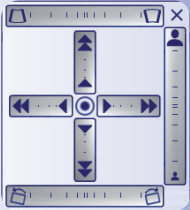

HORIZON CORRECTION

 Rotate image up to -30°

 Rotate image up to $+30^\circ$



2.7.3 Changing The Lens

The M24M can be shipped from the factory with five MOBOTIX standard lenses (L22, 32, 43, 65, 135) with the CSVario lens or the hemispheric L11 lens. This procedure applies equally for all lenses. However, the removal/installation of the lock ring is not required for the M24M-Sec-CSVario nor for lenses with CS or C mounts.

Only lenses with CS or C mounts may be used with the CSVario version of the M24M (Secure model only). Only standard MOBOTIX lenses (L22, 32, 43, 65, 135) with M14 thread may be used with standard versions of the M24M (Secure, IT and Basic). With the M24M 180° hemispheric camera, only the hemispheric L11 lens may be used. Upgrading to other model versions is not possible.

Proceed as follows to change the lens:

1. Remove the **lens cover by turning it counterclockwise**.
2. **Loosen the lock ring of the lens by turning it counterclockwise**.
3. Remove the **lens with the lock ring by turning it counterclockwise**.
4. Unscrew the **lock ring from the lens you just removed** and screw it onto the new lens.
5. **Screw the new lens with the attached lock ring back into the camera**.
6. **Adjust the image sharpness** according to the camera's live image on the computer monitor. To avoid damaging the lens mount, never turn the lens too far or with force.
7. **Tighten the lock ring by turning it in a clockwise direction** to secure the lens.
8. **Screw the lens cover onto the lens again** and clean it, if required, using a clean, lint-free cotton cloth.



Lock ring



The white ring in the lens cover prevents the camera LEDs from adding light reflections to images

The focusing aid provides a visual aid when setting the image sharpness of a MOBOTIX camera lens (see Section 4.3.3 Image and Audio Settings, Quick Controls in the Software Manual).

2.8 Replacing The MicroSD Card

The camera must be taken down to remove, insert or replace a MicroSD card. To avoid data loss, be sure to deactivate MicroSD card recording in the camera software and reboot the MOBOTIX camera before removing the card.

Caution

A MicroSD card may only be removed from the camera after you have deactivated Recording to SD Card and rebooted the camera. Failing to do so may lead to data loss! Make sure that the card is not write-protected!

2.8.1 Removing The MicroSD Card

1. **Deactivate recording:** Recording to MicroSD card must be deactivated (**Admin Menu > Storage on External File Server / Flash Device**). If MicroSD card recording is still active, deactivate recording and reboot the camera. Section 3.6 Micro SD Card Recording contains more information on this topic.

2. **Remove camera from the weatherproof housing:** Remove the two lock screws from the weatherproof housing and then remove the camera from the housing. In doing so, do not pull too hard on the lens cover. If required, use the long side of the 5 mm Allen wrench to carefully push the camera out of the housing from behind through the screw holes.



3. **Remove the connection cables:** The connected cables (patch cable, Mini USB, MxBus) must be removed from the camera first by rotating and opening the bayonet catch (see end of Section 2.2.2).



4. **Remove the back of the camera and take out the MicroSD card:** Remove the four screws from the back plate using the supplied 2.5 mm Allen wrench and carefully lift off the back plate. Gently push on the MicroSD card in the card slot of the camera. The card will be released from the slot and can then be removed from the camera.



Bayonet catch open



Push-push function: only remove the MicroSD card after first gently pushing it in



To use the camera without a MicroSD card, continue with step 2 in Section 2.8.2 (Mount the Back Plate).

2.8.2 Inserting The MicroSD Card

1. **Insert the MicroSD card:** Push the MicroSD card into the card slot as shown, until an audible and perceptible click indicates it is in place.



2. **Mount the back plate:** Replace the back plate of the camera housing, ensuring that the back plate screw holes are correctly positioned above the thread inserts.



3. **Screw the back plate tight and replace the connection cables:** Place the four Allen screws back into the back plate and tighten the screws using the supplied 2.5 mm Allen wrench. The previously removed patch cable must now be reconnected (see end of Section 2.2.2).



4. **Tighten the back plate:** Re-attach the camera to the weatherproof housing using the two lock screws. Make sure that none of the cables are damaged in the process.



5. **Activate recording:** If you have inserted a MicroSD card that has already been MxFFS formatted, you can activate recording under **Admin Menu > Storage on External File Server / Flash Device**. Once the camera has been rebooted, it automatically activates recording.
6. **If you have inserted a new MicroSD card,** it must first be formatted as described in Section 3.6 MicroSD Card Recording.

Push-push function:
insert the MicroSD
card and push it gently



Bayonet catch
closed



2.9 Network And Power Connection

2.9.1 Notes On Cable Lengths And Power Supply

- Power may only be supplied to the camera via its Ethernet connector. A MOBOTIX PoE adapter or similar high-quality PoE product is recommended to provide the power supply via the network cable (see Section 2.3 *Available M24M Accessories*):
 - one camera: with the PoE adapter (MX-NPA-PoE)**
 - multiple cameras: with PoE products conforming to IEEE 802.3af (PoE switch)**
- The **maximum length** of the network cable for power supply over an Ethernet cable is **100 m**.
- Make sure that you only use switches or routers that support the **10/100 Mbps Ethernet interface** of the camera. Check for LED activity on the corresponding port of the switch or router. When deploying several cameras, read the notes in Section 4.11 *Operating Multiple Cameras* in the *Software Manual*.
- It is highly recommend to use uninterruptible power supplies (UPS) to provide backup power.
- If you are using IEEE 802.3af Power over Ethernet network components to supply power to MOBOTIX cameras, make sure, if possible, that these components do not have a fan. Since the power consumption of MOBOTIX cameras is very low compared to other products, the reliability of the entire system is increased, thus extending the life of these components.

2.9.2 PoE Variables

The power consumption of the camera depends on the functions in use as well as any connected expansion modules (see table). PoE classes 1, 2 or 3 may be selected in the browser-based user interface in order to optimally adjust the camera to your system design (PoE switch in use, emergency power concept, etc.).

PoE power level classes (IEEE 802.3af standard):

Class	Max. Power Consumption	Possible Operating Modes
1	0.44 W – 3.84 W	Normal operation without audio output and without USB devices
2	3.84 W – 6.49 W (factory default)	Normal operation with audio output and with USB devices
3	6.49 W – 12.95 W	Like class 2 and also with MxBus devices

MOBOTIX
factory default
is class 2

The **MOBOTIX factory default is PoE class 2**. This default is usually fine and nothing needs to be changed. However, if the lower power level class 1 is sufficient for your application, it may – due to possible internal power distribution schemes amongst the ports of the PoE switch in use – be advantageous to change the PoE power level class in the browser:

Variable PoE: multiple cameras can be operated simultaneously from the same switch

1. Select **Admin Menu > Network Setup > Ethernet interface** (for experts).
2. Under **Power Supply**, click **Change**.
3. A **Power Wizard** will appear to guide you through the PoE configuration steps.
4. The camera will then need to be restarted via a hard reboot: Disconnect the camera from the power supply, then reconnect it, for example, by disconnecting and then reconnecting the network cable at the PoE switch.

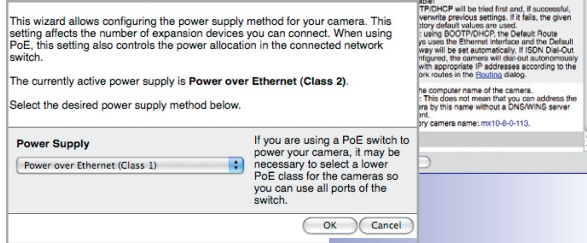
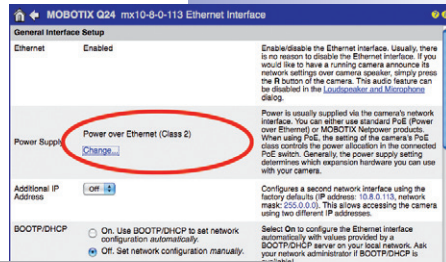

2.9.3 Power Supply Using A Switch

1. Connect the factory pre-installed cable of the camera to the **Camera** connector of the PoE adapter.
2. Connect the **LAN/Power** connector of the PoE adapter to the Ethernet connector of the switch/router or the Ethernet socket.
3. Plug the RJ45 connector of the power supply unit into the **PC/Power** connector of the PoE adapter.

The IP addresses in the diagram are shown only as an example

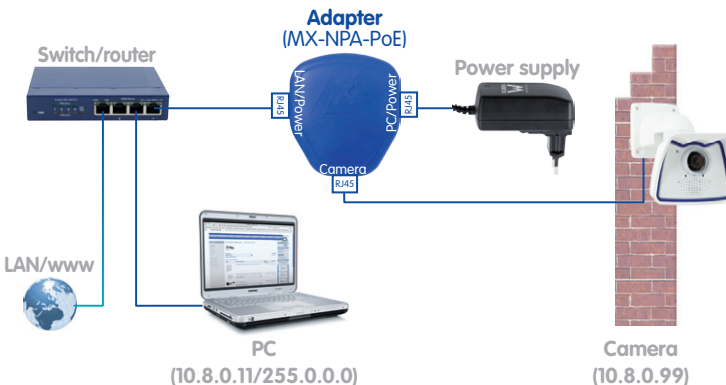

For the M24M, you should use the new blue MX-NPA-PoE-Set - previous MOBOTIX network power accessories such as the NPA Set, Power Box and Power Rack (MX-NPA-Set, MX-NPR-4 and MX-NPR8/20) are not suitable for use with the M24M



The IP addresses in the diagram are shown only as an example

For the M24M, you should use the new blue MX-NPA-PoE-Set - previous MOBOTIX network power accessories such as the NPA Set, Power Box and Power Rack (MX-NPA-Set, MX-NPR-4 and MX-NPR8/20) are not suitable for use with the M24M



2.9.4 Power Supply When Connected Directly To A Computer

1. Connect the factory pre-installed cable of the camera to the **Camera** connector of the PoE adapter.
2. Connect the **PC/Power** connector of the PoE adapter to the Ethernet port of the computer.
3. Plug the RJ45 connector of the power supply unit into the **LAN/Power** connector of the PoE adapter.

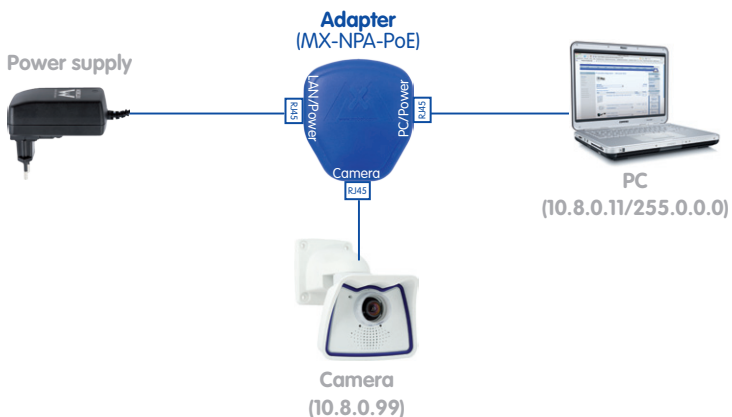

2.9.5 Power Supply (PoE IEEE 802.3af) Using Power Over Ethernet Products

Connect the factory pre-installed cable of the camera to the Ethernet connector of the PoE switch/router. The switch/router must support the PoE standard IEEE 802.3af.

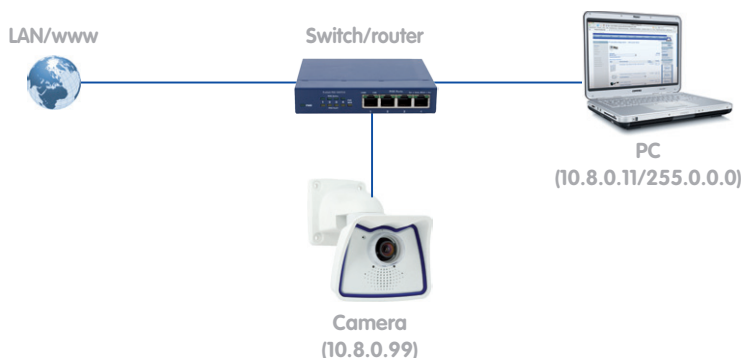

The IP addresses in the diagram are shown only as an example

2.9.6 Camera Startup Sequence

As soon as the camera's power supply has been established, the two LEDs will show the progress of the startup sequence (see Section 5.4.3 LED Signals and LED Configuration in the MOBOTIX Camera Software Manual Part 2).

- **Booting:** Immediately after connecting the power supply, the red LED lights up, blinks for two seconds, then stays on permanently red. A camera self-test is carried out at this point, and the entire system is started. In case of an error, the camera will start using the backup system.
- **Waiting for key pressed:** Both LEDs light up for four seconds. If you press the **R or L key of the camera** during this time, the camera will execute the corresponding function (see Sections 3.2.5 and 3.2.6 Starting the Camera with IP Address).
- **Ready:** Once the camera software has been started, the green LED is on permanently and the red LED blinks. You can now connect to the camera via the network using a browser.

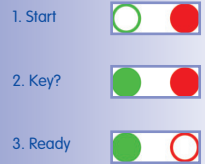

Notes

During the startup sequence of the camera, the LEDs will always light up, even if they have been deactivated in **Admin Menu > LED Setup**.

Download the free-of-charge MxEasy and MxControlCenter software at www.mobotix.com

Camera software in the browser

3 OPERATING THE CAMERA

3.1 Manual And Automatic Operation - Overview

MOBOTIX cameras do not require any extra software. Thus, you can set up and operate the MOBOTIX camera using a JavaScript-enabled browser on all common operating systems (such as Windows, Linux, Macintosh, etc.). As an alternative, you can also use the MOBOTIX applications MxControlCenter and MxEasy. Follow these steps to set up the camera:

1. **Connect the camera to the network.** Power is supplied directly via the network cable (see Section 2.9)
2. **Set up the camera's network parameters:**
 - **Manually using a Web browser** (see Section 3.2.1, then Section 3.2.2)
 - **Automatically using MxControlCenter/MxEasy** (see Sections 3.2.3 and 3.2.4) or **via DHCP** (see Section 3.2.5)
3. **Configure the camera** using the browser-based user interface, with MxControlCenter or with MxEasy.

Every MOBOTIX camera comes preconfigured with a fixed IP address in the 10.x.x.x range (for example, 10 . 8 . 0 . 99). However, local computer networks usually have IP addresses in the 172 or 192 ranges. In order to access a MOBOTIX camera via the network, the camera needs to obtain an IP address in the same address range. You can **set up the network parameters of the MOBOTIX camera using one of the following methods: Manually**, using MxCC and MxEasy or by DHCP.



3.1.1 Manually Using A Computer In The 10.x.x.x IP Address Range

You can set up the camera's network parameters using a browser and the embedded camera software. To do this, connect the camera to a computer or a network that is using a 10.x.x.x IP address range (see Section 3.2.1 *Manually Setting Up The Network Interface*). Once this has been completed, you can enter the camera's default IP address in the browser address bar of the computer (see Section 3.2.2 *The First Images And The Most Important Settings In The Browser*). Next, click on the **Admin Menu** button to open the camera's Quick Installation in the browser's user interface. This is where you can configure the desired network parameters of the camera. Once you have completed the Quick Installation, you can connect the camera with its new network parameters to the desired network.



The default IP address of your camera is printed on a sticker on the back of the camera

Advantages

- The camera does not need to be physically accessible, that is, it can remain mounted to a pole, for example.
- No additional software is required.
- The network parameters can be set flexibly through manual entry.

Disadvantages

- The computer or the network needs to operate in the 10.x.x.x IP address range or needs to be able to access such a network.
- The setup does not work automatically.
- You need to know the relevant network parameters.

3.1.2 Automatically Using MxControlCenter Or MxEasy

You can set up the camera's network parameters using the free-of-charge video management software MxControlCenter or MxEasy (see Sections 3.2.3 and 3.2.4). You can also use one of these applications to automatically configure the network parameters of MOBOTIX cameras that are not operating on the same IP address range as the computer.

MxControlCenter software (free download from www.mobotix.com)

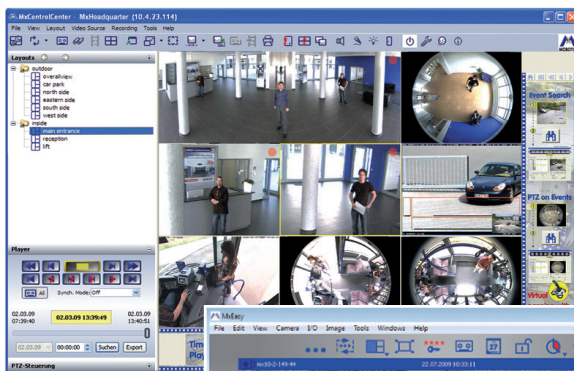

MxEasy (free download from www.mobotix.com)

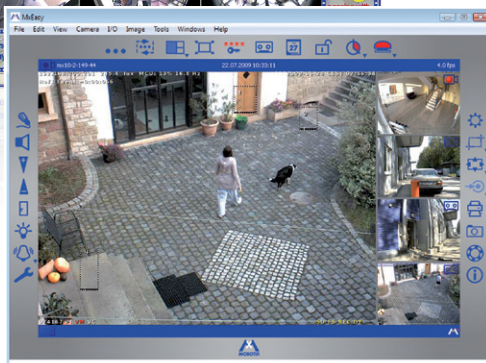

Advantages

- You can connect the camera directly to the target network.
- The camera does not need to be physically accessible, that is, it can remain mounted to a pole, for example.
- The camera can be configured to automatically receive an IP address (optional).
- The network parameters can be manually set (optional).
- You do not need to access the camera user interface.

Requirement

- The MxControlCenter or MxEasy video management software needs to be installed on the computer.

3.1.3 Automatically Using DHCP

The camera can automatically obtain its network parameters using DHCP. This requires the network to have a functioning DHCP server (for example, a DSL router with activated DHCP server) and the camera must be booted using DHCP (see Section 3.2.5 *Starting the Camera With an Automatic IP Address (DHCP)*). The IP address automatically assigned by the DHCP server will be announced via the camera speaker as soon as the camera has booted successfully.

Advantages

- You can connect the camera directly to the target network.
- Network parameters are automatically assigned.
- No additional software is required.
- You do not need to access the camera user interface.

Disadvantages

- The camera needs to be physically accessible as you need to press a key on the camera housing to boot it using DHCP.
- Requires a running DHCP server on the network.

Pressing the **R** key on the camera (see Section 2.9.6) prompts the camera to announce its current IP address over the speaker

3.2 First Images And The Most Important Settings

Once the camera has been connected to the network, you need to set up the camera's network interface accordingly. This step involves setting up and checking the network parameters of the camera. If your network is already using an IP address in the 10.x.x.x range with a 255.0.0.0 network mask, you do not need to change the camera's network parameters. You can access the camera directly (see Section 3.2.2). If your network or computer does not use an IP address in the 10.x.x.x range (for example, in the 192 or 172 ranges), you should follow one of the following methods for changing the camera's network parameters:

- **Manual Setup** (Section 3.2.1)
- **Automatic Setup using MxControlCenter or MxEasy** (Sections 3.2.3 and 3.2.4)

Notes

For the following examples, we will use a camera with the factory address 10.8.0.99. Replace this IP address with the IP address of your camera. You will find the IP address of your camera on a small sticker on the camera. Make sure that the IP addresses used in the following examples are not already being used by other devices in the network.

Hint: Pressing the **R** key on the camera (see Section 2.9.6) prompts the camera to announce its current IP address over the speaker.

3.2.1 Manually Setting Up The Network Parameters In A Browser

In order to manually set up the network parameters of the MOBOTIX camera, you need a computer that is using a 10.x.x.x IP address. The computer's network parameters usually have to be changed for this purpose.

1. Change the network parameters of your computer:

Windows (2000, XP and Vista):

1. Open **Start > Settings > Control Panel > Network Connections**. Clicking **Properties** opens the dialog shown.
2. Double-click **Internet Protocol (TCP/IP)**. On the **General** tab, activate the *Use the following IP address* option. Enter an IP address in the 10.x.x.x range in this field (for example, 10.8.0.11).
3. Once all dialogs have been closed, the computer will have the IP address 10.8.0.11.

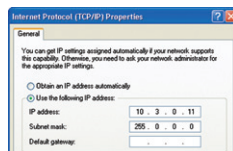
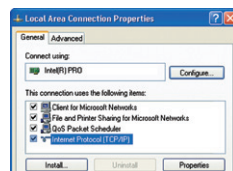

Caution:
Netmask 255.0.0.0

Linux/Unix:

1. Open a terminal as `root` user.
2. Enter the following command: `ifconfig eth0:1 10.8.0.11`
3. The computer is now also using the IP address 10.8.0.11

Mac OS X:

1. Open **System Properties > Network**.
2. Select **Ethernet**. In the **Configuration** field, select **Manual** and enter a 10.x.x.x IP address (for example, 10.8.0.11).
3. Click **Apply** on the bottom right-hand side of the dialog to assign the computer the IP address 10.8.0.11.

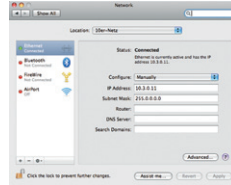

2. Set up the target network parameters of the camera:

1. Open a Web browser on the computer and enter the default IP address of the MOBOTIX camera in the address bar of the browser (for example, 10.8.0.99). Pressing Enter displays the user interface of the MOBOTIX camera (see also Section 3.2.2 *First Images And The Most Important Settings In The Browser*).
2. Click the **Admin Menu** soft key in the user interface of the MOBOTIX camera. The Quick Installation starts automatically once the *admins* user has logged on.
 Note: The Quick Installation can also be executed at a later stage by opening **Admin Menu > Network Setup > Quick Installation** (see also Section 5.2 *Quick Installation* in the *Camera Software Manual Part 2*).

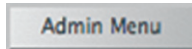

User Name: **admin**
 Password: **meinsm**

3. Enter the target network parameters of the camera on the appropriate page of the Quick Installation assistant.
 Note: The network parameters can also be accessed at a later stage by opening **Admin Menu > Network Setup > Quick Installation**.
4. Once you have completed the Quick Installation and rebooted the camera, the new network parameters will be activated. The camera can now be connected to the target network and, if required, further configured.



3.2.2 First Images And The Most Important Settings In The Browser

Once the MOBOTIX camera has been connected to the power supply and to the network, you can access the user interface with the live camera image in the Web browser. Internet Explorer, Firefox, Safari, Konqueror, Opera, Camino, or any other graphical browser with activated JavaScript is suitable. It does not matter which operating system is used.

After entering the camera's IP address in the browser address bar, you will see the live screen of the MOBOTIX camera with its user interface controls, such as soft keys, buttons for the different camera screens, pull-down menus (Quick Controls), symbols for accessing the online help and the camera status as well as status information elements above and below the live image.



Note

Default access data for the administration menu

User Name: **admin**

Password: **meinsm**

Camera Screens: Live, Player, MultiView

The MOBOTIX camera automatically displays the **live** screen when it starts up (factory default setting). You can set a different start page in **Admin Menu > Language and Start Page** (for example, the **Guest** screen) to allow a restricted access to the live image.

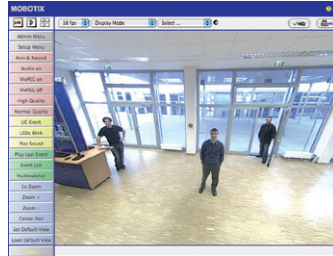

The other available standard screens include **Player** (playback of recorded images and video sequences) and the **MultiView** screen (displays several cameras with live or recorded images).

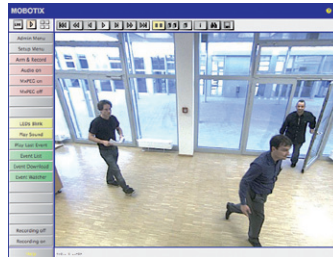

MultiView allows you to view several cameras via a "proxy" camera (especially useful if you want to access your cameras from outside of the network with reduced bandwidth) and the **PDA** mode provides a special screen for mobile devices.

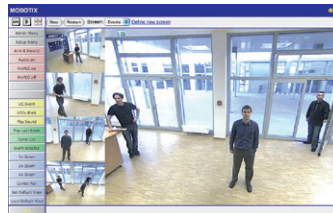

Note
For more information on camera screens, see Section 4.1.1 *Camera Screens in the Browser*, the *Camera Software Manual Part 2*, or the online help of the camera's browser interface.



Live screen:
<http://<camera IP>/control/userimage.html>



Player screen:
<http://<camera IP>/control/player>



MultiView screen:
<http://<camera IP>/control/multiview>

PDA screen:
<http://<camera IP>/pda>

PDA event list:
<http://<camera IP>/control/player?eventlist&pda>

Guest screen:
<http://<camera IP>/cgi-bin/guestimage.html>

Download MxControlCenter
for free from
www.mobotix.com

3.2.3 First Images And Network Parameter Configuration In MxControlCenter

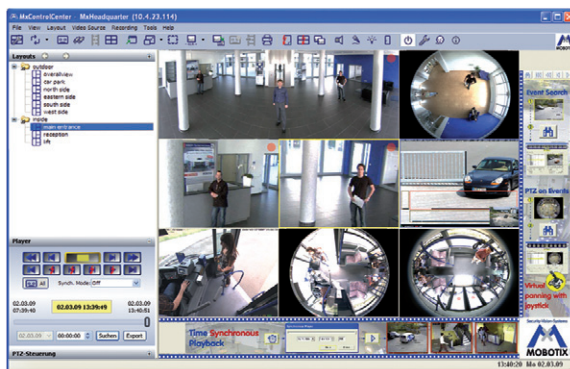

Installation

If you have an MxControlCenter installation CD, insert it into the CD/DVD drive of your computer.

If you do not have the installation CD or just want to install an update, you can download the latest Windows installer from the MOBOTIX website as an MSI file and install it manually. The latest versions are available at www.mobotix.com in the **Support > Software Downloads > MxControlCenter**.

If you insert the installation CD, the installation process will start automatically and you will be guided through the necessary steps. If you have downloaded the latest Windows installer, double-click the MSI file to initiate the installation process.

The Installer copies the selected files to the computer (older versions will be removed automatically) and then creates the designated shortcuts during the installation process (Desktop, Start Menu, etc.).

Caution

MxControlCenter will automatically attempt to find all MOBOTIX cameras in the physically connected network (that is, even a MOBOTIX camera with a factory IP address of 10.x.x.x). Make sure that the **firewall settings** on your computer are low enough so that MxControlCenter is not blocked. If MOBOTIX cameras are found, MxControlCenter can automatically reconfigure them so that they are available in the current subnet of the computer. If you do not have permission to modify these settings on your computer, contact your system administrator for assistance.

Searching And Displaying MOBOTIX Cameras

Launch MxControlCenter after successful installation (see section *Installation*) by double-clicking the shortcut that was created by the Installer or the executable `MxCC.exe` file in the installation directory on your computer.

When MxControlCenter is launched for the first time, the **Add Cameras: Search and Select** dialog opens and the application automatically searches for MOBOTIX cameras in the local network. To perform a camera search at a later time, select **Video Source > Add** from the menu.

If your MOBOTIX camera is properly connected, it should appear together with the existing video sources in the following list:

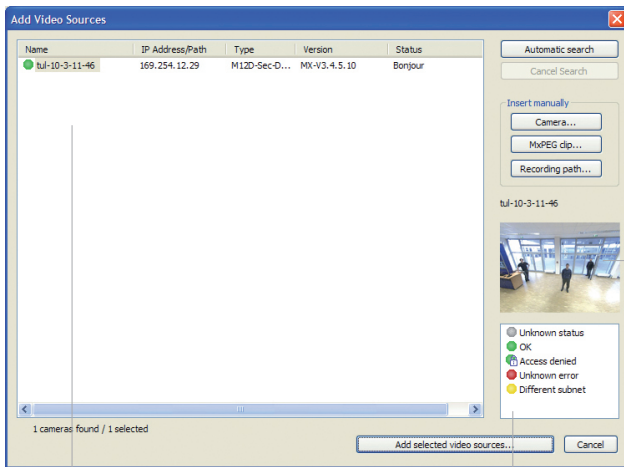

Automatic search for MOBOTIX cameras!

List of video sources



Legend

Camera preview

Note

Video sources in this context not only refer to MOBOTIX cameras, but also to third-party IP cameras, file server paths, MxPEG clips and analog cameras connected via MxServer (e.g. analog dome cameras). These video sources are not found automatically and need to be added manually.

Cameras Are Found But Are Located In A Different Subnet

The symbols in the first column and the legend in the dialog indicate whether you can access a particular camera directly from the MxControlCenter, which is the case for all cameras designated with  (OK). Cameras designated with  (different subnet) are located in a different subnet. This usually applies to new cameras or cameras that have been reset to their factory settings.

Note

MxControlCenter finds all MOBOTIX cameras, even when the computer and the cameras are not located in the same subnet.

Select the cameras that you would like to display in a Layout (a view with cameras) and click **Add selected video sources**.

The **Create new layout?** dialog will appear. You can choose to either create a new layout with the cameras that have been found or simply add those cameras to MxControlCenter.

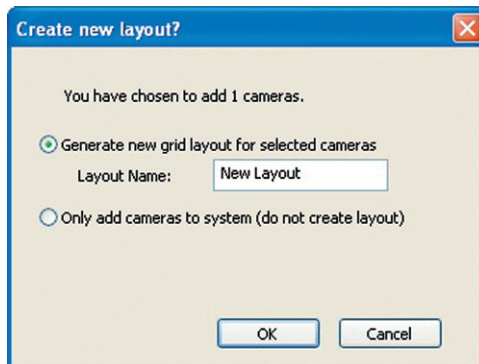

If some of the selected cameras are in different subnets, MxControlCenter displays the following dialog:

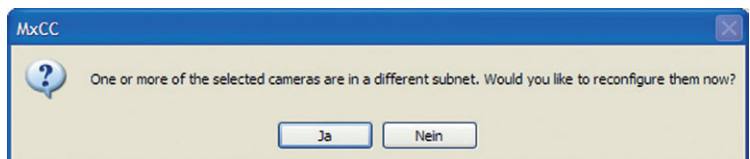

Click **Yes** to reconfigure the cameras for your specific network area.

Reconfiguring Cameras In A Different Subnet

In most networks, a **DHCP server** will automatically assign the IP addresses for network devices so that you can apply the default settings in the **Configure camera** dialog (**Get IP address automatically**). If you would like all cameras to obtain IP addresses automatically, select the **Apply to all selected cameras** checkbox.

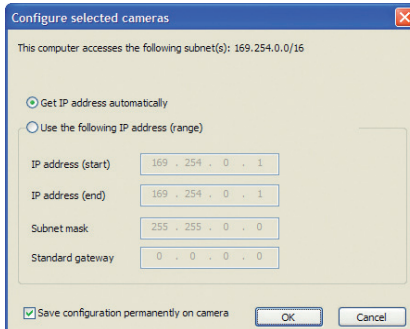

If the IP addresses for devices on the network are permanently assigned, ask your network administrator for the appropriate IP addresses for the cameras. Once you have that information, enter the correct **IP address** and **subnet mask** for each camera in the **Use the following IP address** option.

Make sure that the **Save configuration permanently on camera** checkbox is selected so that the cameras can be found at the designated IP address when you restart your computer.

Now wait until MxControlCenter has modified the network settings of the cameras and restarted the computer. The status of the reconfigured cameras changes from **(different subnet)** to **(OK)**. Confirm the **Open Video Sources** dialog again by clicking **OK**.

Defining Additional Video Sources

In addition to the MOBOTIX cameras that are found automatically, you can also manually add video sources to the list of video sources for MxControlCenter.

- **Camera:** Here, you can enter the known IP address or DNS name of an MOBOTIX camera or a third-party IP camera if it was not found by the automatic search feature.
- **MxPEG clip:** Adds an MxPEG video clip previously recorded by a MOBOTIX camera as a video source.
- **Recording path:** Adds the path of an external file server where a MOBOTIX camera has recorded audio/video data. The videos or images recorded at that location can now be played back using the **Player** or **Video Search**.

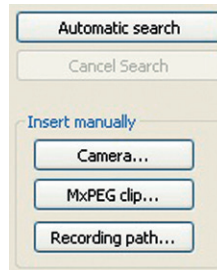

Selecting Video Sources

In this list you can now select the video sources that you would like to display and manage in MxControlCenter.

Camera Preview

If you select one camera with the status *OK*, MxControlCenter automatically displays the **live images from that camera in the preview window**. If you are using [Ctrl]-click to select additional cameras, the image from the camera selected last is shown in the preview window. This feature makes it easier for you to identify the cameras that you would like to use.



Editing The Video Source List

Right-click this list to open a shortcut menu from which you can select all video sources or cancel the selection. You can also use this method to remove from the list some or all of the video sources that you would not like to display or manage in MxControlCenter.

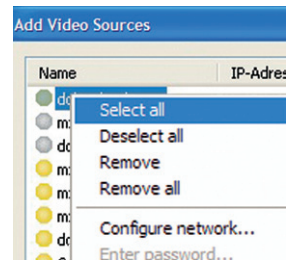

If you have cancelled the camera configuration process or need a password that differs from the camera's factory default password, you can also configure the camera from the shortcut menu at a later date and enter the user name and password required for reconfiguration at that time.

It is also possible to open the **Configure selected cameras** dialog using the shortcut menu in order to change the camera network parameters.

Adding Selected Video Sources In A New Layout

Click **OK** to add the selected cameras in MxControlCenter. If you select the **Generate new grid for selected cameras** option in the **Create New Grid Layout** dialog, MxControlCenter will automatically create a grid layout that displays all selected video sources in equal-sized windows.

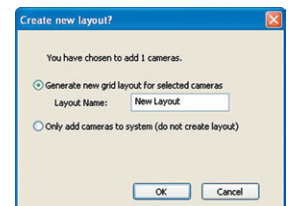

Otherwise, the selected video sources will only be added to the MxCC system and can then be used to create layouts at a later date.

3.2.4 First Images And Network Parameter Configuration In MxEasy

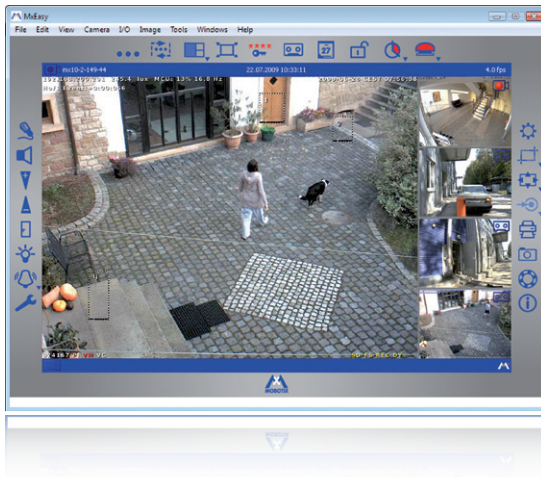

Installing MxEasy

If you have an MxEasy installation CD, insert it into your CD/DVD drive. The assistant will guide you through the installation process. If this is not the case or if you would like to update to a newer version, you can download the latest MxEasy version for your operating system from the MOBOTIX website (www.mobotix.com > Support > Software Downloads in the **MxEasy** section).

Using MxEasy For The First Time

To start MxEasy, double-click the shortcut or the program file itself.

Automated Search For MOBOTIX Cameras

If you start MxEasy for the first time on a computer, the Camera Selection dialog will appear, showing all detected MOBOTIX cameras. The camera list will be updated automatically as soon as new cameras are connected to or removed from the network.

MxEasy also automatically monitors and displays the operating status of all cameras. Cameras that are not on the same subnet as the computer will get a differently colored border than the cameras that are on the same subnet. Likewise, the cameras that

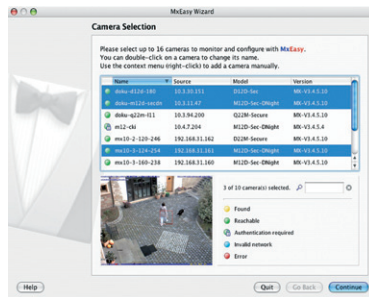

have an unknown password or for which no user name/password combination has been specified in MxEasy will be displayed in a different color.

If all the desired MOBOTIX cameras are highlighted as **Accessible** in the video source list, you can proceed to the *Selecting Cameras* section below. Cameras with the status **Invalid Network** can be reconfigured for the "proper" subnet, as described in the following section.

Configuring MOBOTIX Cameras For A Different Network

Camera found in a different network

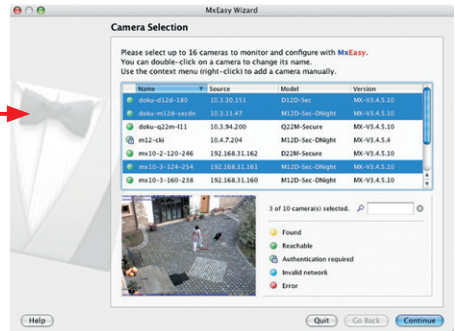

Using Bonjour, MxEasy finds not only cameras on the same network as your computer, but also MOBOTIX cameras located in other subnets (Status **Invalid Network**). In such a case, you would not be able to establish any connection to cameras in a different network or subnet (without going into much further detail about the specific details of TCP/IP network configurations). This is possible, for example, when a camera with a factory IP address is connected to a network in which a DHCP server automatically assigns the IP addresses. MxEasy can automatically configure such a camera so that it is "integrated" into your existing network. To do so, simply highlight the desired camera in the list.

Clicking **Next** displays a security prompt; if you click **OK**, the dialog for reconfiguring the selected camera will appear.

If your computer automatically obtains its IP address from a DHCP server, then this is certainly the best choice

for that specific camera and most likely for all other cameras that have been found in a different subnet (**Get IP address automatically** option).

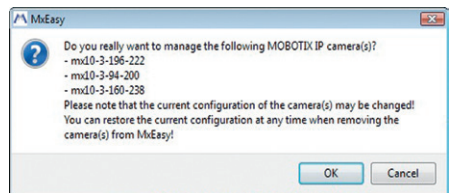

If you have assigned a fixed IP address to your computer, you will probably want to assign fixed IP addresses (issued by your system administrator) to every camera (the **Use this IP address** option). Here, for the most part, you should either enter a similar configuration as in the network settings of your computer.

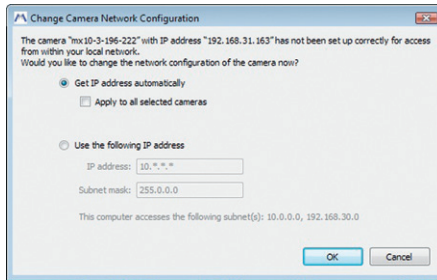

Once you click **OK**, the selected cameras will be reconfigured automatically. All reconfigured cameras will then be running in the same subnet as the computer and are displayed as **Accessible** in the camera list.

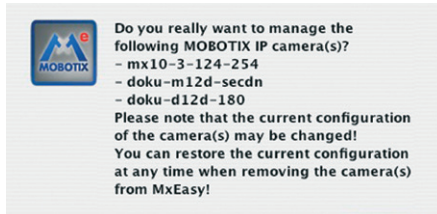

Selecting Cameras

You can highlight the cameras that you would like to display and manage in MxEasy. If you select a camera with the status **OK**, MxEasy automatically displays the live images from that camera in the preview window. If you are using [Ctrl]-click to select additional cameras, the image from the camera selected last is shown in the preview window.

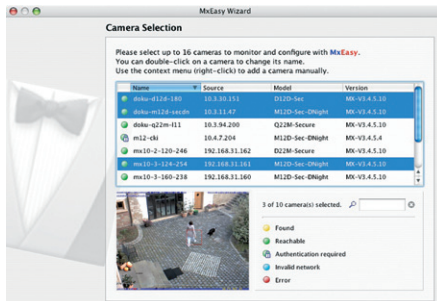

Editing The Camera List

Use the shortcut menu commands (right-click) to add MOBOTIX cameras to or remove them from the list. In addition, you can display further information of a camera and change the user name/password of a camera. For more information on this topic, see the MxEasy User Manual.

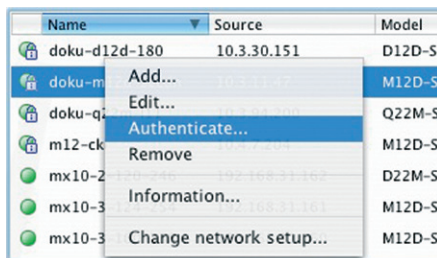

Download the latest MxEasy User Manual as a PDF file from www.mobotix.com

Using The Selected Cameras

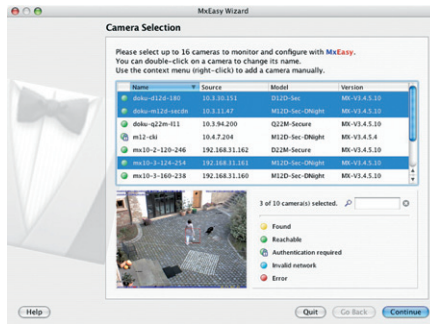

Clicking **OK** prompts MxEasy to use the selected cameras and to generate a screen with the live images of the four cameras that you selected first.

If MOBOTIX cameras with a hemispheric L11 lens are selected in the selection list, MxEasy Assistant displays the dialog shown here for each of the cameras. Here, you can determine the mounting position and the desired image view of each camera (wall or ceiling). The screens are displayed differently depending on the mounting position.

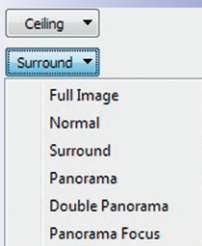
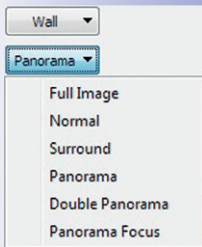

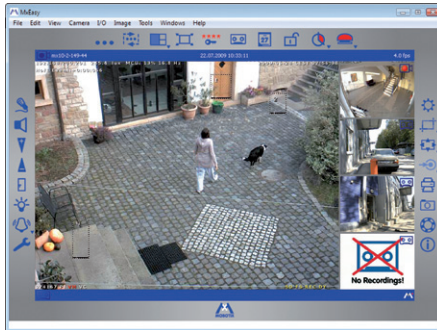

The panel at the bottom right-hand corner always displays the most recent event image of whatever camera is visible in the large panel. Double-click on a small camera panel to move this camera's live image to the large panel. Use **Cameras > Add Cameras** at any time to add MOBOTIX cameras to MxEasy (max. 16 cameras in total).

3.2.5 Starting The Camera With An Automatic IP Address (DHCP)

If your network has a DHCP server, you can start the MOBOTIX camera with DHCP support. In this case, the DHCP server automatically assigns and announces an IP address. Note that this announcement function can be deactivated (**Admin Menu > Loudspeaker and Microphone**).

Carry out the following steps to start the camera with a DHCP address:

1. If the camera is running, disconnect the camera's power supply.
2. Reconnect the power supply of the camera.
3. Wait until both LEDs light up simultaneously for the first time. Press the camera's **R** key within four seconds. Use a **paper clip**, for example, for this purpose but **avoid using sharp or pointed objects!**



4. After about two more seconds, the camera plays a sound ("Boing, Boing").
5. After about another 15 seconds, the camera will automatically announce its network data, that is, IP address, network mask and MAC address. You can now access the camera using the IP address it just announced.

Push the "R" key to announce the network data again

In case of an error, the camera uses its last IP address

Notes

Starting the camera with an automatic IP address (DHCP) is only **temporary**. The network configuration of the camera can be set to DHCP permanently under **Admin Menu > Ethernet Interface**.

Caution

When starting the camera with DHCP support, make sure that the network has a functioning DHCP server. If this is not the case, the camera cannot obtain a valid IP address and will use its last IP address.

You should also make sure that the cameras always obtain the same IP addresses by assigning the MAC addresses of the cameras to the desired IP addresses.

3.2.6 Starting The Camera With The Factory IP Address

Under certain circumstances, you may have to reset the camera to its factory IP address. This could be the case, for example, if the IP address has been lost or the camera does not respond to the last known IP address.

1. If the camera is running, disconnect the camera's power supply.
2. Reconnect the power supply of the camera.
3. Wait until both LEDs light up simultaneously for the first time.
4. Press the camera's **L key** within four seconds. Use a **paper clip**, for example, for this purpose but **avoid using sharp or pointed objects!**



5. After about two more seconds, the camera plays a sound ("Boing"). The camera is now accessible using its factory IP address (see label on the camera housing).

Notes

If you use the camera's **L key** to load the factory network configuration, this configuration is not automatically saved in the camera's flash memory. When the camera is next rebooted without using the **L key**, the last stored network configuration will be used. To permanently store the new network configuration in the camera's flash memory, open **Admin Menu > Store**.

Caution

As opposed to resetting the camera using **Admin Menu > Reset configuration to factory defaults**, the user information will not be reset if the camera is booted using the factory IP address.

Passwords and camera settings will not be changed!

Make sure you store the factory network configuration in the permanent flash memory!

Users and passwords will not be changed!

3.3 Virtual PTZ

The virtual PTZ function allows you to use a mouse or joystick to continuously zoom in on images from the selected video source and "virtually" move the enlarged image section within the entire image sensor area (see also Section 1.1).



USB joystick offers greater ease of use

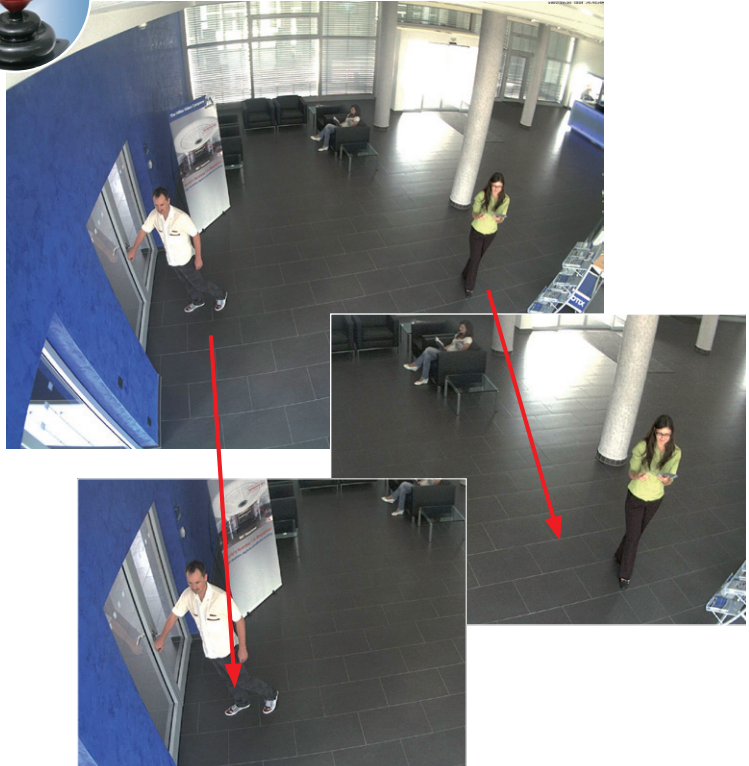

Operation Using The Mouse And Scroll Wheel

The vPTZ function of the M24M can be controlled in the browser using the mouse. By clicking any position on the image displayed on the monitor, this position becomes the new image center. The image moves and is corrected accordingly. The **scroll wheel** can be used to control the zoom function. This functionality is disabled in the default settings of the camera and must therefore first be activated. To do so, go to **Setup Menu > vPTZ Settings** and uncheck the **Lock Mouse Wheel Zoom** item. Then save the settings by clicking **Set** and **Close**. You can now use the scroll wheel to **zoom + (roll upwards)** or **zoom - (roll downwards)**.

Operation Using USB Joystick

A standard USB joystick can drastically improve vPTZ operation for the user – in the browser, in MxEasy, and in the MxControlCenter (however, MxCC is also equipped with a virtual joystick that can be operated using the mouse). Please first install the joystick on the PC according to the manufacturer's instructions.

In order to use a USB joystick in the browser, make sure that you have a PC with a Windows operating system and the latest version of Internet Explorer and that the **"ActiveX" mode in the camera software (browser) is activated:**

Virtual joystick in MxControlCenter

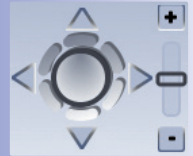

- Switch to **"Browser"** in the Quick Control.
- Under **"Browser,"** select the **"ActiveX"** option. The USB joystick can then be used until the browser is closed.
- To store the setting permanently, ActiveX must be activated in the **Admin Menu**. To do so, use **"Language and Start Page"** in the Admin Menu.
- Under the page options, select the **"ActiveX"** operating mode.
- Store the settings permanently by clicking **"Set"** and **"Close"** in the Admin Menu.
- The joystick can now be used.

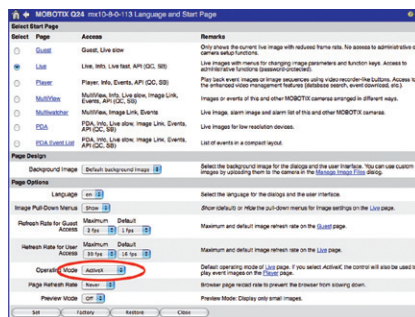
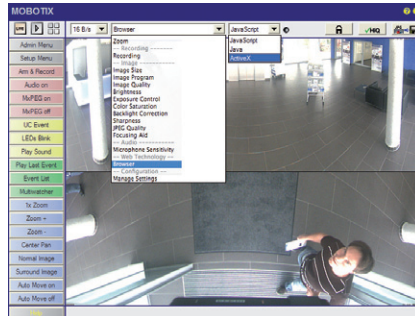

Notes

You will find more information and details on vPTZ in the **Camera Software Manual Part 2**, Section 4.3.6 (Virtual PTZ), the **MxEasy** manual, Section 2.4.1 (Activating the PTZ Features), and the **MxControlCenter** manual, Section 2.4.6 (Using the vPTZ Features) and Section 3.1.4 ("PTZ Controls" in the sidebar panel).

The latest versions of all manuals are available at www.mobotix.com, Support > Manuals.

3.4 Correction Of Lens Distortion (L22 Only)

If you are using an M24M with the **L22 90° Wide Angle lens**, the image, particularly the edges, may be slightly distorted due to the extreme angle of the lens.

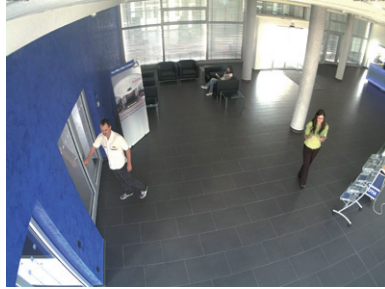

You can suppress this effect using software (for example, in the browser) so that a new and appropriately corrected image can be displayed live. A side effect of this correction, however, is that a cushion shape appears around the edges of the image.



To hide this cushion effect, you simply have to **zoom** in on the image slightly. Although this reduces the size of the captured area, the image is almost distortion-free compared to the original.

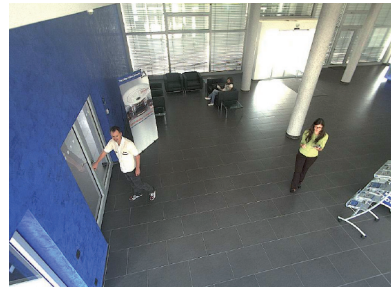

Since activated lens distortion correction requires additional processing power, you should consider disabling it in situations where it is not really necessary. You will only notice a minimal distortion of the image, especially if you use the zoom. However, the maximum frames rate for high resolution may be reduced, which means you have to choose between maximum distortion correction or maximum frame rate.

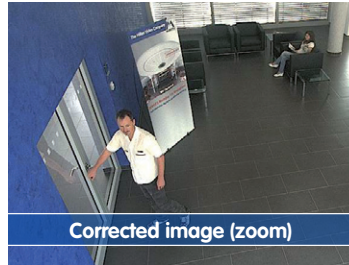
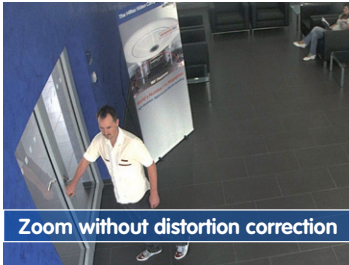

We recommend activating lens distortion correction, especially for applications with a low frame rate and non-zoomed images (for example, when using the M24M as a webcam). However, images can usually be corrected at a later point in time when searching recorded images. This saves on processing power during recording and increases the frame rate. The more you zoom in on the image, the less distorted the image should appear.

Activate/Deactivate Lens Distortion Correction In The Browser

To activate this option, first specify the lens you are using in the **Admin Menu > Camera Administration > Lens Configuration** dialog (this setting is saved until the camera is reset to its default configuration). Select the **"L22 (4.0 mm)"** option from the **"Lens Type Selection"** field and then click **"Apply"** followed by **"Restart."**

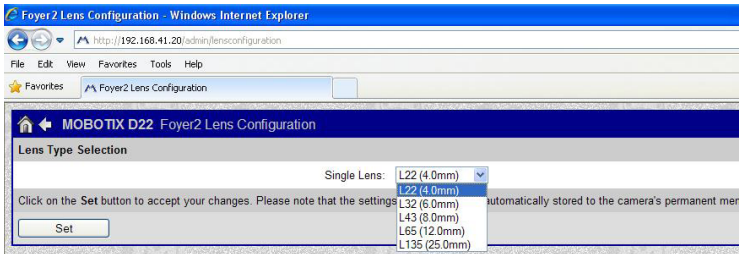

Now select the **"Lens Distortion Correction"** option in the **"Display Mode"** Quick Control panel. An automatically corrected (live) image is displayed that can be panned, tilted, or zoomed. Switching to the **"Full Image"** option will deactivate the automatic distortion correction function.

3.5 Special Hemispheric Configuration In The Browser (L11 Only)

Thanks to its hemispheric lens, the MOBOTIX M24M with L11 lens provides certain special configuration options for the image settings. Depending on where the camera is mounted (ceiling or wall) and on the live image display preferred by the user, certain important basic settings and, if necessary, their adjustment must be configured when an M24M is first installed.

To configure the M24M basic settings in the browser (without installing the software), carry out the steps described on the following pages:

1. **Log the camera on and boot it** as described in Section 3.2.
2. **Select mounting position wall/ceiling:** Click "Installation" in the Quick Control panel and then select "Wall" or "Ceiling" according to the position of the camera. "Ceiling" always means that the camera points from top to bottom.

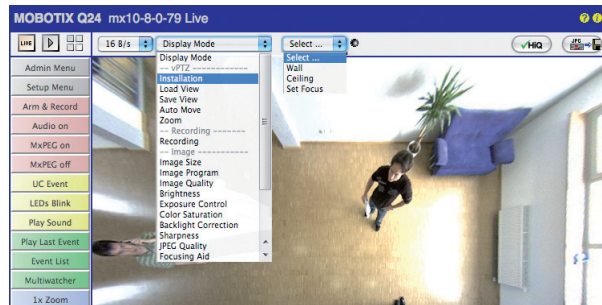

3. **Important:** After the camera has been installed, the "Installation" option can only be selected if "Display Mode" was set to "Normal" beforehand.
4. The result is a **corrected default view**. This serves as the basis for carrying out all vPTZ commands.
5. Then switch to the Quick Control "**Display Mode.**"
6. Set the mode that you want to be the standard view. For demonstration purposes, the descriptions below describe the typical display mode for the wall mount and the ceiling mount, "Panorama" and "Surround" respectively. Every other display mode can be operated in the same way.

Default settings:
Mounting position "Wall,"
"Panorama" screen

Wall Mount: Setting And Correcting The Standard View "Panorama"



Camera live image with panorama correction

1. In the Quick Control "**Display Mode**," select the option "**Panorama**." Examine the image that is now displayed. If the section meets your expectations, no further adjustment is necessary, and panorama configuration is complete. To change the image section to meet your specific expectations, continue with step 2.

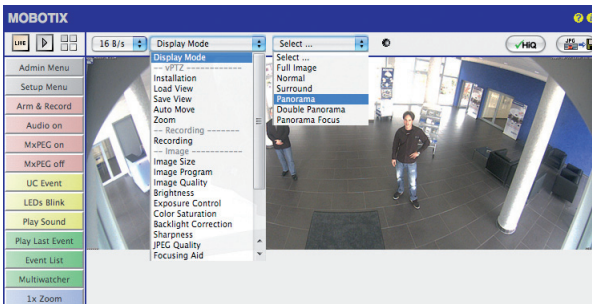

Camera live image without panorama correction with Quick Controls visible

Note

The currently visible image section may differ from the desired image section, to the installation position or the weatherproof cover, for example. However, it is not necessary to physically move the camera, as in this case the browser alone can be used to adjust the visible panorama image by zooming, panning, and tilting or using panorama correction.

Tilted vertical lines may also be optically straightened to the image edges using the panorama correction function. These tilted lines are primarily caused if the camera itself is tilted or if the image tilt has been modified.

- Click on the **lock icon**. Clicking the lock once opens it (lock clasp is raised). The lock prevents execution of later vPTZ actions, and thereby also unintentionally modifying the view you configure. This holds for all overview display modes, that is, also for Panorama Focus, Double Panorama and Surround.



Lock open

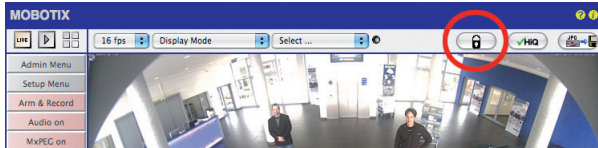

- A new **icon for processing the panorama image** appears in the top left corner of the camera image. Enlarge the image by clicking on the icon once (OnScreen Control appears).

Click on the icon

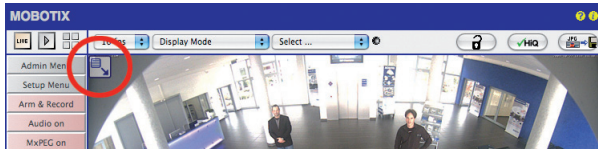

- Using the **OnScreen Control** visible in the live camera image, you can now change the displayed live camera image as desired (panning, tilting, zooming, horizon and panorama correction; see page on the right). When doing so, the vPTZ function using the mouse or joystick is deactivated.

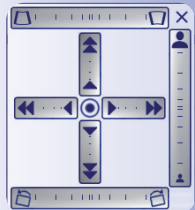

Camera live image with panorama correction with OnScreen Control visible

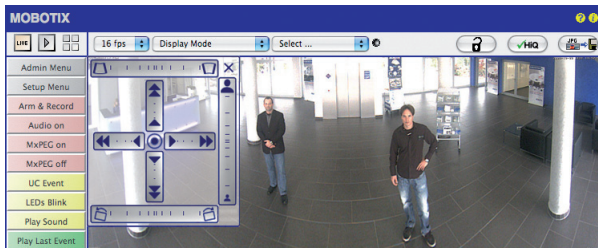

- When you have modified the desired setting, close the control panel (x in the top right hand corner).
- Click on the lock icon again** to close it (lock clasp is down). The panorama image setting is then locked until the camera is next restarted.

Caution

To permanently save the standard image setting defined for the M24M, select the **"Store Complete Configuration"** option under the **"Manage Settings"** in **Quick Control**. The settings will then remain in effect, even after rebooting.

Using The M24M OnScreen Control:

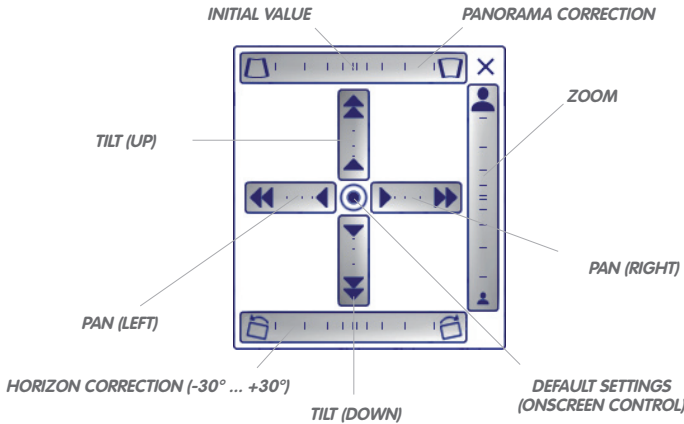

You can set the OnScreen Control by clicking the individual areas (panning, tilting, zooming, panorama and horizon correction) in two different directions with the mouse. Each area is represented by a horizontal or vertical bar with a central point. **The further away from this central point that you move the mouse, the greater the change triggered.** Clicking the central point of the cross leads directly to the default setting of the OnScreen Control.

The **horizon correction** feature causes the **entire image to rotate between the range of -30° to +30°** and should, if required, be used before panorama correction.

During **panorama correction**, clicking between the two trapezoid symbols **straightens the left or right tilting vertical lines**, which are best visible at the edges of the image section.

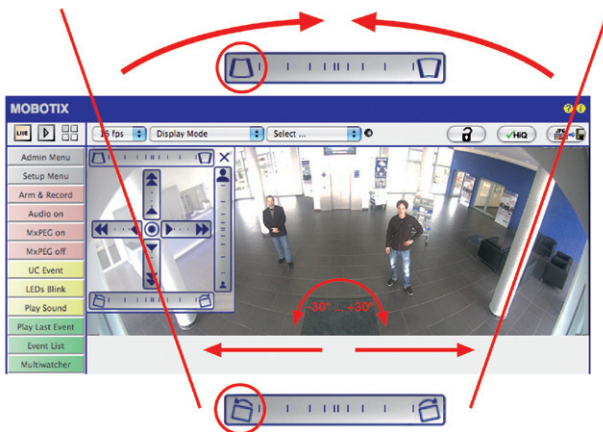

HORIZON CORRECTION

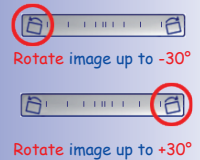

PANORAMA CORRECTION

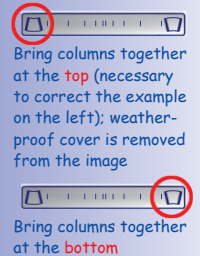

Ceiling-Mounted: Set North (User-defined North Direction)

If the camera has been mounted to a ceiling, the M24M should be set to "North." This is not the "real" direction of North but rather the **main line of sight or the focus** of the camera. It serves as a reference for the North direction in the **"Surround"** and **"Double Panorama"** display modes (you have already selected the **"Ceiling"** option in the **"Installation Type"** Quick Control).

1. In the Quick Control **"Display Mode,"** select the **"Normal"** option.

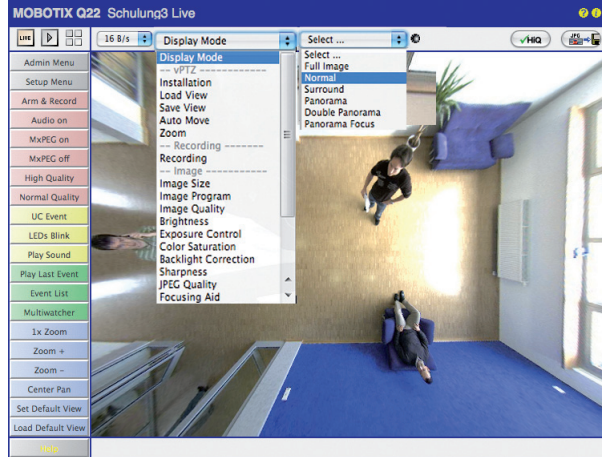

For vPTZ use and the configuration of a USB joystick, see Section 3.3

2. **Rotate the live image** in the desired direction using the mouse or a joystick connected to the computer.

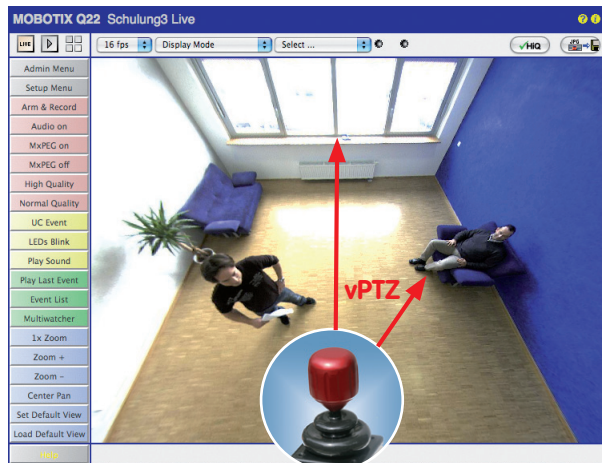

- In the Quick Control **"Installation,"** select the **"Set North"** option.

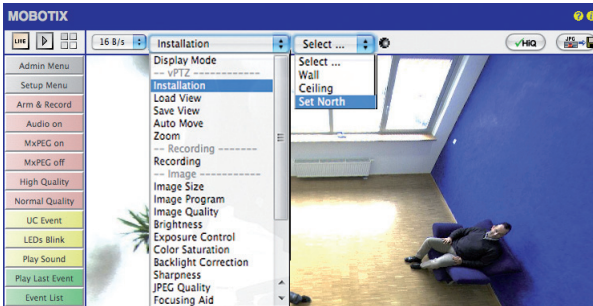

- Store the desired North direction permanently by first activating the checkbox and then clicking "Yes."

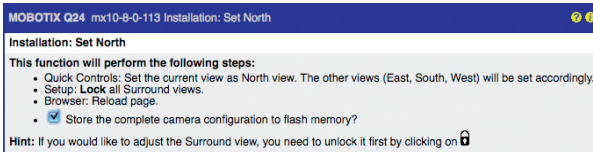

- You have now set the North direction for the display mode "Surround" and "Double Panorama." In the next step, you can set these views as the standard view for the camera live image. In the Quick Control **"Display Mode,"** select the **"Surround"**



or **"Double Panorama"** option. You can fine-tune the views using vPTZ via mouse or joystick and, as described above, by unlocking and locking the standard view using the lock icon (open lock - correct display - close lock again).

Caution: No OnScreen Control is available in "Double Panorama" mode

More reliable than
hard drives: flash
memory devices

3.6 MicroSD Card Recording

3.6.1 Introduction

Flash-based storage devices (MicroSD cards, CF cards, USB sticks, and solid-state drives) do not contain any moving parts as compared to the commonly used hard drives. Flash-based devices are compact, extremely resistant to humidity and shock, use very little energy, do not lose data during power failures, and are becoming less expensive. They are thus ideally suited for use with MOBOTIX cameras.



Number Of Write/Delete Cycles Per Flash Storage Cell

The number of write/delete cycles of every storage cell of a flash device is limited (for example, 10,000, 100,000 or more, depending on the quality). The controller of the flash device automatically detects individual flash cells that are no longer functioning. The contents of the faulty cell will then be rebuilt using a checksum and will be moved to a properly working spare cell. The faulty storage cell will be marked as "bad" and will no longer be used. No data is lost in this process.

In addition, MOBOTIX cameras constantly monitor activated flash storage devices. MOBOTIX has developed a technology to test the wear of the flash device by logging the number of write/delete cycles (patent pending). The flash memory wear is automatically displayed in the status bar in the live camera image but it can also be viewed at anytime in the **Admin Menu > Camera Status** dialog.

Conservative Memory Usage Thanks To MOBOTIX MxFFS File System

MxFFS formatting of the MicroSD card means that the MOBOTIX camera software will use the flash device as evenly as possible, thus allowing for the maximum possible number of write/delete cycles. This also means that all storage cells of the flash device will be written and deleted with the same frequency, if possible. The MOBOTIX technology increases the life of the flash device considerably and also improves the security and the reliability of the storage process.

Storage Requirements And Life Expectancy Of MicroSD Cards

The life expectancy of a MicroSD card increases proportionally to the storage capacity, since the camera software will execute fewer write/delete cycles on each storage cell. The first deletion will begin once the SD card has been filled to capacity (first full cycle). The theoretical life expectancy of a 16 GB MicroSD card is between 10 and 35 years, depending on the degree of use.

MicroSD Card Recording

32 GB MicroSD Card: Storage Requirements and Life Expectancy						
	6 fps CIF		6 fps VGA		1 fps Mega	1 fps QXGA
	M-JPEG	M-JPEG	MxPEG	M-JPEG	M-JPEG	
File size single image	15 kB	45 kB	-	120 kB	240 kB	
Storage required per second	90 kB	270 kB	75 kB	120 kB	240 kB	
Storage required per 24 hrs	7.8 GB	23.5 GB	6.5 GB	10.4 GB	20.8 GB	
Time for one full cycle	4 days	1.3 days	4.8 days	3 days	1.5 days	
Est. theor. life expectancy	60 years	20 years	73 years	46 years	23 years	

4 GB MicroSD Card: Storage Requirements and Life Expectancy						
	6 fps CIF		6 fps VGA		1 fps Mega	1 fps QXGA
	M-JPEG	M-JPEG	MxPEG	M-JPEG	M-JPEG	
File size single image	15 kB	45 kB	-	120 kB	240 kB	
Storage required per second	90 kB	270 kB	75 kB	120 kB	240 kB	
Storage required per 24 hrs	7.8 GB	23.5 GB	6.5 GB	10.4 GB	20.8 GB	
Time for one full cycle	12 hours	4 hours	14.4 hours	9.2 hours	4.4 hours	
Est. theor. life expectancy	7.6 years	2.5 years	8.8 years	5.6 years	2.8 years	

All specifications are based on calculated averages

Caution

It is recommended to use only high-grade MicroSD cards that are new.

For security applications, it is highly recommended to exchange the MicroSD card for a new one after one year of operation.

Monitoring The Cell Wear Of Flash Storage Devices (Patent Pending)

MOBOTIX uses its own technology for this purpose and has a pending patent. You can view the flash wear in the status bar of the live image or by opening **Admin Menu > Camera Status**. In addition, the camera can send a warning message (for example, via e-mail) if the flash cell wear reaches a critical value (**Admin Menu > Storage on External File Server / Flash Device**). This leaves enough time to exchange the MicroSD card before the danger of data loss becomes too high.

File Server / Flash Device	
Type	SD Flash Card
File System	MxFFS
Flash Wear	1%
Transfer Buffer Usage	0% (0: 0%, max: 0%)
Lost Event Images	0
Sequences	1 (1 files)
Newest Sequence	1970-01-01 01:00:00 #0
Oldest Sequence	1970-01-01 01:00:00 #0
Current Usage	4.0 MBytes (0.4%)
Max. Size	936 MBytes

Formatting the card:
Admin Menu > Storage on
External File
Server / Flash Device

The *Safe Format* option
takes several hours. You
can also use suitable
applications on Windows,
Linux/UNIX and
Mac OS X computers
to safely format the
MicroSD card

3.6.2 Formatting The Card

Before a MOBOTIX camera can store image and video sequences on a MicroSD card, it needs to be formatted as MxFFS (MicroSD cards delivered with MOBOTIX cameras are already MxFFS-formatted). The following steps are necessary to format a storage device (**Admin Menu > Storage on External File Server / Flash Device**):

1. Make sure that there is a MicroSD card in the card slot of the MOBOTIX camera.
2. Click on the **Format** button under **SD Flash Card**.

3. Select the *Quick Format* option and confirm by clicking **OK**.

Note: In contrast to the *Quick Format* option, the *Safe Format* option will make sure that the data on the MicroSD card is overwritten completely so that the data cannot be recovered in any way. However, keep in mind that the *Safe Format* takes considerably more time.

4. Enter the user name and the password of a user of the *admins* group in the dialog that opens and click on **OK** to confirm. The MOBOTIX camera now starts formatting the card. It usually takes between 5 and 12 minutes to format an 8 GB MicroSD card using the *Quick Format* option and 3 to 14 hours using the *Safe Format* option.

External USB Harddisk MxFFS Format...

Formatting Options

Depending on the nature of the data currently stored on media **SD Flash Card**, you can choose how thorough the formatting process should be.

Formatting Mode:	Quick Format will simply write new administrative data structures, leaving most of your data on the device. The data will not be accessible again for regular use, but they could be reconstructed. Safe Format will overwrite all bytes on the device with a defined pattern, thus removing all of your data. Note, that this mode will be considerably slower.
<input checked="" type="checkbox"/> Quick Format	
<input type="checkbox"/> Safe Format	
<input type="button" value="OK"/> <input type="button" value="Cancel"/>	

Authentication Required

WARNING

You are about to **erase all data on device Internal Flash Memory** by reformatting it in MxFFS mode. You are therefore once again required to provide **admin-level authentication** below.

User Name	admin
Password	*****
Really proceed with formatting and erasing device Internal Flash Memory?	
<input type="button" value="OK"/> <input type="button" value="Cancel"/>	

Once the formatting has been completed, you can activate the MicroSD card for recording (see next section).

Caution

Make sure that you always wait until the formatting process has been completed before accessing the camera again. This usually takes only a few minutes when using the *Quick Format* option! You can only access the MicroSD card once MxFFS formatting has been completed!

The *Safe Format* option can take several hours. You can also use suitable applications on Windows, Linux/UNIX, and Mac OS X computers to safely format the MicroSD card.

3.6.3 Activate Recording

Follow these steps to activate the recording to a MicroSD card that has already been MxFFS-formatted (**Admin Menu > Storage on External File Server / Flash Device**):

1. Make sure that there is a MicroSD card in the card slot of the MOBOTIX camera.
2. Make sure that the MicroSD card has been MxFFS-formatted (see Section 3.6.2 *Formatting the Card*).
3. Activate the **SD Flash Card** option.
4. Click **Set**, then **Close** to store the configuration.
5. Reboot the camera (**Admin Menu > Reboot Camera**).
6. Once the camera has rebooted, make sure that the camera displays the **FR REC** symbols in its live image. If this is the case, the camera uses the MicroSD card as recording target. If not, you can activate the recording (see below).

Activating The Recording

If the symbols **FR REC** are not visible in the camera's live image after rebooting, you need to activate the recording using one of the following methods:

- **In the Web browser:** Automatic activation by clicking the **Arm & Record** soft key. Confirm this in the Easy Dialog by clicking **Yes**.
- **In the Web browser:** Manual activation via the Quick Control **Recording > Recording on** or in **Setup Menu > Recording**.
- **MxEasy:** You can use the MxEasy's Alarm Planner feature to activate recording based on time and date (see also Section 2.5 *Setting Up Alarms and Recordings* in the *MxEasy User Manual*).

Activating Encryption And Authentication

If security is an issue, you can opt to store only encrypted video data on the MicroSD card. If you would like to use encryption, make sure that you activate this option when formatting the card. Note that you also need to enter an authentication password. Switching from encrypted to unencrypted storage (and back) is not possible without reformatting the card.

Activating the storage device: **Admin Menu > Storage on External File Server / Flash Device**

This feature will be available in future software versions

3.6.4 Accessing Camera Data

The following options facilitate access to the stored image and video sequences on a MicroSD card:

- **In the Web browser:** Play back the recorded event images without audio directly from the MicroSD card using the Playback view of the camera software.
- **In MxEasy:** Play back the recorded video sequences with audio by accessing the MicroSD card in the MOBOTIX camera via the camera.
- **In MxControlCenter:** Play back the recorded video sequences with audio by accessing the MicroSD card in the MOBOTIX camera via the camera or with a direct access to the MicroSD card via a card reader connected to the computer. Access the card by setting the MicroSD card's drive/volume as a "directory" in MxControlCenter.

If the MicroSD card's contents are encrypted, you need to enter the corresponding password before you can access the recorded video data. A dialog will automatically appear in MxControlCenter or MxEasy.

Caution

When using the MicroSD card from one MOBOTIX camera in another MOBOTIX camera, you need to make sure that the time on the original camera is in sync with the new camera. It is recommended to use automatic time synchronization via a time server (**Admin Menu > Date and Time**).

3.6.5 Deactivating The Card Memory

Follow these steps to deactivate the memory on a MicroSD card (**Admin Menu > Storage on External File Server / Flash Device**):

1. Activate the **None** option.
2. Click on the **Set** button at the bottom of the dialog and then **Close**.
3. Reboot the camera (**Admin Menu > Reboot Camera**).
4. Once the camera has rebooted, make sure that the symbol `FR REC` is no longer visible in the bottom right-hand corner of the live image.
5. You can now safely remove the MicroSD card from the camera (see Section 2.8.1).

Caution

A **MicroSD card may only be removed from the camera after you have deactivated Recording** to MicroSD Card and **rebooted the camera**. Failing to do so may lead to data loss!

Removing connected flash storage devices from the camera without properly deactivating them may lead to data loss and/or destroy certain areas of the storage device. Due to MxFFS formatting, this is limited to 4 MB of lost data per incident.

3.6.6 Using A MicroSD Card In A Different MOBOTIX Camera

A MicroSD card containing recorded video data from a MOBOTIX camera can be inserted into any MicroSD card-enabled MOBOTIX camera. Once MicroSD card recording has been activated (requires a reboot), the "new" MOBOTIX camera automatically synchronizes with the card and resumes recording. No data is lost in this process. Make sure that you deactivate MicroSD card recording before removing the card and reboot the MOBOTIX camera!

If the MicroSD card's contents are encrypted, you need to enter the correct password in the "new" camera in the **Admin Menu > Storage on External File Server / Flash Device** dialog. Otherwise, the camera cannot access the MicroSD card.

3.6.7 Limitations On Warranty When Using Flash Storage Devices

MOBOTIX will not assume any responsibility for flash storage devices (for example, MicroSD cards or connected USB storage devices) delivered with or integrated into MOBOTIX cameras. The same applies to damage to flash storage devices or damage resulting from the use of devices that are not supplied by MOBOTIX.

3.7 Full Image Storage

It is possible to store a **full image**, regardless of the live image stream that is being displayed. This ensures that the recording always contains the full image of the lens used, even though the operator may have used the vPTZ features to zoom into the image in order to examine a specific detail.

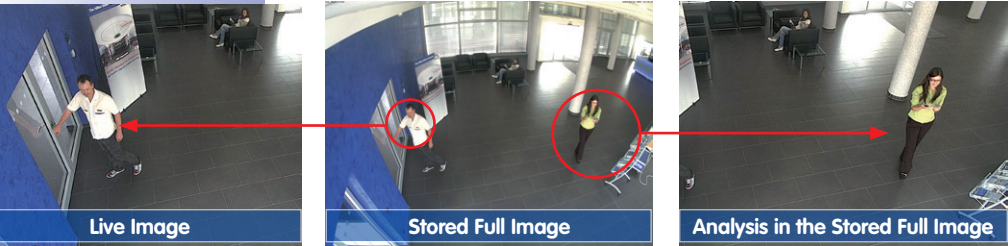

This means that you can use the vPTZ features in VGA resolution to pan, tilt and zoom the live image while the camera is for example, recording full images at 1 fps in MEGA or QXGA resolution.

In **MxEasy** or **MxControlCenter**, the recorded full images may be prepared for the user with the vPTZ functions (for example, panning and zooming in on an image detail such as a doorway).

If **full image storage is not activated**, only the last displayed live image will be saved (save what is seen). The **main benefit** of live image storage is to ensure that the full power of the camera processor is used for live image correction and maximum frame rates.

The **main advantage of full image storage** lies in the special functionality of the M24M, in that it can always maintain availability of a maximum size (full) image for later searches, despite vPTZ actions carried out on the live image. The mechanical limitations of motor-driven PTZ cameras mean that they simply **cannot** provide this unique advantage to the user!

The image distortion caused by the **L22 90° Wide Angle lens** can be corrected (see Section 3.4). Since this function requires more computing power, it should not be enabled in the live image for applications that require a maximum frame rate. The image distortion in the recording can also be corrected at a later time.



Recommendation
when using L22 lens

Activate/Deactivate Full Image Storage In The Browser

To configure this feature, open the **Setup Menu > Event Control > Recording** dialog and activate or deactivate the "Full Image Recording" option.

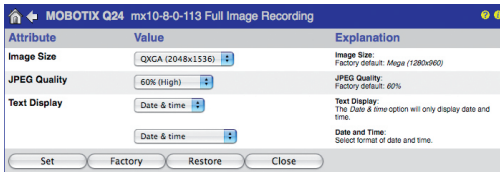
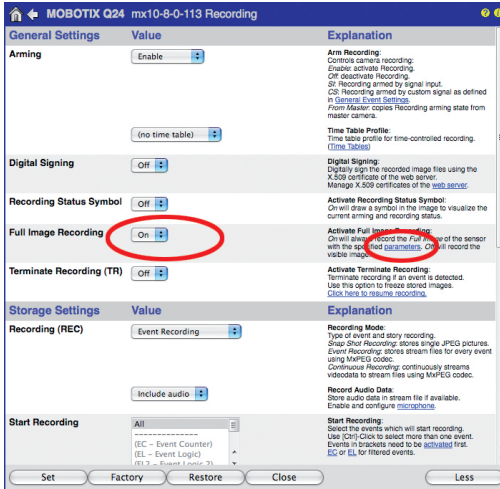

Notes

Post-event search in the full image: If you are using Full Image Recording on M24M cameras, you should use at least MEGA resolution when storing. This will facilitate later searches in **MxControlCenter** or **MxEasy**. The advanced distortion correction features require this function to deliver satisfactory image quality.

Full Image Recording On: Due to its increased computing power, full image recording reduces the data rate of the live image stream, which may drop by about 10 to 30 percent. It is therefore recommended to reduce the frame rate for storage as much as possible, so as to affect the live image stream as little as possible.

Full Image Recording Off: The event that triggered a video motion (VideoMotion VM) window may not be in the recorded sequences as the window was not displayed at the time.

3.8 Configuration In The Browser



3.8.1 Overview

A MOBOTIX camera can be completely configured using a JavaScript-enabled browser on all common operating systems (such as Windows, Linux, Macintosh, etc.). The camera provides a HTML-based user interface for this purpose. The camera executes the changes you make to the camera configuration via HTTP commands using programs and scripts of the embedded software. The settings are stored in the camera's flash memory.

This section contains an overview of the general browser settings of the MOBOTIX camera, as well as further configuration options. The Software Camera Manual Part 2 contains more detailed descriptions of the software features.

3.8.2 General Browser Settings

- **Run the Quick Installation:** After booting the MOBOTIX camera for the first time, accessing the administration menu (**Admin Menu** button) will automatically start the Quick Installation. The Quick Installation assistant helps you in setting the most important parameters of the camera. For security reasons, you should set your own administrator password and disable public access to the camera.

=> (*Software Camera Manual Part 2, Section 5.2*)

- **Disable public access:** Guest users are only allowed to access the Guest screen of the camera without entering a password. If this is not desired, you should deactivate public access (**Quick Installation** or **Admin Menu > Users and Passwords**).
=> (*Software Camera Manual Part 2, Section 5.4.1*)
- **Add users and assign access rights:** Similar to a computer operating system, you can add users and user groups and assign the desired rights (**Admin Menu > Users and Passwords, Admin Menu > Group Access Control Lists (ACL)**). This approach allows individual access rights to be assigned or denied to camera-specific features based on the user groups.
=> (*Software Camera Manual Part 2, Section 5.4.1*)
- **Deactivate the automatic reboot:** In its factory state, every MOBOTIX camera will automatically reboot every morning at 3:36 a.m. All images in the camera's storage buffer will be deleted during this reboot. Images stored on external file servers, internal flash storage, or SD cards will NOT be affected by this reboot. Make sure that you deactivate the automatic reboot if this is not desired (**Admin Menu > Time Tasks**).
=> (*Software Camera Manual Part 2, Section 7.9.2*)
- **Optimize the image settings:** The factory image settings of MOBOTIX cameras deliver excellent images for most application scenarios and should not be changed. If you do wish to make changes, your changes should be minor and gradual. You should, however, set an image program according to the application scenario of the camera. Image programs provide a quick and simple method for adjusting the camera to the application scenario as they perform several configuration steps at once (**Image Programs Quick Control**).
=> (*Software Camera Manual Part 2, Section 5.5.2*)
- **Set the resolution of the live image:** By factory default, all MOBOTIX cameras are delivered with an image resolution of 640 x 480 pixels. You can select the desired resolution using the **Resolution Quick Control**.
=> (*Software Camera Manual Part 2, Section 4.3.3*)
- **Adjust the exposure:** The automatic exposure control of the MOBOTIX camera uses individually configurable windows to determine the best image exposure. Open the **Exposure Control Quick Control** and select a predefined set of exposure windows. If required, you can also define custom exposure windows (**Setup Menu > Exposure Settings**).
=> (*Software Camera Manual Part 2, Section 5.7*)

- **Activate event control and recording:** By factory default, the MOBOTIX camera's event control is disabled. Click on the **Arm & Record** button to activate event control. This will activate video motion detection and recording. Cameras with integrated flash memory (MOBOTIX R models and models with SD card) will use the flash memory by default to store the image and video data (recording target). If desired, you can set additional events and adjust the settings of the recording and storage parameters (**Setup Menu > Event Settings, Setup Menu > Recording** and **Admin Menu > Recording to External File Server / Flash Device**).

=> (*Software Camera Manual Part 2, Chapter 7 and Chapter 8*)

- **Set up actions/messaging:** Upon detecting an event, the MOBOTIX camera can trigger alarms. These alarms can be adjusted to your needs and you can assign them to one or more events: playing back an alarm sound on the camera speaker, showing the visual alarm in the camera live image, sending an e-mail or network message with the alarm image, placing a phone call, uploading an alarm image to an FTP server, switching a signal output line of the camera (for example, for switching on the lights/opening a door). To change the corresponding settings, refer to the following dialogs: **Setup Menu > Actions, Setup Menu > Messaging** and **Messaging 2** and **Setup Menu > Enhanced Signal Out Options**.

=> (*Software Camera Manual Part 2, Chapter 7*)

3.8.3 Additional Configuration Options

- **Administering the camera:** You can modify the camera configuration in the Administration menu or the Setup menu.
- **Admin Menu:** This menu contains the basic configuration dialogs of the camera (for example, passwords, interfaces, software updates).
- **Setup Menu:** This menu contains the dialogs for configuring the image, event, and recording parameters. Some of these settings can be changed using the corresponding Quick Controls in the live screen.
- **Resetting changes:** If you would like to reset some larger changes in one dialog without resetting the complete configuration, you can use the **Default** button at the bottom of the dialog to reset only this dialog's settings to the factory defaults. If you would like to reset all image settings, you can do so using the **Manage Settings > Restore Image Settings** Quick Control in the live image of the camera.
- **Storing changes permanently:** Once you have finished configuring the camera, you should always store the settings in the camera's permanent memory. You can do so in each dialog (clicking on the **Set** button at the bottom of each dialog will temporarily implement the change; when you click **Close**, you will be asked to store the complete configuration in the camera's permanent memory) or in the Admin Menu (**Admin Menu > Store current configuration into flash memory**). The **Configuration** section of the Administration menu provides more functions for storing, copying, and managing camera settings. For more information on this topic, see Chapter 5 *Basic Camera Configuration* in the *Camera Software Manual Part 2*.
- **Time tasks and time synchronization:** Apart from a multitude of possibilities for controlling the camera using time (time tables, holidays and vacations, scheduled tasks, etc.), the camera can also synchronize its internal clock. This allows you to manually synchronize the camera with a computer or automatically using a time server or another MOBOTIX camera. The camera can use either NTP time servers or Time Protocol servers. For additional information, see Section 5.4.2 *Date and Time/ Time Zones and Time Servers* in the *Camera Software Manual Part 2*.
- **The "More" and "Less" buttons:** When opening some of the camera dialogs, the camera only shows the most important parameters. These dialogs have a **More** button in the bottom right-hand corner; click it to display additional options. If all options are displayed, click on the **Less** button to hide the additional options.

User Name: admin
Password: meinsm

Admin Menu

Setup Menu

Make sure to permanently store changed parameters!

Automatic time synchronization using a time server

More: Display advanced features

Less: Hide advanced features

3.9 Additional Notes

3.9.1 Protecting The Camera Against Condensation

Due to its robust and carefully constructed design and the lack of mechanical moving parts, the M24M has some outstanding weatherproof features and is resistant to moisture and dust. Certified according to the **IP66 standard**, the camera is even resistant to water jets but is **not completely airtight**. Installation environments that experience **frequent changes in temperature and humidity may cause condensation to occur and build up** in the cavities of the camera mount through which outside air flows.

Condensation is caused when the temperature of warm moist air, which can absorb less water in a cooler state, falls below dew point. The condensation is the water that condenses when it meets the cool surface of an object.

To prevent condensation from building up, MOBOTIX recommends **drilling a hole corresponding to the size of the space in question** -only- the lower of the two positions pictured here and breaking through the outermost housing wall before mounting the camera (see next page).

Before drilling, separate the camera from its housing by removing the two Allen lock screws in order to prevent damage occurring to the camera or the cabling.

Use 2 mm drill bit



Before drilling,
remove the camera
from the housing



Depending on the later tilt of the camera, drill through the front or rear drain hole of the camera's weatherproof housing.



Camera tilted upwards: Drill through **rear** drain hole

Camera tilted downwards: Drill through **front** drain hole

When cleaning the camera with a water jet, do not use high-pressure cleaners. The drain holes should be sealed with adhesive tape during cleaning.

3.9.2 Password For The Administration Menu

Accessing the Administration menu of the camera (Admin Menu soft key) is only possible after entering a user name and password.

- Factory default user name is **admin**
- Factory default password is **meinsm**

The Quick Installation assistant automatically appears when the Administration menu is accessed for the first time. It provides an easy method to adjust the basic camera settings to the current application scenario. For security reasons, it is highly recommended to change the default administrator password after the camera has been properly configured.

Enter the user name and password exactly as shown above. Note that all entries are case-sensitive.

Caution

Make sure that you store information on **user names and passwords** in a secure place. If you lose the administrator password and cannot access the Administration menu, the password can only be reset at the factory. This service is subject to a service charge!

The microphone can be irreversibly deactivated!

3.9.3 Permanently Deactivating The Microphone

Deactivating a camera's microphone may become necessary in order to protect the privacy of persons at a workplace or for other reasons. You can permanently and irreversibly deactivate the microphone in the **Admin Menu > Loudspeaker and Microphone** dialog.

Caution

This **deactivation is permanent and cannot be reversed** even by MOBOTIX engineers. Deactivating the microphone will also deactivate all features that use the camera's microphone.

3.9.4 Starting The Camera With The Factory IP Address

If the camera's IP address is not known, you can start the camera with its factory IP address. Section 3.2.6 *Starting the Camera with the Factory IP Address* describes this procedure in more detail.

3.9.5 Reset The Camera To Factory Settings

All settings of the MOBOTIX camera can be permanently reset to the factory default settings. This makes sense if you have, for example, obtained a camera without any information or you would like to reset all settings after testing the camera. In order to perform this procedure, you need to have access to the Administration menu of the camera (admins group). Open **Admin Menu > Reset** to reset the camera to factory defaults.

Note

All defined users will be deleted and the admin password will be reset to the factory default when you reset the camera using **Admin Menu > Reset**. If you want to maintain existing users, use the method described in Section 3.2.6 *Starting the Camera with the Factory IP Address*.

3.9.6 Activate Event Control And Motion Detection

In its default configuration, the camera's event control and video motion detection features are not enabled. In order to activate event-controlled recording, open **Setup Menu > General Event Settings** and activate the Arming switch. Another method is to click the **Arm & Record** soft key in the browser's user interface. The camera displays the video motion detection window in the live image (dotted frame in the center) and the camera automatically stores images as soon as the video motion window detects movements.

The configuration can also be reset partially

If the dotted rectangle in the live image is visible, the camera is armed

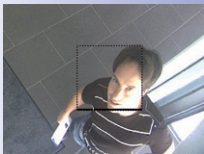

Text and logos can also be deactivated or customized

3.9.7 Deactivate Text And Logo Options

As the camera arming is deactivated in its default configuration (see preceding section), the MOBOTIX camera only displays the Text **WWW.MOBOTIX.COM**, the time stamp, and the MOBOTIX logo at the top of the image. Once the camera arming has been activated, the text at the bottom of the live image (event, action, messaging, and recording symbols) will also appear.

You can deactivate the status bar at the bottom of the live image and the text bar in the top left corner by setting **Text Display** in the **Setup Menu > Text & Display Settings** dialog to *Off*. Setting **Text Display** to *Date & Time* will only display the time stamp in the live image.

To hide the logo in the live image, open **Admin Menu > Logo Profiles** and set **Logo Display** to *Disable*.

3.9.8 Deactivating The Daily Automatic Camera Reboot

By factory default, the MOBOTIX camera automatically reboots every morning at 3:36 a.m. The reason for this is that in some rare cases external influences (for example, radiation in high locations) can lead to camera malfunctions. The automatic reboot will refresh the camera's memory and will ensure proper operation without requiring any interaction on the part of the user. If desired, you can deactivate the automatic reboot of the camera in the **Admin Menu > Time Tasks** dialog.

3.9.9 Browser

Current Internet browsers (Internet Explorer, Netscape, Firefox, Safari, Camino, Konqueror, Opera, etc.) with enabled JavaScript can display the camera's live images with their standard settings. Text-based browsers (for example, lynx) cannot display the user interface and are not suitable for operating the camera.

Section 4.1.3 *Browser Settings* in the *Camera Software Manual* contains more detailed information on possible browser problems.

3.9.10 Cleaning The Camera And Lens

If the lens becomes dirty during the installation process, clean the lens using a lint-free cotton cloth. Make sure that the lens is still in focus after cleaning and adjust its focus if required.

Cleaning The Lens Cover:

- In order to protect the lens cover from being scratched and from getting dirty, only handle it using a soft cotton cloth.
- You should clean the lens cover at regular intervals. Always use a soft, lint-free cotton cloth for this purpose.
- If the dirt is more persistent, add a mild alcohol-free detergent without abrasive particles.
- Make sure you instruct cleaning personnel on how to clean the camera.



3.9.11 Safety Warnings

Electrical surges can be induced by other electrical appliances, improper wiring, but also from the outside (for example, lightning strikes to phone or power lines).

MOBOTIX cameras are protected against the effects of small electrical surges by a range of measures. These measures, however, cannot prevent the camera from being damaged when stronger electrical surges occur. Particular care should be taken when installing the camera outside to ensure proper **protection against lightning**, as this also protects the building and the entire network infrastructure.

MOBOTIX recommends having MOBOTIX cameras **installed** only by specialists accustomed to installing network devices and who have proper respect for the pertinent regulations lightning protection and fire prevention, as well as the current technology for preventing damages from electrical surges.

Due to the high computing power of the M24M and the corresponding environmental conditions at the installation site, the **temperature** of the sensor board may rise to a relatively high level. However, this does not affect the functionality of the camera. The lens should not be touched directly during live operation.

Additional Notes

3.9.12 Additional Information

For more information, see the News and Functional Overview pages in the online help of the camera's browser interface. Click on the  symbol to open the camera's help section.

Furthermore, detailed information on the camera and its current configuration is displayed in the Camera Status dialog. Click on the  symbol to open the relevant page.

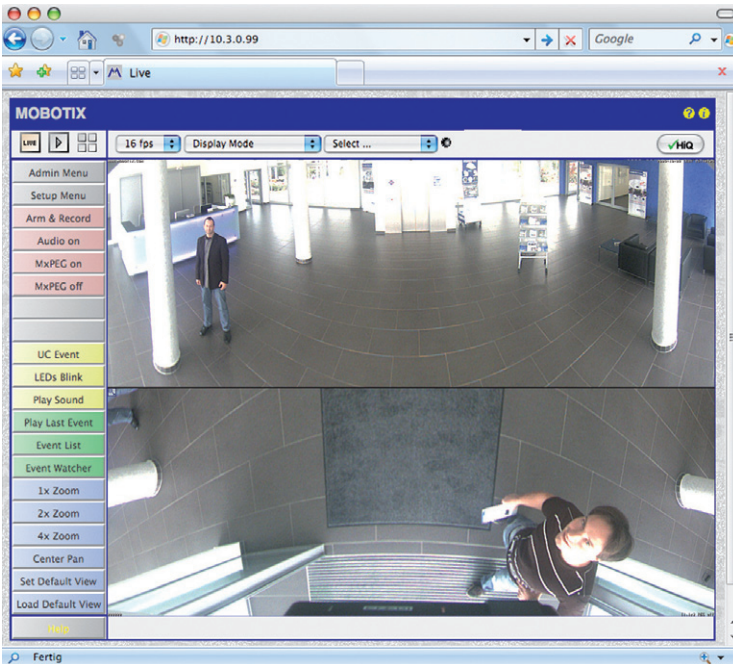

MOBOTIX GLOSSARY

ActiveX

Control element on Windows computers which may also be used in other programs (including Windows Internet Explorer) to run special tasks. The MxPEG ActiveX control element allows video and audio data from MOBOTIX cameras to be displayed in other applications (including Internet Explorer).

Arming

This refers to the process of activating an alarm system so that events trigger the appropriate alarms. Traditional alarm systems can be armed using a key switch or by entering a code on a keyboard. MOBOTIX cameras can be armed using a „software switch.“

Assistant

Refers to a software component that helps the user install or set up a particular program and guides the user through the configuration process by means of simple questions.

Auto Grid

Automatically generated grid used for displaying the live images from all cameras.

Bonjour

(French for "hello") is a technology developed by Apple based on the Zeroconf protocol, which is a method to automatically recognize network services on IP networks. For example, you can find a printer or a network camera on the local network without knowing the exact IP address of the device you are looking for.

CamIO

MOBOTIX signal module that the camera uses to directly operate lamps, sirens and access controls, as well as external audio components (speakers and microphones).

CCTV

Abbreviation for Closed-Circuit Television. A television system in which the analog video signal is only transmitted to monitors (for example, a building). The term CCTV is often used for video surveillance systems.

CF Card

Abbreviation for Compact Flash Card. An ultra-compact, digital (random access) memory device based on Flash memory modules and commonly used as a storage medium for digital cameras.

CIF, 2CIF, 4CIF (in accordance with PAL TV standard)

Common Intermediate Format. Corresponds to 1/4 TV image with 288 rows and 352 pixels (0.1 megapixel). 2CIF (1/2 TV image) has the same small number of rows (288), but 704 pixels (0.2 megapixel). 4CIF corresponds to the image quality of a traditional TV image with 576 rows and 704 pixels (0.4 megapixel).

CMOS Sensor

Abbreviation for Complementary Metal Oxide Semiconductor Sensor. Sensor for energy-efficient digitalization of image information. CMOS sensors are used as image sensors in digital cameras.

DevKit

Camera installation kit with independent image sensors based on MOBOTIX M12D or M22M, intended for concealed installation in other devices.

DHCP

Abbreviation for Dynamic Host Configuration Protocol. Allows a server to automatically assign devices in the network with the appropriate configuration (including the IP address, DNS server and gateway), as opposed to fixed IP addresses on the individual network devices.

DNS

Abbreviation for Domain Name Service. Allows the domain names of servers on the Internet (e.g. www.mobotix.com) to be linked ("resolved") to their corresponding IP addresses (e.g. 212.89.150.84).

Dome Camera

Most often refers to cameras with a round and compact design. The lens can be freely positioned and is protected by a transparent dome-shaped plastic housing.

DSL

Abbreviation for Digital Subscriber Line. Denotes a fast Internet connection capable of providing bandwidth of up to 16 Mbps for a typical household.

DualDome

Dome camera with two lenses and image sensors such as the MOBOTIX D12D. These lenses can deliver Wide Angle and Telephoto images independently of one another.

DVR

Abbreviation for Digital Video Recorder.

DynDNS

Abbreviation for Dynamic DNS (or DDNS, Dynamic Domain Name Service). Similar to DNS, this links domain names (e.g. mydomain.com) with IP addresses, whereby the IP addresses may change at any time. This service provides a convenient method to access your MOBOTIX cameras from home or work if the camera Internet connection is not through a router that assigns a fixed IP address, but instead over a DSL connection with a dynamically assigned IP address from the provider. A well-known provider of this (free) service is www.dyndns.org.

Ethernet

The most common technology for communication within a wired network. It facilitates data exchange between all devices (computers, printers, IP cameras, etc.) connected in a local network (LAN).

Events

An event refers to a situation when something happens or changes. In terms of video surveillance, this means a change in the status of an area that is being monitored. This may be movement of a person, a change in brightness, a drop in ambient temperature, the detection of a noise via a microphone, an electrical signal at a signal input, the manual operation of a button, etc.

ExtIO

MOBOTIX signal module that the camera uses to directly operate lamps, sirens and door openers, as well as external audio components (speakers and microphones).

Fixdome

Camera without moving parts in a dome-shaped housing.

Flash Memory

See CF Card.

fps

Abbreviation for frames per second. See Frame Rate.

Frame rate

The frame rate specifies how many frames per second (fps) are generated and sent by the camera. The human eye perceives movement as a fluid video sequence when more than 12 image per second are produced.

HDTV

Abbreviation for High Definition TV.

HiRes

Abbreviation for High Resolution. Refers to high-resolution images (above 1 megapixel).

Image compression

Image compression reduces the file size of an image. This is particularly important when transferring and saving files.

Image processing

Digital image processing. The goal is to correct errors made during image generation (caused by overexposure, underexposure, blurring, weak contrast, image noise, etc.) in order to create a „better“ image.

IP Network

Data network based on the Internet protocol (TCP/IP).

IP Telephone

See VoIP.

JPEG

Abbreviation for Joint Photographic Experts Group, responsible for the development of the JPEG standard method for image compression. JPEG is the most common lossy image format for photos on the Internet. Loss in image quality is barely noticeable at compression rates between 99% and 60%.

Latency

Time interval elapsed between the time an image is captured by a camera and when that same image is displayed on the monitor.

Layout

Describes the layout of video sources on a screen in MxControlCenter. When displaying images

from network cameras, the layout determines the positions and resolutions of the images displayed on the monitor. In addition to the actual video images, you can also incorporate graphic elements such as the location of the cameras, etc.

LED

Abbreviation for Light Emitting Diode. An electronic semiconductor component built into MOBOTIX cameras and add-on modules that emits light when a current flows through the component in the correct direction.

Linux

Free and open source operating system. Serves as the operating system for all MOBOTIX cameras.

Megapixel

Images that have more than 1 million pixels.

MonoDome

Dome camera with one lens, such as the MOBOTIX D24M.

Motion Detection

Action of sensing a movement within a particular area. MOBOTIX cameras use algorithmic methods to detect changes from image to image in predefined areas, while taking preset conditions into account. If a camera detects a movement, it signals an event and triggers an alarm.

Motion JPEG (M-JPEG)

A video compression method where each individual image is compressed separately as a JPEG image. Unlike MPEG, the quality of M-JPEG recordings is not dependent on movement within the image.

MPEG

Motion Pictures Expert Group. Standard for compressing and saving image and video data, resulting in quality loss. Originally created for playing entertainment content on PCs, MPEG concentrates on displaying still image material and compromises the quality of moving image material in order to increase the transmission speed.

MxControlCenter

MOBOTIX video management software for professional control of medium-sized and large camera networks.

MxEasy

MOBOTIX video management software for small and compact camera networks of up to 16 cameras.

MxPEG

MOBOTIX-developed method for compression and storage of image and video data with minimal network load and high image quality. The MxPEG ActiveX control element allows video and audio data from MOBOTIX cameras to be displayed in other applications (including Internet Explorer).

NAS

Abbreviation for Network Attached Storage, a storage system connected via an Ethernet cable. All network devices (cameras) have access to this storage system.

Network

A group of computers that are connected via various cables and share access to data and devices such as printers and IP cameras.

PIR

Passive Infrared Sensor for motion detection.

PoE

Power over Ethernet. A technology for supplying network-enabled devices (e.g. IP cameras) with power via the Ethernet data cable.

PTZ

Abbreviation for Pan/Tilt/Zoom. Refers to the movement of a video camera to the left and right, up and down, and to the camera's ability to enlarge an image.

Quad Display

Layout in which the images from four cameras are displayed in one window.

Resolution

Indicates the number of pixels used to produce an image. The more pixels an image has, the greater the detail when the image is enlarged. The resolution is expressed as the number of pixel columns times pixel rows or as a total number of pixels. A VGA image has 640 columns and 480 rows (640 x 480 pixels), which equals 307,200 pixels or approximately 0.3 megapixels.

RoHS

Abbreviation for Restriction of Hazardous Substances Directive and refers to EC Directive 2002/95/EC, which prohibits the use of certain hazardous substances when manufacturing products and components. The goal of this directive is to prevent these substances from harming the environment when the products are disposed of later.

Router

Network device that connects multiple networks with one another. The router establishes a physical connection between the devices in different networks (like a hub), analyzes the relevant data packets and forwards ("routes") these packets to the correct target network.

SD Card

SD Memory Card (Secure Digital Memory Card). A digital storage medium based on Flash storage modules such as USB sticks.

Search

Monitoring of recordings or searching for a particular event.

Sequencer

Feature that automatically switches the camera displayed in the main window after a specific time delay.

Signal Input/Signal Output

Coupling a system that triggers an alarm (for example, a fire alarm system or a network camera) to a control center or another type of transmitter (for example, a telephone or IP network). A typical signal input/output scenario in video surveillance progresses as follows: an event triggers an alarm. This alarm then display the video image from the network camera that triggered the alarm on the monitor at a control center. Snapshot Photograph of a situation created spontaneously and directly with a mouse click.

SIP

Session Initiation Protocol. Network protocol for setting up, controlling and terminating a communication connection via a computer network. SIP is frequently used in conjunction with IP telephony.

Switch

Hardware used to connect multiple network devices (computers, cameras, printers, etc.) within a network. A PoE switch can also supply the cameras with power over an Ethernet cable.

UPS

Uninterruptible Power Supply. Refers to devices that continue to supply power in the event of a sudden power failure. These devices usually operate using a battery. UPS is installed on the power lines of devices and systems in order to protect them in the event of a power failure.

VoIP

Voice over IP. Telephony using computer networks.

WLAN

Wireless Local Area Network. Used to provide Internet connections without the need for cables.

DECLARATION OF CONFORMITY

Konformitätserklärung
Declaration of Conformity
Déclaration de conformité

Hersteller: MOBOTIX AG
Manufacturer:
Fabricant :

Produkt: Netzwerk-Kamera
Product: Network camera
Produit : Caméra de réseau

Typ: M24M
Type:
Type :

Bei bestimmungsgemäßer Verwendung erfüllt das bezeichnete Produkt die Bestimmungen der im Folgenden aufgeführten Richtlinien:
 The product identified above complies with the essential requirements of the relevant standard, when used for its intended purpose:
 Le produit désigné ci-dessus est conforme aux exigences fondamentales des normes s'y rapportant :

Niederspannungsrichtlinie 2006/95/EG
Low-voltage directive
Directive basse-tension

Angewendete harmonisierte Normen: EN 60950:2005
Harmonised standards applied:
Normes harmonisées :

EMV-Richtlinie 2004/108/EG
EMC directive
Directive CEM

Angewendete harmonisierte Normen: EN 55022:2006
Harmonised standards applied: EN 55024:1998+A1:2001+A2:2003
Normes harmonisées : EN 61000-6-2:2005
 EN 61000-4-2
 EN 61000-4-3
 EN 61000-4-4
 EN 61000-4-5
 EN 61000-4-6
 EN 61000-4-8

Weitere angewendete Normen: CFR 47, FCC Part 15B
Other harmonised standards applied: C-Tick AS/NZS 3548 CISPR 22:2005 (mod.)
Autres normes harmonisées :

Anschrift: MOBOTIX AG
Address: Kaiserstrasse
Adresse : 67722 Langmeil
 Germany

+ TK-Nr. / Phone number / N° de communication :

Fon: +49 6302 9816-0
Fax: +49 6302 9816-190
E-Mail: info@mobotix.com

Langmeil, 23.10.2009

Ort, Datum
Place & date of issue
Lieu et date



Dr. Ralf Hinkel
 Vorstand/CEO, MOBOTIX AG

Name und Unterschrift
Name and signature

Nom et signature

MOBOTIX – The HiRes Video Company



**To demonstrate our confidence in the quality of our products,
MOBOTIX cameras were used to capture all the images that
appear in this manual.**

Manufacturer

MOBOTIX AG
Kaiserstrasse
D-67722 Langmeil
Germany

Tel : +49 6302 9816-103
Fax: +49 6302 9816-190

<http://www.mobotix.com>
sales@mobotix.com

Executive Board

Dr. Ralf Hinkel

Registration Office: Kaiserslautern Local Court
Registration Number: HRB 3724

Tax Code: 44/676/0700/4

Tax Office: Worms-Kirchheimbolanden, Germany

VAT ID:

DE202203501

You can find the latest version of this document
at www.mobotix.com under **Support**.



Technical specifications subject to change without notice!



More Camera For Less. Guaranteed!

The M24M series from MOBOTIX offers extremely compact, cost-effective and exceptionally powerful allround cameras with the widest range of lenses, including panorama version. Fully equipped with IP66-certified housing and long-term internal storage on a MicroSD card.

M24M Allround L22



M24M Allround L11



M24M Allround CS-Vario



Latest PDF file:

www.mobotix.com > Support > Manuals

HiRes
3 Megapixel
2048 x 1536
Software zoom

Skylene
Format free
Each image format
freely definable

30 Frames/s
VGA (640 x 480)
30 F/s Mega

Virtual PTZ
Digital pan, tilt,
zoom

Backlight
Safe using CMOS
without mechanical Iris

Internal DVR
Internal via Flash,
external via Network

Win/Liv/Mac
Recording
via Network on PC
up to 1 Terabyte

Microphone & speaker
Audio
bi-directional via IP,
variable framerates

SIP-Client with video
IP Telephony
Alarm notify,
cam remote control

VideoMotion
Multiple windows
precision pixel-based

-22 to +140 °F
Weatherproof
-30 to +60 °C, IP65,
no heating necessary

IEEE 802.3at
PoE
Network power
even in winter

Robust
No moving parts
fiber glass housing

MoCC/MeEasy
Licence free
Video-Management-
Software

HiRes Video Innovations

The German company MOBOTIX AG is known as the leading pioneer in network camera technology and its decentralized concept has made high-resolution video systems cost efficient.

MOBOTIX AG • D-67722 Langmeil • Tel: +49-6302-9816-103 • Fax: +49-6302-9816-190 • sales@mobotix.com