

Camera Manual

AllroundDual M16



33.068-002_EN_09/2020

THE MOBOTIX INFORMATION CHANNELS

 Beyond Human Vision	<p>Support on the MOBOTIX Website www.mobotix.com/en/support</p>	
	<p>The MOBOTIX Video Tutorials www.mobotix.com/en/support/download-center/documentation/video-tutorials</p>	
	<p>Seminars on MOBOTIX Campus www.mobotix.com/en/support/trainings</p>	
	<p>The MOBOTIX YouTube Channel www.youtube.com/user/MobotixAG</p>	

MOBOTIX Seminars

MOBOTIX offers inexpensive seminars that include workshops and practical exercises. For more information, visit www.mobotix.com > Support > Trainings.

Copyright Information

All rights reserved. MOBOTIX, the MX logo, *MxManagementCenter* and *MxPEG* are trademarks of MOBOTIX AG registered in the European Union, the U.S.A., and other countries. *Microsoft*, *Windows* and *Windows Server* are registered trademarks of Microsoft Corporation. *Apple*, the *Apple logo*, *Macintosh*, *OS X*, *iOS*, *Bonjour*, the *Bonjour logo*, the *Bonjour icon*, *iPod* and *iTunes* are trademarks of Apple Inc. registered in the U.S.A. and other countries. *iPhone*, *iPad*, *iPad mini* and *iPod touch* are Apple Inc. trademarks. *Linux* is a trademark of Linus Torvalds. All other marks and names mentioned herein are trademarks or registered trademarks of the respective owners.

Copyright © 1999-2020, MOBOTIX AG, Langmel, Germany. Technical information subject to change without notice. MOBOTIX AG and its subsidiaries do not assume any liability for technical or editorial errors or omissions contained herein.

Download the latest version of this and other manuals as PDF files from www.mobotix.com > Support > Download Center > Documentation > Manuals.

TABLE OF CONTENTS

Legal Notes	6
Safety Warnings	7
Foreword	8
1 Product Overview	10
1.1 Camera Variants – Lenses, Hardware, Image Formats	10
1.2 Camera Variants – Software Features	11
1.3 Technical Specifications M16/M16-Thermal/M16-Thermal-TR	12
1.4 Delivered Parts and Dimensions	14
1.4.1 M16 Body (Base Module)	14
1.4.2 M16-Thermal/M16-Thermal-TR Model Variants	17
1.4.3 Sensor Modules B016	20
1.4.4 Sensor Modules B036, B041, B061, B079, B119, B237	22
1.4.5 Sensor Modules B500	24
1.4.6 M16 Complete Camera Day/Night	26
1.5 Available Accessories	27
1.5.1 Polarization Filter	27
1.5.2 MiniUSB Cable to MiniUSB (Angled/Straight)	27
1.5.3 MiniUSB Cable to MiniUSB (Angled/Angled)	27
1.5.4 MiniUSB Cable to USB-A Socket	27
1.5.5 Ethernet Patch Cable for Bayonet Catch	28
1.5.6 NPA-PoE-Set	28
1.5.7 MX-Overvoltage-Protection-Box	28
1.5.8 MX-NPA-Box	29
1.5.9 MX-GPS-Box	29
1.5.10 MX-232-IO-Box	29
1.5.11 ExtIO Expansion Module	30
1.5.12 Mx2wire+ Media Converter	30
1.5.13 Security Screw Set with Allen Bit	30
1.5.14 Sealing Ring as Dome Replacement for Sensor Modules B016	30
1.5.15 Other Accessories	31
1.6 MOBOTIX Software	32
1.6.1 Integrated Camera Software (Firmware)	32
1.6.2 MxManagementCenter	33
1.6.3 MOBOTIX MxBell	34

2	Installation	36
2.1	Preparing the Installation	36
2.1.1	Installation Options: Wall, Ceiling, Pole	36
2.1.2	Installing the Camera with Hemispheric Sensor Modules	39
2.1.3	Network Connection and Power Supply, UPS	42
2.1.4	Providing the Camera Connections, MX-Overvoltage-Protection-Box	43
2.1.5	Wiring, Fire Prevention, Lightning and Surge Protection	44
2.2	First Installation Steps	45
2.2.1	Initial Installation of the Sensor Modules (Except M16 Complete Cameras)	45
2.2.2	Opening the Camera Housing	47
2.2.3	Installing the Security Clips (Optional, Not Required for M16 Complete Cameras)	48
2.2.4	Exchanging Sensor Modules	49
2.2.5	Replacing the Ethernet Patch Cable	50
2.2.6	Connecting a USB Cable	52
2.2.7	Connecting a Two-Wire MxBus* Cable	53
2.2.8	Closing the Camera Housing	54
2.3	Mounting the Camera with Wall Mount	56
2.3.1	VarioFlex Wall Mount	56
2.4	Mounting the Camera with Ceiling Mount*	60
2.4.1	VarioFlex Ceiling Mount	60
2.5	Mounting the Camera with Pole Mount (Accessories)	64
2.5.1	Pole Mount (MX-MH-SecureFlex-ESWS)	65
2.6	Replacing the MicroSD Card	69
2.7	Network and Power Connection	71
2.7.1	Network Cabling for M16 with Patch Cables	71
2.7.2	Power Supply Using a Switch	72
2.7.3	Power Supply When Connected Directly to a Computer	73
2.7.4	Power Supply with Power-Over-Ethernet Products	73
2.7.5	Variable PoE	74

Table of Contents

3	Operating The Camera	76
3.1	Manual and Automatic Operation – Overview	76
3.2	First Images and the Most Important Settings	78
3.2.1	Manually Setting Up the Network Parameters in a Browser	78
3.2.2	First Images and the Most Important Settings in the Browser	81
3.2.3	First Images and Network Parameter Configuration in MxMC	83
3.2.4	Start Options of the Camera	86
3.3	Adjusting Camera, Lens Focus and Installing Filters	88
3.3.1	Adjusting the Camera	88
3.3.2	Adjusting Lens Focus (B119/B237 Only)	89
3.3.3	Inserting a Filter	90
3.3.4	Replacing the Dome Against the Sealing Ring (B016 Only)	91
3.4	Virtual PTZ and Full Image Recording	93
3.4.1	Preparing the Virtual PTZ Function	93
3.4.2	Full Image Recording	95
3.4.3	Special M16 Configuration in the Browser	97
3.5	MicroSD Card Recording	106
3.5.1	Introduction	106
3.5.2	Formatting the MicroSD Card	108
3.5.3	Activating Recording	109
3.5.4	Accessing Data on the MicroSD Card	110
3.5.5	Deactivating Card Recording	110
3.5.6	Using a MicroSD Card in a Different MOBOTIX Camera	111
3.5.7	Limitations on Warranty When Using Flash Storage Media	111
3.6	Configuration in the Browser	112
3.6.1	Overview	112
3.6.2	General Browser Settings	114
3.6.3	Configuring the M16-Thermal(-TR) in the Browser	115
3.7	Additional Notes	117
3.7.1	Operation with Only One Sensor Module	117
3.7.2	Password for the Admin Menu	117
3.7.3	Permanently Deactivating the Microphone	117
3.7.4	Using the Start Options of the Camera	118
3.7.5	Activating Event Control and Motion Detection	118
3.7.6	Deactivating Text and Logo Options	118
3.7.7	Deactivating the Camera Reboot	118
3.7.8	Browser	119
3.7.9	Cleaning the Camera and Lens	119
3.7.10	Online Help and Camera Information in the Browser	119
3.7.11	Declaration of Conformity	119
3.7.12	RoHS Declaration	120
3.7.13	Disposal	120
3.7.14	Disclaimer	120

LEGAL NOTES



Attention – Special Export Laws Apply!

Cameras with thermal image sensors (“thermal cameras”) are subject to the special export regulations of the U.S.A. and the ITAR (International Traffic in Arms Regulation):

- Under the United States sanctions and export regulations currently in force, cameras with thermal screen sensors or parts thereof may not be delivered, in particular, to countries or regions to which the U.S.A. have imposed an embargo, unless a special exemption permit is available. At present, this applies to the following countries or regions: Syria, Iran, Cuba, North Korea, Sudan and Krim. The same export ban applies to all persons and institutions listed in “The Denied Persons List” (see www.bis.doc.gov > **Policy Guidance > Lists of Parties of Concern**; <https://www.treasury.gov/resource-center/sanctions/sdn-list/pages/default.aspx>).
- Under no circumstances must the camera itself or its thermal image sensors be used in the design, the development or in the production of nuclear, biological or chemical weapons or in the weapons themselves.

Legal aspects of video and sound recording

You must comply with all data protection regulations for video and sound monitoring when using MOBOTIX products. Depending on national laws and the installation location of the M16, the recording of video and sound data may be subject to special documentation or it may be prohibited. All users of MOBOTIX products are therefore required to familiarize themselves with all applicable regulations and to comply with these laws. MOBOTIX AG is not liable for any illegal use of its products.

SAFETY WARNINGS

Notes on Installing:

- This product must not be used in locations exposed to the dangers of explosion.
- Make sure that you install this product as outlined in Chapter 2, «Installation» of this manual. A faulty installation can damage the camera!
- When installing this product, make sure that you are only using genuine MOBOTIX parts and MOBOTIX connection cables.
- Only install this product on suitable, solid materials that provide for a sturdy installation of the fixing elements used.



Electrical installation: Electrical systems and equipment may only be installed, modified and maintained by a qualified electrician or under the direction and supervision of a qualified electrician in accordance with the applicable electrical guidelines. Make sure to properly set up all electrical connections.



Electrical surges: MOBOTIX cameras are protected against the effects of small electrical surges by numerous measures. These measures, however, cannot prevent the camera from being damaged when stronger electrical surges occur. Special care should be taken when installing the camera outside of buildings to ensure proper protection against **lightning**, since this also protects the building and the whole network infrastructure.



Max. power consumption of attached extension modules: The power consumption of all attached **MxBus modules** must **not exceed 3 W**. When attaching modules to the MxBus connector **and** the USB socket, the **power consumption of all attached modules must not exceed 4 W, if the camera is powered by PoE class 3**. If **PoE class 2** is used, **the camera cannot power any peripheral devices!**



Never touch the lenses: Due to the high performance of the M16, the area of the image sensor **can get quite hot**, especially when the ambient temperature is also high. This does not affect the proper functioning of the camera in any way. For this reason, the product must not be installed within the reach of persons without domes or protective lens covers.



Power off before opening the camera: Make sure the power supply to the camera is disconnected before opening the camera housing (e.g., when inserting or exchanging lenses, lens units and SD cards).



Network security: MOBOTIX products include all of the necessary configuration options for operation in Ethernet networks in compliance with data protection laws. The operator is responsible for the data protection concept across the entire system. The basic settings required to prevent misuse can be configured in the software and are password-protected. This prevents unauthorized parties from accessing these settings.





FOREWORD

Dear MOBOTIX customer,

Congratulations on your decision to purchase the M16, the powerful successor to the original MOBOTIX M1/M10/M12/M15, proven over one hundred thousand times. This weatherproof (IP66), versatile, all-round solution “Made in Germany” represents an important milestone in the successful history of MOBOTIX products.

As decentralized complete video systems, MOBOTIX cameras have much more to offer than conventional network cameras. The M16 features integrated environment sensors (PIR, outside temperature, motion sensor), speaker and microphone for two-way video communication based on the SIP standard, long-term memory, free video management software and a preassembled VarioFlex wall/ceiling mount, in addition to two HiRes image sensors. The weatherproof MxBus and MiniUSB interfaces allow for direct connection of MOBOTIX interface boxes and standard devices such as UMTS modules, additional memory, etc.

With the M16, one or two separate and interchangeable MOBOTIX sensor modules (lens plus sensor board and microphone) are installed in the camera base module M16 Body. The **sensor modules** can be purchased from tele lens to Hemispheric, each available as day or night models. In addition, the LPF (“Long Pass Filter”) variants of the night models have been designed for special requirements (such as number plate recognition). If the M16 is configured with a Day and a Night sensor module, the camera will automatically switch to the appropriate image sensor depending on the illumination.

The introduction of the newest sensor technology with increased light sensitivity in combination with the new HD Premium lenses (aperture f/1.8) not only generates more brilliant images with up to 3072x2048, it also delivers color images of higher quality under lowlight conditions.

The new model variant **M16-Thermal** supplements the proven MOBOTIX technology by a high-end thermal imaging sensor, which can reliably detect moving objects even in total darkness. The **M16-Thermal-TR** (*TR = Thermal Radiometry*) can trigger alarms when detecting temperatures in the image or in measurement windows that exceed or drop below the specified temperature.

The **MxManagementCenter** video management software, which is tailored to MOBOTIX cameras, and a PDF manual can be downloaded from the MOBOTIX website at no cost: www.mobotix.com > Support > Download Center > Software Downloads. The tutorial for the application is available under Support > Download Center > Documentation > Brochures & Guides > Tutorials. MOBOTIX also provides a mobile solution for the iPad, iPhone and iPod Touch iOS devices. Search for “MOBOTIX AG” in the App Store or on Google Play to find the free MOBOTIX MxBell app.

If you still have any questions, our support and international sales staff are available at intl-support@mobotix.com from Monday through Friday.

Thank you for choosing MOBOTIX products and services. We wish you all the best with your new, high-performance MOBOTIX M16 AllroundDual camera!



MOBOTIX

BeyondHumanVision
BeyondHumanVision

MOBOTIX

1 PRODUCT OVERVIEW

1.1 Camera Variants – Lenses, Hardware, Image Formats

Camera Model		
	M16	M16-Thermal(-TR)
Lenses with 6MP Image Sensors		
B016 Hemispheric (right/left)	•/•	-/•
B036 Super Wide-Angle (right/left)	•/•	-/•
B041 Super Wide-Angle (right/left)	•/•	-/•
B061 Wide-Angle (right/left)	•/•	-/•
B079 Standard (right/left)	•/•	-/•
B119 Tele (right/left)	•/•	-/•
B237 Tele (right/left)	•/•	-/•
B500 Tele (right/left)	•/•	-/•
CSVario 4.5 to 10 mm (right/left)	•/•	-/•
Image sensor with individual exposure zones	Color/BW/LPF (any combination)	Thermal image sensor (+ optional color/BW/LPF)
Image sensor sensitivity 6MP in Lux at 1/60 s / 1 s	0.1 / 0.005 or 0.02 / 0.001	NETD typ. 50 mK, <79 mK (color/BW/LPF see left)
Hardware Features		
IP protection class	IP66	IP66
Temp. internal DVR (MB)	64	64
Internal DVR (SDXC, SDHC pre-installed)	•	•
Microphone/Speaker	•/•	•/•
Passive infrared sensor (PIR)	•	•
Internal/ambient temperature sensor	•/•	•/•
Shock Detector	•	•
Power consumption with 1/2 sensor mod.	typ. 7 W/7.5 W	typ. 7.5 W/8 W
Variable PoE class	2 – 3	3
Image Formats, Frame Rates and Image Storage		
Max. image size (per sensor)	6MP (3072x2048)	6MP (3072x2048)
Max. frame rate (MxPEG, max. image size)	6MP: 12 fps	6MP: 12 fps Thermal: 9 fps
CIF images with 4 GB MicroSD DVR	250,000	250,000
VGA images with 4 GB MicroSD DVR	125,000	125,000
MEGA images with 4 GB MicroSD DVR	40,000	40,000
QXGA images with 4 GB MicroSD DVR	20,000	20,000

1.2 Camera Variants – Software Features

Camera Model	
	M16/M16-Thermal(-TR)
General Features	
Digital zoom (continuous) with panning	•
Motion JPEG/MxPEG codecs	-/•
Custom exposure windows	• (not for thermal sensor)
Temperature measurement alarms	(M16-Thermal-TR only)
Snapshot rec. (pre-/post-alarm images)	50
Terabyte ring buffer (internal/network)	•
Continuous/event rec. with sound (0.2 to 30 fps)	•
Time and event control	•
Weekly schedules/holidays	•
Web functionality (FTP, email)	•
Playback/Quad and MultiView	•
Bidirectional audio in browser	•
Logo generator, animated	•
Flexible event logic	•
Master/slave arming	•
Several scheduled privacy zones	•
Customized voice messages	•
VoIP telephony (audio/video, alarm)	•
Remote alarm notification	•
Signal inputs/outputs, RS232	Via MX-Input-Box/MX-Output-Box or MX-232-IO-Box
Programming interface/HTTP API	•
Security features (HTTPS/SSL, IP-level access control, network authentication IEEE 802.1X)	•
Video Analysis	
Video Motion detection	•
MxAnalytics	–
MxActivitySensor	•
Video Management Software	
MxManagementCenter	•
MOBOTIX MxBell	•

Free-of-charge download from www.mobotix.com or App Store/Google Play

1.3 Technical Specifications M16/M16-Thermal/M16-Thermal-TR



M16 with two MX sensor modules
(Day/Night/LPF)



M16 with one MX sensor module
(Day/Night/LPF)



M16-Thermal(-TR) with one add. MX sensor module
(Day/Night/LPF, optional)

Model Versions	Mx-M16A/B* (any comb. of Day/Night/LPF sensor modules) Mx-M16TA/B(-TR)* (optionally one add. Day/Night/LPF sensor module) *Variant Mx-M16B supports MOBOTIX MxBus modules
Lens Options Mx Sensor Module	10 to 270 mm (35 mm format), hor. angles of view 180° to 8° (6MP)
Lens Options Thermal Image Sensor	43, 65, 135 mm (in 35 mm format), 45°, 25°, 17° horizontal angle of view
Sensitivity Mx Sensor Module	Color sensor (6MP): 0.1 Lux at 1/60 s, 0.005 Lux at 1 s Black&White sensor (6MP): 0.02 Lux at 1/60 s, 0.001 Lux at 1/1 s
Sensitivity Thermal Image Sensor	NETD typ. 50 mK, IR range 7.5 to 13.5 μm Range of temperature measuring: -40 to 550 °C/-40 to +1,022 °F Precision Sensor Module Thermal-TR: ±10 K of the thermal radiation received at the sensor
Image Sensor Mx Sensor Module	1/1.8" CMOS, 6MP, progressive scan
Image Sensor Thermal Image Sensor	Uncooled microbolometer, 336x252 pixels
Max. Image Size Mx Sensor Module	Color: 3072x2048 (6MP), 6144x2048 (12MP) Black&White: 3072x2048 (6MP), 6144x2048 (12MP)
Max. Image Size Thermal Image Sensor	Can be scaled up to 3072x2048 (6MP), automatically scaled to size of Mx sensor module
Image Formats (Independent of Type, Per-Sensor Setting)	3072x2048 (6MP), 2592x1944 (5MP), 2048x1536 (QXGA), 1920x1080 (Full-HD), 1280x960 (MEGA), 1280x720 (HD), 1024x768, 800x600, 768x576 (D1-PAL), 704x576 (TV-PAL), 640x480, 384x288, 320x240, 160x120, custom formats
Max. Frame Rate Mx sensor module	MxPEG* (max): 42@HD (1280x720), 34@Full-HD, 24@QXGA, 15@5MP, 12@6MP, 6@2x6MP M-JPEG* (max): 26@HD (1280x720), 13@Full-HD, 9@QXGA, 5@5MP, 4@6MP, 2@2x6MP H.264 (max): 25@Full-HD, 20@QXGA *Single core use only
Max. Frame Rate Thermal Image Sensor	9 fps (when displaying an Mx sensor module and a thermal sensor module, the overall frame rate of the camera is reduced to 9 fps)
Video Codec	MxPEG, M-JPEG, JPEG (max. output size 6MP) H.264 (max. output size QXGA, bandwidth limitation applicable)
ONVIF	ONVIF-S (camera software V5.2.x and higher, 2nd half of 2018)
Internal DVR	MicroSD card (SDXC, SDHC pre-installed)
External Video Ring Buffer	Directly on NAS or PC/Server, no additional recording software required
Software (Included)	MxManagementCenter video management software
Image Processing	Backlight compensation, automatic white balance, image distortion correction, panorama correction, video sensors (video motion detection/MxActivitySensor), optional off-color/black & white display of thermal image sensor
Virtual PTZ	Digital pan/tilt/zoom, continuous up to 8X

Camera Variants – Lenses, Hardware, Image Formats

Alarm/Events	Video Motion detection, MxActivitySensor, external signals, temperature sensor, PIR, microphone, shock detector (with firmware version 5.0.1 and higher), notification via e-mail, FTP, IP telephony (VoIP, SIP), visual/sound alarms, pre- and post-alarm images
Microphone and Speaker	Integrated microphone and speaker
Audio Functions	Lip-synchronous audio, two-way communication, audio recording
Interfaces	Ethernet 100Base-T, MiniUSB, MxBus*; inputs/outputs and RS232 via accessories *Only variant Mx-M16B
Video Telephony	VoIP/SIP, two-way communication, remote controlling using key codes, event notification
Security	User/group management, HTTPS/SSL, IP address filter, IEEE 802.1x, intrusion detection, digital image signature
Certifications	EN55032:2012, EN55022:2010; EN55024:2010; EN50121-4:2015, EN61000-6-1:2007; EN 61000-6-2:2005, EN61000-6-3:2007+A1:2011, EN61000-6-4:2007+A1:2011, AS/ NZS CISPR22:2009+A1:2010, CFR47 FCC part15B
Power Supply	Year-round Power-over-Ethernet (IEEE 802.3af); PoE class variable (Class 3 required for M16-Thermal(-TR) and when connecting MxBus/USB modules)
Power Consumption	M16: Typ. 7W with one sensor module, 7.5 W with two sensor modules M16-Thermal/M16-Thermal-TR Typ. 7.5 W with thermal image sensor, 8 W with 1 additional sensor module
Power Consumption of External Devices	At MxBus: max. 3W, at USB: max. 2.5 W, total max. 4 W. The power consumption of the camera will increase accordingly!
Operating Conditions	IP66, -40 to 60 °C/-40 to 140 °F (cold start min. temp. -30 °C/-22 °F), air humidity up to 90–100% (according to EN 50155 Chap. 12.2.5)
Protection Against Mechanical Impact	(According to IEC 62262/EN 50102) M16 with hemispheric sensor modules: IK07 M16 with other sensor modules: IK06
Dimensions M16, M16-Thermal(-TR)	W x H x D with wall mount: 158 x 244 x 239 mm; W x H x D with ceiling mount*: 158 x 210 x 207 mm
Weights M16 without Sensor Modules	Weight with wall mount: approx. 1,160 g Weight with ceiling mount*: approx. 1,110 g
Weights M16-Thermal(-TR) without Add. Sensor Module	Weight with wall mount: approx. 1,320 g Weight with ceiling mount*: approx. 1,270 g
Dimensions/Weights Sensor Modules	SMA-S-6D/N/L016: Ø x D: 43 x 45 mm (installation dim.), weight 85 g SMA-S-6D/N/L041/079: Ø x D: 43 x 57 mm (installation dim.), weight 111 g SMA-S-6D/N/L061/119/237: Ø x D: 43 x 60 mm (installation dim.), weight 122 g SMA-S-6D/N/L500: Ø x D: 43 x 60 mm (installation dim.), weight 160 g
Standard Delivery	Housing (high-resistance composite, PBT), white, shock-resistant dome for SMA-S-6D/N/L016 sensor module, coated glass pane for all other Mx sensor modules, protective Germanium cover for thermal image sensor (only M16-Thermal/M16-Thermal-TR), accessories for installation on wall and ceiling, conversion set for ceiling mount*, Allen wrench, 50 cm patch cable, software, MicroSD card (pre-installed) *Only included if this had been specified when ordering the camera!

1.4 Delivered Parts and Dimensions

Visit www.mobotix.com and go to **Product Selector > Outdoor Cameras > M16**

1.4.1 M16 Body (Base Module)



Standard Delivery

Item	Count	Part Name
1.1	1	Camera housing with mainboard and wall mount (installed), without sensor modules and front element
1.2	1	Front element with additional sensors (installed)
1.3	2	Transport plugs (installed)
1.4	1	Dummy module (must be installed when using only one sensor module)
1.5	4	Inner housing cover (installed)
1.6	4	Stainless steel Allen screw with flat head M4x8 for inner housing cover (installed)
1.7	2	Cable lock black with bayonet catch (Ethernet patch cable, USB, one mounted, one supplied)
1.8	2	Single wire plug, blue (MxBus*, USB, mounted)
1.9	1	MicroSD card (SDXC, SDHC pre-installed)
1.10	1	Ethernet patch cable, 50 cm/19.7 in with sealing (installed)
1.11	2	Sensor module cable 15 cm/6 in (installed in camera)
1.12	1	I/O cable with red clips to front element 15 cm/6 in (installed)
1.13	1	Hinged ferrite for Ethernet cable (installed)

*Only supported by Mx-M16B variant

Delivered Parts and Dimensions

Standard Delivery		
Item	Count	Part Name
1.14	1	Hinged ferrite for sensor module cable (installed)
1.15	2	Rubber plug for covering mounting screws, white
1.16	3	Stainless steel Allen screw M6x30 (installed)
1.17	3	Stainless steel washer Ø 6.4 mm (installed)
1.18	1	Stainless steel spring washer Ø 6.4 mm (wall/ceiling mt., inst.)
1.19	1	Stainless steel lock nut M6 (wall/ceiling mount, installed)
1.20	1	Rubber plug, black (installed)
Mounting Supplies		
M.1	4	Stainless steel washer Ø 6.4 mm
M.2	4	Dowels 8 mm
M.3	4	Stainless steel wood screw with hex head 6x50 mm
M.4	1	Allen wrench 2.5 mm
M.5	1	Allen wrench 5 mm
M.6	1	Lens wrench (B016 lens, glass/filter insert, dome)
M.7	1	Module key (sensor module, focusing of lenses)
M.8	1	Rubber sealing for wall/ceiling mount, white
M.9	1	Ceiling mount for VarioFlex mount (only included if this had been specified when ordering the camera!)
M.10	4	Protection cover for screw, white
M.11	4	Security clip for sensor or blind modules, red

Design of the MOBOTIX M16

The Base module of the MOBOTIX M16 consists of the camera housing with VarioFlex mount (wall or ceiling) and the front element.

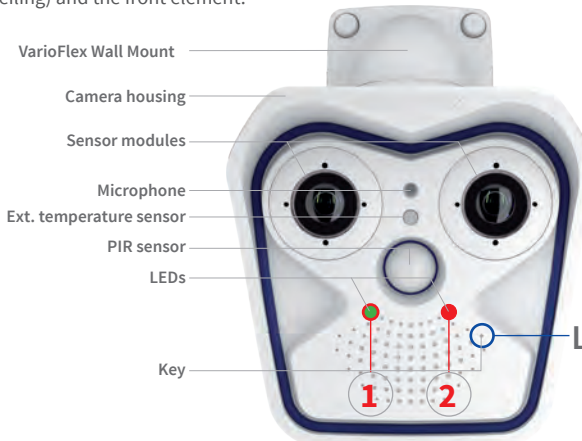

LED default settings

- 1 Power (an), Error (flashes)
- 2 Recording (flashes)

To press the key, use a **paper clip** for example, but **never use sharp or pointed objects!**

Connections of the MOBOTIX M16

The MOBOTIX M16 has the following connections that are accessible once the housing has been opened (see Section 2.2.2, «Opening the Camera Housing»):



Only use cables with **angled plugs** inside the housing of the M16 (exceptions: patch cables, MxBus connection wires)!

Only use the corresponding MOBOTIX cables with sealing ring when using the connections of the M16 shown above:

- Ethernet patch cable: MX-OPT-CBL-LAN-1/2/5/10
- MiniUSB (straight/angled): MX-CBL-MU-EN-STR-05/2/5
- MiniUSB to USB-A (angled to USB socket): MX-CBL-MU-EN-AB-05/2/5

1.4.2 M16-Thermal/M16-Thermal-TR Model Variants

The delivered parts of the **M16-Thermal/M16-Thermal-TR** are slightly different from those of the **M16 Body** (see Section 1.4.1, «M16 Body (Base Module)»):



Changes in the Delivery of the M16-Thermal/M16-Thermal-TR

Item	Count	Part Name
1.2	1	Front element with one thermal/thermal-TR image sensor (right) and additional sensors (installed)
Mounting Supplies		
M.11	2	Security clip for sensor or blind modules, red

The drilling templates are available on www.mobotix.com > Download Center > Documentation > Manuals

Always print or copy drilling templates in original size

Dimensions of the M16 with Wall Mount



Delivered Parts and Dimensions

Dimensions of the M16 with Ceiling Mount*



The drilling templates are available on www.mobotix.com > Download Center > Documentation > Manuals

Always print or copy drilling templates in original size

*Only included if this had been specified when ordering the camera!

1.4.3 Sensor Modules B016

Sensor module including status LEDs and microphone



Item	Number	Part Name
2.1	1	Sensor module with affixed washer
2.2	1	MOBOTIX lens B016 (installed)
2.3	1	Dome (installed)
2.4	1	Cable retainer with bayonet catch (installed)
2.5	1	Sealing plug, blue, small (installed)
2.6	1	Nut (plastic)

Delivered Parts and Dimensions

Front View

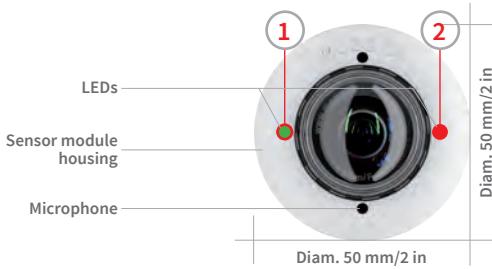

LED default settings:

- 1** Power (on), Error (flashes)
- 2** Recording (flashes)

Rear View

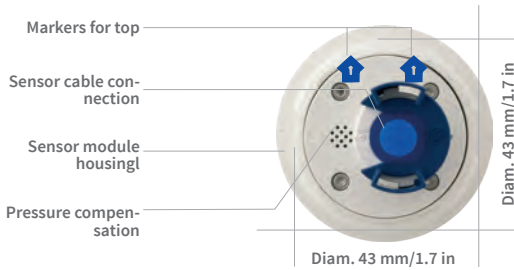

Top = top border of image (North)

Side View

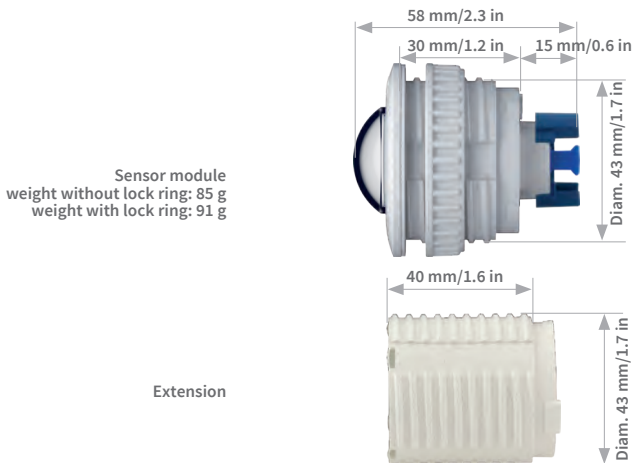

1.4.4 Sensor Modules B036, B041, B061, B079, B119, B237

Sensor module including status LEDs and microphone



Item	Number	Part Name
3.1	1	Sensor module with affixed washer
3.2	1	MOBOTIX lens B036/B041/B061/B079/B119/B237 (installed)
3.3	1	Protective glass insert with coated glass (installed)
3.4	1	Cable retainer with bayonet catch (installed)
3.5	1	Sealing plug, blue, small (installed)
3.6	1	Nut (plastic)

Delivered Parts and Dimensions

Front View

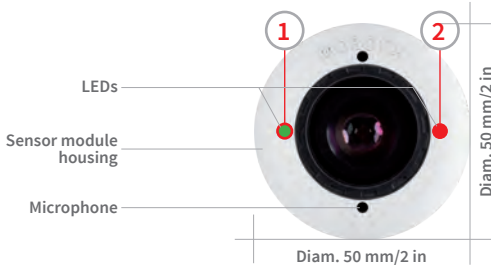

LED default settings:

- 1 Power (on), Error (flashes)
- 2 Recording (flashes)

Rear View

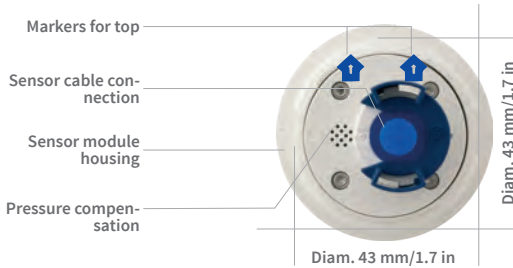

Top = top border of image (North)

Side View

Sensor module weight without lock ring: 122 g
weight with lock ring: 128 g

Extension

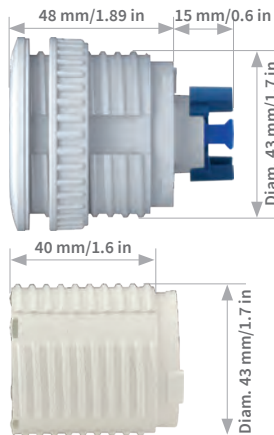

1.4.5 Sensor Modules B500

Sensor module



Item	Number	Part Name
4.1	1	Sensor module with affixed washer
4.2	1	MOBOTIX lens B500 (installed)
4.3	1	Protective lens cover (installed)
4.4	1	Cable retainer with bayonet catch (installed)
4.5	1	Sealing plug, blue, small (installed)
4.6	1	Nut (plastic)

Delivered Parts and Dimensions

Front View

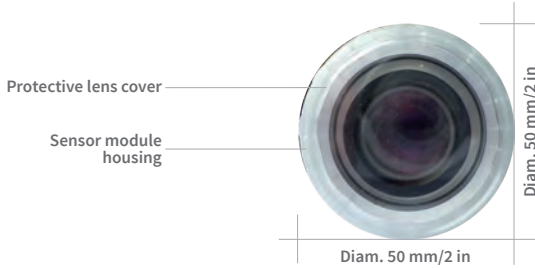

Rear View

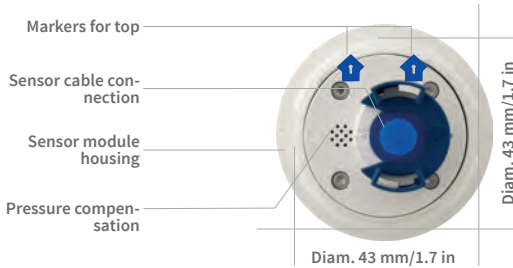

Top = top border of image (North)

Side View

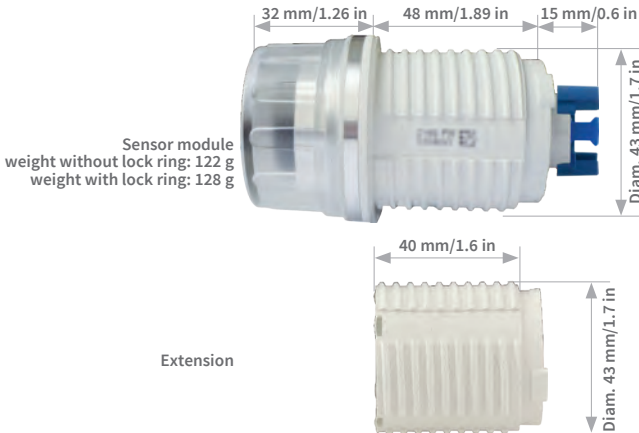

1.4.6 M16 Complete Camera Day/Night

In order to facilitate the installation, you also order the M16 as complete camera with one day and one night lens of the same focal lengths.

Available Combinations of Image Sensors

6MP Sensor Modules
D036 – N036
D041 – N041
D061 – N061
D079 – N079
D119 – N119
D237 – N237

Example: M16 Complete Camera With 32 mm Focal Length



Day lens with 32 mm focal length (color)



Night lens with 32 mm focal length (Black&White)

Mx-M16A/B-6D6N061 (6MP)

Advantages of M16 Complete Cameras

- Weatherproof day/night camera for 24/7 operation with two 6MP image sensors.
- Mechanical theft protection of the sensor modules inside the housing, pre-installed at the factory.
- Simplified ordering of an entire M16 with only one order number.
- Environment-friendly, since less packaging is used for shipping the camera.
- Maintains the full flexibility of the M16 platform system, since the camera's sensor modules are easily exchanged against other modules (on-site by the user, for example).

1.5 Available Accessories

1.5.1 Polarization Filter

Order no: MX-SM-OPT-POL

The polarization filter can suppress annoying reflections and thus enhances recognizability of persons behind windshields, for example. This filter replaces the protective glass insert into the corresponding sensor module (note that this filter *cannot* be used in B016 sensor modules). Use the blue lens wrench (M.6) to rotate the polarization filter and to adjust its orientation (see Section 3.3.3, «Inserting a Filter»). Due to its nature, this filter reduces the amount of light that enters the lens by approximately 50 %. The red sealing ring distinguishes this filter from other filters and the protective lens insert.



1.5.2 MiniUSB Cable to MiniUSB (Angled/Straight)

Order no.: MX-CBL-MU-EN-STR-05/2/5
(angled/straight)

The MOBOTIX MX-232-IO-Box can be connected directly to the M16 with this cable, which is up to five meters long.



Only cables with angled plugs can be used for the M16

1.5.3 MiniUSB Cable to MiniUSB (Angled/Angled)

Order no.: MX-CBL-MU-EN-EN-PG-05/2/5
(angled/angled)

The MOBOTIX ExtIO can be connected directly to the M16 with this cable, which is up to five meters long.



1.5.4 MiniUSB Cable to USB-A Socket

Order no.: MX-CBL-MU-EN-AB-05/2/5

USB-based storage media (for example, USB hard drives) can be connected directly to the M16 with this cable, which is up to five meters long.



1.5.5 Ethernet Patch Cable for Bayonet Catch

Order no.: MX-OPT-CBL-LAN-1/2/5/10
(length: 1 m/2 m/5 m/10 m)

The MOBOTIX-developed special cable can be installed in a waterproof manner and has an integrated sealing gasket. Every M16 ships with a 0.5-m-long cable as standard, which can be exchanged for a patch cable up to 10 m in length.



1.5.6 NPA-PoE-Set

Order no.: MX-NPA-PoE-EU-Set and MX-NPA-PoE-INT-Set (Version EU and Version INT)
Order no.: MX-CBL-NPA-BAT-2 (battery cable for mobile voltage sources)

This is a multi-functional PoE injector according to the IEEE 802.3af standard – with three connectors (for network, camera/PoE device, PC), universal power supply unit with interchangeable adapter plugs and crossover function. The NPA-PoE-Set connects and remotely supplies a M16 with power via an Ethernet cable up to 100 m/328 ft in length. The blue adapter can also be connected to mobile voltage sources from 12 to 57 V DC by means of an additionally available battery cable. The “EU” version of the NPA-PoE-Set is supplied as standard with a European adapter, while the “INT” version includes four adapters (EU, USA, UK, AUS).



1.5.7 MX-Overvoltage-Protection-Box

Order no.: MX-Overvoltage-Protection-Box-RJ45
Order no.: MX-Overvoltage-Protection-Box-LSA

Weatherproof network connector (protection class IP65, -30 to 60 °C/-22 to 140 °F) **with surge protection of up to 4 kV for MOBOTIX IP cameras**, ideal for replacing the MX-Patch-Box.

At the same time, the MX-Overvoltage-Protection-Box provides a weatherproof connection of a camera's patch cable to a network patch cable (-**RJ45** variant) or a network installation cable (-**LSA** variant).



1.5.8 MX-NPA-Box

Order no.: MX-OPT-NPA1-EXT

The MX-NPA-Box is a weatherproof PoE injector conforming to the IEEE 802.3af standard and is designed to connect to a MOBOTIX camera external voltage sources (12 to 57 V DC).

The MX-NPA-Box is equipped with the Patch-Box's weatherproof and extremely compact exterior housing (protection class IP65, -30 to 60 °C/-22 to 140 °F), which means it can also be installed in the space of the Outdoor Wall Mount. Interfaces of the MX-NPA-Box: Camera via patch cable, Ethernet via LSA+ and external power supply via terminal connector (12 to 57 V DC possible).



1.5.9 MX-GPS-Box

Order no.: MX-OPT-GPS1-EXT

This box primarily serves as a high-precision time source for systems without an Internet connection. In addition, the cameras can trigger GPS-based events (reaching or moving away from a specified position; exceeding or not reaching a specified speed). The MX-GPS-Box can be connected as an add-on module to all MOBOTIX cameras with an MxBus interface.

The MX-GPS-Box is equipped with the same compact housing as the other interface boxes (protection class IP65, -30 to 60 °C/-22 to 140 °F). This interface box should not be installed inside of other wall mounts, but on the exterior of the building with a large section of open sky above it. This ensures the best possible reception from GPS satellites and thereby the highest possible accuracy of the received GPS data. The maximum length of the MxBus wiring (0.8 mm diameter wires) is 50 m/55 yd.



1.5.10 MX-232-IO-Box

Order no.: MX-OPT-RS1-EXT

This box provides the signal inputs and outputs as well as the RS232 (serial) interface. It replaces the connections that were handled on the older camera models via a D-Sub 15-HD connector. The MX-232-IO-Box (protection class IP65, -30 to 60 °C/-22 to 140 °F) can be attached to all MOBOTIX cameras with an MxBus or USB interface. The maximum length of the MxBus wiring (0.8 mm diameter wires) is 50 m/55 yd. If the MiniUSB connector is used, the maximum cable length is 5 m/16 ft.



1.5.11 ExtIO Expansion Module

Order no.: MX-ExtIO

The device, which is suitable both for on-wall and cavity-wall installations, contains a powerful speaker, microphone, infrared motion sensor, ambient temperature sensor, two input and two output contacts and two illuminated keys. It is ideal for door communication, elevators, access control systems, etc. The ExtIO is suitable for use as direct connection to the M16 via a MiniUSB cable (max. 5 m), which can be ordered separately, or as a network connection via the PoE switch.



1.5.12 Mx2wire+ Media Converter

Order no.: MX-2WirePlus-Set-PW

The Mx2wire+ system allows an Ethernet network with PoE to be set up via two-wire cables, which saves users from having to lay several hundred meters of Ethernet cable. For example, an existing two-wire cable of an analog video camera can be reused to connect a high-resolution and modern IP network camera. Mx2wire+ is delivered in the standard wall outlet frame in different designs; however, it can also be used with the available on-wall socket that is included.



1.5.13 Security Screw Set with Allen Bit

Order no.: MX-OPT-SEC-SCREWS-SET

Use this triple set of security screws for plugs (4 pcs 6x50) and for machine threads (4 pcs M6x15, 4 pcs M6x30) to securely attach the VarioFlex foot of the wall mount. The Allen bit supplied with the set (1/4 in drive with hole for security pin) fits regular power screwdrivers.

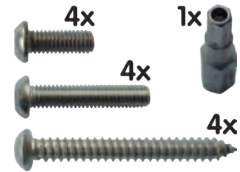

1.5.14 Sealing Ring as Dome Replacement for Sensor Modules B016

Order no.: MX-OPT-Ring-L10-L12-PW/BL

For special scenarios with hemispheric sensor modules, e.g., if light entering from the side creates reflections within the dome, you can use the sealing ring instead of the dome (see also Section 3.3.4, «Replacing the Dome Against the Sealing Ring (B016 Only)»). **In order to avoid burns by the hot lens, the dome must not be removed if the sensor module is within the reach of persons!**



1.5.15 Other Accessories

Since the range of accessories for the MOBOTIX system keeps growing, you will find the list of applicable accessories in the **Camera Configurator** on the MOBOTIX website www.mobotix.com.

THE MOBOTIX INFORMATION CHANNELS

MOBOTIX
BeyondHumanVision

Support on the MOBOTIX Website
www.mobotix.com/en/support



The MOBOTIX Video Tutorials
www.mobotix.com/en/support/download-center/documentation/video-tutorials



Seminars on MOBOTIX Campus
www.mobotix.com/en/support/trainings



The MOBOTIX YouTube Channel
www.youtube.com/user/MobotixAG



1.6 MOBOTIX Software

1.6.1 Integrated Camera Software (Firmware)

MOBOTIX cameras and connected MxBus modules operate with built-in firmware whose functions are accessed by the MOBOTIX MxManagementCenter remote stations and MOBOTIX MxBell.

The M16 models therefore also feature a variety of functions that are integrated in the firmware: from motion detection and long-term storage right through to alarm notification via video IP telephony. The virtual PTZ functions allow you to continuously zoom into or out of a MOBOTIX camera image using either the mouse wheel or a joystick.

When recording image or video sequences, you can choose to store either the section of the live image that is visible or the full sensor image (full image storage). This also allows you to examine parts of an image or video that had not been visible in the live image section on display at the time of the recording.

Unlike in the camera systems from other manufacturers, there is no need to buy and install additional software on your computer thanks to the MOBOTIX firmware that can be accessed directly in a web browser via the camera IP address. Instead of using a web browser, you can also download the free MxManagementCenter video management software from the MOBOTIX website (www.mobotix.com > Support > Download Center > Software-Downloads) to quickly display multiple cameras on one monitor or on an entire video wall, switch alarms with sound or conveniently search for an event. The MOBOTIX MxBell for iOS and Android devices (iOS 11/Android 5.0 and higher) is also available free of charge from the **App Store**/**Google Play** for your mobile applications.

Download free of charge
from www.mobotix.com

No license fees!
Free updates!

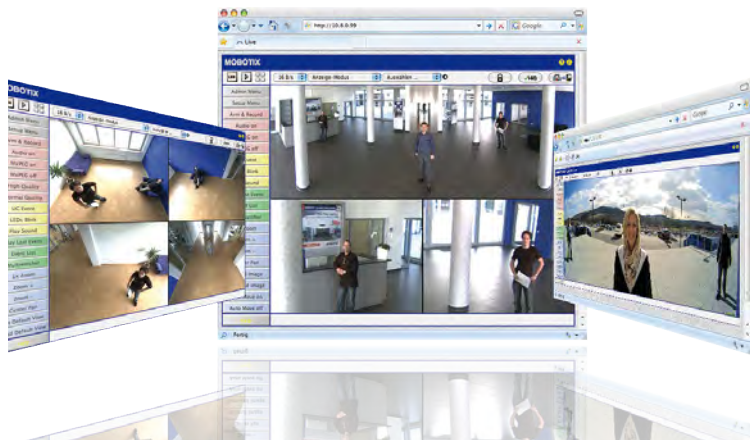

1.6.2 MxManagementCenter

MxManagementCenter (MxMC) is a completely new development that focuses on a unique and intuitive user experience. Single and double click, drag&drop, support of several screens and direct view of events and alarm messages are just some of the many advantages of the new software.

MxManagementCenter is perfectly designed in combination with MOBOTIX cameras representing the decentralized concept at its best. MxMC allows controlled recording access via the camera or later directly to the NAS.

A unique feature is the adaptive bandwidth management supporting quality search even over mobile networks with very limited bandwidth. MxMC is 100% free of charge, requiring no license or update costs and at the same time having no limits in terms of users, screens and cameras.

MxManagementCenter – simple operation of the most important camera functions:

- Integration of an unlimited number of cameras
- Camera groups with representation in Grid and Graphic views, Grid views with a focus window and many controls
- Optical and audible alarming of new events
- Instant Player that allows for quick viewing of the latest events during live video monitoring operation
- Easy use of multiple monitors by double-clicking on the live image, grid or event image
- Door station functions (intercom, open door, turn light on/off, etc.)
- Subsequent distortion correction of hemispheric camera images - in live images and in recordings



Download free of charge
from www.mobotix.com

No license fees!
Free updates!





1.6.3 MOBOTIX MxBell

Never miss another visitor, thanks to push notifications! Use MOBOTIX MxBell on your smartphone or tablet to receive notifications from the doorbell of a MOBOTIX IP Video Door Station and live views from MOBOTIX cameras. This app helps you open the door and enables hands-free talking, automatic camera search, a live view, camera connection via SSL and display of the connection status.

Our new MOBOTIX MxBell is here!

The update scores with its new playback function, which makes it possible to search through the recorded events for the integrated Door Stations and cameras at a specific time point and play back the individual clips. In addition, the Grid view will simultaneously display up to four cameras, which in particular is a great advantage for small installations.

- Never miss another visitor, thanks to push notifications.
- Displays doorbell messages from MOBOTIX IP Video Door Stations.
- Live views from MOBOTIX IP cameras with gesture-controlled PTZ function.
- Open the door from anywhere, hands-free talking.
- Automatic camera search, live view and camera connection using SSL.
- Displays the connection status.
- Supports remote connections and mobile data.
- iOS 11/Android 5.0 and higher

Free download from [App Store](#)/[Google Play](#)

No license fees!
Free updates!



2 INSTALLATION

The MOBOTIX M16 has been designed to be mounted on walls and ceilings. It can also be installed on a mounting pole using the appropriate MOBOTIX accessories. The different installation options are described in Section 2.3, «Mounting the Camera with Wall Mount» and the following sections, while the drilling templates are available on www.mobotix.com > Download Center > Documentation > Manuals.

2.1 Preparing the Installation

Before installing the MOBOTIX M16, the following questions should be answered:

1. Where will the camera be installed?
2. What other additional installation options are available?
3. How is the camera connected to the network and how is the power supplied?
4. How are the connections furnished from the building?
5. What cabling considerations are necessary?

The following sections in this chapter should answer all these questions. If anything is unclear or you have more questions, please contact your MOBOTIX partner or MOBOTIX Support directly. Contact information can be found at www.mobotix.com under Support.

2.1.1 Installation Options: Wall, Ceiling, Pole

Like all MOBOTIX cameras, the M16 is **extremely flexible** in terms of how and where it can be installed. An M16 can be used for both indoor and outdoor applications: in fixed or mobile applications – constantly changing locations or in/on vehicles of any kind. The M16 cameras have been certified **weatherproof according to IP66 IP66** and can work reliably in temperature ranges from -40 to 60 °C/ -40 to 140 °F (cold start min. temp. -30 °C/ -22 °F) without heating or fan. A practical weather and sun protective cover is integrated into the extremely resistant housing, which is made of UV-resistant special-purpose plastic.

Thanks to the camera's unique VarioFlex mounting system (supplied as standard), the M16 camera can be installed quickly and easily on any wall, ceiling or even a round pole of up to 18 cm in diameter (when combined with the stainless steel pole mount). The VarioFlex mounting system allows a wide range in both the horizontal and vertical directions (rotating and tilting) to enable precise adjustment to suit the area to be monitored. **The mount also fits directly over in-wall sockets (without the frame) and MOBOTIX interface boxes to fully conceal the cable, thus improving the security of the installation.**

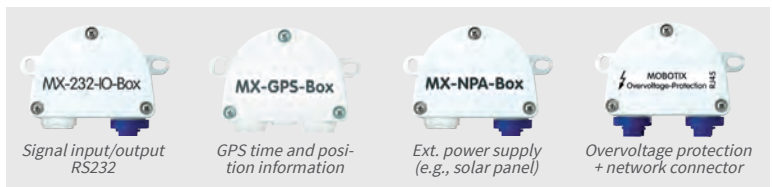

Preparing the Installation



The VarioFlex mount consists of a central joint, which is directly screwed into place with the M16 housing, and a wall and ceiling mount, which is fastened to the central joint with just one screw. In addition to being easy to install, the VarioFlex mount enjoys the advantage of featuring **completely concealed cabling** and high impermeability to water and dust (IP66). Wall and ceiling mounts are designed such that they can be installed over conventional in-wall sockets (without the frame) or cavity sockets and conceal them completely. A MOBOTIX interface box can be integrated in the wall mount.



VarioFlex wall mount with protected cabling and cover for in-wall sockets and MOBOTIX interface boxes

Make sure that you have found the best camera position before installing the camera. It is important that the camera's field of view is not obstructed in any way. Once the camera has been installed on a wall or ceiling, you can fine-tune its position. If the monitored area changes or the camera has to be installed in a different location, it is easy to exchange the camera's sensor modules and continue using the camera, without having to upgrade to new video software.

Wall Installation

The M16 can be installed on the wall of a building or structures, even mobile surfaces, for both indoor and outdoor use. The camera is mounted using the pre-installed **VarioFlex mount (supplied as standard)**, which is easily secured using the four enclosed screws and screw anchors (depending on the surface, it can also be mounted without screw anchors directly over the in-wall socket). The Ethernet connection cable of the camera has already been guided through the mount and simply needs to be connected with the network cable on-site (for example, using the MX-Patch-Box). By adjusting the VarioFlex mount as required, the captured image area can be precisely adjusted to the desired practical application. **The camera can be turned or tilted 180° horizontally and 80° vertically (from -60° to +20°).**

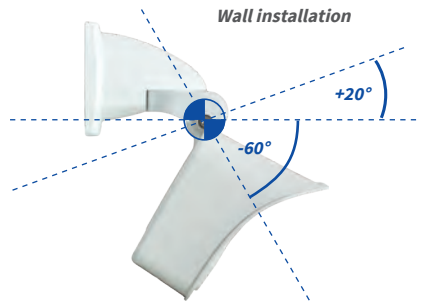

Wall installation

- Horizontal: 180°
- Vertical: -60° to +20°

Ceiling Installation

By exchanging the wall mount for the ceiling mount (delivered upon request), the M16 is ready to be **installed on ceilings in just a few easy steps** thanks to the VarioFlex system. This installation option is of particular benefit when monitoring rectangular rooms with a single camera. In such cases, the B041 sensor module with Super Wide-Angle lens allows the room to be monitored almost entirely by an M16 installed on the ceiling in one of the corners. Using the PTZ software, you can easily zoom in on image details in either the live image or the recording. **The camera can be turned or tilted 360° horizontally and 107° vertically (from -90° to +17°).**



Preparing the Installation

Installing on a Pole (With Accessories)

Installation on round poles is frequently used for cameras that are intended for mobile outdoor use (for example, surveillance of construction sites). For this purpose, MOBOTIX recommends using the pole mount, which is available for the M16 as an accessory and is almost indestructible (MX-MH-SecureFlex-ESWS). This pole mount is made from rust-proof stainless steel with a white coating and is used in combination with the pre-installed VarioFlex mount supplied as standard with the wall mount.

Poles with a diameter between 60 and 180 mm can be used. It is particularly advisable to use cavity (metal) poles, in which the network cable is not visible and can be protected from attacks. For more detailed information on the installation process, see Section 2.2, «First Installation Steps». The drilling templates are available on www.mobotix.com > [Download Center](#) > [Documentation](#) > [Manuals](#).



2.1.2 Installing the Camera with Hemispheric Sensor Modules

The camera must be correctly positioned on the wall or ceiling in order to be able to use the high-resolution hemispheric image display options of the M16 with B016 sensor module(s). The entire hemisphere of the room in front of the camera is then effectively monitored.

High-Resolution Panorama Images

The M16 with B016 sensor module(s) is primarily suited to providing an excellent overview in the form of a high-resolution panorama image, and less suitable for more exact details. For active operation, the camera should be installed at an (out of direct reach) height ranging from 2.5 m to 3.5 m. People, for example, may be identified very well at distances of up to 1.5 m and with sufficient detail at up to 3 m. Objects can be detected even at distances of 5 m and more from the camera. During installation, ensure that the camera is focused on the most important areas of the room as directly as possible in order to optimize image quality and provide the desired level of detail recognition. This applies above all to wall and ceiling installations that must be carried out at greater heights for technical or other reasons (over doors, windows, etc.). The lens capabilities can be only fully utilized by tilting the camera appropriately.

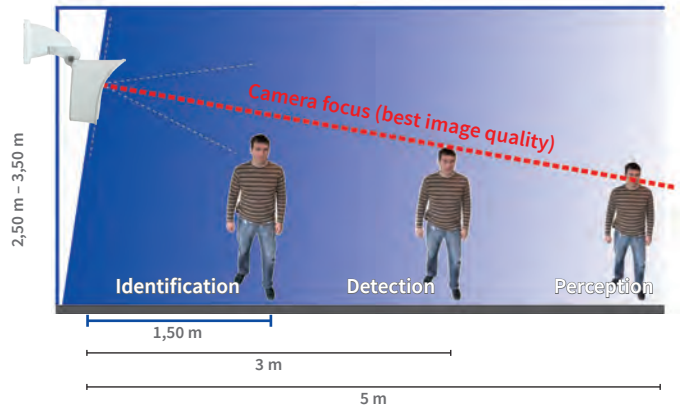

MOBOTIX recommendation



MOBOTIX original 180° Panorama image (B016 sensor module)

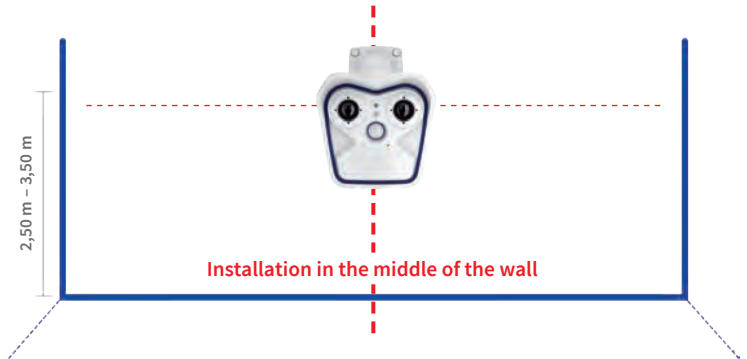

Allround View

A single M16 sensor module can monitor an entire room right into each of the four corners (360° Panorama View) thanks to its hemispheric lens. The camera should ideally be positioned on the ceiling in the center of the room. Rooms with a square floor area of up to approx. 40 m² generally allow the recognition of detail even at the borders of the full image. Rooms with up to 100 m² of floor area can be monitored using one single camera if you only want to monitor specific objects or to know if persons enter a room.

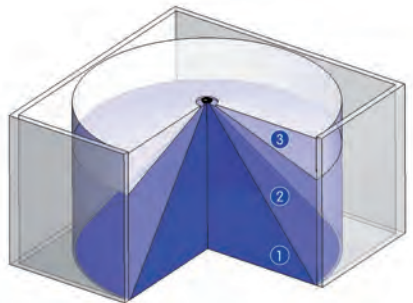

The **image quality** (precision) diminishes as the distance of an object to the camera focus point increases: 1 very good, 2 good, 3 satisfactory

Capture of entire room

Preparing the Installation

Furthermore, the “camera view from top to bottom” can also be achieved by installing the camera on a wall or a pole at a tilt of 90°.

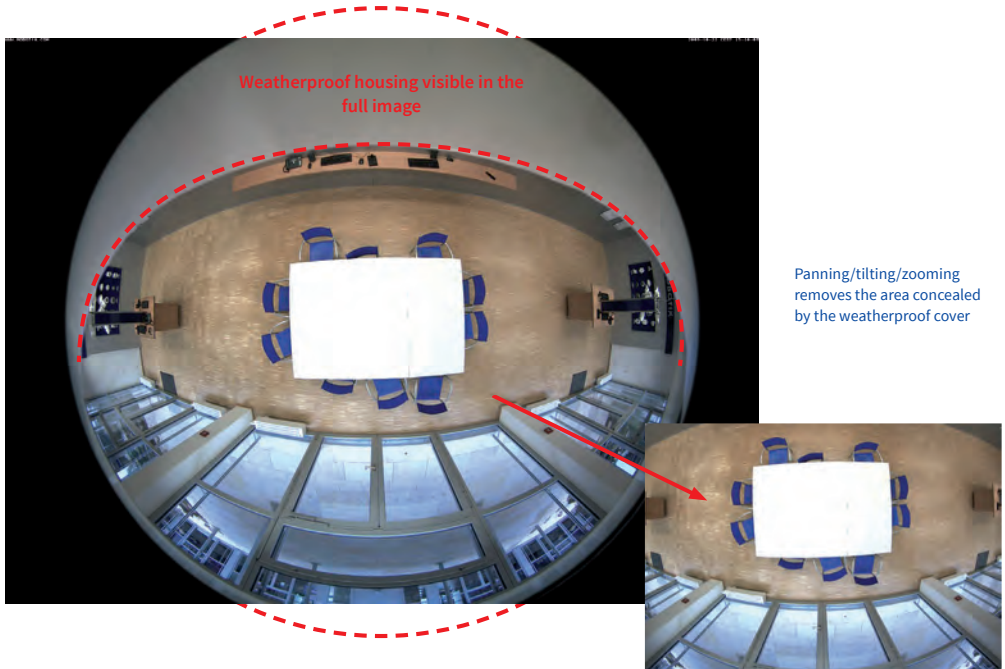

Note

Part of the captured image area is concealed behind the protective cover of the M16 housing, especially in the full image. For this reason, M16 cameras with B016 lens should be adjusted so that the concealed areas are not those that are supposed to be monitored. The concealed area can be completely removed from the image by panning/tilting/zooming the image using the virtual PTZ function.

2.1.3 Network Connection and Power Supply, UPS

Power-Over-Ethernet (PoE Conforming to IEEE 802.3af)

The M16 supports Power-over-Ethernet according to IEEE 802.3af (PoE)

All M16 models are supplied with power using the PoE standard. The PoE Adapter Set (MX-NPA-PoE-Set) may be used for smaller installations, or the weatherproof PoE injector MX-NPA-Box (MX-OPT-NPA1-EXT) may be used in outdoor scenarios. For larger installations, we recommend investing in a PoE-capable supply device available on the market. Section 2.7 contains more information on the possible combinations of connecting the M16 and power supply options.



The PoE adapter replaces the crossover cable when directly connecting to a computer

The **maximum length** of the network cable for power supply over an Ethernet cable is **100 m/110 yd**. The Mx2wire+ media converter set (available as an accessory) can be used to extend the range of an Ethernet connection up to 500 m in length (maximum transmission speed for a 500 m/550 yd cable: 45 Mbps and 12 W for the PoE device).



Note

The MOBOTIX M16 can be powered by switches or routers that support the PoE (Power-over-Ethernet) standard and conform to IEEE 802.3af.

Advantages of PoE power supply:

- Centralized backup power supply available via network
- Lower, more cost-effective power consumption
- Camera does not require an additional network connection

Preparing the Installation

Using Uninterruptible Power Supplies (UPS)

You should install an uninterruptible power supply (UPS) in order to maintain a continuous power supply even when utility power fails. These devices also provide full protection against electrical surges and voltage fluctuations, enhancing the reliability of the system as a whole.

When using a more powerful 19" rack-mounted UPS, you can also protect all other network components (for example, switches, routers, PoE switches, etc.).

Since MOBOTIX cameras do not require any heating, even during winter, the average power consumption of less than 5 watts is very low. This, in turn, means that you can centralize the UPS-protected power supply by injecting power into the Ethernet cables (max. 100 m). This kind of protected power supply can be used either with MOBOTIX PoE products (MX-NPA-PoE + Universal Power Supply) or with PoE-compliant switches according to IEEE 802.3af.

UPS units not only protect the camera against power failures, they also protect all other connected network devices against damage from voltage peaks and lows



2.1.4 Providing the Camera Connections, MX-Overvoltage-Protection-Box

Once the camera position, the position of the cable outlets and the method of power supply have been decided upon, the cabling can be installed. Before installing the MOBOTIX M16, you should make sure that the network connections have been thoroughly tested so that the proper functioning of the camera is guaranteed.

If the camera is to be installed outdoors, you should also install the MOBOTIX MX-Overvoltage-Protection-Box (optional accessory). This interface box not only provides **overvoltage protection of up to 4 kV for MOBOTIX IP cameras**, it also provides simple and weatherproof connection of the cameras to a network patch cable (-RJ45 variant) or a network installation cable (-LSA variant).

For additional information on the MX-Overvoltage-Protection-Box, open the **Product Selector > Accessories > Interface Boxes** section on www.mobotix.com.



2.1.5 Wiring, Fire Prevention, Lightning and Surge Protection

When installing the wiring inside or outside of buildings, make sure you always adhere to the relevant regulations on wiring, fire prevention, and protection against lightning.

MOBOTIX cameras are protected against the effects of small electrical surges by a range of measures. These measures, however, cannot prevent the camera from being damaged when stronger electrical surges occur. Particular care should be taken when installing the camera outside to ensure proper **protection against lightning**, as this also protects the building and the entire network infrastructure.

MOBOTIX recommends having MOBOTIX cameras installed only by certified specialists accustomed to installing network devices and having proper respect for the applicable regulations regarding lightning protection and fire prevention as well as the current technology for preventing damages from electrical surges.

Wiring

When installing the wiring, make sure to follow these guidelines:

- **Data cable:** Make sure you only use double-shielded Cat 5 or higher cable (S/STP) for Ethernet connections.
- **Outdoors:** Installing the camera outdoors requires special precautions and measures regarding the cables as well as lightning and surge protection.
- **Wire lengths:** The cable segments must not exceed the maximum allowed cable lengths in order to ensure proper data transfer.
- **Avoiding induction:** When running data cables parallel to existing regular power lines or high-voltage wires, make sure you observe the minimum distances to the power cables.



Fire Prevention

When installing the power lines to the camera, make sure you always adhere to the country-specific regulations (for example, VDE in Germany, IEEE in the U.S.) in effect on wiring and fire prevention at the site of the installation.

Lightning and Surge Protection

In order to avoid damage to MOBOTIX cameras from overvoltages, you should always install the MX-Overvoltage-Protection-Box. This competitively priced and weatherproof network connector provides reliable protection against overvoltages of up to 4 kV; the box is easily installed in the Outdoor Wall Mount, for example (see Section 1.5.7, «MX-Overvoltage-Protection-Box»).



2.2 First Installation Steps

2.2.1 Initial Installation of the Sensor Modules (Except M16 Complete Cameras)

Not required with M16 Complete Camera (see Section 1.4.6)

The MOBOTIX M16 cameras are delivered with a pre-assembled housing as **M16 Body** camera. The sensor modules (consisting of lens carrier, image sensor and lens) need be ordered separately. Upon delivery, the sensor module sockets in the front element are fitted with transport plugs. When operating the camera, it needs to be fitted either with sensor or blind modules. This closes off the front element and protects the camera against foreign objects, insects and water.

Caution

Only replace the sensor modules when the camera is disconnected from the power supply. Make sure the power supply to the camera is disconnected before installing or replacing sensor modules.

When installing the sensor modules, make sure that the sensor module cables and the patch cable are not damaged or bent sharply.

Using One or Two Sensor Modules

With an M16, you have the choice of using the camera with one or two sensor modules. Since the modules are easily exchanged, it is also possible to add a module or to use different ones later on.



MOBOTIX Tutorials:
www.mobotix.com/en/support/download-center/documentation/brochures-guides

Caution

Note that you must not operate the M16 with installed transport plugs, since the camera is not protected against the environments:



M16 with two transport plugs:
No operation allowed!



M16 with one transport plug:
No operation allowed!



M16 with one blind module:
Unrestricted operation (IP66)



Transport plug



Procedure

1. **Prepare the sensor module:** Remove the plastic lock nut (this is not needed any more). Remove the bayonet catch by rotating it counter-clockwise, then remove the blue rubber plug.

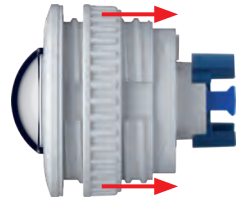

2. **Remove the transport plugs:** Gently pull the two transport plugs out of the sensor module sockets by lifting the rim of the plugs. Now pull the connectors of the sensor module cables out of the back of the transport plugs; take care not to damage the connectors or the cables. **Make sure that you do not pull the sensor module cables out of the housing!**



3. **Connect sensor module cable:** Firmly push the sensor module cable into the module's connector as shown in the figure.



4. **Lock sensor module cable:** Apply bayonet catch as shown and turn it clockwise until it gently snaps shut.



5. **Insert the sensor module:** Make sure that the MOBOTIX lettering on the sensor module is at the "9 o'clock" position as shown in the figure.



First Installation Steps

6. **Lock the sensor module:** Using the black module wrench, turn the sensor module clockwise until it stops.



Repeat steps 3 to 6 for the second sensor module or the blind module, respectively. **Installing the blind module is a mandatory prerequisite when using the M16 as a mono camera with only one sensor module.**



Blind module

Caution

Note that the sensor modules are not yet protected against theft and unwanted rotation (e.g., due to vibration). In such a case, it is **highly recommended to install the security clips (M.11):**

- Section 2.2.2, «Opening the Camera Housing»
- Section 2.2.3, «Installing the Security Clips (Optional, Not Required for M16 Complete Cameras)»
- Section 2.2.8, «Closing the Camera Housing»



2.2.2 Opening the Camera Housing

The following tasks require opening the camera housing and removing the front element of the M16 in order to get to the interior of the M16:

- Inserting security clips at the sensor module or the blind module, respectively.
- Exchanging the MOBOTIX Ethernet patch cable against a longer MOBOTIX patch cable.
- Connecting an MxBus* two-wire cable in order to attach MxBus extension modules (e.g., the «MX-GPS-Box»).
- Connecting a MOBOTIX USB cable in order to attach external data storage devices or an «MX-232-IO-Box».
- Exchanging the pre-installed MicroSD card against a larger one or as preventive maintenance measure (see Section 3.5, «MicroSD Card Recording»).



*Only supported by Mx-M16B variant

Procedure

1. Place the camera face-down on a clean and dry surface.
2. Remove the two rubber plugs at the back of the camera housing.
3. Using the supplied 5 mm Allen wrench, loosen the two bolts at the back of the camera housing. Leave the bolts and washers in the camera housing.
4. Using the Allen wrench, **cautiously** push from behind **in an alternating fashion** onto the left and the right bolt (red arrow in upper figure) and push the front element out of the front of the housing.
5. Tilt the front element forward as shown in the figure.



Remove rubber plugs at the back of the housing using small screwdriver



Not required with M16 Complete Camera (see Section 1.4.6)

2.2.3 Installing the Security Clips (Optional, Not Required for M16 Complete Cameras)

The security clips are protecting the sensor modules or the blind module in the front element of the M16 against unwanted rotation (e.g., due to vibration when mounted on a pole or in an automotive scenario).



Procedure

1. **Open camera housing:** Open the camera housing as described in Section 2.2.2.
2. **Insert the security clips:** To protect the modules against unwanted rotation insert the two red security clips at the insides of the sensor modules (as shown in the figure). Make sure that the security clips click into place as shown in the image detail.
3. **Close camera housing:** Close the camera housing as described in Section 2.2.8.

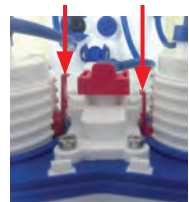

First Installation Steps

2.2.4 Exchanging Sensor Modules

Note that you only need to follow this procedure if the security clips (M11) have been installed. Since the sensor modules cannot be exchanged from the outside in such a case, you need to remove the front element, replace the sensor modules and install the front element again. If no security clips have been installed, you can exchange the sensor modules as described in Section 2.2.1, «Initial Installation of the Sensor Modules (Except M16 Complete Cameras)».

Procedure

1. **Open camera housing:** Open the camera housing as described in Section 2.2.2.
2. **Remove the security clips:** The sensor or blind modules may have been protected against unwanted rotation by applying the security clips. Push the top of the security clip in the direction of the blue arrow (see figure in the side note) so that it can pass the notch and pull the clip upwards.

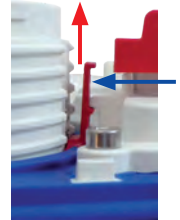
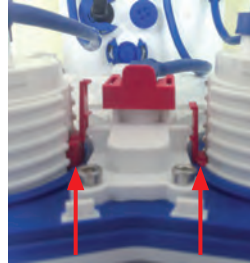

3. **Remove the sensor module cable from the sensor or blind module:** The sensor module cables are secured using a special cable lock with bayonet catch. To remove the bayonet catch turn it counter-clockwise until it gently snaps open. Take off the catch and pull out the cable.



4. **Remove the sensor or blind module:** Set the black module wrench onto the sensor or blind module, so that the two notches lock into the two holes of the module (at the 12 and 6 o'clock positions). Turn module wrench counter-clockwise by 90 degrees until it stops.



Push the sensor or blind module out of its socket.

5. **Prepare the new sensor module:** Remove the plastic lock nut (this is not needed any more). Remove the bayonet catch by rotating it counter-clockwise, then remove the blue rubber plug.

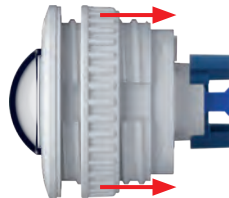

6. **Connect the sensor module cable to the sensor module:** Guide the cable through the opening in the front element and firmly push the sensor module cable into the connector. Apply bayonet catch as shown and turn it clockwise until it gently snaps shut.



7. **Insert the sensor module:** Make sure that the MOBOTIX lettering on the sensor module is at the “9 o’clock” position as shown in the figure. Using the black module wrench, turn the sensor module clockwise until it stops.



8. **Insert the security clips:** To protect the modules against unwanted rotation insert the two red security clips at the insides of the sensor modules (as shown in the figure). Make sure that the security clips click into place as shown in the image detail.

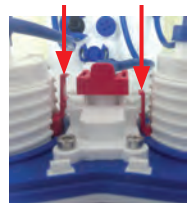

9. **Close camera housing:** Close the camera housing as described in Section 2.2.8.

2.2.5 Replacing the Ethernet Patch Cable

If you want to replace the pre-installed MOBOTIX patch cable (0.5 m/20 in) by a longer one, make sure that you only use genuine MOBOTIX cables (see Section 1.5.5, «Ethernet Patch Cable for Bayonet Catch»).

Procedure

1. **Open camera housing:** Open the camera housing as described in Section 2.2.2.
2. **Remove the patch cable:** Turn the bayonet catch of the patch cable at the inner housing cover (red circle in figure) counter-clockwise and remove the catch.

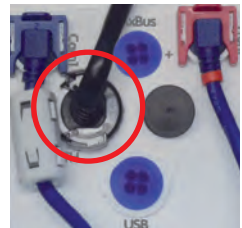

First Installation Steps

3. **Remove hinged ferrite and pull out cable:** Remove the hinged ferrite from the patch cable by cautiously opening the two latches with a small screw driver. Gently pull the patch cable out of the housing (you may have to remove the foot of the wall mount to be able to do this).



4. **Attach ferrite at the new patch cable:** Attach the hinged ferrite at the new patch cable, leaving a space of exactly 70 mm/2.8 in between the sealing of the plug and the ferrite.

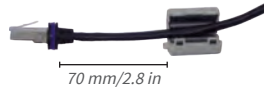

5. **Guide the patch cable into the housing:** Guide the new cable from the front through the cable guide in the hinge of the VarioFlex mount (see figure). Reinstall the foot of the wall mount if you removed it in step 3.



In order to ensure the weatherproofness of the M16, make sure that you only use genuine MOBOTIX patch cables!

6. **Connect the patch cable:** Insert the plug of the Ethernet cable into the appropriate connector. Apply bayonet catch as shown and turn it clockwise until it gently snaps shut.

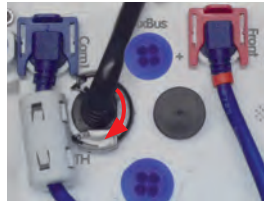

7. Make sure that the hinged ferrite rests between the inner housing cover and the cable guide at the top of the housing as shown.

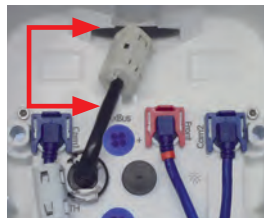

8. **Close camera housing:** Close the camera housing as described in Section 2.2.8.

2.2.6 Connecting a USB Cable

Only use USB cables with angled plugs for connecting USB cables to the M16!



Using the USB plug (red circle in figure), you can attach existing expansion modules, such as the MOBOTIX ExtIO (USB), the MX-232-IO-Box or external USB hard drives to the camera in a weatherproof and well-protected manner.

Procedure

1. **Open camera housing:** Open the camera housing as described in Section 2.2.2.
2. **Remove the single wire plug:** Remove the blue single wire plug (red circle in figure).
3. **Guide the USB cable through the housing:** Guide the cable from the front through the cable guide in the hinge of the VarioFlex mount (see figure).
4. **Connect the USB cable:** Insert the MiniUSB plug into the appropriate connector. Apply bayonet catch as shown and turn it clockwise until it gently snaps shut.
5. **Close camera housing:** Close the camera housing as described in Section 2.2.8.

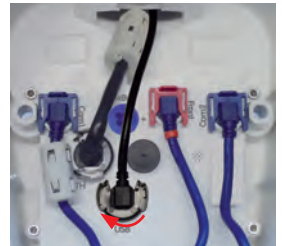
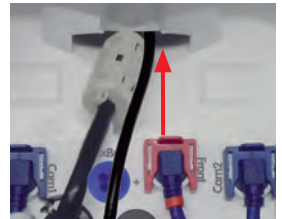
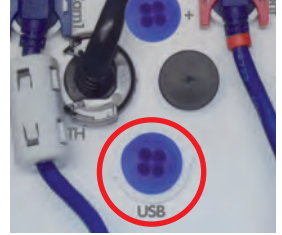

First Installation Steps

2.2.7 Connecting a Two-Wire MxBus* Cable

*Only supported by Mx-M16B variant

You can use such a cable to connect additional MOBOTIX modules (e.g., the MX-GPS-Box or the MX-232-IO-Box) to the M16.

Note that you can attach two MxBus cables (each having two wires) to the MxBus connector (red circle in figure). Take care not to switch the polarity of the wires. It is recommended to use the same wire color for +/– for the entire MxBus system (e.g., red = +, blue = –).

The length of the entire MxBus wiring must not exceed 50 m/55 yd.

Procedure

1. **Open camera housing:** Open the camera housing as described in Section 2.2.2.
2. **Prepare the MxBus wires:** Remove the blue single wire plug. Strip 5 mm (1/5 in) of insulation from the wire ends, then push each wire into one of the four holes in the single wire plug (this prevents humidity from entering the camera).
3. **Connect MxBus wires:** Push back the blue single wire plug so that you can easily attach the MxBus wires. Attach the MxBus wires by firmly pushing the wires into the corresponding connectors. Carefully press the single wire plug into the connector socket and twist the MxBus wire pairs.

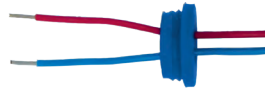
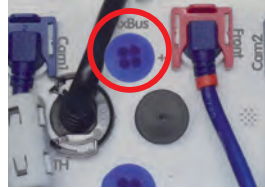

Single-wire plug



MxBus connector

If you need to remove one of the wires, you need to unlock the connector by pressing on the orange-colored area using a small screwdriver, then pull out the wire.

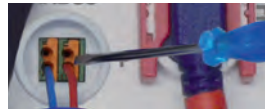

4. **Guide the MxBus cable out of the housing:** Guide the cable from the front through the cable guide in the hinge of the VarioFlex mount (see figure).
5. **Close camera housing:** Close the camera housing as described in Section 2.2.8.

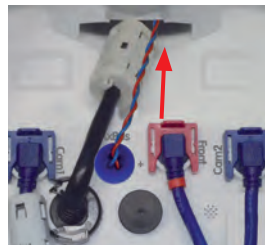

Notes

After you have connected an MxBus module, you need to activate it in the camera's browser interface (**Admin Menu > Manage Hardware Expansions** or **Manage MxBus Modules**, respectively).

2.2.8 Closing the Camera Housing

Once you have completed the tasks in the interior of the M16, you need to reassemble the front element of the M16. Make sure that you are reconnecting all plugs as shown in the figure if you removed any of them:



Procedure

1. Before inserting the front element, make sure that the sensor module cables of both image sensors are running at the **inside** of the screw bore (see red arrow). **The sensor cables must not run along the outside of the screw bores (see figure below)!**



First Installation Steps

2. Place the camera on its right side (as seen by the camera) as shown. Push the cable of the left sensor module under the retaining lug at the screw bore (red circle in detail figure)



3. Push the front element into the housing and make sure that the sensor module cable remains under the retaining lug (red circle in detail image).

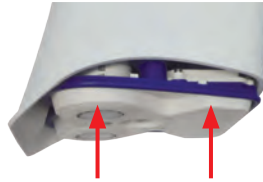

4. Continue to push the front element into the housing, then evenly press the front element into the housing at the spots indicated by the red arrows.



5. Using the supplied 5 mm Allen wrench, tighten the two bolts at the back of the camera housing. Push the two rubber plugs back into the opening of the screws to prevent humidity and dirt from entering the camera.



Do not forget to apply rubber plugs at the back of the housing!

2.3 Mounting the Camera with Wall Mount



The M16 is an allround camera designed for use in indoor and outdoor applications. The camera must always be installed with the VarioFlex mount, which has been prepared at the factory for wall mounting and allows the cabling to be concealed. The best camera position for the selected lens must be found before installing the camera on the wall (see Section 2.1.1, «Installation Options: Wall, Ceiling, Pole» and Section 2.1.2, «Installing the Camera with Hemispheric Sensor Modules»). You can fine-tune its position once the camera has been installed on the wall.

2.3.1 VarioFlex Wall Mount

Using the VarioFlex wall mount, the camera can be precisely panned, both **horizontally** and **vertically**, to suit the area that is to be monitored.

When installed on a wall, the camera can be turned or tilted as follows:

- horizontally: 180°
- vertically: 80°

Tilting the camera when installed on a wall:

- Horizontal: 180°
- Vertical: 80°

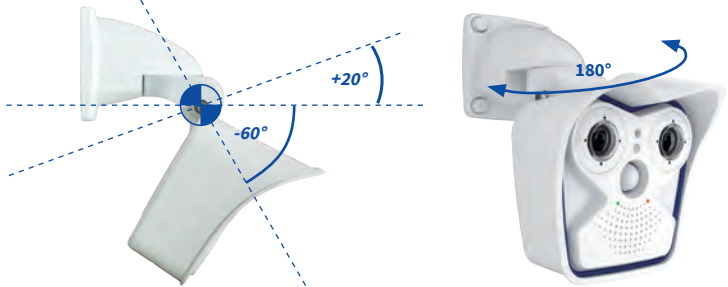

Mounting the Camera with Wall Mount

In order to ensure a flush finish with the surface, connect the camera patch cable to the **network cable using a standard adapter** that is protected in the wall mount or a MX-Patch-Box that can easily be inserted into the cavity socket of the wall mount (VarioFlex mount). For more information on the MX-Patch-Box, please visit www.mobotix.com and go to the **Product Selector > Accessories > Interface Boxes** section. It is also possible to **install an in-wall socket with RJ45 connector**. When doing so, make sure that the in-wall socket is placed as high up in the wall mount housing as possible.

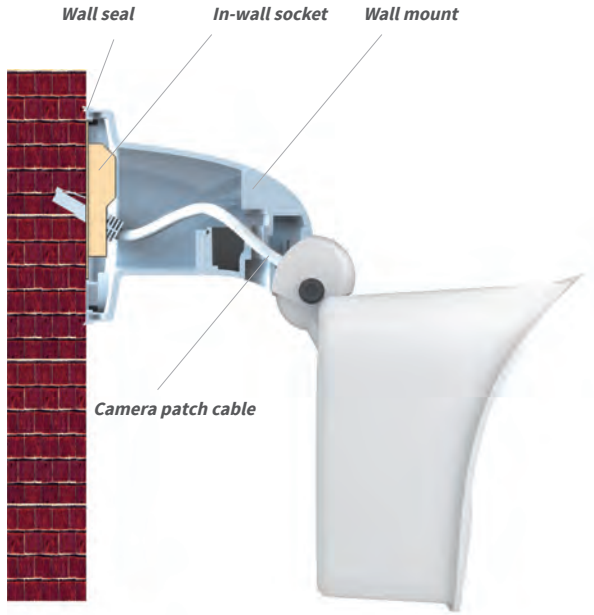

MX-Overvoltage-Protection-Box
the wall mount



When installing **on-wall cabling**, breaking out one of the four possible openings in the base of the wall mount with a pliers will ensure that the cables can be fed neatly into the camera. The connection to the camera patch cable can be established using a suitable adapter within the wall mount.

Caution: *If using the camera outdoors, only use the opening at the bottom of the mount to prevent water from entering the mount!*



Pliers to break through
a cable guide



Procedure

1. **Install and prepare the network connection:** The pre-installed patch cable attached to the camera must be connected with the on-site network cable. The connection can either be established using an installed in-wall socket with RJ45 connector or, in the case of a protruding network or patch cable, using the MX-Patch-Box. In both cases, the connection is well protected and is neither accessible nor visible from the outside.



No screw anchors are required for wooden surfaces

2. **Drill the holes:** Use the drilling template for the camera (available on www.mobotix.com > Download Center > Documentation > Manuals or, if used, the extended drilling template included in the MX-Patch-Box package). Drill the holes for the supplied screw anchors. Screw anchors do not have to be fitted if the surface is made of wood. To secure the mount, the supplied stainless steel hex head screws will be screwed directly into the surface later on. You should start with a 2-mm drill bit, for example (drilling depth just slightly less than screw length), in order to facilitate screwing in wood.

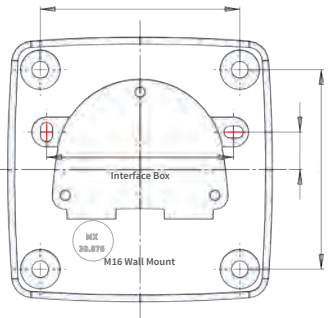

3. **Attach wall seal:** Place the white rubber sealing ring with the groove on the edge of the wall mount.



Additional sealing possible, for example, with shrink tubing



4. **Connect the cable:** Connect the on-site network cable to the camera patch cable using an adapter or insert the patch cable into the RJ45 outlet. Take note of the installation manual included in the package when using a MX-Patch-Box. All manuals can be downloaded and printed (as PDF files) from the MOBOTIX website (www.mobotix.com) in the **Support > Download Center > Documentation > Manuals** section. Make sure that the cables are not bent or squashed.



Mounting the Camera with Wall Mount

5. **Mount the camera:** Place the wall mount over the drill holes and hold it against the wall. Then use the four screws each with a washer and tighten them using the appropriate wrench. Do not overtighten the screws as this may damage the plastic mount. Check that the screws are securely in place and place the white caps on the screw heads. Then aim the camera as described in Section 3.3.



Screw caps for lock screws

6. **Clean sensor modules:** Clean the protective glass and the dome of the sensor modules with a clean soft cotton cloth for optimal image results.



7. **Establish a connection to the camera, check the image:** Establish a connection to the camera as described in Section 3.1, «Manual and Automatic Operation – Overview» and the following sections. The live image from the camera should be visible on the computer monitor. Check image sections on the computer monitor.

Note

The **VarioFlex mount** and **ceiling mount** must always be used for **ceiling installation** (see Section «Ceiling Installation»).

2.4 Mounting the Camera with Ceiling Mount*



The M16 is an allround camera designed for use in indoor and outdoor applications. The camera is always installed together with the VarioFlex mount, which is shipped as a wall mount, but can be converted to a ceiling mount in just a few steps. The best camera position for the selected lens must be found before installing the camera on a ceiling, an overhang or balcony (see Section 2.1.1, «Installation Options: Wall, Ceiling, Pole» and Section 2.1.2, «Installing the Camera with Hemispheric Sensor Modules»). You can fine-tune its position once the camera has been installed on the ceiling.

***Only included if this had been specified when ordering the camera!**

2.4.1 VarioFlex Ceiling Mount

Using the VarioFlex ceiling mount, the camera can be precisely panned, both **horizontally** and **vertically**, to suit the area that is to be monitored.

When installed on a ceiling, the camera can be turned or tilted as follows:

- horizontally: 360°
- vertically: 107°

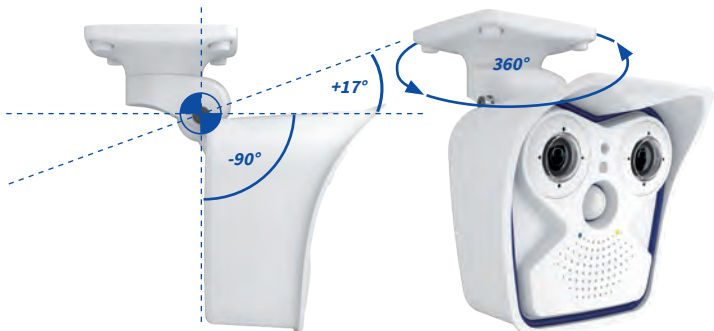

Tilting the camera when installed on a ceiling

- Horizontal: 360°
- Vertical: 107°

Mounting the Camera with Ceiling Mount*

In addition, a cavity or in-wall socket can be installed for the network cable protruding from the ceiling, which allows sufficient space to use a standard adapter to connect the network cable with the camera patch cable.

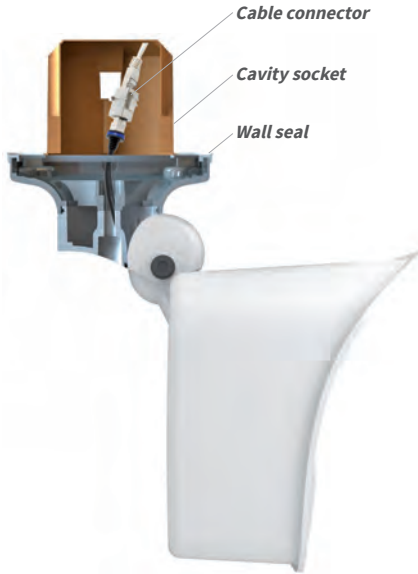

Standard adapter for cable connection

Additional sealing of the wall mount with silicone (on the wall seal) is recommended for use with uneven surfaces

When installing **on-wall cabling**, breaking out one of the four provided openings in the base of the ceiling mount will ensure that the cables can be fed neatly into the camera. The camera patch cable must be connected with the network cable using a suitably sealed adapter.

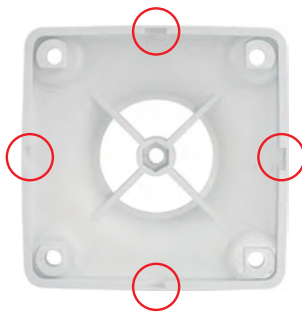

Pliers to break through a cable guide



Procedure

1. **Convert to a ceiling mount:** Simply remove the lock screw on the central joint and exchange the wall mount for the supplied ceiling mount. Before fastening the ceiling mount to the central joint (using the screw of the wall mount), the patch cable is guided through one of the four openings.



2. **Install and prepare the network connection:** Guide the pre-installed camera patch cable through one of the four openings in the ceiling mount (this will be connected later with the network cable using a suitable adapter, for example, in an existing cavity socket).

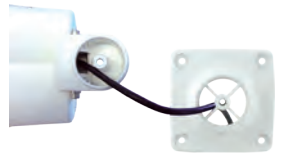

No screw anchors are required for wooden surfaces

3. **Drill the holes:** Use the drilling template for the camera (available on www.mobotix.com > Download Center > Documentation > Manuals). Drill the holes for the supplied screw anchors. Screw anchors do not have to be fitted if the surface is made of wood. To secure the mount, the supplied stainless steel hex head screws will be screwed directly into the surface later on. You should start with a 2-mm drill bit, for example (drilling depth just slightly less than screw length), in order to facilitate screwing in wood.

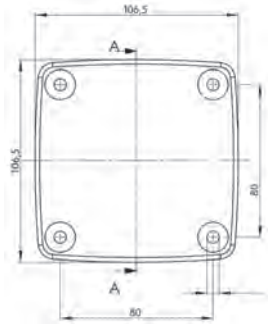

Additional sealing possible, for example, with shrink tubing

4. **Attach ceiling seal:** Place the white rubber seal with the groove on the edge of the ceiling mount.
5. **Connect the cable:** Connect camera patch cable via connector. Make sure that the cable is not bent or squashed.



Mounting the Camera with Ceiling Mount*

6. **Mount the camera:** Place the ceiling mount over the drill holes, use the four screws each with a washer and tighten them using the appropriate screwdriver. Do not overtighten the screws as this may damage the plastic mount. Check that the screws are securely in place and place the white caps on the screw heads. Then aim the camera as described in Section 3.3.



Screw caps for lock screws

7. **Clean sensor modules:** Clean the protective glass and the dome of the sensor modules with a clean soft cotton cloth for optimal image results.



8. **Establish a connection to the camera, check the image:** Establish a connection to the camera as described in Section 3.1, «Manual and Automatic Operation – Overview» and the following sections. The live image from the camera should be visible on the computer monitor. Check image sections on the computer monitor.

Note

The **VarioFlex mount** and **wall mount** must always be used for **wall installation** (see Section 2.3, «Mounting the Camera with Wall Mount»).

2.5 Mounting the Camera with Pole Mount (Accessories)



If you are intending to install the camera on a pole, you should consider using the MOBOTIX M16 pole mount. This mount is made of 3-mm powder-coated stainless steel (white) and has been designed specifically for outdoor use. The supplied stainless steel straps allow the mount to be attached to poles with diameters between 60 mm and 180 mm. By design, the pole mount does not allow the use of an in-wall socket. We recommend using an MX-Patch-Box that can be easily inserted into the cavity socket of the wall mount (VarioFlex mount) in order to ensure a weatherproof connection of the network devices. For more information on the MX-Patch-Box, please visit www.mobotix.com and go to the **Product Selector > Accessories > Interface Boxes** section.

The camera is always installed together with the VarioFlex mount, which is shipped as a wall mount, and can also be installed directly on the pole mount. The best camera position for the selected sensor module must be found before installing the camera (see Section 2.2, «First Installation Steps»). You can fine-tune its position once the camera has been installed on the wall.



Mounting the Camera with Pole Mount (Accessories)

2.5.1 Pole Mount (MX-MH-SecureFlex-ESWS)

When mounted to a pole, the camera can be turned or tilted similar to wall installations:

- horizontally: 180°
- vertically: 80°

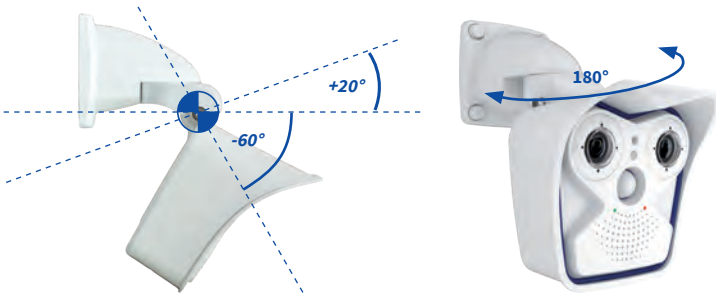

Tilting the camera when installed on a pole

- Horizontal: 180°
- Vertical: 80°

If the wall mount is rotated by 90 degrees, you can also point the camera all the way down:

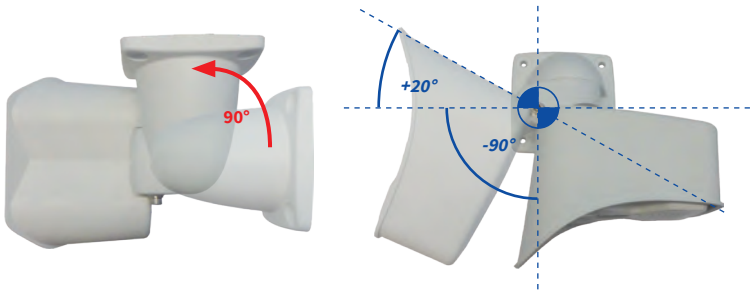

Pole Mount Dimensions



Scope of Delivery and Required Parts

Please first check that all the components supplied with the corner and pole mount set are present in the original packaging.

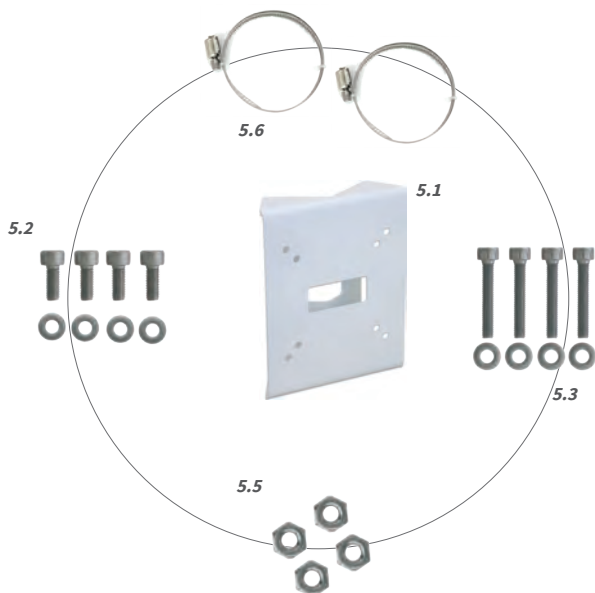

Item	Number	Part Name
5.1	1	Pole mount
5.2	4	Stainless steel hex head screws M6x20 mm
5.3	4	Stainless steel hex head screws M6x35 mm (not required)
5.4	8	Stainless steel washers
5.5	4	Stainless steel hex nuts M6
5.6	2	Stainless steel straps



Screw caps for lock screws

The caps for the screws are also required here. These are included in the delivery of the M16 basic module (see Section 1.4, «Delivered Parts and Dimensions», item M.10).

Mounting the Camera with Pole Mount (Accessories)

Procedure

1. **Prepare the cable:** Guide the on-site network cable from behind through the middle opening of the pole mount. Ideally, the cable should be guided directly from the pole into the cavity socket of the VarioFlex wall mount, where it is connected with the camera patch cable (concealed cabling) via an adapter (such as MX-Patch-Box).



2. **Prepare the straps:** Guide the two stainless steel straps through the pole mount. The pole must have a diameter between 60 mm and 180 mm.



3. **Attach pole mount:** Place the straps around the pole and tighten them using a screwdriver. If necessary, the ends of the straps can be cut off.



4. **Attach rubber sealing ring:** Place the white rubber sealing ring with the groove on the edge of the wall mount.



5. **Connect the cable:** Connect the on-site network cable to the camera patch cable using an adapter or insert the patch cable into the RJ45 outlet. Take note of the installation manual included in the package when using a MX-Patch-Box. All manuals can be downloaded and printed (as PDF files) from the MOBOTIX website (www.mobotix.com) in the **Support > Download Center > Documentation > Manuals** section. Make sure that the cables are not bent or squashed.





Screw caps for lock screws

- Mount the camera:** Place the wall mount over the predrilled positions in the pole mount and tighten it using the supplied M6x25 mm screws (item 1.2), washers (item 1.4) and M6 hex nuts (item 1.5). Place the white caps on the screw heads. Then aim the camera as described in Section 3.3.



- Clean sensor modules:** Clean the protective glass and the dome of the sensor modules with a clean soft cotton cloth for optimal image results.



- Establish a connection to the camera, check the image:** Establish a connection to the camera as described in Section 3.1, «Manual and Automatic Operation – Overview» and the following sections. The live image from the camera should be visible on the computer monitor. Check image sections on the computer monitor.

Note

The **VarioFlex mount** and **wall mount** must always be used for **pole installation**. The VarioFlex ceiling mount should **not** be used.

2.6 Replacing the MicroSD Card

The camera must be taken down to remove, insert, or replace a MicroSD card in use. To avoid data loss, be sure to deactivate MicroSD card recording in the camera software and reboot the MOBOTIX camera before removing the card.

Caution

A MicroSD card may only be removed from the camera after you have deactivated recording to the SD card and rebooted the camera. Failing to do so may lead to data loss! Make sure that the card is not write-protected!

Procedure



1. **Deactivate recording:** Recording to the SD card must be deactivated (**Admin Menu > Storage on External File Server/Flash Device**). If the MicroSD card recording is still active, deactivate recording, reboot the camera and then disconnect its power supply. For more information, see Section 3.5, «MicroSD Card Recording».
2. **Open camera housing:** Open the camera housing as described in Section 2.2.2.
3. **Remove connection cable from the inner cover of the housing:** Remove the connector of the sensor cable and the I/O cable (red clips) after opening the clip catches. Remove Ethernet cable and any connected MiniUSB cable after opening the bayonet catch. Remove MxBus cables. Make sure the front element with the sensor modules does not fall down.
4. **Remove inner cover:** Remove the four lock screws on the inner lid (red arrow) using the supplied 2.5-mm Allen wrench and carefully lift off the lid.

Make sure that the interconnections between the inner lid and the circuit board are not damaged when removing the inner lid.



The MicroSD card is located at the bottom in the center of the circuit board.

Make sure not to touch the circuit board when replacing the MicroSD card!



5. **Unlock MicroSD card:** *Carefully* slide the metal latch to the right (using your fingernail).

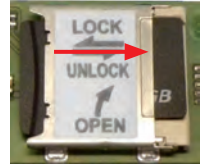

6. **Remove the MicroSD card:** Lift the metal latch upwards and to the right and remove the SD card.

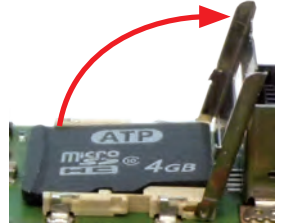

7. **Insert and lock the MicroSD card:** Insert the MicroSD card and close the metal latch. Gently slide the metal latch (using your fingernail) back to the left to lock the MicroSD card.



8. **Attach inner cover:** Attach inner cover, tighten Allen screws and replace the connection cables.

9. **Close camera housing:** Close the camera housing as described in Section 2.2.8, then reconnect the power supply.



10. **Activate recording:** If you have inserted a MicroSD card that has already been MxFFS formatted, you can activate recording under **Admin Menu > Storage** on External File Server/Flash Device. Once the camera has been rebooted, it automatically activates recording.
11. **Format MicroSD card:** If a new MicroSD card is used, it must be formatted before use as described in Section 3.5.2, «Formatting the MicroSD Card».

2.7 Network and Power Connection

- Power is supplied to the camera via the camera Ethernet connection (patch or installation cable). We recommend using a MOBOTIX PoE adapter or another similar high-quality PoE product to loop-in the power supply:
 - **One camera:** with the PoE adapter (MX-NPA-PoE or MX-NPA-Box)
 - **Multiple cameras:** with PoE products conforming to IEEE 802.3af (PoE switch)
- The **maximum length** of the network cable for power supply over an Ethernet cable is **100 m**.
- Make sure that you only use switches or routers that support the **10/100 Mbps network interface** of the camera.
- We highly recommend using uninterruptible power supplies (UPS) to provide backup power.
- If you are using IEEE 802.3af or IEEE 802.3at (PoE+) Power-over-Ethernet network components to supply power to MOBOTIX cameras, make sure, if possible, that these components do not have a fan. Since the power consumption of MOBOTIX cameras is very low compared to other products, the reliability of the entire system is increased, thus extending the life of these components.

Caution

Max. power consumption of attached extension modules: The power consumption of all attached **MxBus modules** must **not exceed 3W**. When attaching modules to the MxBus connector **and** the USB socket, the **power consumption of all attached modules must not exceed 4W, if the camera is powered by PoE class 3**. If **PoE class 2** is used, **the camera cannot power any peripheral devices!**

For information on changing the PoE class, see Section 2.7.5, «Variable PoE».

Connection of additional devices with more than 1 W (via MxBus/USB):
Max. ambient temperature +50 °C/+122 °F

2.7.1 Network Cabling for M16 with Patch Cables

Using a patch cable and an MX-Patch-Box or MX-NPA-Box offers the following advantages:

- Quick installation/deinstallation
- No shortening of the cable in the event of multiple installation/removal
- Hose-proof/dust-proof connection in accordance with IP66

Connecting the Patch Cable to an MX-Overvoltage-Protection-Box, MX-NPA-Box or Standard Network Port

First remove the blue bayonet catch and the blue sealing plug in the right-hand connector on the box to establish the network connection to an MX-Overvoltage-Protection-Box or MX-NPA-Box. Then insert the MOBOTIX patch cable into the box and secure the cable using the bayonet catch.

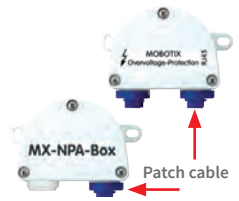

More information on installing an **MX-NPA-Box** or an **MX-Overvoltage-Protection-Box** is available at www.mobotix.com under **Product Selector > Accessories > Interface Boxes**.

Insert the MOBOTIX patch cable of the M16 into the network port for standard connections (only permitted in indoor areas).

If additional cables are required inside the housing, they must be connected as described in Section 2.2.6, «Connecting a USB Cable» and Section 2.2.7, «Connecting a Two-Wire MxBus* Cable».

2.7.2 Power Supply Using a Switch

1. Connect the factory pre-installed cable of the camera to the **camera** connector of the PoE adapter.
2. Connect the **LAN/Power** connector of the PoE adapter to the Ethernet connector of the switch/router or the Ethernet port.
3. Plug the RJ45 connector of the power supply unit into the **PC/Power** connector of the PoE adapter.

IP addresses in the diagram are shown only as an example

For the M16 you should use the blue MX-NPA-PoE-Set or the MX-NPA-Box – previous MOBOTIX network power accessories, such as the NPA-Set, Power-Box and Power-Rack (MX-NPA-Set, MX-NPR-4 and MX-NPR8/20) are not suitable for use with the M16

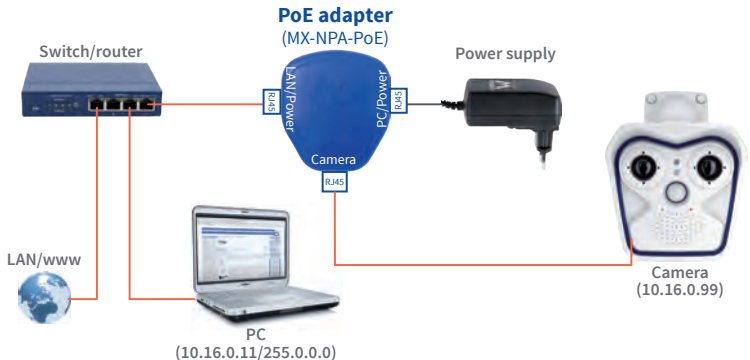

2.7.3 Power Supply When Connected Directly to a Computer

1. Connect the factory pre-installed cable of the camera to the **camera** connector of the PoE adapter.
2. Connect the **PC/Power** connector of the PoE adapter to the Ethernet port of the computer.
3. Plug the RJ45 connector of the power supply unit into the **LAN/Power** connector of the PoE adapter.

IP addresses in the diagram are shown only as an example

The PoE adapter replaces the crossover cable when directly connecting to a computer

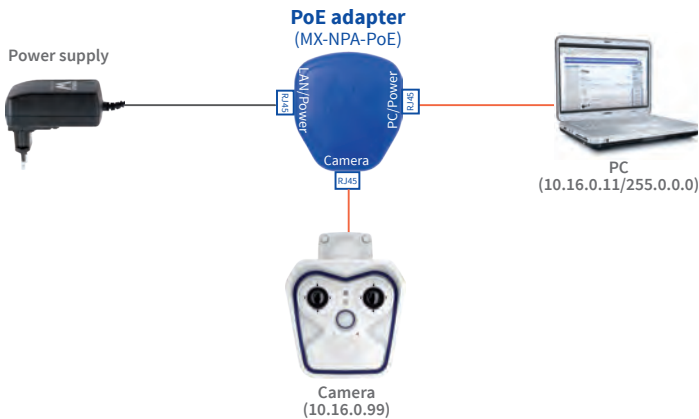

For the M16 you should use the blue MX-NPA-PoE-Set or the MX-NPA-Box – previous MOBOTIX network power accessories, such as the NPA-Set, Power-Box and Power-Rack (MX-NPA-Set, MX-NPR-4 and MX-NPR8/20) are not suitable for use with the M16!



2.7.4 Power Supply with Power-Over-Ethernet Products

Connect the factory pre-installed cable of the camera to a PoE port of the PoE switch/router. The switch/router must support the PoE standards IEEE 802.3af or IEEE 802.3at.

IP addresses in the diagram are shown only as an example



2.7.5 Variable PoE

The power consumption of the camera depends on the functions in use as well as any peripheral devices connected (see table). PoE classes 2 or 3 may be selected in the browser-based user interface in order to optimally adjust the camera to your system design (PoE switch in use, emergency power concept, etc.).

PoE Power Level Classes (IEEE 802.3af standard)		
Class	Max. power consumption	Camera operating mode and peripheral devices
2	3.84 W–6.49 W	Factory default until software version 5.0.2.x. Supported only without dual core usage and without peripheral devices.
3	6.49 W–12.95 W	Factory default since software version 5.1.0.x with dual core usage. Max. 2.5 W for MxBus peripheral devices (for example, MX-GPS-Box and MX-232-IO-Box on MxBus), max. 4 W for peripheral devices to MxBus and USB interface.

Caution

If the total power consumption of the camera and peripheral devices exceeds the power provided by the PoE switch for the specified class, the switch can disconnect the camera from the power supply. ***In this case, the camera will only be accessible again once the peripheral devices have been disconnected from the camera and the camera has been restarted.***

Variable PoE: Multiple cameras can be operated simultaneously from the same switch

The default setting is usually fine, and nothing needs to be changed. However, the PoE power class must be changed in the browser if a higher or a lower power class is required for your application:

1. Select Admin Menu > Network Setup > Ethernet Interface.
2. Click on Change under Power Supply.
3. Follow the instructions in the Power over Ethernet (PoE) dialog, which will guide you through the PoE configuration steps.
4. Next, restart the camera: Disconnect the camera from the power supply. Then reconnect it, for example, by disconnecting and then reconnecting the Ethernet cable at the PoE switch.



3 OPERATING THE CAMERA

3.1 Manual and Automatic Operation – Overview

Download the free-of-charge MxManagementCenter software at www.mobotix.com

MOBOTIX cameras do not require any extra software. Thus, you can set up and operate the MOBOTIX camera using a JavaScript-enabled browser on all common operating systems (such as Windows, Linux, Macintosh, etc.). As an alternative, you can also use the MOBOTIX application MxManagementCenter. Follow these steps to set up the camera:

1. **Connect the camera to the network.**

Power is supplied directly via the Ethernet cable (see Section 2.7, «Network and Power Connection»)

2. **Establish a connection to the camera and adjust the network settings, if required.**

By factory default, MOBOTIX cameras are booting as DHCP client with an additional fixed IP address in the 10.x.x.x range (e.g., 10.16.0.128). Local computer networks usually have IP addresses in the 172 or 192 ranges. Depending on whether a DHCP server is present on the local network (e.g., a DSL router) or if the network has been set up to use fixed IP addresses, there are several possibilities for establishing a connection to the camera and to change its network parameters:

- **Network with DHCP server**

- Using a browser:

If you know the IP address that the DHCP server assigned to the camera, simply enter that address in the browser address bar to directly connect to the camera (see Section 3.2.1, «Manually Setting Up the Network Parameters in a Browser»).

- Using MxManagementCenter:

With MxManagementCenter, you can show and integrate the camera without having to know its current IP address (see Section 3.2.3, «First Images and Network Parameter Configuration in MxMC»).

- **Network with fixed IP addresses**

In order to access the camera, it must have an IP address within the range of the local network. To set the camera's network parameters, you can use one of these methods:

- Manually using a browser:

First, you need to change the network parameters of your computer (see Section 3.2.1, «Manually Setting Up the Network Parameters in a Browser» and following ...).

- Integration into MxManagementCenter with automatic adjustment of the camera's IP address:

The camera is displayed in MxManagementCenter despite the fact that the IP address is not part of the local network. The application allows reconfiguring the network parameters accordingly (see Section 3.2.3, «First Images and Network Parameter Configuration in MxMC»).

- 3. **Configure the camera.**

Using the web-based user interface or MxManagementCenter.



Camera software
in the browser

3.2 First Images and the Most Important Settings

Once the MOBOTIX camera has been connected to the network, you need to set up the camera's network interface accordingly. This step involves setting up and checking the network parameters of the camera. If your network is already using an IP address in the 10 . x . x . x range with a 255 . 0 . 0 . 0 network mask, you do not need to change the camera's network parameters. You can access the camera directly (see Section 3.2.2). If your network or computer does not use an IP address in the 10.x.x.x range (for example, in the 192 or 172 ranges), you should follow one of the following methods for changing the camera's network parameters:

- **Manual setup** (see Section 3.2.1)
- **Automatic setup using MxManagementCenter** (see Section 3.2.3)

Note

For the following examples, we will use a camera with the factory address 10 . 16 . 0 . 99. Replace this IP address with the IP address of your camera. You will find the IP address of your camera on a small sticker on the camera. Make sure that the IP addresses used in the following examples are not already being used by other devices in the network.

Hint: Briefly pressing the key will prompt the camera to announce its current IP address on the camera speaker.

3.2.1 Manually Setting Up the Network Parameters in a Browser

You need a computer that is using a 10.x.x.x IP address in order to manually set up the network parameters of the MOBOTIX camera. The computer's network parameters usually have to be changed for this purpose.

1. Change the network parameters of your computer:

Windows 7:

1. Open **Start > Settings > Control Panel > Network Connections**. Clicking **Properties** opens the dialog box shown.
2. Double-click **Internet Protocol (TCP/IP)**. On the **General** tab, activate the **Use the following IP address** option. Enter an IP address in the 10.x.x.x range in this field (for example, 10.16.0.11).
3. Once all dialog boxes have been closed, the computer will have the IP address 10.16.0.11.

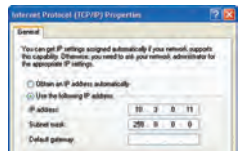
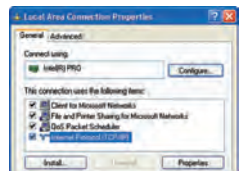

Entry in "Subnet mask" field:
255.0.0.0

First Images and the Most Important Settings

Windows 8.1/10:

1. Open **Start > Settings > Control Panel > Network Connections**. Clicking on **Properties** opens the dialog box shown.
2. Double-click on **Internet Protocol (TCP/IP)**. On the **General** tab, activate the **Use the following IP address** option. Enter an IP address in the 10.x.x.x range in this field (for example, **10.16.0.11**).
3. Once all dialog boxes have been closed, the computer will have the IP address **10.16.0.11**.

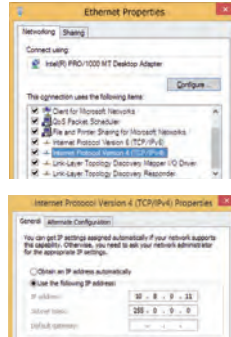

Entry in "Subnet mask" field: 255.0.0.0

Linux/Unix:

1. Open a terminal as **root** user.
2. Enter the following command: `ifconfig eth0:1 10.16.0.11`
3. The computer is now also using the IP address **10.16.0.11**

Mac OS X:

1. Open **System Properties > Network**.
2. Select **Ethernet**. In the **Configuration** field, select **Manual** and enter a 10.x.x.x IP address (for example, **10.16.0.11**).
3. Click **Apply** on the bottom right-hand side of the dialog box to assign the computer the IP address **10.16.0.11**.

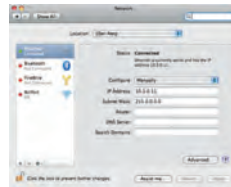

2. Set up the target network parameters of the MOBOTIX camera:

1. Open a web browser on the computer and enter the default IP address of the MOBOTIX camera in the address bar of the browser (for example, **10.16.0.99**). Clicking Enter displays the user interface of the MOBOTIX camera (see also Section 3.2.2, «First Images and the Most Important Settings in the Browser»).
2. Click on the **Admin Menu** softbutton in the user interface of the MOBOTIX camera. The Quick Installation starts automatically once the admin user has logged on.

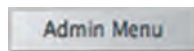

Default user data
User name: **admin**
password: **meinsm**

Note: The Quick Installation can also be executed at a later stage by opening **Admin Menu > Network Setup > Quick Installation** (see also Quick Installation in the camera's online help).

3. Enter the target network parameters of the camera on the appropriate page of the Quick Installation assistant.

Note: The network parameters can also be modified retrospectively via **Admin Menu > Network Configuration > Quick Installation**.



4. Once you have completed the Quick Installation and rebooted the camera, the new network parameters will be activated. The camera can now be connected to the target network and, if required, further configured.



3.2.2 First Images and the Most Important Settings in the Browser

Once the MOBOTIX camera has been connected to the power supply and to the network, you can access the user interface with the live camera image in the web browser. Internet Explorer, Firefox, Safari or any other graphical browser with activated JavaScript is suitable. It does not matter which operating system is used.

After entering the camera's IP address in the browser address bar, you will see the live view of the MOBOTIX camera with its user interface controls, such as softbuttons, buttons for the different camera screens, pull-down menus (Quick Controls), icons for accessing the online help and the camera status, and status information elements.

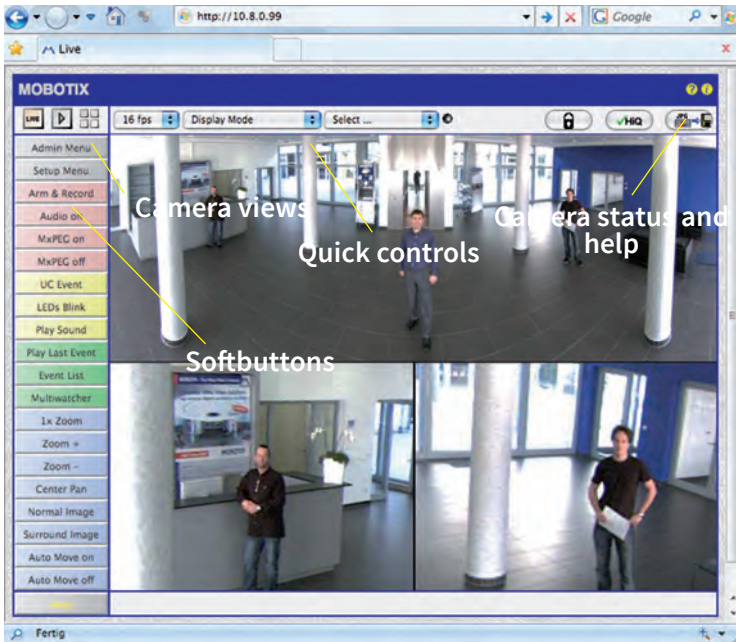

Note

Default access data for the administration menu

- User name: **admin**
- Password: **meinsm**

(Password must be changed upon first login – camera software V5.1.x and higher.)

Camera Views: Live, Player, MultiView



Live view:
<http://<camera IP>/control/userimage.html>

The MOBOTIX camera automatically displays the **live** screen when it starts up (factory default setting). You can set a different start page in **Admin Menu > Language and Start Page** (for example, the **Guest** screen) to allow a restricted access to the live image.

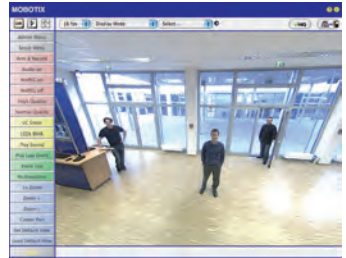

Player screen:
<http://<camera IP>/control/player>

The other available standard screens include **Player** (playback of recorded images and video sequences) and the **MultiView** screen (displays several cameras with live or recorded images).



MultiView screen:
<http://<camera IP>/control/multiview>

MultiView allows you to view several cameras via a “proxy” camera (especially useful if you want to access your cameras from outside of the network with reduced bandwidth).

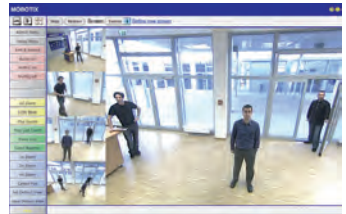

Guest screen:
<http://<camera IP>/cgi-bin/guestimage.html>

Note

Click on the  icon in the top right corner of the camera's user interface in the browser to find further information on the different camera screens.

3.2.3 First Images and Network Parameter Configuration in MxMC

Installing and Starting MxManagementCenter

Download the current version of MxManagementCenter from the MOBOTIX website (www.mobotix.com > Support > Download Center > Software Downloads in the MxManagementCenter area). Double-click the shortcut for the program or the program file.

Finding Cameras

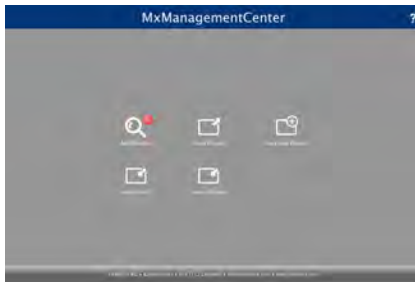

When starting MxManagementCenter for the first time, the configuration wizard opens and automatically starts searching for MOBOTIX cameras. The number of found cameras is shown next to the Add button. This number is updated automatically if the number of MOBOTIX cameras on the network has changed (i.e., by connecting new/disconnecting existing cameras).

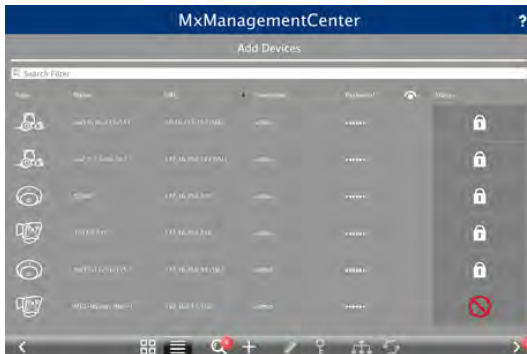

Download
MxManagementCenter
for free from
www.mobotix.com

Click on Add Devices. The cameras are displayed either in a list or as tiles. Use the List and Tile buttons to change the display mode.



MxManagementCenter automatically monitors and displays the operating status of all cameras. Cameras that are not on the same subnet as the computer are indicated by the  icon (Camera not in the same network as the computer). Likewise, the cameras that have an unknown password or for which no user name/password combination has been specified in MxManagementCenter will be displayed with the icon  (Camera is password-protected).



Reconfiguring Network Addresses of Cameras

Using Bonjour*, MxManagementCenter finds not only cameras on the same network as your computer, but also MOBOTIX cameras located in other subnets (status: ). In such a case, you would not be able to establish any connection to cameras in a different network or subnet.

This is the case, for example, if you are integrating cameras into a network without DHCP server (i.e., with fixed IP addresses) and the IP address range is different from the 10.x.x.x range supported by the cameras in addition to DHCP.

MxManagementCenter can automatically configure such a camera so that it is "integrated" into your existing network. To do so, you have to select the respective camera and then click on the  button at the bottom of the program window.

The Network Setting dialogue opens.

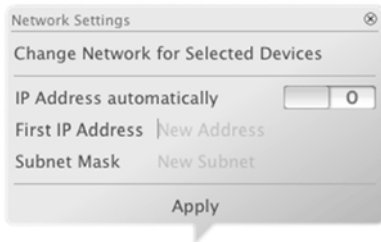

If you have assigned a fixed IP address to your computer, you will certainly prefer to assign fixed IP addresses to the cameras. To do so, enter the IP address and the subnet mask. The IP address is incremented automatically for each selected camera.

When you click on Apply, the selected cameras are automatically reconfigured and they are located in the same subnet as the computer.

First Images and the Most Important Settings

Adding Cameras

After a camera has been reconfigured, it has the status **Accessible** and can be integrated into MxManagementCenter.

Select the desired cameras (use Cmd-click to select several cameras). If the cameras are password-protected **1**, click on Edit User and Password **2** and enter the user name and password.

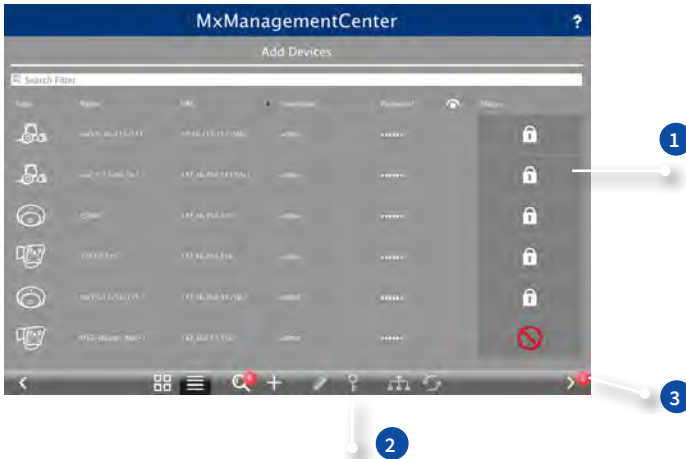

The number of selected cameras is shown on the Next button **3**. Move to the next page and click on Finish.

For more information, see the **MxManagementCenter Tutorial**, which can be downloaded as a PDF file from the MOBOTIX website: www.mobotix.com > Support > Download Center > Documentation > Brochures & Guides > Tutorials.

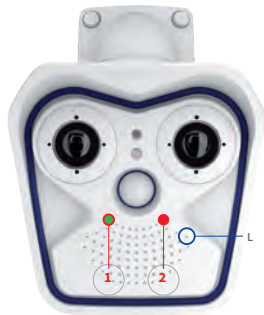

3.2.4 Start Options of the Camera

By default, the camera starts as DHCP client and automatically tries to get an IP address from a DHCP server. To start the camera in a mode different from the default mode, you can activate the boot menu of the camera.

Preparing the Camera

- Disconnect the camera's power supply.
- Make sure that you have suitable item such as a paper clip at hand, **but never use sharp or pointed objects!**
- Reconnect the power supply of the camera.

Activating the Boot Menu

The red LED lights up 5 to 10 seconds after establishing the power supply and will stay on for 10 seconds. Briefly press the key by inserting the paper clip into the hole indicated by the red circle in the figure. The camera enters the boot menu, ready for selecting one of the start options.

The LED now flashes once and repeats the flash signal after pausing for one second (the number of flashes indicates the current start option). To go to the next start option, briefly press the key again (< 1 sec). After the last start option, the camera returns to the first option (LED flashes once).

LED default settings:

- 1 Power (on), Error (flashes)
- 2 Recording (flashes)

LED flashes	Start Option	Meaning	Audio Confirmation*
1 x	—	This option is not used on this camera model.	—
2 x	Factory Defaults	Starts the camera with factory defaults (factory default IP address, users and passwords will not be reset).	Boing
3 x	Automatic IP Address	Starts the camera as DHCP client and tries to obtain an IP address from a DHCP server. If a DHCP server cannot be found or no IP address can be obtained, the camera starts with its factory default address.	Boing Boing
4 x	Recovery System	Starts the camera with the recovery system, e.g., in order to recover from a failed update of the camera software.	Alarm Sound

*Only on cameras with audio option and installed speaker.

Selecting a Start option

Press the key longer (> 2 sec). The camera confirms the selection by flashing rapidly three times. You can now remove the paper clip. After 20 sec, the camera will confirm the selection by playing a sound according to the table above.

If nothing is selected, the camera will resume its normal boot process after a certain time.

Starting the Camera with Factory (Network) Settings

If you use **start option 2** to load the factory configuration, this configuration is not automatically saved in the camera's flash memory. When the camera is next rebooted without using start option 2, the last stored configuration will be used. To permanently store the new configuration in the camera's flash memory, open **Admin Menu > Store**. Note that you can restore specific parts of the camera configuration afterwards by using "Restore" to re-apply the settings still stored in the camera.

As opposed to resetting the camera using **Admin Menu > Reset configuration to factory defaults**, the user information will **not** be reset if the camera is booted using the factory settings.

Make sure you store the default network configuration to the permanent flash memory

Starting the Camera with an Automatic IP Address (DHCP)

If you use **start option 3** to start the camera with an automatic IP address (DHCP), this is only **temporary**. The network configuration of the camera can be permanently set to DHCP (factory setting) under **Admin Menu > Ethernet Interface**.

Make sure that the network has a functioning DHCP server when starting the camera with DHCP support. If this is not the case, the camera cannot obtain a valid IP address and will use its last IP address.

You should also make sure that the cameras always obtain the same IP addresses by permanently assigning the MAC addresses of the cameras to the desired IP addresses.

In case of an error, the camera uses its last IP address

Hint: Briefly pressing the **key** will prompt the camera to announce its current IP address on the camera speaker.

3.3 Adjusting Camera, Lens Focus and Installing Filters

3.3.1 Adjusting the Camera

1. The live image from the camera is displayed on the computer monitor.
2. Loosen the screws on the VarioFlex mount using the supplied Allen wrench so that you can easily turn and tilt the camera.
3. Display the desired camera section on the computer monitor, then turn and tilt the camera until you have found the best position and sharpness. Retighten the screws of the VarioFlex mount to prevent the position of the camera from changing.
4. If required, clean the lens using a clean, lint-free cotton cloth.



Section 3.4 provides more details and information on the functionality of the OnScreen Control



Correcting the image horizon:



Rotate image to the left



Rotate image to the right

Correcting the Image Horizon (For B016 Sensor Module Only)

The M16 with hemispheric B016 sensor module allows the correction of an uneven image horizon via OnScreen Control that was possibly caused by the installation position. The image horizon is turned by up to 30 degrees clockwise or counterclockwise and can be optically restraightened by clicking the icons (see image).

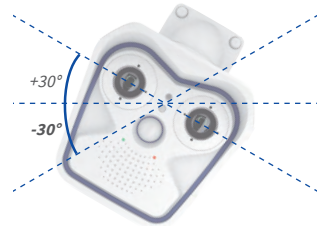

3.3.2 Adjusting Lens Focus (B119/B237 Only)

Once the camera has been installed, the B119 and B237 sensor modules should be checked for proper image sharpness and manually adjusted, if required. To do so, use the blue lens wrench and the black module wrench (both are supplied with the M16 basic module).

The focusing aid provides a visual aid when correcting the image sharpness (see The Live Screen of the MOBOTIX Camera in the camera's online help).

Procedure

1. Position the blue lens wrench on the notches of the sensor module. Rotate the wrench **to the left** until you feel a stop (max. 300°) and then a little bit further until the protective glass lens slides out of the sensor module.

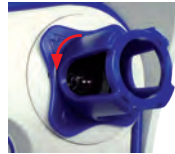

2. Adjust the image sharpness according to the camera's live image on the computer monitor. To do so, position the black module wrench (with the ring-pattern side) on the lens and carefully rotate to the right or left. **Do not turn the lens too far or with force to avoid damaging the image sensor.**



3. If required, clean the inside of the protective glass lens using a clean, lint-free cotton cloth.

4. Place the protective glass lens on the notches of the blue lens wrench.

5. Position the protective glass lens with its clips over the two receptacles on the sensor module (red arrow on the image in the margin) and firmly press onto the sensor module. Rotate the glass **to the right** using the blue lens wrench until you feel a stop.



6. If required, clean the outside of the protective glass lens using a clean, lint-free cotton cloth.

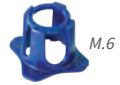

3.3.3 Inserting a Filter

MOBOTIX offers a polarization filter in its range of accessory products for all sensor modules (except the B016). The polarization filter prevents unwanted reflections from smooth surfaces. The filter can be used to provide better facial recognition of the people behind the windshield of a car, for example. Only one filter can be used per sensor module, which then replaces the standard protective glass lens.

Procedure

1. Position the blue lens wrench on the notches of the protective glass lens. Rotate the wrench **to the left** until you feel a stop (max. 300°) and then a little bit further until the protective glass lens slides out of the sensor module.



2. If required, clean the inside of the filter using a clean, lint-free cotton cloth.



3. Place the filter on the notches of the blue lens wrench.
4. Position the filter with its clips over the two receptacles on the sensor module (red arrow on the image in the margin) and firmly press onto the sensor module. Rotate the glass **to the right** using the blue lens wrench until you feel a stop.



5. Adjust the **polarization filter** according to the camera's live image on the computer monitor. Rotate the filter to the left using the blue lens wrench until you reach the desired setting (maximum 180°).
6. To readjust the polarization filter, rotate it back **to the right** until you feel a stop and repeat step 4.
7. If required, clean the outside of the filter using a clean, lint-free cotton cloth.

Note

Note that using the **polarization filter** reduces the amount of light that enters the lens by approximately 50 %.

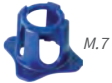

3.3.4 Replacing the Dome Against the Sealing Ring (B016 Only)

For special scenarios with hemispheric sensor modules, e.g., if light entering from the side creates reflections within the dome, you can use the sealing ring instead of the dome (order no. MX-OPT-Ring-L10-L12).

To exchange the dome against the sealing ring, use the blue lens wrench supplied with the S15D basic module.



Caution

In order to avoid burns by the hot lens, the sealing ring must not be installed if the sensor module is within the reach of persons!

Procedure

1. Insert the blue lens wrench into the notches of the dome. Rotate the wrench **to the left** until you feel a stop (max. 300°) and then a little bit further until the dome slides out of the sensor module. When doing this, make sure that the dome does not get stuck in the sensor module housing.
2. Turn the wrench over, insert the two notches into the slots of the lens' metal ring and unscrew the lens until you can remove it from the sensor module.
3. Insert the lens into the sealing ring as shown.

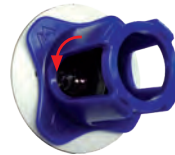

4. Fully insert the lens into the sealing by pressing firmly on two sides of the lens, until the metal rim of the lens is on the same level as the sealing.



5. Screw the lens with the sealing ring back into the sensor module using the blue lens wrench.



6. Adjust the image sharpness according to the live image on a computer monitor. Use the blue lens wrench for this purpose and turn the lens cautiously to the left and to the right. **Do not turn the lens too far or with force to avoid damaging the image sensor!**



3.4 Virtual PTZ and Full Image Recording

3.4.1 Preparing the Virtual PTZ Function

The virtual PTZ function allows you to use a mouse or joystick to continuously zoom in on images from the selected video source and “virtually” move the enlarged image section within the entire image sensor area.

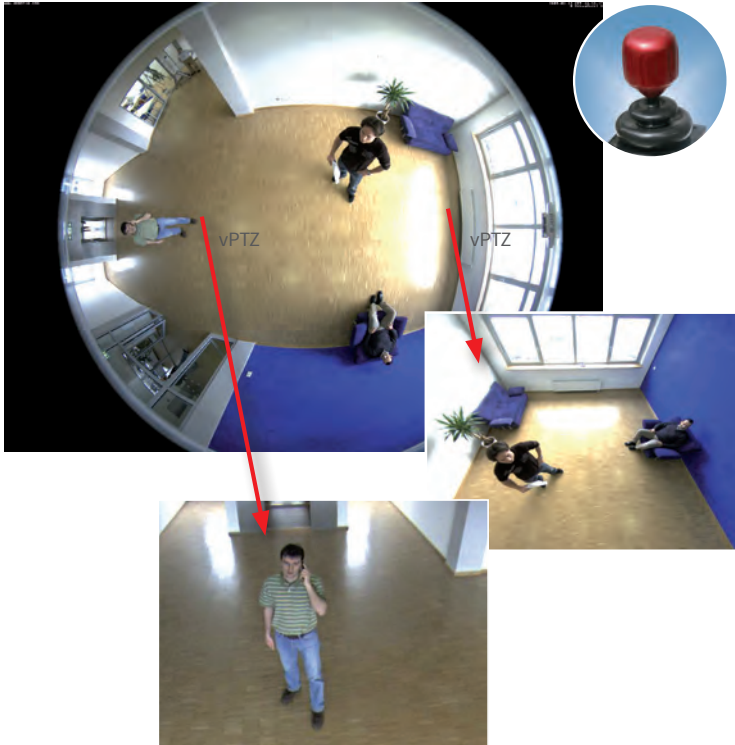

Greater ease of use through a joystick

Operation Using the Mouse and Scroll Wheel

The vPTZ function of the M16 can be controlled in the browser using the mouse. This position becomes the new image center by clicking any position on the image displayed on the monitor. The image moves accordingly and the image distortion is automatically corrected. The **scroll wheel** can be used to control the zoom function. This functionality is disabled in the default settings of the camera and must therefore first be activated. To do so, go to **Setup Menu > vPTZ Settings**, disable **Lock Mouse Wheel Zoom**, click **Set** and then **Close** to save your settings. You can now use the scroll wheel to zoom + (scroll forwards) or zoom - (scroll backwards).

Operation Using USB Joystick

A standard USB joystick can drastically improve vPTZ operation for the user – in the browser and in MxManagementCenter. Please first install the joystick on the computer according to the manufacturer’s instructions.

In order to use a USB joystick in the browser, make sure that you have a PC with a Windows operating system and the latest version of Internet Explorer and that the **“ActiveX” mode in the camera software (browser) is activated:**

- Select **Browser** in the Quick Control.
- In the dropdown to the right of to **Browser**, select the ActiveX option. The USB joystick can then be used until the browser is closed.
- If you want to store this setting permanently, open **Admin Menu > Language and Start Page** and in **Page Options > Operating Mode**, select **ActiveX**.
- If you want to store the current settings permanently, click on **Set** and **Close** at the bottom of the dialog and approve storing the settings when prompted.
- The joystick can now be used.

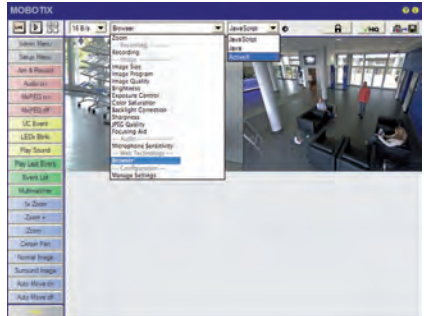

Notes

You will find more information and details on vPTZ in the Camera Online Help or in the MxManagementCenter Tutorial on www.mobotix.com, **Support > Download Center > Documentation > Brochures & Guides > Tutorials**.

The latest versions of all the manuals are available for download from the MOBOTIX website www.mobotix.com under **Support > Download Center > Documentation > Manuals**.

3.4.2 Full Image Recording

It is possible to record a **full image**, regardless of the live image stream that is being displayed. This ensures that the recording always contains the full image of the lens used, even though the operator may have used the vPTZ features to zoom into the image in order to examine a specific detail.

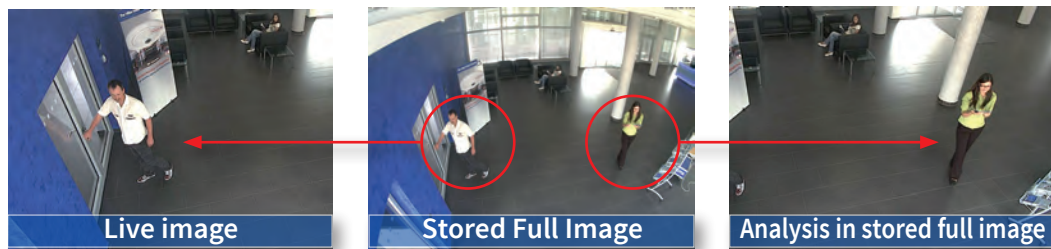

This means that you can use the vPTZ features in VGA image size to pan, tilt and zoom in the live image while the camera is, for example, recording full images at 1 fps in MEGA or 6MP image size.

In **MxManagementCenter**, the recorded full images may be prepared for the user with the vPTZ functions (for example, panning and zooming in on an image detail such as a doorway).

If **full image recording is not activated**, only the last displayed live image will be saved (save what is seen). The **main benefit** of live image storage is to ensure that the full power of the camera processor is used for live image correction and maximum frame rates. The **main advantage of full image recording** lies in the special functionality of the M16, in that it can always maintain availability of a maximum size (full) image for later investigation, despite vPTZ actions carried out on the live image. The mechanical limitations of motor-driven PTZ cameras mean that they simply **cannot** provide this unique advantage to the user!

Stored full image:
Original camera image
without distortion or
image correction

Notes

Post-event search in the full image: If you are using full image recording on M16 cameras, you should use at least MEGA image size when storing. This will facilitate later searches in **MxManagementCenter**. The advanced distortion correction features require this function to deliver satisfactory image quality.

Full image recording on: Due to the increased processing time, full image recording reduces the data rate of the live image stream, which may drop by around 10 to 30 percent. We therefore recommend reducing the frame rate for storage as much as possible to affect the live image stream as little as possible.

Full image recording off: The event that triggered a video motion (VideoMotion, VM) window may not be in the recorded sequences because the window was not displayed at the time.

Activate/Deactivate Full Image Recording in the Browser

To configure this feature, open the Setup Menu > Event Control > Recording dialog box and activate or deactivate the Full Image Recording option.

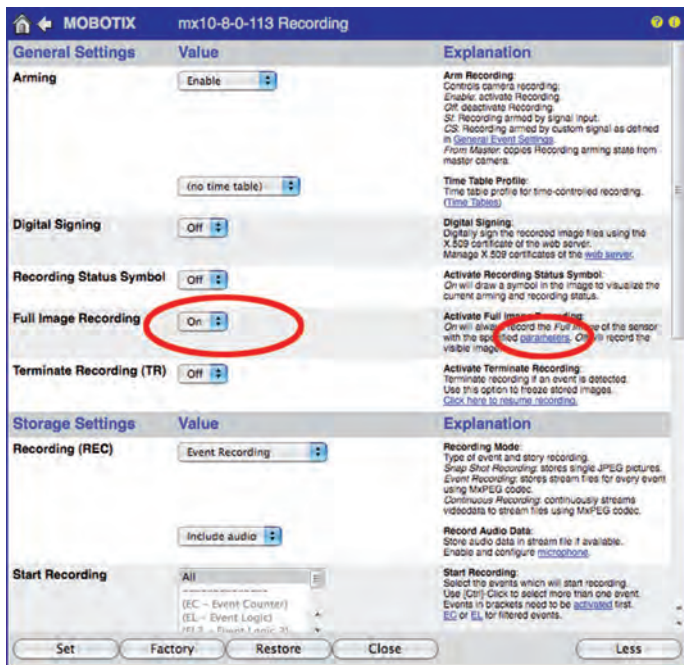

3.4.3 Special M16 Configuration in the Browser

M16 and Different Sensor Modules

A range of combination options are provided that change the available display modes and configuration possibilities by using the MOBOTIX M16 with different sensor modules.

Because of this, a M16 automatically detects which sensor modules are installed and proceeds as follows:

- When the camera is started for the first time, it detects the connected sensor modules and captures their data (focal length, day or night version).
- If only one sensor module is connected, the camera acts as a mono camera (meaning that there is no automatic day/night switching, etc.).
- If there is no change within the first 12 hours of operation, the camera writes the details of these sensor modules to the camera configuration.
- With every restart, the camera checks if the stored sensor modules are present. If the sensor configuration has changed in the meantime (e.g., because a sensor module has been exchanged), **the camera shows a corresponding message in the live image**. To store the changed sensor configuration in the camera, proceed as described at the end of Section 3.4.3, «Special M16 Configuration in the Browser».

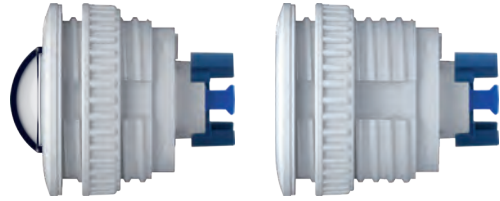

Sensor module B016*

Sensor modules B036*, B041*, B061*, B079*, B119*, B237*



Sensor module B500*

Configuration of the M16 Basic Parameters for Hemispheric Sensor Modules

Thanks to its hemispherical lens, the MOBOTIX M16 provides certain special configuration options for the image settings. Depending on where the camera is installed (ceiling, wall or floor) and on the live image display preferred by the user, certain important basic settings and, if necessary, their adjustment must be configured when a M16 is first installed.



Complete the steps described below in the browser window:

1. **Log the camera on and boot it** as described in Section 3.2, «First Images and the Most Important Settings». Depending on the number of sensor modules used, proceed as follows:
 - **One sensor module:** Proceed with step 2.
 - **Two sensor modules:** In this case, the remaining steps need to be executed separately for each sensor module. Specify each sensor module's installation position separately in the **Installation (right)** and **Installation (left)** Quick Control fields for the right and left sensor module (i.e., camera image), respectively. If you need to use the OnScreen Control (see next section), click into the corresponding sub image when viewing a dual image or show the image of only one sensor module.
2. **Select installation position wall/ceiling/floor:** Click Installation in the Quick Control panel and then select Wall, Ceiling or Floor according to the installation position of the camera. Ceiling always means that the orientation of the camera or sensor module is from **top to bottom** and for Floor, the camera or sensor module's orientation is from **bottom to top**.



Left and right camera images from two sensor modules (M16)

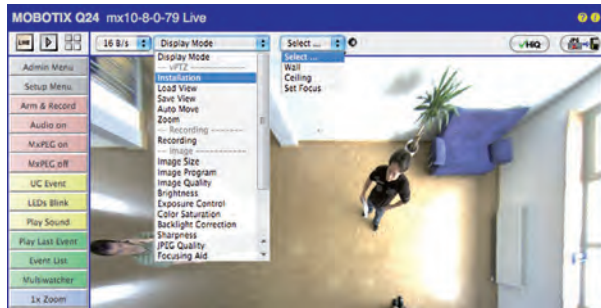

As a result, you will get a **perspective-corrected panorama view** for each image sensor matching the specified installation position. Panorama view is configured as the factory setting and it can be changed as described below.

3. Switch to the **Display Mode Quick Control**.
4. Set the mode that you want to be the standard view. For demonstration purposes, the descriptions below describe the typical display mode for the wall mount and the ceiling mount, **Panorama** and **Surround** respectively. Every other display mode can be operated in the same way.

Wall-Mounted: Setting and Correcting the Standard View “Panorama”



Camera live image with panorama correction

1. In the **Display Mode Quick Control**, select the **Panorama** option. Examine the image that is now displayed. If the section meets your expectations, no further adjustment is necessary, and panorama configuration is complete. To change the image section to meet your specific expectations, continue with step 2.



Camera live image without MOBOTIX panorama correction with Quick Controls visible

Note

The currently visible image section may differ from the desired image section due to the installation position or any accessories in use, for example. However, it is not necessary to physically move the camera, as in this case the browser alone can be used to adjust the visible panorama image by zooming, panning and tilting. Tilted vertical lines may also be optically straightened to the image edges using the panorama correction function. These tilted lines are primarily caused if the camera or sensor module is tilted (for example, due to mounting with 15° wedges) or if the image tilt is modified.

- Click the **lock icon**. Clicking the lock once opens it (lock clasp is raised). The lock prevents execution of later vPTZ actions, which could also unintentionally modify the view you configure. This applies to all overview display modes, that is, also to Panorama/Focus, Double Panorama and Surround.



Lock open

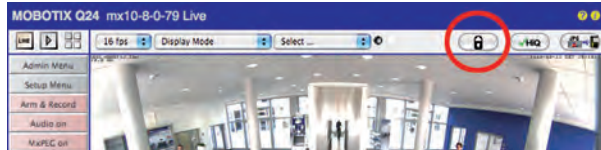

- A new icon for processing the panorama image appears in the top left corner of the camera image. Enlarge the image by clicking the icon once (OnScreen Control appears).



Click the icon

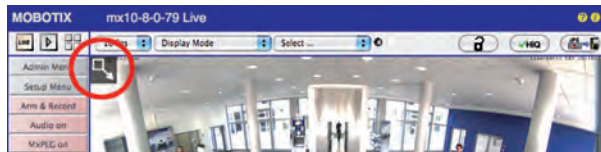

- Using the **OnScreen Control** visible in the live camera image, you can now change the displayed live camera image as desired (panning, tilting, zooming, rotating and panorama correction). See figure on the right. When doing so, the vPTZ function using the mouse or joystick is deactivated. In case of a M16 with two sensor modules, click the corresponding camera image (right/left) to edit it (highlighted with a yellow frame).

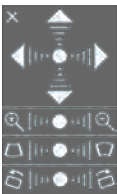

Camera live image with panorama correction with OnScreen Control visible

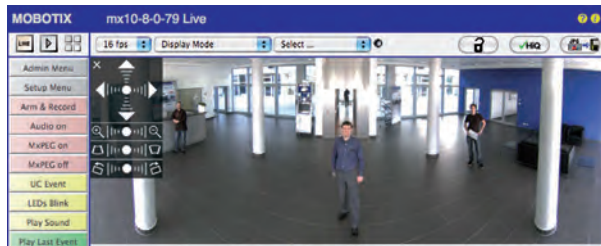

- After you have modified the desired setting, close the control panel (“x” in the top left hand corner).
- Click the **lock icon again** to close it (lock clasp is down). The panorama image setting is then locked until the camera is next restarted.

Caution

To permanently save the standard image setting defined for the M16, go to the **Store Complete Configuration** option in the **Manage Settings** Quick Control. The settings will then remain in effect, even after rebooting.

Virtual PTZ and Full Image Recording

Functions of the M16's OnScreen Control

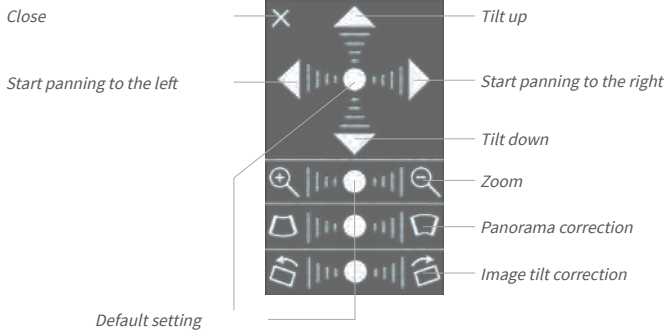

To use the OnScreen Control, click the arrows in the top area for shifting the image section. In the bottom areas, which are displayed when needed, click to the left and/or right of the center point.

The same applies to every area: **The further away that you click from an area's center point, the greater the change triggered.** To reset an area, click its center point again.

During panorama correction, clicking between the two trapezoid symbols straightens the left or right tilting lines, which are best visible at the edges of the image section.

Depending on the installation position (ceiling, wall, floor), panorama correction and image tilt correction may not be available



Bring columns together at the top (necessary to correct the example on the left)



Bring columns together at the bottom

Ceiling-Mounted: Set North (User-Defined North Direction)

Once a sensor module (M16) or entire camera (M16) is installed on a ceiling, you need to specify its North direction. This is not the “true” direction of North but rather the main line of sight or the focus of the camera or sensor module. It serves as a reference for the North direction in the **Surround** and **Double Panorama** display modes (the **Ceiling** option was already selected in the **Installation Type Quick Control**).

1. In the case of a double image, click the corresponding sensor module (camera image) and select the **Normal** option from the **Display Mode Quick Control**.



For vPTZ use and the configuration of a USB joystick, see Section 3.4.1

2. Rotate the live image in the desired direction using the mouse or a joystick connected to the computer.



Virtual PTZ and Full Image Recording

- In the Installation Quick Control, select the Set North option.

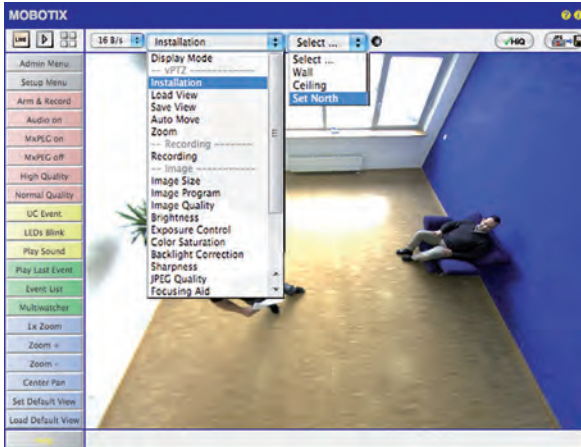

- Store the desired North direction permanently by first activating the checkbox and then clicking on Yes.

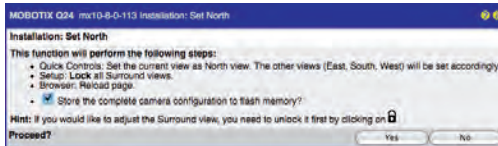

- You have now set the North direction for the Surround and Double Panorama display modes. In the next step, you can set these views as the standard view for the camera live image.



Caution: No OnScreen Control is available in "Double Panorama" mode

- In the **Display Mode Quick Control**, select the option **Surround or Double Panorama**. You can fine-tune the views using the vPTZ via mouse or joystick and, as described above, by unlocking and locking the standard view using the lock icon (open lock, correct display and close lock again).



Note

For each of the **subviews** (*North, East, etc.*; see below), the **OnScreen Control** on the side can be used to adapt it (open lock, click subview, adapt view, click next subview, adapt view and close lock again).

Camera Images and Subviews of Camera Images

The M16's ability to operate multiple sensor modules means that in double image display, the live image's **camera images** (left, right) can be used for differing display modes. Depending on the display mode selected for each camera image, this may be divided into **subviews**:

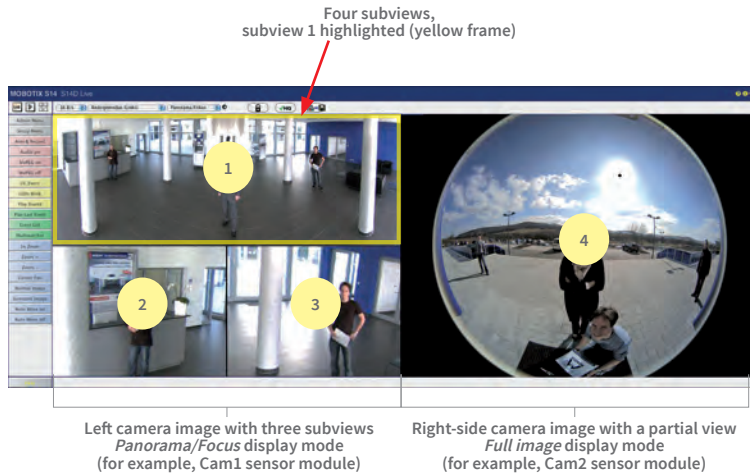

When you click inside one of the subviews, this area is highlighted with a yellow frame. All of the PTZ actions triggered by the mouse, joystick or OnScreen Control now only apply to the highlighted subview.

Sensor Configuration (Only with Two Sensor Modules)

Sensor configuration specifies which sensor module is connected to which of the camera's connections (**Cam1** or **Cam2**), and in which camera image (left/right) the sensor module is to appear for the dual image display. Open the corresponding dialog box here: **Admin Menu > Sensor Configuration**.

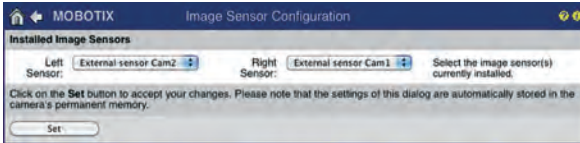

You should also open the **Sensor Configuration** dialog box in the following cases:

- **Swapping the displayed camera images:** You wish to display the left camera image on the right (and vice versa) without having to replug the sensor module cables on the camera itself.
- **Replacement of sensor modules:** In this case, the M16 detects after startup that the sensor modules have been replaced and indicates this through an alert superimposed on the live image as well as through a system message (**Admin Menu > System Messages**; see Section 3.4.3, «Special M16 Configuration in the Browser»).
- Adding/switching on sensor modules: This is where you can re-enable deactivated modules.
- **Removing/switching off sensor modules:** This is where you can deactivate any connected modules if needed.



More robust than hard drives: Flash drives for recordings

3.5 MicroSD Card Recording

3.5.1 Introduction

Flash-based storage devices (MicroSD cards, USB sticks and solid-state drives) do not contain any moving parts as compared to the commonly used hard drives. Flash-based storage devices are compact and highly resistant to moisture and vibrations. They feature low energy consumption and they do not lose any data in the event of a power failure, meaning that they are ideal for use with MOBOTIX cameras.



Number of Write/Delete Cycles Per Flash Storage Cell

The number of write/delete cycles of every storage cell of a flash device is limited. The controller of the flash device automatically detects individual flash cells that are no longer functioning. The contents of the faulty cell will then be rebuilt using a checksum and will be moved to a properly working spare cell. The faulty storage cell will be marked as “bad” and will no longer be used. No data is lost in this process.

In addition, MOBOTIX cameras constantly monitor activated flash storage devices. MOBOTIX has developed a technology to test the wear of the flash device by logging the number of write/delete cycles (patent pending). The flash memory wear is automatically displayed in the status bar in the live camera image but it can also be viewed at any time in the **Admin Menu > Camera Status** dialog box.

Conservative Memory Usage Thanks to MOBOTIX MxFFS File System

MxFFS formatting of the MicroSD card means that the MOBOTIX camera software will use the flash device as evenly as possible, thus allowing for the maximum possible number of write/delete cycles. This also means that all storage cells of the flash device will be written and deleted with the same frequency, if possible. MOBOTIX technology increases the life of the flash device considerably and also improves the security and the reliability of the storage process.

Storage Requirements and Life Expectancy of MicroSD Cards

The life expectancy of a MicroSD card increases proportionally to the storage capacity, since the camera software will execute fewer write/delete cycles on each storage cell. The first deletion will begin once the SD card has been filled to capacity (first full cycle).

MicroSD Card Recording

All specifications are based on calculated averages

32 GB MicroSD Card: Storage Requirements					
	6 fps CIF	6 fps VGA		1 fps MEGA	1 fps QXGA
	M-JPEG	M-JPEG	MxPEG	M-JPEG	M-JPEG
File size single image	15 kB	45 kB	–	120 kB	240 kB
Storage required per second	90 kB	270 kB	75 kB	120 kB	240 kB
Storage required per 24 hours	7.8 GB	23.5 GB	6.5 GB	10.4 GB	20.8 GB
Time for one full cycle	4 days	1.3 days	4.8 days	3 days	1.5 days

4 GB MicroSD Card: Storage Requirements					
	6 fps CIF	6 fps VGA		1 fps MEGA	1 fps QXGA
	M-JPEG	M-JPEG	MxPEG	M-JPEG	M-JPEG
File size single image	15 kB	45 kB	–	120 kB	240 kB
Storage required per second	90 kB	270 kB	75 kB	120 kB	240 kB
Storage required per 24 hours	7.8 GB	23.5 GB	6.5 GB	10.4 GB	20.8 GB
Time for one full cycle	12 hours	4 hours	14.4 hours	9.2 hours	4.4 hours

Caution

The MicroSD card's service life depends on production quality and frequency of use. Set the type of recording (event-controlled or continuous recording, frame rate, image size) according to your specific requirements.

We recommend changing the pre-installed, high-quality MicroSD card once a year if you have it constantly set to continuous recording.

Monitoring the Cell Wear of Flash Storage Devices (Patent Pending)

MOBOTIX uses its own technology for this purpose and has a pending patent. You can view the flash wear in the status bar of the live image or by opening **Admin Menu > Camera Status**. In addition, the camera can also send a warning message (for example, via e-mail) as soon as a critical error is detected when data is written to the SD card (**Admin Menu > Error Notification Function**). The MicroSD card can then be replaced to ensure that any existing data is not lost.

File Server / Flash Device	
Type	SD Flash Card
File System	MxFFS
Flash Wear	1%
Transfer Buffer Usage	0% (0: 0%, max: 0%)
Lost Event Images	0
Sequences	1 (1 files)
Newest Sequence	1970-01-01 01:00:00 #0
Oldest Sequence	1970-01-01 01:00:00 #0
Current Usage	4.0 MBytes (0.4%)
Max. Size	936 MBytes

3.5.2 Formatting the MicroSD Card

Format SD card:

Admin Menu > Storage
on External File Server/
Flash Device

Before a MOBOTIX camera can store image and video sequences on a MicroSD card, it needs to be formatted as MxFFS (MicroSD cards delivered with MOBOTIX cameras are already MxFFS-formatted). The following steps are necessary to format a storage device (**Admin Menu > Storage on External File Server/Flash Device**):

1. Make sure that there is a MicroSD card in the card slot of the MOBOTIX camera.
2. Click **Format** in the **SD Memory Card** line.



3. Note down the characters shown in the **Encryption password** field or enter your own password. Next, click **OK**.



Note: The **Secure deletion – Slow** option will ensure that any data on the MicroSD card is overwritten completely so that the data cannot be recovered in any way. However, keep in mind that this kind of safe formatting takes considerably more time.

4. In the next dialog box, enter the user name and the password of a user of the **admins** group and click **OK** to confirm.

The MOBOTIX camera now starts formatting the card. It takes 5 to 12 minutes to format an 8 GB MicroSD card if the **Secure deletion – Slow** option is disabled. If **Secure deletion – Slow** is enabled, this may take anywhere between 3 and 14 hours.



Once the formatting has been completed, you can activate the MicroSD card for recording (see next section).

Caution

Make sure that you always wait until the formatting process has been completed before accessing the camera again. If the **Secure deletion – Slow** option is disabled, this usually takes just a few minutes. You can only access the MicroSD card once MxFFS formatting has been completed.

Formatting with the **Secure deletion – Slow** option enabled takes several hours. You can also use suitable applications on Windows, Linux/UNIX and Mac OS X systems to repartition and safely erase the MicroSD card.

3.5.3 Activating Recording

Follow these steps to activate the recording to a MicroSD card that has already been MxFFS-formatted (**Admin Menu > Storage on External File Server/Flash Device**):

Activate recording: **Admin Menu > Storage on External File Server/Flash Device**

1. Make sure that there is a MicroSD card in the card slot of the MOBOTIX camera.
2. Make sure that the MicroSD card is formatted in MxFFS format.
3. Activate the **SD Memory Card** option.
4. Click **Set** and then **Close** to store the configuration.
5. Reboot the MOBOTIX camera (**Admin Menu > Reboot Camera**).

Once the camera has rebooted, make sure that the camera displays the **FR REC** symbol in its live image. If this is the case, the camera uses the MicroSD card as recording target. If not, you must activate the recording (see below).

Activating the Recording

If the **FR REC** symbol is not visible in the live image after rebooting, you need to activate the recording using one of the following methods:

- **In the web browser:** Automatic activation by clicking on the **Arm & Record** softbutton. Confirm this in the Easy Dialog by clicking on the **Yes** button.
- **In the web browser:** Manual activation via the Quick Control **Recording > Recording On** or in **Setup Menu > Recording**.

Encryption and Authentication

All video data stored on the MicroSD card is encrypted to ensure security at all times. The password for this is defined during the card's formatting procedure and needs to be entered for authentication whenever the recordings are accessed (see next section).

3.5.4 Accessing Data on the MicroSD Card

The following options facilitate access to the stored image and video sequences on a MicroSD card:

- **In the web browser:** Play back the recorded event images without sound directly from the MicroSD card using the Playback view of the camera software.
- **In MxManagementCenter:** Play back the recorded video sequences with audio by accessing the MicroSD card in the MOBOTIX camera via the camera or with a direct access to the MicroSD card via a card reader connected to the computer (coming soon).

Caution

When using the MicroSD card from one MOBOTIX camera in another MOBOTIX camera, you need to make sure that the time on the original camera is in sync with the new camera. We recommend using automatic time synchronization via a time server (**Admin Menu > Date and Time**).

3.5.5 Deactivating Card Recording

Follow these steps to deactivate recording to a MicroSD card (**Admin Menu > Storage on External File Server / Flash Device**):

1. Activate the **None** option.
2. Click on the **Set** button at the bottom of the dialog box and then **Close**.
3. Reboot the MOBOTIX camera (**Admin Menu > Reboot Camera**).

Once the camera has rebooted, make sure that the symbol **FR REC** is no longer visible in the bottom right-hand corner of the live image.

4. You can now safely remove the MicroSD card from the camera (see Section 2.6, «Replacing the MicroSD Card»).

Caution

A MicroSD card may only be removed from the camera after you have deactivated the recording to MicroSD card and rebooted the camera. **Failing to do so may lead to data loss!**

Removing connected flash storage devices from the camera without properly deactivating them may lead to data loss and/or destroy certain sectors of the storage device. This is limited to 4 MB of lost data per incident due to MxFFS formatting.

3.5.6 Using a MicroSD Card in a Different MOBOTIX Camera

A MicroSD card containing recorded data from a MOBOTIX camera can be inserted into any MicroSD card-enabled MOBOTIX camera. Once MicroSD card recording has been activated (requires a reboot), the “new” MOBOTIX camera automatically synchronizes with the card and resumes recording. No data is lost in this process. Make sure that you deactivate MicroSD card recording before removing the card from a MOBOTIX camera and then reboot the camera.

If the MicroSD card’s contents are encrypted, you need to enter the same password in the “new” camera in the **Admin Menu > Storage on External File Server / Flash Device** dialog box. Otherwise, the camera cannot access the MicroSD card.

3.5.7 Limitations on Warranty When Using Flash Storage Media

MOBOTIX will not assume any responsibility for flash storage devices (for example, MicroSD cards or connected USB storage devices) delivered with or integrated into MOBOTIX cameras. The same applies to damage to flash storage devices or damage resulting from the use of devices that are not supplied by MOBOTIX.

3.6 Configuration in the Browser

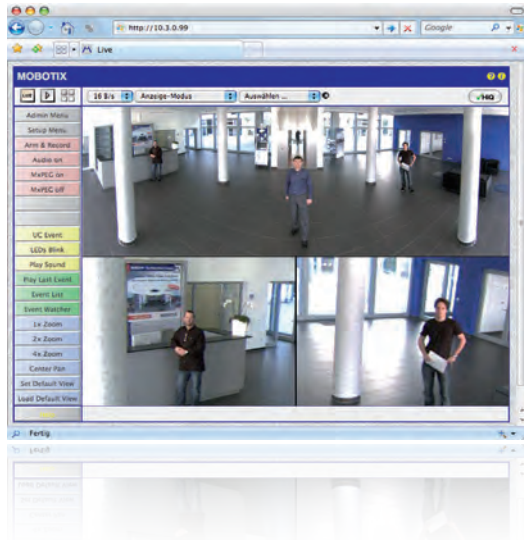

3.6.1 Overview

A MOBOTIX camera can be completely configured using a JavaScript-enabled browser on all common operating systems (such as Windows, Linux, Macintosh, etc.). The camera provides a HTML-based user interface for this purpose. The camera executes the changes you make to the camera configuration via HTTP commands using programs and scripts of the embedded software. The settings are stored in the camera's flash memory.

This section contains an overview of the general browser settings of the MOBOTIX camera, as well as further configuration options. Detailed information on the software functions is provided in the camera's online help.

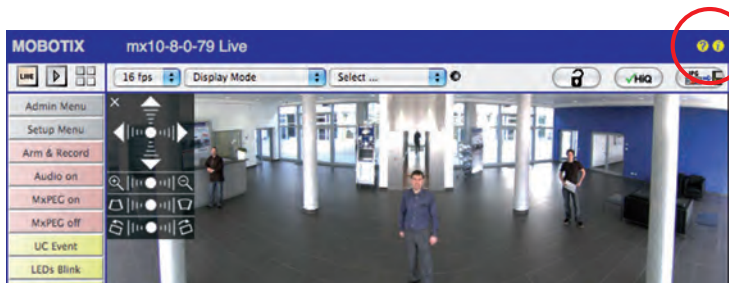

Basic Settings

- **Administering the camera:** You can modify the camera configuration in the Admin Menu or the Setup Menu.
 - **Admin Menu:** This menu contains the basic configuration dialog boxes of the camera (for example, passwords, interfaces, software updates).
 - **Setup Menu:** This menu contains the dialog boxes for configuring the image, event and recording parameters. Some of these settings can be changed using the corresponding Quick Controls in the live view.
- **Resetting changes:** If you would like to reset some larger changes in one dialog box without resetting the complete configuration, you can use the **Default** button at the bottom of the dialog box to reset only this dialog box's settings to the factory settings. If you would like to reset all image settings, you can do so using the **Manage Settings > Restore Image Settings** Quick Control in the live image of the camera.
- **Storing changes permanently:** Once you have finished configuring the camera, you should always store the settings in the camera's permanent memory. You can do so in each dialog box (clicking on the **Set** button at the bottom of each dialog box will temporarily implement the change; when you click **Close**, you will be asked to store the complete configuration in the camera's permanent memory) or in the Admin Menu (**Admin Menu > Store current configuration into flash memory**). The **Configuration** section of the Admin Menu provides more functions for storing, copying and managing camera settings. For more information on this topic, refer to the online help for the specific dialog boxes.
- **Time tasks and time synchronization:** Apart from a multitude of possibilities for controlling the camera using time (time tables, holiday and vacation, scheduled tasks, etc.), the camera can also synchronize its internal clock. This allows you to manually synchronize the camera with a computer or automatically using a time server or another MOBOTIX camera. The camera can use either NTP servers or Time Protocol servers. For more information on this topic, refer to the online help for the specific dialog boxes.
- **The "More" and "Less" buttons:** When opening some of the camera dialog boxes, the camera only shows the most important parameters. These dialog boxes have a **More** button in the bottom right-hand corner. Click it to display additional options. If all options are displayed, click on the **Less** button to hide the additional options.

User name: **admin**
password: **meinsm**

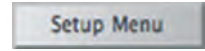
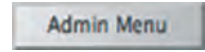

Make sure to permanently store changed parameters

Automatic time synchronization using a time server

More: Display advanced features

Less: Hide advanced features

3.6.2 General Browser Settings

- **Run the Quick Installation:** After booting the MOBOTIX camera for the first time, accessing the administration menu (the **Admin Menu** button) will automatically start the Quick Installation. The Quick Installation assistant helps you in setting the most important parameters of the camera. For security reasons, you should set your own administrator password and disable public access to the camera.
- **Disable public access:** Guest users are only allowed to access the Guest screen of the camera without entering a password. If this is not required, you should deactivate public access (**Admin Menu > Quick Installation** or **Admin Menu > Users and Passwords**).
- **Add users and assign access rights:** You can add users and user groups and assign the desired rights (**Admin Menu > Users and Passwords**, **Admin Menu > Group Access Control Lists (ACL)**), similar to a computer operating system. This approach allows individual access rights to be assigned or denied to camera-specific features based on the user groups.
- **Deactivate the automatic reboot:** In its factory state, every MOBOTIX camera will automatically reboot every morning at 3:36 a.m. All images in the camera's storage buffer will be deleted during this reboot. Images stored on external file servers, internal flash storage, or SD cards will NOT be affected by this reboot. Make sure that you deactivate the automatic reboot if this is not desired (**Admin Menu > Time Tasks**).
- **Optimize the image settings:** The factory image settings of MOBOTIX cameras deliver excellent images for most application scenarios and should not be changed. If you do wish to make changes, your changes should be minor and gradual. You should, however, set an image program according to the application scenario of the camera. Image programs provide a quick and simple method for adjusting the camera to the application scenario as they perform several configuration steps at once (**Image Programs Quick Control**).
- **Set the image size of the live image:** By factory default, all MOBOTIX cameras are delivered with an image size of 1280x960 pixels (MEGA). You can select the desired image size using the **Image Size Quick Control**.
- **Adjust the exposure:** The automatic exposure control of the MOBOTIX camera uses individually configurable windows to determine the best image exposure. Open the **Exposure Control Quick Control** and select a predefined set of exposure windows. If required, you can also define custom exposure windows (**Setup Menu > Exposure Settings**).
- **Activate event control and recording:** By factory default, the MOBOTIX camera's event control is disabled. Click on the **Arm & Record** button to activate event control. This will activate motion detection and recording. Cameras with integrated flash memory (SD card) will use the flash memory by default to store the image and video data (recording target). If desired, you can set additional events and adjust the settings of the recording and storage parameters (**Setup Menu > Event Settings**, **Setup Menu > Recording** and **Admin Menu > Recording to External File Server/Flash Device**).
- **Set up actions/messaging:** Upon detecting an event, the MOBOTIX camera can trigger alarms. These alarms can be adjusted to your needs and you can assign them to one or more events: playing back an alarm sound on the camera speaker, showing the visual

Configuration in the Browser

alarm in the camera live image, sending an e-mail or IP Notify with the alarm image, placing a phone call, uploading an alarm image to an FTP server, switching a signal output line of the camera (for example, for switching on the lights/opening a door).

For the settings, see **Setup Menu > Action Group Overview**. The actions to be performed are defined and used in these action groups in the form of “action profiles.” The different action profiles can also be defined in the following areas: Admin Menu in the Hardware Configuration (profiles for signal output), Transfer Profiles (FTP, e-mail, IP Notify) and Sound and VoIP Telephony (sound profiles, VoIP profiles). For more information, refer to the online help for the **Action Group Overview** dialog box.

- **Activate shock detector:** The M16 is also equipped with a shock detector as standard. If, for example, the camera’s housing receives a blow, it automatically registers it and sends a notification via an IP Notify or telephone call. A general advantage is that MOBOTIX cameras are extremely tough, not least because of the absence of mechanical moving parts. This typically allows them to stay fully operational, in particular, when they are subject to strong vibrations. Open the **Setup Menu > Event Control > Environment Events > Edit** dialog box if you would like to activate the shock detector (and any other sensors).

3.6.3 Configuring the M16-Thermal(-TR) in the Browser

Modifying the Display Options of the Thermal Image Sensor

By factory default, the color palette for displaying the thermal image sensor has been set to *Grayscale* and the palette is shown at the bottom of the image. In order to change the display of the thermal sensor, open the **Setup Menu > Thermal Sensor Settings** dialog in the browser, select a different palette in the **Color Palette** dropdown and click on **Set**. Use the **Show Color Palette** option to control whether or not the palette is shown at the bottom of the image. See the **Thermal Sensor Settings** help page for further information on the available options.



Events Used by Thermal Image Sensors (Non-TR)

Only the **Video Motion** and **MxActivitySensor** events are available for the thermal image sensor. These events can be configured in the **Setup Menu > Event Overview** dialog in the **Image Analysis Events** and **Environment Events** section. Starting with software release **V4.3.4.66**, this includes the ability to measure temperatures using the **Thermal Spotmeter** in the image center (four pixels) and trigger events if the temperature exceeds or drops below the specified value. By design it is not possible to recognize illumination events on the thermal sensor. For the same reason, there aren’t any exposure settings for this type of image sensor.

Extended Features for Cameras with Thermal Radiometry (-TR)

Thermal sensors with **TR technology** (*TR = Thermal Radiometry*) can measure temperature values in the entire image area and can trigger events. For this purpose, the environment events now include the **Thermal Radiometry** event type, which can be used to trigger alarms if specific temperature changes in the image are detected.

Using this event type, you can create up to 20 event profiles, each defining a measurement window within the image area. For every measurement window, you can set a minimum range and a trigger value and you can decide if the event should trigger if the temperature exceeds or drops below the specified value. The minimum range sets the number of pixels in the measurement window, which need to have a higher or lower temperature than the trigger value in order to trigger an event. To configure the new event type, open the **Setup Menu > Event Control > Event Overview** dialog in the **Environment Events** section.

Notes

- You can only use events of the type Thermal Radiometry if the sensor is running in *linear mode*. To use this mode, open **Setup Menu > Image Settings > Thermal Sensor Settings** and activate the **Linear Mode** option. Note that this has already been set for sensors with TR technology as factory default.
- If you want to use MxActivitySensor on sensors with TR technology, it is recommended to set the value range of the measured temperatures in the **Setup Menu > Image Settings > Thermal Sensor Settings** dialog to *Small (high sensitivity)*.

Important Notes on Temperature Measurement

The temperatures of objects in the image measured by thermal sensors is strongly influenced by the following factors (among others):

- Surface texture and color of the objects
- Distance between objects and the sensor
- Atmosphere between objects and the sensor

Depending on the distance and the scene, different temperature values for the same object can be observed. In order to determine the proper trigger value, you can use the new variables $\$(SEN.TTR.CELSIUS)$ and $\$(SEN.TTR.FAHRENHEIT)$ (see *Using Variables* in the camera's online help).

For further information on configuring and using thermal sensors, please see the online help of the camera in the **Setup Menu** section under **Thermal Sensor Settings** and **Events based on environment measurements**.

3.7 Additional Notes

3.7.1 Operation with Only One Sensor Module

If the MOBOTIX M16 is used with **only one sensor module, the blind module needs to be installed** (item 1.4 in Section 1.4, «Delivered Parts and Dimensions»)! If this is not the case, the camera must not be used (see Section 2.2.1, «Initial Installation of the Sensor Modules (Except M16 Complete Cameras)»).



Blind module

3.7.2 Password for the Admin Menu

Accessing the Admin Menu of the camera (the Admin Menu softbutton) is only possible after entering a user name and password.

- Factory default user name is **admin**.
- Factory default password is **meinsm**.

(Password must be changed upon first login – camera software V5.1.x and higher.)

The Quick Installation assistant automatically appears when the Admin Menu is accessed for the first time. It provides an easy method to adjust the basic camera settings to the current application scenario. For security reasons, we highly recommend changing the default administrator password after the camera has been properly configured.

Enter the user name and password exactly as shown above. Note that all entries are case-sensitive.

Caution

Make sure that you store information on **user names and passwords** in a secure place. If you lose the administrator password and cannot access the administration menu, the password can only be reset at the factory. This service is subject to a fee!

3.7.3 Permanently Deactivating the Microphone

Deactivating a camera's microphone may be necessary in order to protect the privacy of persons at a workplace or for other reasons. You can permanently and irreversibly deactivate the microphone in the **Admin Menu > Loudspeaker and Microphone** dialog box.

The microphone can be irreversibly deactivated!

Caution

This deactivation occurs in the camera module itself and cannot be reversed, even at the factory. Deactivating the microphone will also deactivate all functions that are making use of the microphone.

3.7.4 Using the Start Options of the Camera

- To reset the camera to factory settings and to use the factory IP address, please use **start option 2** as described in Section 3.2.4, «Start Options of the Camera».
- To start the camera as a DHCP client and to automatically obtain an IP address, please use **start option 3** as described in Section 3.2.4, «Start Options of the Camera».

Note

All defined users are deleted and the admin password is reset to the factory default when you reset the camera using **Admin Menu > Reset**. Use **start option 3** as described in Section 3.2.4, «Start Options of the Camera» if you would like to maintain the existing users.

3.7.5 Activating Event Control and Motion Detection



If the dotted rectangle in the live image is visible, the camera is armed

Text and logos can be also deactivated or individually configured

In its default configuration, the camera's event control and video motion detection features are not enabled. In order to activate event-controlled recording, open **Setup Menu > General Event Settings** and activate the Arming switch. Another method is to click on the **Arm & Record** softbutton in the browser's user interface. The camera displays the motion detection window in the live image (dotted frame in the center) and the camera automatically stores images as soon as the motion detection window detects movements.

3.7.6 Deactivating Text and Logo Options

As camera arming is deactivated in the camera's default configuration (see preceding section), the MOBOTIX camera only displays the text **www.mobotix.com**, the time stamp and the MOBOTIX logo at the top of the image. Once the camera arming has been activated, the text at the bottom of the live image (event, action, messaging and recording symbols) will also appear.

You can deactivate the status bar at the bottom of the live image and the text bar in the top left-hand corner by setting Text Display in the **Setup Menu > Text & Display Settings** dialog box to **Off**. Setting Text Display to **Date and Time** will only display the time stamp in the live image. To hide the logo in the live image, open **Admin Menu > Logo Profiles** and set **Logo Display** to **Deactivated**.

3.7.7 Deactivating the Camera Reboot

By factory default, the MOBOTIX camera automatically reboots once a week between 3 a.m. and 4 a.m. The reason for this is that in some rare cases, external influences (for example, radiation at high altitudes) can sometimes lead to camera malfunctions. The automatic reboot will refresh the camera's memory and will ensure proper operation without requiring any interaction on the part of the user. If desired, you can deactivate the automatic reboot of the camera in the **Admin Menu > Time Tasks** dialog box.

3.7.8 Browser

Current Internet browsers (Internet Explorer, Mozilla Firefox, Safari, Google Chrome, Opera, etc.) with enabled JavaScript can display the camera's live images with their standard settings.

3.7.9 Cleaning the Camera and Lens



If the lens becomes dirty during the installation process, clean the lens using a lint-free cotton cloth. Make sure that the lens is still in focus after cleaning and adjust its focus if required.

Cleaning Domes, Lenses and Filters

- Always mount and unmount the dome using the blue lens wrench (M.6) in order to protect it from being scratched and from getting dirty.
- Use the wide side of the black module wrench (M.7) for mounting/unmounting lens protection covers/filters. The slim side of the wrench is used to adjust the focal length (sharpness) of all lenses (except B016).
- You should clean the dome at regular intervals. Always use a soft, lint-free cotton cloth for this purpose.
- If the dirt is more persistent, add a mild alcohol-free detergent without abrasive particles.
- Make sure you instruct cleaning personnel on how to clean the camera.



3.7.10 Online Help and Camera Information in the Browser

For more information, see the online help of the camera's browser interface. Click on the  icon to open the camera's online help. Furthermore, detailed information on the camera and its current configuration is displayed in the **Camera Status** dialog box when you click on the  icon.

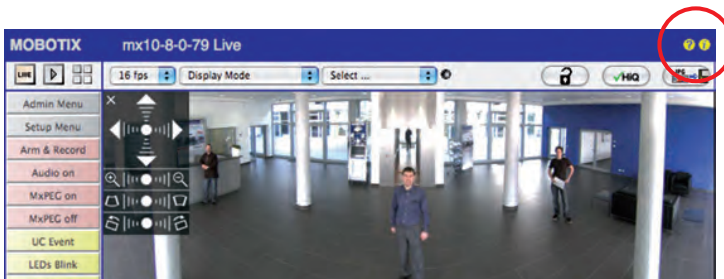

3.7.11 Declaration of Conformity

MOBOTIX products are certified according to the applicable rules and regulations of the EU and of other countries. You can find the declarations of conformity on the MOBOTIX website on www.mobotix.com under **Support > Download Center > Documentation > Certificates & Declarations of Conformity**.

3.7.12 RoHS Declaration

The products of MOBOTIX AG are in full compliance with Art. 5 of the German Electrical and Electronic Equipment Act and the E.U. Directive 2011/65/EU on the Restriction of the Use of Certain Hazardous Substances in Electrical and Electronic Equipment (RoHS) as far as they are subject to these regulations. (You can find the MOBOTIX RoHS Declaration under www.mobotix.com, **Support > Download Center > Documentation > Certificates & Declarations of Conformity.**)

3.7.13 Disposal



Electrical and electronic products contain many reusable materials. For this reason, we would ask that you dispose of MOBOTIX products at the end of their service life in accordance with all legal requirements and regulations (or deposit these products at a municipal collection center). MOBOTIX products may not be disposed of with household waste! If the product contains a battery, please dispose of the battery separately (the corresponding product manuals contain specific directions if the product contains a battery).

3.7.14 Disclaimer

Neither MOBOTIX AG nor any subsidiary of MOBOTIX AG will assume any responsibility for damage resulting from improper use of its products or failure to comply with the manuals and the applicable rules and regulations.

Our **General Terms and Conditions** apply. You can read the current version of the **General Terms and Conditions** on our website at www.mobotix.com by clicking on the **General Terms and Conditions** link at the bottom of every page.



MOBOTIX

Beyond Human Vision

Manufacturer

MOBOTIX AG
Kaiserstrasse
67722 Langmeil
Germany

Phone: +49 6302 9816-103

Fax: +49 6302 9816-190

www.mobotix.com

sales@mobotix.com

Registration Office: Kaiserslautern Local Court

Registration Number: HRB 3724

Tax Office: Worms Kirchheimbalden, Germany

Tax Code: 44/676/0700/4

VAT ID: DE202203501

You can find the latest version of this and other documents (e.g., declarations of conformity) at www.mobotix.com in the **Support > Download Center > Documentation > Manuals** section.



Technical specifications subject to change without notice!

Camera Manual

AllroundDual M16

