



More Camera For Less. Guaranteed!

The M25 series from MOBOTIX offers extremely compact, cost-effective and exceptionally powerful 6MP allround cameras with the widest range of lenses, including panorama version. Fully equipped with IP66-certified housing and long-term internal storage on a MicroSD card.

M25 Allround B036 to B500



M25 Allround B016



M25 Allround CSVario



6MP
Sensor

MxLEO



vPTZ



MxBus

USB

+50°
-30°

IP66



Innovations - Made in Germany

The German company MOBOTIX AG is known as the leading pioneer in network camera technology and its decentralized concept has made high-resolution video systems cost efficient.

MOBOTIX AG • D-67722 Langmeil • Phone: +49 6302 9816-103 • Fax: +49 6302 9816-190 • sales@mobotix.com

THE MOBOTIX INFORMATION CHANNELS



Support on the MOBOTIX Website
www.mobotix.com/other/Support



The MOBOTIX Video Tutorials
www.mobotix.com/other/Support/Tutorials



Seminars on MOBOTIX Campus
www.mobotix.com/other/Partners/Seminars



The MOBOTIX YouTube Channel
www.youtube.com/MOBOTIXAG



MOBOTIX Seminars

MOBOTIX offers inexpensive seminars that include workshops and practical exercises. For more information, visit www.mobotix.com > **Seminars**.

Copyright Information

All rights reserved. MOBOTIX, the MX logo, *MxManagementCenter* and *MxPEG* are trademarks of MOBOTIX AG registered in the European Union, the U.S.A., and other countries. *Microsoft*, *Windows* and *Windows Server* are registered trademarks of Microsoft Corporation. *Apple*, the Apple logo, *Macintosh*, *OS X*, *iOS*, *Bonjour*, the Bonjour logo, the Bonjour icon, *iPod* and *iTunes* are trademarks of Apple Inc. registered in the U.S.A. and other countries. *iPhone*, *iPad*, *iPad mini* and *iPod touch* are Apple Inc. trademarks. *Linux* is a trademark of Linus Torvalds. All other marks and names mentioned herein are trademarks or registered trademarks of the respective owners.

Copyright © 1999-2015 MOBOTIX AG, Langmeil, Germany. Information subject to change without notice!

Download the latest version of this and other manuals as PDF files from www.mobotix.com > **Support** > **Manuals**.

CONTENTS

1	Product Overview	10
1.1	M25 Allround	10
1.1.1	General Product Characteristics	10
1.2	M25 with Special Lens Hemispheric B016	20
1.2.1	Advantages and New Features	26
1.2.2	Decentralized Video System	28
1.2.3	Green IP Video	30
1.3	Technical Specifications	32
1.3.1	Lens Options	32
1.3.2	Lenses, Hardware, Image Formats	34
1.3.3	Software Features	35
1.3.4	Technical Data	36
1.4	Delivered Parts and Dimensions	38
1.4.1	M25 Camera	38
1.4.2	Dimensions for Wall Installation	42
1.4.3	Dimensions for Ceiling Installation	42
1.4.4	Dimensions of Wall Mount	43
1.4.5	Drilling Template Wall and Ceiling Mount	43
1.5	Available Accessories	44
1.5.1	Lens Cover with Glass Pane	44
1.5.2	Pole Mount	44
1.5.3	MiniUSB Cable to MiniUSB (Straight/Angled)	44
1.5.4	MiniUSB Cable to MiniUSB (Angled/Angled)	45
1.5.5	MiniUSB Cable to USB-A Socket	45
1.5.6	Ethernet Patch Cable for Bayonet Catch	45
1.5.7	NPA-PoE-Set	45
1.5.8	MX-Overvoltage-Protection-Box	46
1.5.9	MX-NPA-Box	46
1.5.10	MX-GPS-Box	46
1.5.11	MX-232-IO-Box	47
1.5.12	ExtIO Expansion Module	47
1.5.13	Mx2wire+ Media Converter	47
1.5.14	Security Screw Set with Allen Bit	48
1.5.15	Other Accessories	48
1.6	MOBOTIX Software	49
1.6.1	Integrated Camera Software (Firmware)	49
1.6.2	MxManagementCenter	50
1.6.3	MOBOTIX App	51

2	Installation	52
2.1	Preparing the Installation	52
2.1.1	Mounting Options: Wall, Ceiling, Pole	52
2.1.2	Mounting with Hemispheric Lens B016	55
2.1.3	Network Connection and Power Supply, UPS	58
2.1.4	Preparing the Camera Connections, MX-Overvoltage-Protection-Box	59
2.1.5	Wiring, Fire Prevention, Lightning and Surge Protection	60
2.2	Mounting the Camera with Wall Mount	61
2.2.1	VarioFlex Wall Mount	61
2.3	Mounting the Camera with Ceiling Mount	65
2.3.1	VarioFlex Ceiling Mount	65
2.4	Mounting the Camera with Pole Mount (Accessory)	69
2.4.1	Pole Mount (MX-MH-SecureFlex-ESWS)	70
2.5	Adjusting the Camera and Exchanging the Lens	74
2.5.1	Adjusting the Camera	74
2.5.2	Correcting the Image Horizon (for B016 Lens Only)	74
2.5.3	Exchanging the Lens	75
2.6	Replacing the MicroSD Card	76
2.6.1	Removing the MicroSD Card	76
2.6.2	Inserting the MicroSD Card	77
2.7	Network and Power Connection	78
2.7.1	Notes on Cable Lengths and Power Supply	78
2.7.2	Network Cabling For M25 With Patch Cables	78
2.7.3	Power Supply Using a Switch	79
2.7.4	Power Supply When Connected Directly to a Computer	80
2.7.5	Power Supply with Power-Over-Ethernet Products	80
2.7.6	Connecting a USB Cable	81
2.7.7	Connecting a Two-Wire MxBus Cable	82
2.7.8	Variable PoE	83
2.7.9	Camera Startup Sequence	84
3	Operating the Camera	86
3.1	Manual and Automatic Operation – Overview	86
3.2	First Images and the Most Important Settings	88
3.2.1	Manually Setting Up the Network Parameters in a Browser	88
3.2.2	First Images and the Most Important Settings in the Browser	91
3.2.3	First Images and Network Parameter Configuration in MxMC	93
3.2.4	Starting the Camera with Factory (Network) Settings	96
3.2.5	Starting the Camera with an Automatic IP Address (DHCP)	97

3.3	Virtual PTZ and Full Image Recording	98
3.3.1	Preparing the Virtual PTZ Function	98
3.3.2	Full Image Recording	100
3.3.3	Special M25 Configuration in the Browser	102
3.4	MicroSD Card Recording	109
3.4.1	Introduction	109
3.4.2	Formatting the MicroSD Card	111
3.4.3	Activating MicroSD Card Recording	112
3.4.4	Accessing Data on the MicroSD Card	113
3.4.5	Deactivating Card Recording	113
3.4.6	Using a MicroSD Card in a Different MOBOTIX Camera	113
3.4.7	Limitations on Warranty When Using Flash Storage Media	114
3.5	Configuration in the Browser	115
3.5.1	Overview	115
3.5.2	General Browser Settings	117
3.6	Additional Notes	119
3.6.1	Protecting the Camera Against Condensation	119
3.6.2	Password for the Admin Menu	120
3.6.3	Permanently Deactivating the Microphone	121
3.6.4	Starting the Camera with the Factory IP Address	121
3.6.5	Resetting the Camera to Factory Settings	121
3.6.6	Activating Event Control and Motion Detection	121
3.6.7	Deactivating Text and Logo Options	121
3.6.8	Deactivating the Camera Reboot	122
3.6.9	Browser	122
3.6.10	Cleaning the Camera and Lens	122
3.6.11	Legal Notes	122
3.6.12	Safety Warnings	123
3.6.13	Online Help in the Browser	124
3.6.14	Declaration of Conformity	124
3.6.15	Disposal	124
3.6.16	Disclaimer	124
Manufacturer		127



Legal Notes

Legal aspects of video and sound recording: You must comply with all data protection regulations for video and sound monitoring when using MOBOTIX products. Depending on national laws and the installation location of the M25, the recording of video and sound data may be subject to special documentation or it may be prohibited. All users of MOBOTIX products are therefore required to familiarize themselves with all valid regulations and comply with these laws. MOBOTIX AG is not liable for any illegal use of its products.



Safety Warnings

Installation Instructions:

- This product must not be used in locations exposed to the dangers of explosion.
- Make sure to install this product as shown in *Chapter 2, «Installation»* of this manual.
- When installing this product, make sure that you are only using genuine MOBOTIX parts and MOBOTIX connection cables.
- Make sure that you are installing this product on a solid surface that provides for a sturdy installation of the fixing elements used.

Electrical installation: Electrical systems and equipment may only be installed, modified and maintained by a qualified electrician or under the direction and supervision of a qualified electrician in accordance with the applicable electrical guidelines. Make sure to properly set up all electrical connections.

Electrical surges: MOBOTIX cameras are protected against the effects of small electrical surges by numerous measures. These measures, however, cannot prevent the camera from being damaged when stronger electrical surges occur. Special care should be taken when installing the camera outside of buildings to ensure proper protection against **lightning**, since this also protects the building and the whole network infrastructure.

Max. power consumption of attached extension modules: The power consumption of all attached *MxBus modules* must **not exceed 2.5 W**. When attaching modules to the MxBus connector **and** the USB connector, the **power consumption of all attached modules must not exceed 3 W, if the camera is powered by PoE class 3**. If **PoE class 2** is used, **the power consumption of all attached modules must not exceed 1 W!**

Never touch the lens: Due to the high performance of the M25, the area of the image sensor **can get quite hot**, especially when the ambient temperature is also high. This does not affect the proper functioning of the camera in any way. For this reason, the product must not be installed within the reach of persons without the lens cover.

Power off before opening the camera: Make sure the power supply is disconnected before opening the camera (i.e., for installing or replacing sensor modules and SD cards).

Network security: MOBOTIX products include all of the necessary configuration options for operation in Ethernet networks in compliance with data protection laws. The operator is responsible for the data protection concept across the entire system. The basic settings required to prevent misuse can be configured in the software and are password-protected. This prevents unauthorized parties from accessing these settings.



FOREWORD

Dear MOBOTIX customer,

Congratulations on your decision to purchase a professional and modern HiRes network camera "Made in Germany"! The robust and versatile M25 is a cost-efficient and professional mono camera solution with interchangeable lenses for indoor and outdoor applications (IP66). You can select from a wide range of lenses, from Hemispheric to Super Wide-Angle to Tele lenses (now up to 320 mm) and CSVario lens. Add to that the proven advantages that are inherent to the MOBOTIX concept, such as the integrated event, alarm and telephone features and the modern long-term storage directly in the camera with all of its benefits.

The weatherproof MxBus and MiniUSB interfaces of the camera allow attaching MOBOTIX interface boxes and standard devices, such as 3G/UMTS modems, external storage devices, etc. The integrated SD card flash storage is easily exchanged for larger storage requirements, providing for secure long-term storage.

The introduction of the newest image sensor technology with increased light sensitivity in combination with the new HD Premium lenses (f/1.8) provides brilliant images with image sizes of up to 3072x2048 pixels, thus delivering color images of higher quality under lowlight conditions.

You can download the **MxManagementCenter** video management software for MOBOTIX cameras from the MOBOTIX website: www.mobotix.com > **Support** > **Software Downloads**. For the iPad, iPhone and iPod touch iOS devices, MOBOTIX offers the MOBOTIX App, a free-of-charge mobile solution that is easily found when searching for "MOBOTIX AG" in the App Store.

If you have any questions, our support and international sales staff are available at intl-support@mobotix.com from Monday to Friday, 8 am to 6 pm (German time).

We would like to thank you for your trust and wish you all the best with your new MOBOTIX camera M25 Allround!



Security-Vision-Systems



© MOBOTIX AG • Security-Vision-Systems • Made in Germany

www.mobotix.com • sales@mobotix.com



1 PRODUCT OVERVIEW

1.1 M25 Allround



1.1.1 General Product Characteristics

Model Variants



The M25 is available with different feature sets. By default, the M25 is equipped with **either a color or a Black&White image sensor (Day/Night)** and an **B041 Super Wide-Angle lens (horizontal angle of view of 90°)**. If desired, the camera can be fitted with one of **seven other lenses with horizontal angles of view of 8°, 15°, 31°, 45°, 60°, 103° and 180°** or it is available as a special version with **CS Vario lens**. Every M25 comes with a pre-installed and formatted MicroSD card and a VarioFlex mount for fast and easy installation.

Due to its extreme distortion, the M25 with the **B016 Fisheye lens** is especially challenging where the adjustment of hardware and software is concerned. For this reason, the lenses

of the B016 variant are not interchangeable. The fine-tuning of the lens at the factory is an extremely laborious and precise process and the setting should not be changed any more.

Complete HiRes Video Solutions by MOBOTIX

As opposed to conventional solutions, MOBOTIX cameras with their decentralized approach offer so much more – state-of-the-art, network-based video security technology that increases operating efficiency and yields a high degree of every-day usefulness.

Extraordinary Picture Quality

Image quality is the one key criterion of a security camera. Due to their internal video analysis and data storage capabilities, the decentralized MOBOTIX systems are independent of the available network bandwidth. As a result, the system provides for efficiently storing and managing the video streams of a virtually unlimited number of cameras with the highest resolution at a reasonable cost.

6 Megapixel Image Sensors (6MP)

MOBOTIX cameras possess high-resolution image sensors with 6 megapixel resolution and excellent light sensitivity, which translates into more details when zooming and more clear-cut advantages for every user. By using the 6MP technology in their color and black&white image sensors, MOBOTIX cameras deliver convincing image quality and details even in bad weather and under lowlight conditions. Another important plus: thanks to its internal pre-processing of the image data, the camera can generate video streams with up to 30 frames per second.

6MP Image Format: 3 Times More Detail Than Full HD

The 6MP sensor has a resolution of 3072x2048 pixels on both day and night sensors. This means that the full image information is available in the live image and in the recordings.

Low Light Conditions – No Problem

The maximum resolution of the color and black&white image sensors is 6 megapixels. The higher light sensitivity of the new color image sensors now allow using MOBOTIX color cameras around the clock even when the illumination is low.

MxLEO: Exposure Optimization and Reduced Image Noise

MxLEO – the MOBOTIX Lowlight Exposure Optimization – is an innovative technology that provides an entirely new experience in digital image optimization in all cameras running firmware 4.1.9 and higher. On the one hand, the improved light sensitivity of the MOBOTIX 6MP sensors drastically reduces exposure times. MxLEO, the exposure and image optimization program especially developed for these conditions, on the other hand, generates perceptibly better and more detailed images especially under low-light conditions below 25 Lux. Such conditions are typical at a parking lot at night that is illuminated by regular lights (approx. 10 to 25 Lux). Or in a building after hours, in which the emergency lights are burning (approx. 5 Lux). This significantly reduces motion blur that is typical of longer

exposure times with little light and thus provides much more image detail (faces, license plates, etc.) for proper identification.

Hemispheric Technology

Thanks to the fisheye technology with integrated distortion correction, MOBOTIX Hemispheric cameras with their B016 lenses provide the perfect overview. Meaningful 180-degree panorama images from wall-to-wall and from the floor to the ceiling don't leave any corners of the room unmonitored. In contrast to other systems, the correction of the distorted hemispheric image happens directly in the camera and not on the computer, thus drastically reducing the size of the image before it is transferred and stored. This approach reduces the network load and allows showing dozens of hemispheric cameras on a computer or a smartphone.

Robust and Maintenance-Free

Thanks to its low power consumption of about 4.5 Watts and the total absence of mechanically moving parts, the M25 models feature a wide operating temperature range of -30 to $+50$ °C/ -22 to $+122$ °F. Since MOBOTIX cameras neither fog up nor require heating, power can be supplied via the network cabling using standard PoE products according to **PoE standard IEEE 802.3af**. M25 models are absolutely dustproof and resistant against water jets (IP66). In combination with the supplied M25 wall and ceiling mount, you can use the camera in outdoor applications and installation over flush-mounted sockets so that the **cabling remains perfectly concealed**.



VarioFlex wall mount with concealed cabling perfectly covers flush-mounted sockets

A Master of Adaptability

The M25 models are accompanied by an extensive range of easily replaceable and **interchangeable lenses** and a robust lens protector made of scratchproof special-purpose plastic or glass. Application-optimized options for installation on walls, ceilings and poles, for supplying power, or expanding the functions of the camera are also available. Furthermore, MOBOTIX customers can take advantage of the professional video management software **MxManagementCenter** free of charge and with an unlimited user and camera license. If required, an M25 can even be upgraded to function as a powerful intercom system by adding the MOBOTIX **ExtIO module**.

High-Resolution Sees More and Costs Less

One M25 equipped with a hemispheric or standard wide angle lens is usually all that is required to monitor either an entire room or the four lanes of a gas station. The high degree of image detail not only reduces the number of required cameras, but also minimizes system costs by reducing the wiring complexity, emergency power requirements and number of recording devices required. All M25 cameras feature direct recording to



MOBOTIX ExtIO
(Function Extension)

integrated MicroSD cards or external USB drives and can therefore be used in standalone operation without creating additional network load.



Universal Application from Vacation Homes to Airports

MOBOTIX M25 cameras are suitable for use in large-scale facilities, such as airports, given their unlimited scalability and high performance. However, they are equally suitable for use in small commercial or private buildings thanks to their integrated event, storage, alarm and telephony functions. In addition, MOBOTIX recommends the M25 with **hemispheric B016 lens as a superb and inspiring webcam.**

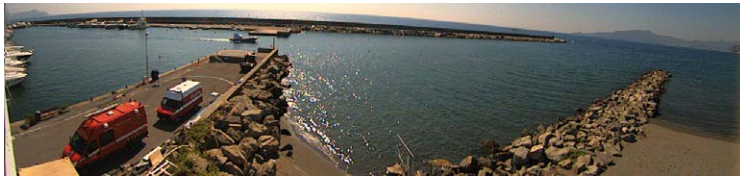

MOBOTIX original image of 180° panorama (B016 lens)

The Right Lens for Every Application

No MOBOTIX camera has ever had so many lens options! For the M25, MOBOTIX offers **seven lenses ranging from the 8° tele to the 180° Fisheye lens.**



MOBOTIX original image of 90° Super Wide-Angle

In combination with the **hemispheric B016 lens (180° horizontal angle of view)**, the M25 becomes a Hemispheric camera.



MOBOTIX original image of 180° panorama (B016 lens)

The **M25-CSVario** is an M25 model that is shipped with a CS mount and a compact **B045–100 1/2" Vario lens**. To protect the lens against the weather, this version comes with a longer lens cover and threads for an external filter. This cover will work for lenses, which have a maximum diameter of 36 mm and which are not longer than 43 mm. Because of the image sensor's size of 1/2.5", you can only use CS and C mount lenses (C mount lenses with adapter ring) for 1/2.5" sensors or larger. In comparison with MOBOTIX fixed lenses, Vario lenses are less robust and less reliable in the long run. For this reason, Vario lenses are typically used in applications where recording conditions change frequently, e.g., for surveillance of different construction sites.

MOBOTIX Standard Lenses Are Easily Exchanged

Note that you can change all **lenses** of the M25 **yourself** on site whenever necessary (except the hemispheric B016 lens). The ordered lens is factory-aligned and quality-tested in the camera, which makes on-site camera focusing unnecessary in most cases. Each M25 is available for delivery with a lens of your choosing or no lens at all.

The software of an M25 equipped with an B036 or B041 lens allows correcting the distorted image



MOBOTIX original image (B237 tele)

The image area captured by the camera varies depending on the selected lens (see Section 1.3, «Technical Specifications»). With a **Super Wide Angle lens** (e.g., B041 with 90°), for example, almost an entire room can be recorded from one corner. An **B237 Tele lens** enables an M25 with a high-resolution 6 megapixel sensor to clearly record a license plate number, for example, from a distance of approximately 75 meters.

Or even the serial number of a bill from a distance of 2 m/6 ft.

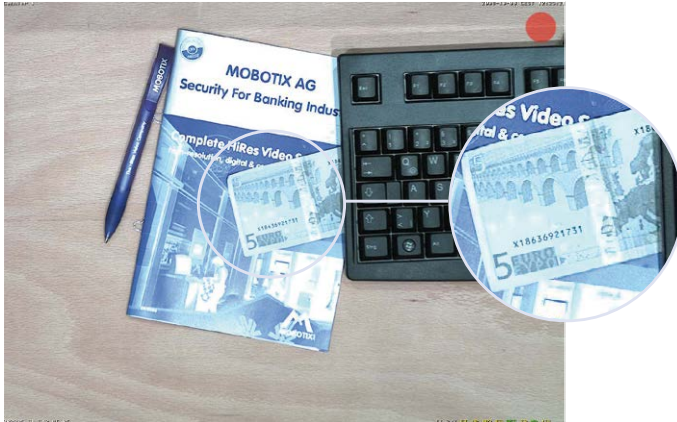

MOBOTIX original image (B237 tele)

Virtual PTZ (vPTZ) – Without Motor



The M25 can also zoom in on details. This vPTZ function (virtual Pan, Tilt, Zoom) is a standard feature in the integrated M25 camera software. The image from the hemispheric camera can be enlarged using, for example, the mouse wheel, a joystick or a software-controlled PTZ panel and you can “move” the view to any section of the image. This provides the features of a mechanical PTZ camera without the disadvantages of maintenance and wear.

Quick and easy navigation with a USB joystick

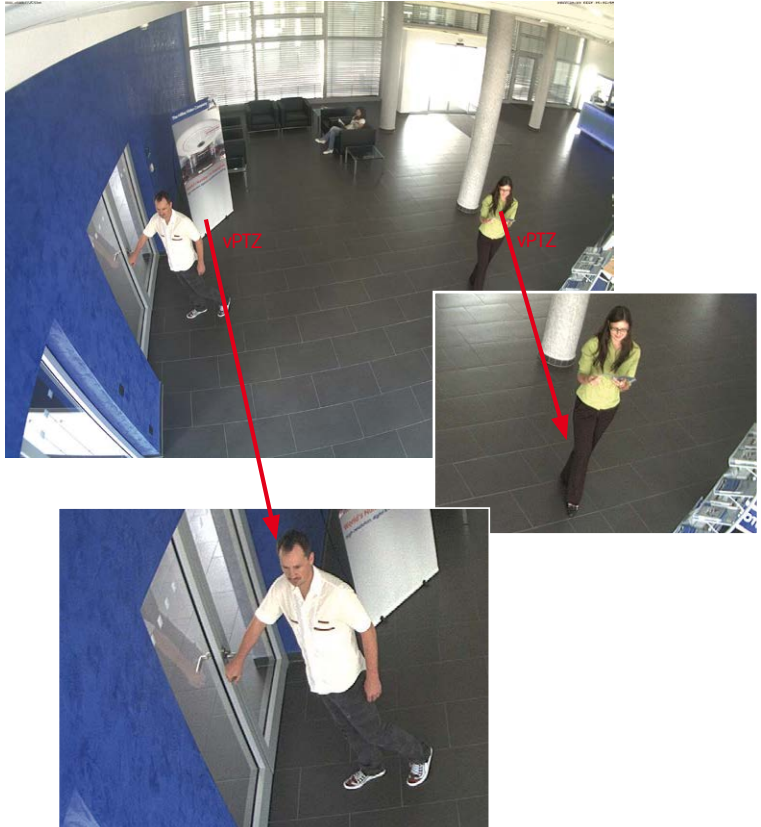

Depending on the platform used to operate the camera (**Internet browser, MxManagementCenter**), the vPTZ function may work in a different manner. When using MxManagementCenter specific software tools and an optional joystick make virtually zooming, panning and tilting much more comfortable. Even if you are using only an Internet Explorer (with activated ActiveX plug-in), you can use an optionally attached joystick.

Simultaneous Corrected Live Image and Full Image Recording

All conventional, motorized PTZ cameras only store the image that is currently viewed as the live image (**live image recording**). This has one serious disadvantage as the recording can only show what has happened in the “visible” portion of the image; the rest is lost and cannot be examined later on. For this reason, MOBOTIX has added the new **full image recording** feature to the M25. This will not store the currently viewed image that reflects the pan/tilt position and the zoom setting chosen by the user, but the full sensor image, without vPTZ settings or image correction. When examining the recorded images, the vPTZ features again come into play, as they allow zooming the visible image and using the pan/tilt features to examine every corner of the recorded full image.

Example: The persons highlighted by the red circles in the center image would not have been recorded by a regular PTZ camera; the full image recording of the M25 in this example allows determining the exact time at which these persons had entered the image area recorded by the camera. A browser (Internet Explorer with **MxPEG ActiveX plug-in**) or MxManagementCenter can be used to examine the recorded sequences.

Integrated vPTZ functions allow the complete stored full image to be analyzed at a later point in time (in MxManagementCenter)

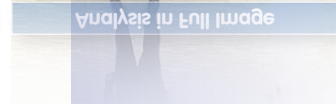
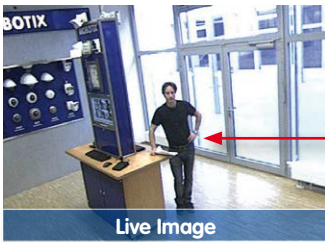

MicroSD card already
integrated in the camera.

Internal DVR

The M25 features **direct recording to the integrated MicroSD card**, which makes the camera fully independent of any external storage media, even for longer periods of time. The camera internally stores high-resolution video, without requiring an external recording device or PC and therefore without overloading the network whatsoever. Old recordings can be overwritten automatically or automatically deleted after a specified period of time. When using a 16 GB SD card, for example, the camera can store more than a quarter million event images in VGA format (640x480). For security reasons, the camera can even encrypt the stored data.



Power failures are not an issue, since the video and image sequences remain safely stored on the SD card. Access to stored video sequences is possible at any time from the camera user interface in the browser or MxManagementCenter. If you would like to archive sequences, you can export the required data to a PC or USB stick for evidence purposes, for example.

MxActivitySensor Video Motion Analysis: Secure Detection, Avoiding False Alarms

Regardless if there are large objects in the foreground or small objects in the background – MxActivitySensor will only trigger video recording and alarm messaging if something important is happening. Interference such as trees shaking in the wind, moving shadows and clouds and snow falling will no longer lead to false alarms. Since all of this is filtered automatically, all that remains is to set the direction of movement of objects that should trigger alarms.

1.2 M25 with Special Lens Hemispheric B016

Equipped with the 180° B016 lens, an entire room can be ideally monitored using only one M25, which replaces the time-consuming and expensive installation of several standard cameras. The overview image provided by a single M25, which may be personalized in a number of ways according to specific user requirements, not only reduces the number of required cameras, but also minimizes the system costs by reducing the wiring complexity, emergency power requirements and number of recording devices required.

B016 Lens: High-Resolution 180° Panorama

When several cameras are monitoring a single room, it is difficult to understand the room layout due to the different viewing directions of each individual camera. This makes it hard to comprehend the overall setting. The new panorama function of the M25 with the B016 lens delivers a widescreen, corrected image of a high-resolution 180° allround view. High image quality is achieved through the use of a six-megapixel color sensor and the new hemispheric lens of the M25.

With approximately 0.6 megapixels (1280x480 pixels), an M25 panorama image only requires a fraction of the original data volume or bandwidth of a 6MP full image (3072x2048 pixels).



Corrected image after
panorama correction

Economical bandwidth
usage due to smaller,
camera-corrected
images (no loss of
image information)

The factory default setting of an M25 with an B016 lens is a **high-resolution 180° panorama image**, in which parts of the protective cover are still visible in the upper right and left corners of the image.



Original full image



Optimizing the M25 Panorama Image

In order to hide the protective cover in the panorama image, all that is often required is the "panorama correction" function, which has already been integrated into the camera software (controlling the camera via a web browser). Tilted vertical lines (if the camera is mounted at an angle) may be optically straightened to the image edges using this function (see Section 3.5). A welcome side effect of this is that the protective cover disappears from the image.



180° panorama image after the panorama correction function has been applied

If this measure does not work in some special cases (camera tilt of approximately 0°), the protective cover can be removed from the image by zooming and, if necessary, by using the purely software-based downward panning function. The displayed image section or the panorama, as the case may be, is reduced slightly but the image details are enlarged as a result of zooming.



Section 3.5 provides more details and information on how the panorama and horizon correction works (correct distortion in the image and position horizontally)

B016 Lens: Panorama Focus – One Camera, Three Views

Maximum room overview while simultaneously viewing detail in a single image: the M25 is capable of providing two more views simultaneously with the 180° panorama, allowing you to focus on two scenes in parallel (“Panorama Focus” display mode).



MOBOTIX original image Panorama/Focus



Original full image

B016 Lens: Double Panorama for a Simultaneous View in Two Directions

The “Double Panorama” display mode provides a panorama image of both halves of the area captured by the full image. Using the vPTZ functions, the panorama images can be changed as desired. The example here shows an overview panorama of the entire room, as well as the entrance, which would have otherwise no longer been visible in the panorama – a superb overview for the user.



MOBOTIX original image Double Panorama

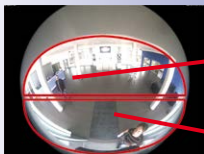

Original full image

B016 Lens: Surround View (Quad View)

The "Surround" display mode of the M25 replaces four cameras all at once and simultaneously delivers four different directions "at a glance." If the camera is installed in the ceiling and is looking straight down, all four cardinal directions can be displayed, for example.



Original image M25: Each of the four views can be modified individually



Original full image

Each of the four views features a software-controlled pan/tilt/zoom function (virtual PTZ), allowing it to be customized as necessary. In order to facilitate camera operation, the M25 can store, in addition to the preset standard views, a total of **256 user-defined camera views using the vPTZ function**, which can easily be brought up using joystick keys or softbuttons. Besides being able to manually move the virtual camera to specific positions and zoom settings, the camera can also "move" automatically. It does so by moving through the standard views or by showing the first 16 saved camera views (one after the other like in a slide show).

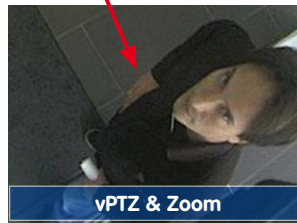

B016 Lens: Full Image and Normal View

In addition to Panorama, Double Panorama, Panorama Focus and Surround views, the M25 image can be displayed on a monitor as the original Fisheye version ("Full Image" display mode) or as the camera-corrected image section ("Normal" display mode). Switching to one of the other display modes described is possible at any time within seconds.

MOBOTIX original
image - full image



MOBOTIX original
image - Corrected and
zoomed full image

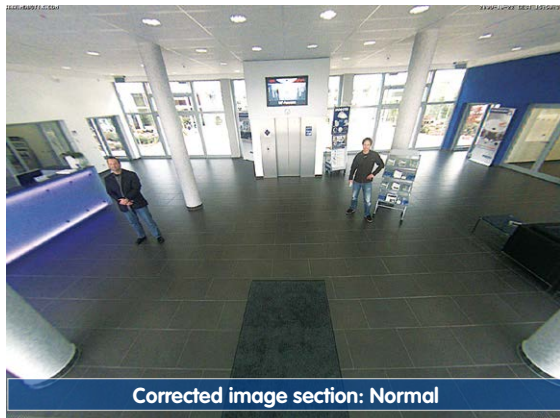

B016 Lens: Factory Settings of the Standard Views for a Wall Installation

In order to fully exploit the potential of the M25 in the desired view, it may be necessary to adjust the factory settings using the integrated vPTZ function. We have summarized the factory default settings of a wall-mounted M25 with an B016 lens (with a downward tilt of approx. 15°, 2.7 m high) here in order to give you a good idea of what to expect once the camera has been installed.



Full image (left) and "Panorama" display mode (right)

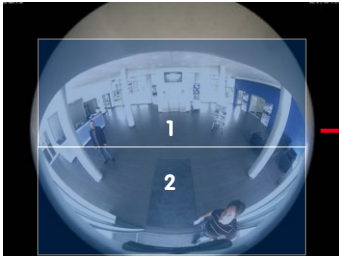

Full image (left) and "Double Panorama" display mode (right)

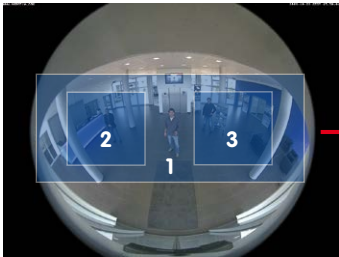

Full image (left) and "Panorama/Focus" display mode (right)

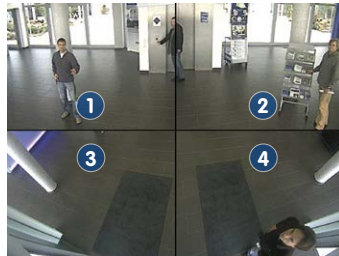

Full image (left) and "Surround" display mode (right)

1.2.1 Advantages and New Features

The high-resolution M25 Allround is a universally deployable, highly innovative and easily concealable camera system. A powerful successor to the M24M, the M25 features a six-megapixel image sensor and is clearly superior to its predecessor in terms of image quality and frame rate.

Smooth HiRes Video Streams

The modified hardware of the M25 transmits the camera's video streams even more smoothly than the high-performance M24M, even when high resolution is required. Since image streams of 16 frames per second and higher are perceived as smooth video by the human eye, the maximum frame rate is limited to 30 frames per second (when using MEGA resolution of 1280x960) in order to provide sufficient camera processing power for other tasks.

Conclusive Still Images

Thanks to the proprietary MxPEG video codec developed exclusively for MOBOTIX cameras, the cameras offer the advantage that a recording can be paused at any given point and still provide meaningful and useful snapshots due to the absence of distortion. This is essential for security applications and allows individuals or license plates to be identified, for example. In contrast, the H.264 standard, which was developed for feature movies and is favored by some video security providers, cannot achieve this with the required level of quality.

Good Color Images Even in Low Light

The more light-sensitive an image sensor is, the better the image quality, especially when the ambient light level is low, such as at dusk and in heavy rainfall. The M25 offers the best MOBOTIX image quality that is currently available thanks to the light sensitivity provided by the six-megapixel color sensor that is many times over than that of the previously used color sensors and the new MxLEO exposure control.

More Details When Zooming

The maximum zoom factor of the M25 is 1.41 times higher than that of the M24M due to the use of six-megapixel technology. This means that the degree of detail provided by the camera has improved by 41 percent. As a result, a M25 can now be installed even further away than before from the objects and areas to be monitored.

Black&White Image Sensor with 6 Megapixels

You can now order the M25 with a six-megapixel night sensor that can deliver black and white images with up to 6MP resolution. This results in larger images than those delivered by a 1.3-megapixel sensor with a perceptibly higher degree of details.

MxActivitySensor

The M25 provides an activity-controlled image analysis sensor as standard for detecting the movements of people and objects in a defined surveillance area (full image or section). The MxActivitySensor delivers reliable results particularly in outdoor area applications, in contrast to video motion detection that continues to be available and that registers all image changes in defined video motion windows. In the monitored area, the camera distinguishes between the continuous movements of vehicles, persons or objects that trigger an alarm and movements that do not set off an alarm such as shadows, changing light conditions and trees swaying in the wind.

Low Power Consumption in Accordance with PoE Standard (IEEE 802.3af)

A M25 does not use more power than its predecessor (typically 4.5 watts), despite the new sensor technology. Adjusting the PoE class via the camera software also enables the use of PoE switches that cannot be operated on all ports with PoE class 3 (up to max. 12.95 V).



1.2.2 Decentralized Video System

Usually, cameras only supply images, while processing and recording take place later on a central PC using video management software. This centralized structure has too many limitations for high-resolution video systems since it requires high network bandwidth and the PC processing power is insufficient when using several high-resolution cameras. Due to the large number of computers and servers required, traditional centralized systems are therefore becoming less suitable and cost effective.

As part of the decentralized MOBOTIX concept, every camera features a **high-speed processor**, and, if necessary, digital **long-term flash memory** (MicroSD card) can be integrated to provide several days of recording time. The computer or video control center is required only to view and control the cameras, not to evaluate and record video. This means that you do not have to rely on expensive, overloaded video management software as most of the important functions that require a large amount of processing power are integrated into the MOBOTIX cameras themselves.

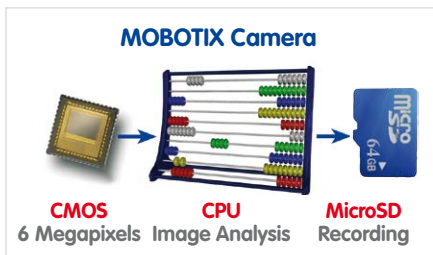

Thanks to its **integrated sensors**, MOBOTIX cameras such as the M25 automatically detect when an event has occurred. If necessary, the cameras will respond immediately with an alarm sound and will establish a direct video and sound connection to a control room.

The M25 is equipped with a **shock detector** as standard. For example, if the camera receives a blow to the housing, it can simultaneously take a video of the offender, trigger a sound alarm and notify the security company by a SIP call. Due to the build quality and absence of moving parts, MOBOTIX cameras are extremely tough. This typically allows them to stay fully operational especially when they are subject to strong vibrations.

All MOBOTIX cameras are **backlight-proof** and are not adversely affected by the glare from direct sunlight. They deliver meaningful, detailed images at all times as the camera software supports easy programming of independent exposure windows, making them ideal for rooms with large glass fronts.

In the event of an alarm, MOBOTIX M25 cameras can also record **lip-synchronous audio**. The cameras therefore play an important role in analyzing and clarifying a situation. Thanks to an integrated speaker and microphone, each individual camera can also be used for **bidirectional communication** (two-way video communication), so you can easily use the MOBOTIX App with your iPhone or iPad on the road.

The **decentralized MOBOTIX video solutions** are superior to traditional systems in all major aspects. They are also considerably cheaper to operate since they require

- **Fewer cameras** due to the more accurate detail of panorama images with megapixel technology

- **Fewer recording devices** because in the decentralized system, ten times the standard number of cameras can be used to record high-resolution HDTV video with sound on one computer/server simultaneously
- **Lower network bandwidth** because everything is processed in the camera itself and the high-resolution images therefore do not have to be constantly transported for analysis



MOBOTIX System Decentralized and Safe



Recording Software



Storage on Computer



1.2.3 Green IP Video

The modern, network-based video security technology offers numerous advantages to use energy efficiently. Due to the special product and system properties, the decision to install MOBOTIX video systems is also a decision for Green IP Video: low power consumption and environmental friendly because of long life expectancy and minimal amount of materials involved.

Low Power Consumption

MOBOTIX cameras are cost-efficiently supplied via PoE. This reduces the expenses for power and, in addition, saves copper and other important raw material as less power cabling is necessary.

Robust

MOBOTIX IP66 cameras are highly robust and work – without high-power climate control and extra protective housing – in a temperature range from -30 to $+50$ °C/ -22 to $+122$ °F.

Modern

Integrated into the cameras are high-power processors and flash storage, thus making energy-consuming servers and storage devices unnecessary. And, of course, the disposal of waste later.

High Resolution

A hemispheric MOBOTIX camera with two image sensors replaces up to eight standard cameras – including their consumption of energy and resources.

Sustainable

Without mechanical components, MOBOTIX cameras are maintenance-free and stay fully functional, even after years – and are, thus, more sustainable compared to other systems.

Forward-Looking

Even previous camera models can be easily updated and then offer new functionalities. Remote updates via Internet and the fact that the cameras are maintenance-free reduce trips by car, and, thereby, the negative effect on the environment.

Notes

Lined area for notes with horizontal dashed lines.

1.3 Technical Specifications

1.3.1 Lens Options

MOBOTIX offers the M25 with **lenses in three different classes of focal length**. Since MOBOTIX cameras are backlight-proof, none of these lenses requires a mechanical auto iris, thus making the camera extremely robust and maintenance-free. MOBOTIX lenses deliver good image quality even when using maximum digital zoom.

M25 with Standard Lenses and M14 Thread

A total of **seven different MOBOTIX lenses** are offered:

- B036 Super Wide-Angle with 103° angle of view (horizontally)
- B041 Super Wide-Angle with 90° angle of view (horizontally)
- B061 Wide-Angle with 60° angle of view (horizontally)
- B079 Wide-Angle with 45° angle of view (horizontally)
- B119 Tele with 31° angle of view (horizontally)
- B237 Tele with 15° angle of view (horizontally)
- B500 Tele with 8° angle of view (horizontally)

The standard **lenses can be exchanged at any time without having to dismantle the camera**. The camera is shipped either with a **color day sensor** or a **light-sensitive black and white sensor** for low lighting conditions (Day or Night variants).









M25 with Hemispheric Lens B016 (Fisheye)

The **hemispheric M25 model (M25-Sec-D12)** is only shipped with one B016 Fisheye lens with a **horizontal angle of view of 180° and 6 megapixel color sensor**. The lens distortion that is specific to each lens is corrected in the live image by the MOBOTIX camera software. Due to the special outdoor-optimized design of the camera, the full sensor image cannot be used with all available image display options (parts of the weatherproof housing may be visible in the image). **This model only allows using B016 lenses; other lenses cannot be used with this variant.**

M25 with CSVario Lens

The M25-CSVario is shipped with a **CS mount**, a compact **B045–100 1/2" Vario lens (58° to 28° horiz. angle of view)** and an **optional color or black and white sensor (Day/Night)**. In addition, commercial **CS and C mount lenses** (C mount lenses with adapter ring) with a diameter of up to 36 mm and a length of up to 43 mm that are designed for megapixel image sensors (1/2.5" and larger) can be used. Using other lenses will produce shadows at the image borders and will reduce image sharpness.



Lenses with 6MP Image Sensor	B016	B036	B041	B061	B079	B119	B237	B500
Original image (image format 4:3)								
35 mm equiv.	10 mm	20 mm	22 mm	32 mm	43 mm	65 mm	135 mm	270 mm
True focal length	1.6 mm	3.6 mm	4,1 mm	6,1 mm	7,9 mm	11,9 mm	23,7 mm	50 mm
Aperture	2.0	1.8	1.8	1.8	1.8	1.8	1.8	2.5
Horizontal angle of view	180°	103°	90°	60°	45°	31°	15°	8°
Vertical angle of view	180°	77°	67°	45°	34°	23°	11°	6°
At 1 m distance								
Image width	∞	2.5	2.0	1.2	0.8	0.6	0.3	0.1
Image height	∞	1.6	1.3	0.8	0.6	0.4	0.2	0.1
At 5 m distance								
Image width	∞	12.6	10.0	5.8	4.1	2.8	1.3	0.7
Image height	∞	8.0	6.6	4.1	3.7	2.0	1.0	0.5
At 10 m distance								
Image width	∞	25.1	20.0	11.5	8.3	5.5	2.6	1.3
Image height	∞	15.9	13.2	8.3	6.1	4.1	1.9	1.0
At 20 m distance								
Image width	∞	50.3	40.0	23.1	16.6	11.1	5.3	2.6
Image height	∞	31.8	26.5	16.6	12.2	8.1	3.9	1.9
At 50 m distance								
Image width	∞	125.7	100.0	57.7	41.4	27.7	13.2	6.6
Image height	∞	79.5	66.2	41.4	30.6	20.3	9.6	4.8

Notes

The name of the MOBOTIX lenses reflects the actual focal length of the lenses as well as the focal length converted to 35 mm camera format. For example, the MOBOTIX B041 Super Wide-Angle lens has a nominal focal length of 4,1 mm. Converted to 35 mm camera, this would be a lens with 22 mm focal length.

Converting the focal lengths to 35 mm camera as a known format provides for better comparing the image formats and the angles of view of the different lenses. Another benefit is that you can easily set a 35 mm camera (analog or digital) to the same focal length of the MOBOTIX lens to obtain the same angle of view. This approach greatly facilitates lens selection.

The focal lengths of MOBOTIX camera lenses refer to standard 35 mm cameras

1.3.2 Lenses, Hardware, Image Formats

Camera Model	
	M25-SEC
Lenses, Sensors	
B016 Hemispheric	•
B036 Super-Wide-Angle	•
B041 Super-Wide-Angle	•
B061 Wide-Angle	•
B079 Wide-Angle	•
B119 Tele	•
B237 Tele	•
B500 Tele	•
CSVario L27-60	•
Image sensor with individual exposure zones	Color/BW
Sensor sensitivity 6MP in lux at 1/60 s and 1 s	0.1 / 0.005 (Color) 0.02 / 0.001 (BW)
Hardware Features	
IP protection class	IP66
Temp. Internal DVR (MB)	64
Internal DVR (MicroSD, SDXC, pre-installed)	•
Microphone/speaker	•/•
Passive infrared sensor (PIR)	–
Integrated temperature sensor	•
Shock detector	•
Power consumption in Watts (typical)	< 4,5
Variable PoE class	2 – 3
Image Formats, Frame Rates and Image Storage	
Max. resolution (per sensor)	6MP (3072x2048)
Max. frame rate (MxPEG, max. resolution)	6MP : 8 fps
CIF images with 4 GB MicroSD DVR	250,000
VGA images with 4 GB MicroSD DVR	125,000
MEGA images with 4 GB MicroSD DVR	40,000
QXGA images with 4 GB MicroSD DVR	20,000

1.3.3 Software Features

<p>Camera Model</p>	
	<p>M25-SEC</p>
<p>General Features</p>	
<p>Digital zoom (continuous) with panning</p>	<p>•</p>
<p>Motion JPEG/MxPEG/H.264 codecs</p>	<p>•/•/-</p>
<p>Programmable exposure ones</p>	<p>•</p>
<p>Snapshot rec. (pre-/post-alarm images)</p>	<p>50</p>
<p>Terabyte ring buffer storage (internal/network)</p>	<p>•</p>
<p>Continuous rec. with sound (0.2 to 30 fps)</p>	<p>•</p>
<p>Event recording with sound</p>	<p>•</p>
<p>Time and event control</p>	<p>•</p>
<p>Weekly schedules/holidays</p>	<p>•</p>
<p>Web functionality (FTP, email)</p>	<p>•</p>
<p>Playback/Quad- und MultiView</p>	<p>•</p>
<p>Bidirectional sound in browser</p>	<p>•</p>
<p>Logo generator, animated</p>	<p>•</p>
<p>Flexible event logic</p>	<p>•</p>
<p>Master/Slave arming</p>	<p>•</p>
<p>Several scheduled privacy zones</p>	<p>•</p>
<p>Customized voice messages</p>	<p>•</p>
<p>VoIP telephony (audio/video, alert)</p>	<p>•</p>
<p>Remote alarm notification (network msg.)</p>	<p>•</p>
<p>Signal inputs/outputs, RS232</p>	
<p>Programming interface/HTTP API</p>	<p>•</p>
<p>Security features (HTTPS/SSL, IP-based access control, IEEE 802.1X network authentication)</p>	<p>•</p>
<p>Video Analysis</p>	
<p>Video Motion detector</p>	<p>•</p>
<p>MxAnalytics</p>	<p>-</p>
<p>MxActivitySensor</p>	<p>•</p>
<p>Video Management Software</p>	
<p>MxManagementCenter</p>	<p>•</p>
<p>MOBOTIX App</p>	<p>•</p>

Free-of-charge
download from
www.mobotix.com
or App Store

1.3.4 Technical Data

Technical Data M25	
Model variants	MX-M25-D016, MX-M25-D036, MX-M25-D041, MX-M25-D079, MX-M25-D119, MX-M25-D237, MX-M25-D500 MX-M25-N016, MX-M25-N036, MX-M25-N041, MX-M25-N079, MX-M25-N119, MX-M25-N237, MX-M25-N500
Lens options	12 to 270 mm, 35 mm format, horizontal angle 180° to 8°
Sensitivity	Color sensor: 0.1 lux at 1/60 s, 0.005 lux at 1 s Black and white sensor: 0.02 lux at 1/60 s, 0.001 lux at 1/1 s
Image sensor	1/1.8" CMOS, 6 megapixels, progressive scan
Max. image resolution	Color/Black and white: 3072x2048 (6MP)
Image formats	3072x2048 (6MP), 2592x1944 (5MP), 2048x1536 (QXGA), 1920x1080 (full HD), 1280x960 (MEGA), 1280x720 (HD), 1024x768, 800x600, 768x576 (D1-PAL), 704x576 (TV-PAL), 640x480, 384x288, 320x240, 160x120, custom formats
Max. frame rate M-JPEG (live/recording)	HD: 15 fps, MEGA: 12 fps, QXGA: 6 B/s, 5MP: 4 B/s, 6MP: 4 B/s
Max. frame rate MxPEG (live and recording including sound)	HD: 30 fps, MEGA: 30 fps, QXGA: 15 fps, 5MP: 10 B/s, 6MP: 8 fps
Image compression	MxPEG, M-JPEG, JPEG
Internal DVR	MicroSD card pre-installed (SDXC)
External video ring buffer	Directly on NAS and computer/server without additional recording software
Software (included)	MxManagementCenter MOBOTIX App for iOS devices with iOS 5.0 and higher
Image processing	Backlight compensation, automatic white balance, image distortion correction, panorama correction, Video Motion detection, MxActivitySensor
Virtual PTZ	Digital pan/tilt/zoom, continuous 8X zoom
Alarm/events	Video Motion detection, MxActivitySensor, external signal, temperature sensor, PIR, microphone, shock detector, notification over e-mail, FTP, IP telephony (VoIP, SIP), visual/acoustic alarms, pre- and post-alarm images
Mikrophone and speaker	Microphone and speaker integrated
Audio features	Lip-synchronous audio, two-way communication, audio recording
Interfaces	10/100 Ethernet, IPv4/IPv6, MiniUSB, MxBus; inputs/outputs and RS232 via accessories
Video telephony	VoIP/SIP, two-way communication, remote controlling with key code, event notification

Technical Data M25	
Security	User/group management, HTTPS/SSL, IP address filter, IEEE 802.1x, intrusion detection, digital image signature
Certifications	EMC (EN 55022, CISPR 22, EN 55024, EN 61000-6-1/2, FCC part15B, CFR 47, AS/NZS 3548)
Power supply	Year-round Power-over-Ethernet (IEEE 802.3af); variable PoE class, approx. 4.5 W
Operating conditions	IP66, -30 to +50 °C/-22 to +122 °F
Dimensions/weight M25	Wall mount: W x H x D: 140 x 189 x 222 mm/5.5 x 7.4 x 8.7 in; Weight: approx. 772 g/1.7 lb (including standard lens) Ceiling mount: W x H x D: 140 x 156 x 195 mm/ 5.5 x 6.1 x 7.7 in; Weight: approx. 715 g/1.6 lb (including standard lens)
Delivered parts	Housing (high-resistance composite, PBT), white, conversion set for ceiling mount, mounting parts, Allen wrench, 50 cm patch cable, manual, software, MicroSD card (pre-installed)



1.4 Delivered Parts and Dimensions

1.4.1 M25 Camera



Item	Quantity	Part Name
1.1	1	Camera in weatherproof housing including VarioFlex wall mount
1.2	1	Ceiling mount
1.3	1	Gasket for wall and ceiling mount
1.4	1	Lens, mounted (standard M14, CSVario, or B016)
1.5	2	Lens cover, 1 mounted, 1 replacement (cover for CSVario/B016 not shown)*
1.6	1	Lens wrench B016 (with M25-Sec-D12/N12 only)
1.7	2	Allen wrench 5 mm, Allen wrench 2.5 mm
1.8	1	Ethernet patch cable, 0.5 m, pre-installed
1.9	4	Caps for stainless steel wood screws
1.10	4	Stainless steel wood screws with hex head 6x50 mm
1.11	4	Stainless steel washers 6.4 mm
1.12	4	Screw anchors S8
1.13	2	Cable retainer with bayonet catch (patch cable, Mini USB)
1.14	1	MicroSD card pre-installed (SDXC)
1.15	1	Lock plug Mini USB

Camera Housing and Connectors

The MOBOTIX M25 consists of the camera in the weatherproof housing and the VarioFlex mount.

Connectors

- Network (Ethernet network including PoE supply)
- Mini USB (e.g. for ExtIO)
- MxBus (for MOBOTIX expansion modules)



Make sure that the **white ring** remains in the lens cover as this ring reduces light reflections and prevents the camera LEDs from adding reflections to the images

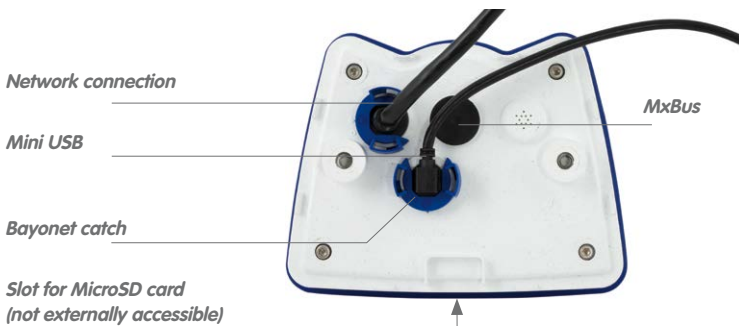
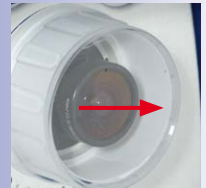

Note**Note on fastening cables leading into the camera:**

Cables passing in to the back of the camera (patch cable for the network connection and for Mini USB) are secured using a special cable retainer with bayonet catch.

When replacing this cable, ensure that the cable is properly seated in the port and that the retainer with the blue bayonet catch is locked (short clockwise turn until it clicks into place).

**Removing the Cable Retainer**

Rotate the bayonet catch anti-clockwise to the "open circle" symbol (see figure). The catch may be removed from the side. The cable can now be pulled out of the camera.

Open the cable retainer by rotating the bayonet catch to the marked position

Bayonet catch open



Caution

Only use **original MOBOTIX cable** to connect the camera. Standard cables purchased from other suppliers do not meet the necessary specifications for proper protection (no longer weatherproof according to IP66).



Ethernet patch cable



MiniUSB cable

MOBOTIX patch cables are available as accessories in different lengths (1 m, 2 m, 5 m and 10 m)

Replacing the Cable Retainer

Insert the cable into the receptacle on the camera. Position the bayonet catch from the side (opening points to the right). Rotate the bayonet catch clockwise to the "filled circle" symbol (see figure). The cable is now properly retained.



Close the cable retainer by rotating the bayonet catch to the marked position

Bayonet catch closed



1.4.2 Dimensions for Wall Installation

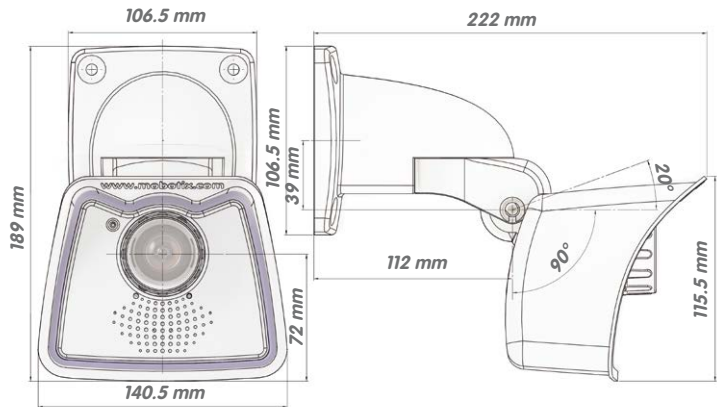

1.4.3 Dimensions for Ceiling Installation

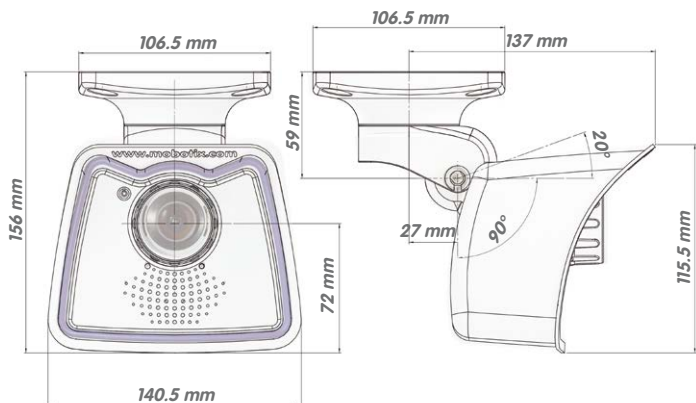

1.4.4 Dimensions of Wall Mount

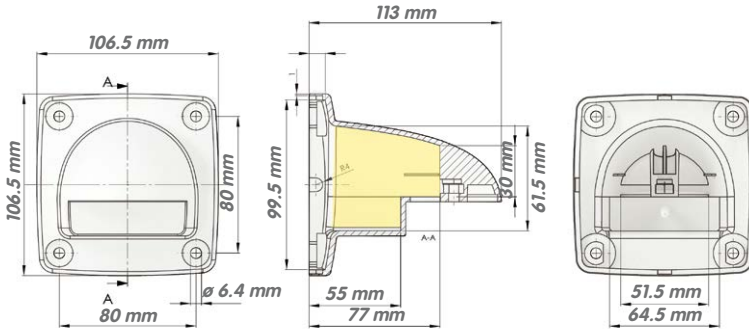

With the ceiling mount, the size of the contact surface is identical to the wall/ceiling and to the position of the drill holes

1.4.5 Drilling Template Wall and Ceiling Mount

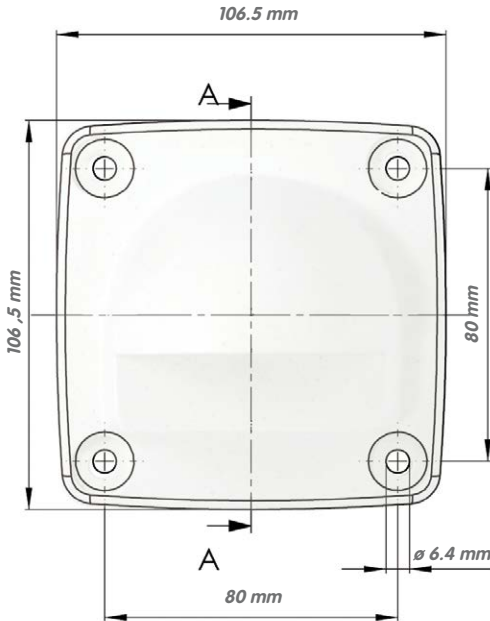

Find the drilling templates (scale 1:1) at the end of the manual as a fold-out

Note

Find the folded drilling template at the end of the manual.

Make sure that the drilling template is not scaled or adjusted to the paper size when printing the PDF file (enlarged or reduced).

1.5 Available Accessories

1.5.1 Lens Cover with Glass Pane

Order no.: *MX-M25-OPT-LCSG*

As an additional accessory, the M25 with standard lens (M14 thread) can be supplied with a protective cover that has a glass pane instead of one made of plastic. This will improve the durability of the lens cover when used in extremely rough conditions (at sea, in sand storms, etc.). This lens cover also has a thread size that fits external filters (40.5 mm x 0.5 mm) available from photo shops. For example, you could install a polarization filter to cancel out the reflections from windowpanes or windshields. Using this lens cover together with the B036/B041 Super Wide Angle lenses is not recommended, since this lens cover produces shadows at the image borders. The (longer) cover supplied with M25 models with the CSVario lens is equipped with the glass pane as standard.



MX-M25-OPT-LCSG



MX-M25-OPT-LCGL

1.5.2 Pole Mount

Order no.: *MX-MH-SecureFlex-ESWS*

If you are intending to mount the camera to a pole, you should consider using the MOBOTIX Pole Mount for M25 cameras. This mount is made of 3 mm powder-coated stainless steel (white) and has been designed specifically for outdoor use. The supplied stainless steel straps allow the mount to be attached to poles with diameters between 60 mm and 180 mm (2.4 in to 7.1 in). By design, the pole mount does not allow the use of a flush-mounted wall outlet.



1.5.3 MiniUSB Cable to MiniUSB (Straight/Angled)

Order no.: *MX-CBL-MU-EN-STR-05/2/5*
(straight/angled)

The MOBOTIX MX-232-IO-Box can be connected directly to the M25 with this cable, which is up to five meters long.



Only cables with
angled plugs can be
used for the M25

1.5.4 MiniUSB Cable to MiniUSB (Angled/Angled)

Order no.: MX-CBL-MU-EN-EN-PG-05/2/5
(angled/angled)

The MOBOTIX ExtIO can be connected directly to the M25 with this cable, which is up to five meters long.



1.5.5 MiniUSB Cable to USB-A Socket

Order no.: MX-CBL-MU-EN-AB-05/2/5

USB-based storage media (for example, USB hard drives) can be connected directly to the M25 with this cable, which is up to five meters long.



1.5.6 Ethernet Patch Cable for Bayonet Catch

Order no.: MX-OPT-CBL-LAN-1/2/5/10
(length: 1 m/2 m/5 m/10 m)

The MOBOTIX-developed special cable can be installed in a waterproof manner and has an integrated sealing gasket. Every M25 ships with a 0.5-m-long cable as standard, which can be exchanged for a patch cable up to 10 m in length.



1.5.7 NPA-PoE-Set

Order no.: MX-NPA-PoE-EU and MX-NPA-PoE-INT (Version EU and Version INT)
Order no.: MX-CBL-NPA-BAT-2 (battery cable for mobile voltage sources)

This is a multifunctional PoE injector according to the IEEE 802.3af standard – with three connectors (for network, camera/PoE device, PC), universal power supply unit with interchangeable adapter plugs and crossover function. The NPA-PoE-Set connects and remotely supplies a M25 with power via an Ethernet cable up to 100 m in length. The blue adapter can also be connected to mobile voltage sources from 12 to 57 V DC by means of an additionally available battery cable. The “EU” version of the NPA-PoE-Set is supplied as standard with a European adapter, while the “INT” version includes four adapters (EU, USA, UK, AUS).



1.5.8 MX-Overvoltage-Protection-Box

Order no.: MX-Overvoltage-Protection-Box-RJ45

Order no.: MX-Overvoltage-Protection-Box-LSA

Weatherproof network connector (protection class IP65, -30 to $+60$ °C/ -22 to $+140$ °F) **with surge protection of up to 4 kV for MOBOTIX IP cameras**, ideal for replacing the MX-Patch-Box.

At the same time, the MX-Overvoltage-Protection-Box provides a weatherproof connection of a camera's patch cable to a network patch cable (**-RJ45** variant) or a network installation cable (**-LSA** variant).



1.5.9 MX-NPA-Box

Order no.: MX-OPT-NPA1-EXT

The MX-NPA-Box is a weatherproof PoE injector conforming to the IEEE 802.3af standard and is designed to connect external voltage sources (12 to 57 V DC) to a MOBOTIX camera.

The MX-NPA-Box is equipped with the Patch-Box's weatherproof and extremely compact exterior housing (protection class IP65, -30 to $+60$ °C/ -22 to $+140$ °F), which means it can also be installed in the space of the Outdoor Wall Mount. Interfaces of the MX-NPA-Box: Camera via patch cable, Ethernet via LSA+ and external power supply via terminal connector (12 to 57 V DC possible).



1.5.10 MX-GPS-Box

Order no.: MX-OPT-GPS1-EXT

The MX-GPS-Box primarily serves as a high-precision time source for systems without an Internet connection. In addition, it can provide triggering based on GPS events (reaching or moving away from a specified position; exceeding or not reaching a specified speed). This interface box can be attached to all MOBOTIX cameras with an MxBus interface.

The MX-GPS-Box is equipped with the same compact housing as the other interface boxes (protection class IP65, -30 to $+60$ °C/ -22 to $+140$ °F). This interface box should not be installed inside of other wall mounts, but on the exterior of the building with a large section of open sky above it. This ensures the best possible reception from GPS satellites and thereby the highest possible accuracy of the received GPS data. The maximum length of the MxBus wiring (0.8 mm diameter wires) is 50 m/55 yd.



1.5.11 MX-232-IO-Box

Order no.: MX-OPT-RS1-EXT

This box provides the signal inputs and outputs as well as the RS232 (serial) interface. It replaces the connections that were handled on the older camera models via a D-Sub 15-HD connector. The MX-232-IO-Box (protection class IP65, -30 to $+60$ °C/ -22 to $+140$ °F) can be attached to all MOBOTIX cameras with an MxBus or USB interface. The maximum length of the MxBus wiring (0.8 mm diameter wires) is 50 m/55 yd. If the MiniUSB connector is used, the maximum cable length is 5 m/16 ft.



1.5.12 ExtIO Expansion Module

Order no.: MX-ExtIO

The device, which is suitable both for on-wall and in-wall installations, contains a powerful speaker, microphone, infrared motion sensor, ambient temperature sensor, two input and two output contacts and two illuminated keys. It is ideal for door communication, elevators, access control systems, etc. The ExtIO is suitable for use as direct connection to the S15 via a MiniUSB cable (max. 5 m), which can be ordered separately, or as a network connection via the PoE switch.



1.5.13 Mx2wire+ Media Converter

Order no.: MX-2wirePlus-Set-PW

The Mx2wire+ system allows an Ethernet network with PoE to be set up via two-wire cables, which saves users from having to lay several hundred meters of Ethernet cable. For example, an existing two-wire cable of an analog video camera can be reused to connect a high-resolution and modern IP network camera. Mx2wire+ is delivered in the standard wall outlet frame in different designs; however, it can also be used with the available on-wall socket that is included.



1.5.14 Security Screw Set with Allen Bit

Order no.: MX-OPT-SEC-SCREWS-SET

Use this triple set of security screws for plugs (4 pcs 6x50) and for machine threads (4 pcs M6x15, 4 pcs M6x30) to securely attach the VarioFlex foot of the wall mount. The Allen bit supplied with the set (1/4 in drive with hole for security pin) fits regular power screwdrivers.

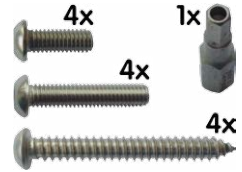

1.5.15 Other Accessories

Since the range of accessories for the MOBOTIX system keeps growing, you should visit the MOBOTIX website www.mobotix.com in the **Products > Accessories** section to see the entire list of available accessories.

THE MOBOTIX INFORMATION CHANNELS



Support on the MOBOTIX Website
www.mobotix.com/other/Support



The MOBOTIX Video Tutorials
www.mobotix.com/other/Support/Tutorials



Seminars on MOBOTIX Campus
www.mobotix.com/other/Partners/Seminars



The MOBOTIX YouTube Channel
www.youtube.com/MOBOTIXAG



1.6 MOBOTIX Software

1.6.1 Integrated Camera Software (Firmware)

MOBOTIX cameras and connected MxBus modules operate with built-in firmware whose functions are accessed by the MOBOTIX **MxManagementCenter** remote stations and **MOBOTIX App**.

The M25 models therefore also feature a variety of functions that are integrated in the firmware: from motion detection and long-term storage right through to alarm notification via video IP telephony. The virtual PTZ functions allow you to continuously zoom into or out of a MOBOTIX camera image using either the mouse wheel or a joystick.

When recording image or video sequences, you can choose to store either the section of the live image that is visible or the full sensor image (full image storage). This also allows you to examine parts of an image or video that had not been visible in the live image section on display at the time of the recording.

Unlike in the camera systems from other manufacturers, there is no need to buy an install additional software on your computer thanks to the MOBOTIX firmware that can be accessed directly in a web browser via the camera IP address. Instead of using a web browser, you can also download the free **MxManagementCenter** video management software from the MOBOTIX website (www.mobotix.com > **Support**) to quickly display multiple cameras on one monitor or on an entire video wall, switch alarms with sound or conveniently search for an event. The **MOBOTIX App** for iOS devices (iPhone, iPad, iPod mini, iPod touch, iOS version 5.0 and higher) is also available free of charge from the **App Store** for your mobile applications.

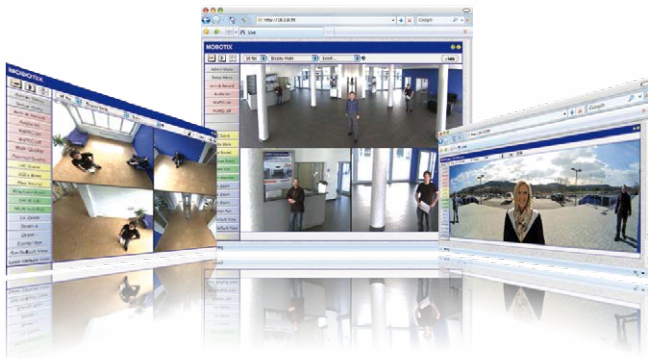

Download free of charge from www.mobotix.com

No license fees
Free updates

Download free of charge from www.mobotix.com

No license fees
Free updates



1.6.2 MxManagementCenter

MxManagementCenter (MxMC) is a completely new development that focuses on a unique and intuitive user experience. Single and double click, drag&drop, support of several screens and direct view of events and alarm messages are just some of the many advantages of the new software.

MxManagementCenter is perfectly designed in combination with MOBOTIX cameras representing the decentralized concept at its best. MxMC allows controlled recording access via the camera or later directly to the NAS.

A unique feature is the adaptive bandwidth management supporting quality search even over mobile networks with very limited bandwidth. MxMC is 100% free of charge, requiring no license or update costs and at the same time having no limits in terms of users, screens and cameras.

MxManagementCenter – simple operation of the most important camera functions:

- Integration of an unlimited number of cameras
- Camera groups with representation in Grid and Graphic views, Grid views with a focus window and many controls
- Optical and audible alarming of new events
- Instant Player that allows for quick viewing of the latest events during live video monitoring operation
- Easy use of multiple monitors by double-clicking on the live image, grid or event image
- Door station functions (intercom, open door, turn light on/off, etc.)
- Subsequent distortion correction of hemispheric camera images - in live images and in recordings

Download free of charge
from www.mobotix.com

No license fees
Free updates



1.6.3 MOBOTIX App

Premium solution: There for you whenever and wherever you need it, the MOBOTIX App serves as the perfect remote mobile station that uses intelligent detailed solutions to increase security and convenience for users on a daily basis. The controls are optimized for use with touchscreen devices and feature three main views (Live, Player, Events), self-explanatory symbols, large software buttons, multifunctional sliders developed by MOBOTIX as well as simple gestures like swipe and tap, making it easy for newcomers and older users to work with professional security equipment. In addition, using mobile devices to operate the various functions such as door opening, activating the voice mailbox, switching the door bell off at night and switching a light on/off, creates added value in the form of greater convenience and security in every day life.

MOBOTIX App – Mobile Remote Station for MOBOTIX Cameras and Door Stations

- Bandwidth-optimized remote access via WLAN (WiFi) or the Internet
- Live images and recordings in the best MOBOTIX HiRes quality
- Two-way communication, door opening and video mailbox access
- Doorbell and alarm notifications, protection of privacy
- Convenient search functions, playback of external MxPEG videos
- Grouping of cameras and filtering of events
- Free from the **App Store** for the iPad, iPad mini, iPhone and iPod touch



Free download from the **App Store**

No license fees
Free updates

2 INSTALLATION

Although the MOBOTIX M25 has been primarily designed for installation on walls and ceilings, it can also be installed on a mounting pole using the appropriate MOBOTIX accessories. The different installation options are described in *Section 2.2, «Mounting the Camera with Wall Mount»* and the following sections, while the drilling templates are included at the end of the manual.

2.1 Preparing the Installation

Before mounting the MOBOTIX M25, the following questions should be answered:

1. Where will the camera be mounted?
2. Which other mounting options are available?
3. How is the camera connected to the network and how is the power supplied?
4. How are the connections furnished from the building?
5. What cabling considerations are necessary?

The following sections contain answers to each of these questions. If you have more detailed questions, please ask your MOBOTIX partner directly or contact the MOBOTIX support. To find the contact data, please open www.mobotix.com and the **Support** section.

2.1.1 Mounting Options: Wall, Ceiling, Pole

Like all MOBOTIX cameras, the M25 is **extremely flexible** in terms of how and where it can be installed. An M25 can be used for both indoor and outdoor applications. In fixed or mobile applications – constantly changing locations or in/on vehicles of any kind. The M25 cameras are **weatherproof according to IP66** and can work reliably in temperatures ranging from -30 to $+50$ °C / -22 to $+122$ °F without extra housing, heating or fan. A practical sun protective cover is integrated into the extremely resistant housing, which is made of UV-resistant special-purpose plastic.

Thanks to the camera's unique VarioFlex mounting system (supplied as standard), the camera can be mounted quickly and easily on any wall, ceiling or even a round pole of up to 18 cm diameter (when combined with the stainless steel pole mount). The VarioFlex mounting system allows a wide positioning range in both the horizontal and vertical directions (rotating and tilting) to enable precise adjustment to suit the area to be monitored. **The wall mount also fits directly over flush-mounted RJ45 sockets (without the frame) and MOBOTIX interface boxes** to fully conceal the cable, thus improving the security of the installation.

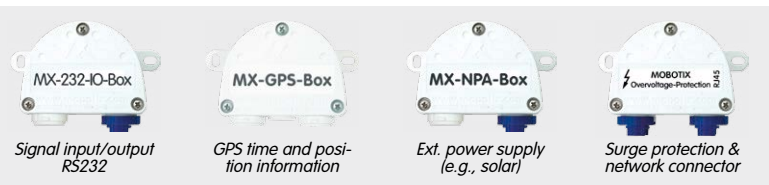

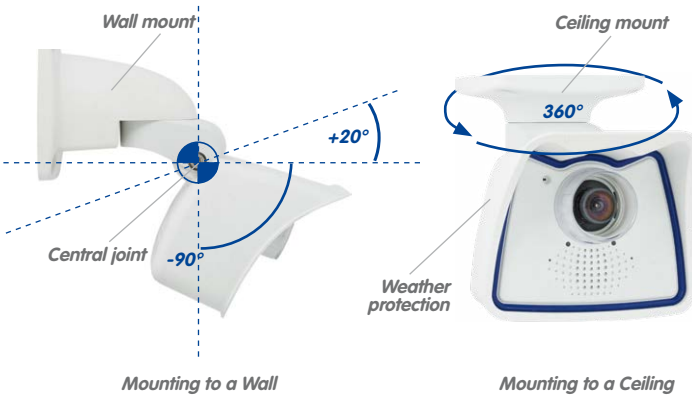

Turning/tilting mounted to wall

- horizontally: 180°
- vertically: -90° to +20°

Turning/tilting mounted to ceiling

- horizontally: 360°
- vertically: -90° to +20°

The VarioFlex mount consists of a central joint, which is directly screwed into place with the weatherproof M25 housing, and a wall and ceiling mount, which is fastened to the central joint with just one screw. In addition to being easy to install, the VarioFlex mount enjoys the advantage of a **completely concealed cabling** and high impermeability to water and dust (IP66). Wall and ceiling mounts are designed so that they can be mounted over conventional flush-mounted sockets (without the frame) or cavity sockets and conceal them completely. In addition, the wall mount easily covers a MOBOTIX interface box.

Space for RJ45 wall outlet/concealed cabling



VarioFlex wall mount with concealed cabling, covering flush-mounted sockets and MOBOTIX Interface boxes

Before attempting to mount the camera to a wall or ceiling, make sure that you have found the best camera position. It is important that the camera's field of view is not obstructed in any way. Once the camera has been mounted to a wall or ceiling, you can fine-tune its position. If the monitored area changes from time to time or the camera has to be installed in a different location, the camera lens can be exchanged in just a few easy steps and used, without having to upgrade to new video software.

Mounting to a Wall

The M25 can be mounted to the wall of a building or structures, even mobile surfaces, for both indoor and outdoor use. The camera is mounted using the pre-installed **VarioFlex mount (supplied as standard)**, which is easily secured using the four enclosed screws and screw anchors (depending on the surface, it can also be mounted without screw anchors directly over the flush-mounted socket). The Ethernet connection cable of the camera has already been guided through the mount and simply needs to be connected with the network cable (e.g., by using an MX-Overvoltage-Protection-Box). By adjusting the VarioFlex mount as required, the captured image area can be precisely adjusted to the desired practical application. **The camera can be turned or tilted 180° horizontally and 110° vertically (from -90° to +20°).**

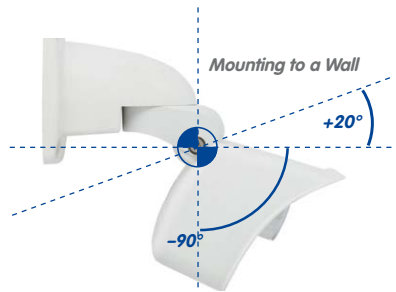

Wall-mounted

- horizontally: 180°
- vertically: -90° to +20°

Mounting to a Ceiling

By exchanging the wall mount for the separately supplied ceiling mount, the M25 is ready to be **mounted to ceilings in just a few easy steps** thanks to the VarioFlex system. This mounting option is of particular benefit when monitoring rectangular rooms with a single camera. In such cases, the Super Wide Angle lenses B036 and B041 allow the room to be monitored almost entirely by an M25 mounted to the ceiling in one of the corners. Using the software-driven PTZ, you can easily zoom in on image details in either the live image or the recording. **The camera can be turned or tilted 360° horizontally and 110° vertically (from -90° to +20°).**



Ceiling-mounted

- horizontally: 360°
- vertically: -90° to +20°

Mounting the Camera with Pole Mount

Especially when using the camera in mobile outdoor scenarios (e.g., for surveillance of construction sites), the camera is often installed on round poles. In such cases, MOBOTIX recommends using the virtually indestructible pole mount (MX-MH-SecureFlex-ESWS) that is available as accessory for the M25. This pole mount is made from white, powder-coated stainless steel and is used in combination with the pre-installed VarioFlex wall mount of the camera.

You can attach the mount to poles with diameters between 60 mm and 180 mm/2.4 in to 7.1 in. Best results are obtained when using high metal poles, since they allow running the network cabling inside, well-protected from tampering. For more detailed information on the installation process, see *Section 2.2, «Mounting the Camera with Wall Mount»* and the following sections, while the drilling templates are included at the end of the manual.



2.1.2 Mounting with Hemispheric Lens B016

The camera must be correctly positioned at the wall or ceiling in order to be able to use the high-resolution hemispheric image display option of the M25 with hemispherical B016 lens. The entire hemisphere of the room in front of the camera is then effectively monitored.

High-Resolution Panorama Images

The M25 with B016 lens is primarily suited to providing an excellent **overview in the form of a high-resolution panorama image**, and less suitable for more exact details. For active operation, the camera should be mounted at an (out of direct reach) **height ranging from 2.50 m to 3.50 m**. Facial recognition up to **1.50 m (5 ft)** distance to the object is very good and up to **3 m (9.8 ft)** is still sufficient. Objects can be recognized even at distances of **5 m and more from the camera**. During installation, ensure that the camera is focused on the most important areas of the room as directly as possible, in order to optimize image quality and to provide the desired level of detail recognition. This applies above all to wall and ceiling installations that must be carried out at greater heights for technical or other reasons (over doors, windows, etc.). Only by tilting the camera appropriately can the lens capabilities be fully utilized.

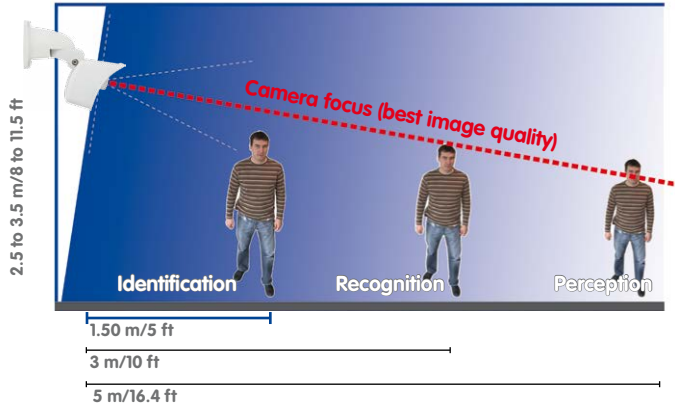

MOBOTIX recommendation



MOBOTIX original image of 180° panorama (B016 lens)

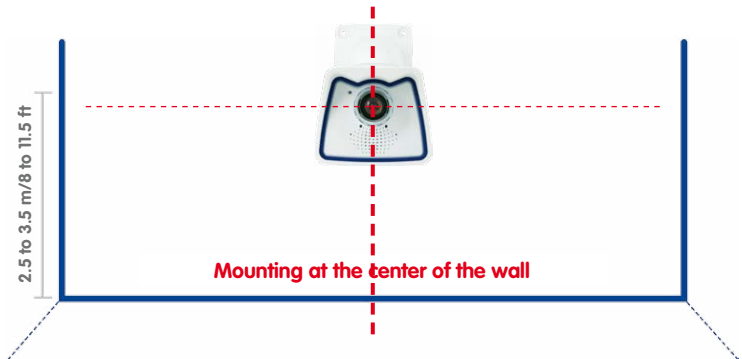

Allround View

Thanks to its hemispheric lens, a single M25 can monitor an entire room right including the four corners (360° Allround View). The camera's ideal position is on the ceiling in the center of the room. Rooms with a square floor area of up to approx. 40 m² (48 yd²) in general allow recognizing details even at the borders of the full image. If you would only like to know if persons enter a room or for monitoring specific objects, rooms with more than 100 m² (120 yd²) floor area can be monitored using a single camera.

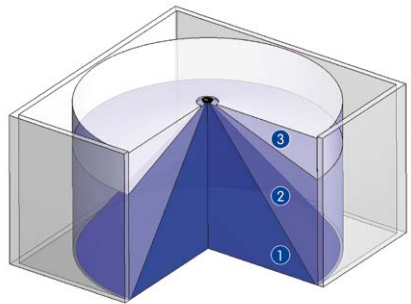
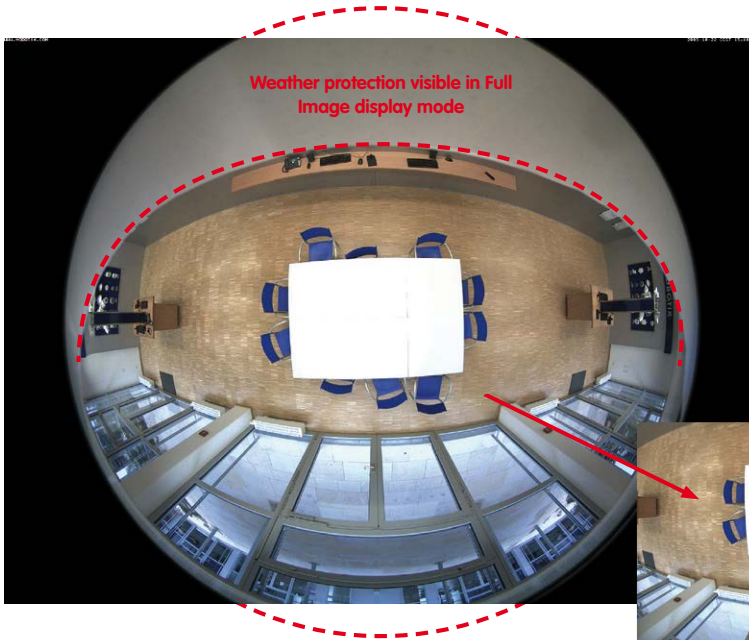

Image quality (precision) diminishes as the distance of an object to the camera focal point increases:
 1 very good, 2 good, 3 satisfactory

Captures an entire room

Furthermore, the "camera view from top to bottom" can also be achieved by mounting the camera to a wall or a pole at a tilt of 90°.



By panning/tilting/zooming the image, the concealed area can be completely removed from the image

Note

Part of the captured image area (especially in full image display mode) is concealed behind the protective cover of the M25 housing. For this reason, M25 cameras with B016 lens should be adjusted so that the concealed areas are not those that are supposed to be monitored. By panning/tilting/zooming the image, the concealed area can be completely removed from the image.

2.1.3 Network Connection and Power Supply, UPS

Power Over Ethernet (PoE Conforming to IEEE 802.3af)

All M25 models are supplied with power using the PoE standard. The Network Power Adapter (MX-NPA-PoE-Set) may be used for smaller installations. For larger installations, it is worth investing in a PoE capable supply device available on the market.

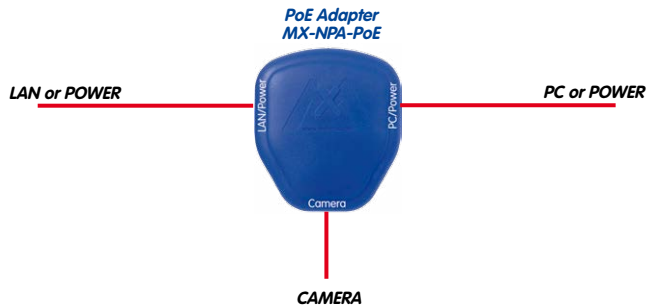

When directly connecting to the computer, the PoE adapter replaces a cross-over cable



The **maximum length** of the network cable for power supply over an Ethernet cable is **100 m**. The Mx2wire+ media converter set (available as an accessory) can be used to extend the range of an Ethernet connection up to 500 m in length (maximum transmission speed for a 500-m cable: 45 Mbps and 12 W for the PoE device).

Note

The MOBOTIX M25 can be powered by switches or routers which support the PoE (Power-over-Ethernet) standard and conform to IEEE 802.3af.

Advantages of PoE power supply:

- Allows setting up centralized backup power supply via the network.
- Reduces energy consumption.
- No extra network connection for camera required.

Using Uninterruptible Power Supplies (UPS)

You should install an uninterruptible power supply (UPS) in order to maintain a continuous power supply even when utility power fails. These devices also provide full protection against electrical surges and voltage fluctuations, enhancing the reliability of the system as a whole.

When using a more powerful 19" rack-mounted UPS, you can also protect all other network components (for example, switches, routers, PoE switches, etc.).

Since MOBOTIX cameras do not require any heating, even during winter, the average power consumption of less than 5 watts is very low. This, in turn, means that you can centralize the UPS-protected power supply by injecting power into the Ethernet cables (max. 100 m). This kind of protected power supply can be used either with MOBOTIX PoE products (MX-NPA-PoE + Universal Power Supply) or with PoE-compliant switches according to IEEE 802.3af.



2.1.4 Preparing the Camera Connections, MX-Overvoltage-Protection-Box

Once the camera position, the position of the cable outlets and the method of power supply have been decided upon, the cabling can be installed. Before installing the MOBOTIX M25, you should make sure that the network connections have been properly tested so that the proper functioning of the camera is guaranteed.

If the camera is to be installed outdoors, you should also install the MOBOTIX MX-Overvoltage-Protection-Box (optional accessory). This interface box not only provides **overvoltage protection of up to 4 kV for MOBOTIX IP cameras**, it also provides simple and weatherproof connection of the cameras to a network patch cable (-RJ45 variant) or a network installation cable (-LSA variant).

For additional information on the MX-Overvoltage-Protection-Box, open the **Products > Accessories > Interface Boxes** section on www.mobotix.com.

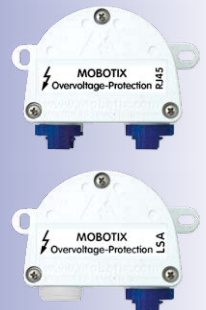

UPS units not only protect the camera against power failures, they also protect all other connected network devices against damage from voltage peaks and lows

2.1.5 Wiring, Fire Prevention, Lightning and Surge Protection

When installing the wiring inside or outside of buildings, make sure you always adhere to the relevant regulations on wiring, fire prevention and protection against lightning.

MOBOTIX cameras are protected against the effects of small electrical surges by a range of measures. These measures, however, cannot prevent the camera from being damaged when stronger electrical surges occur. Particular care should be taken when installing the camera outside to ensure proper **protection against lightning**, as this also protects the building and the entire network infrastructure.

MOBOTIX recommends having MOBOTIX cameras installed only by certified specialists accustomed to installing network devices and having proper respect for the applicable regulations regarding lightning protection and fire prevention as well as the current technology for preventing damages from electrical surges.

Guidelines for Wiring

- **Data cable:** Make sure you only use double-shielded CAT5 or higher cable (**S/STP**) for Ethernet connections.
- **Outdoors:** Installing the camera outdoors requires special precautions and measures regarding the cables as well as lightning and surge protection (see below).
- **Wire lengths:** The cable segments must not exceed the maximum allowed cable lengths in order to ensure proper data transfer (see *Section 2.7*).
- **Avoiding induction:** When running data cables parallel to existing regular power lines or high-voltage wires, make sure you observe the minimum distances to the power cables.



Fire Prevention

When installing the power lines to the camera, make sure you always adhere to the country-specific regulations (e.g. VDE in Germany, IEEE in the USA) in effect on wiring and fire prevention at the site of the installation.

Lightning and Surge Protection

In order to avoid damage to MOBOTIX cameras from overvoltages, you should always install the MX-Overvoltage-Protection-Box. This competitively priced and weatherproof network connector provides reliable protection against overvoltages of up to 4 kV; the box is easily installed in the Outdoor Wall Mount, for example (see *Section 1.5.8, «MX-Overvoltage-Protection-Box»*).

More information is available at an institution such as the International Electrotechnical Commission (IEC, www.iec.ch) or at a manufacturer of protection devices against lightning and electrical surges, such as Dehn (www.dehn.de).



2.2 Mounting the Camera with Wall Mount



The M25 is a versatile camera designed for use in indoor and outdoor applications. The camera must always be installed with the VarioFlex mount, which has been prepared at the factory for wall mounting and allows the cabling to be concealed. The best camera position for the selected lens must be found before mounting the camera to the wall (see Section 2.1.1, «Mounting Options: Wall, Ceiling, Pole» and Section 2.1.2, «Mounting with Hemispheric Lens B016»). Once the camera has been mounted to the wall, you can fine-tune its position. **Please read the notes on protecting the camera against condensation (see Section 3.6.1).**

See Section 3.6.1, «Protecting the Camera Against Condensation»



2.2.1 VarioFlex Wall Mount

Using the VarioFlex Wall Mount, the camera can be precisely panned, both **horizontally and vertically**, to suit the area that is to be monitored.

When mounted to a wall, the camera can be turned or tilted as follows:

- horizontally: 180°
- vertically: 110°

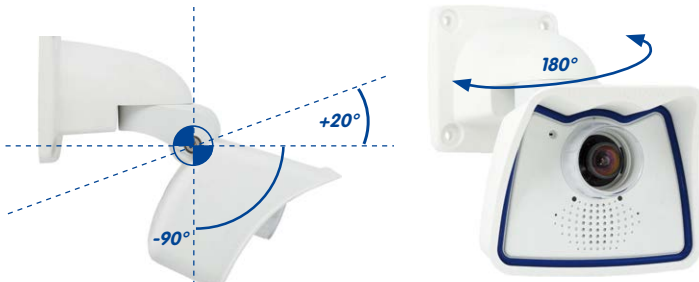

Turning/tilting mounted to wall:
• horizontally: 180°
• vertically: 110°



MX-Overvoltage-Protection-Box
in Wall Mount



Pliers to break out
cable guides



In order to ensure a flush finish with the surface, connect the camera patch cable to the **network cable using a standard adapter** that is protected in the wall mount or install an MX-Overvoltage-Protection-Box, which is easily installed in the cavity of the VarioFlex wall mount. For additional information on the MX-Overvoltage-Protection-Box, open the **Products > Accessories > Interface Boxes** section on www.mobotix.com. Note that you can also **install a flush-mounted socket with RJ45 connectors**. In this case, make sure that the outlet lines up with the upper rim of the mount later on.

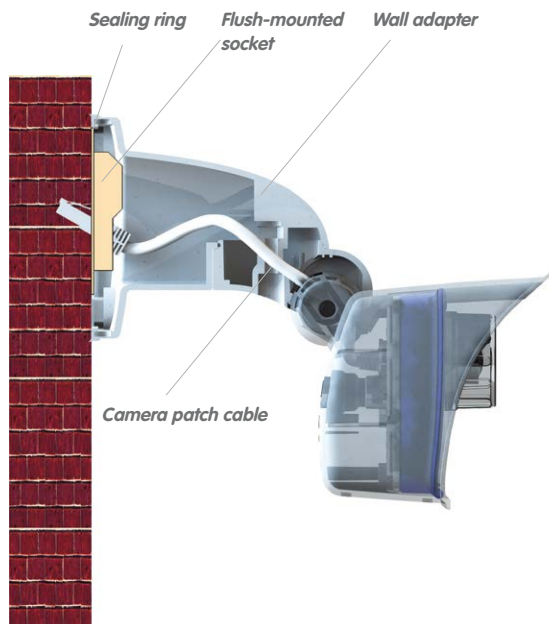

When installing **on-wall cabling**, breaking out one of the four possible openings in the base of the wall mount will ensure that the cables can be fed neatly into the camera. The connection to the camera patch cable can be established using a suitable adapter within the wall mount

Caution: If using the wall mount outdoors, only use the opening at the bottom to prevent water from entering the mount!



Procedure

1. **Install and prepare the network connection:** The pre-installed camera patch cable must be connected with the on-site network cable. The connection can either be established using an installed flush-mounted socket with RJ45 connector or – in the case of a protruding network or patch cable – using the MX-Overvoltage-Protection-Box. In both cases, the connection is well protected and is neither accessible nor visible from the outside.



2. **Drill the holes:** Use the supplied drilling template for the camera (found at the end of the manual). Drill the holes for the supplied screw anchors. Screw anchors do not have to be fitted if the surface is made of wood. To secure the mount, the supplied stainless steel hex head screws will later be screwed directly into the surface. In order to facilitate screwing in wood, the positions should first be predrilled using a 2 mm drill bit, for example (drilling depth just slightly less than screw length).

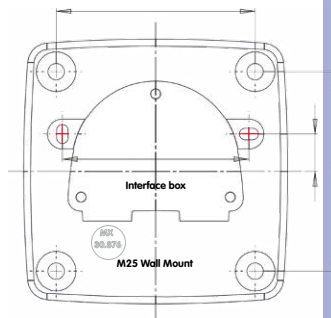

No screw anchors are required in wooden surfaces

3. **Attach wall seal:** Place the white rubber seal with the groove on the edge of the wall mount.



4. **Connect the cable:** Connect the on-site network cable to the camera patch cable using an adapter or insert the patch cable into the RJ45 outlet. When using an MX-Overvoltage-Protection-Box, follow the installation instructions supplied with the product. You can download the PDF file from the MOBOTIX website www.mobotix.com in the **Support > Manuals** section. Make sure that the cables are not bent or squashed.



Additional seal possible (e.g., heat shrink tube)





Screw caps for fastening screws

- Attach the camera:** Place the wall mount over the drill holes and hold it against the wall. Then use the four screws each with a washer and tighten them using the appropriate wrench. Do not overtighten the screws as this may damage the plastic mount. Check that the screws are securely in place and place the white caps on the screw heads. Then position the camera as described in *Section 3.2*.



- Clean the lens cover:** Once you have removed the white protective foil fixed to the front of the lens cover, clean the cover that has already been screwed on with a clean soft cotton cloth for optimal image results. The cover does not have to be removed.



- Establish a connection to the camera, check the image:** Establish a connection to the camera as described in *Section 3.1*, «Manual and Automatic Operation – Overview» and the following sections. The live image from the camera should be visible on the computer monitor. Check the image section on the computer monitor.

Note

Make sure that you always use the **VarioFlex Mount** with **ceiling adapter** when **installing to ceilings** (see *Section 2.3*, «Mounting the Camera with Ceiling Mount»).

2.3 Mounting the Camera with Ceiling Mount



The M25 is an allround camera designed for use in indoor and outdoor applications. The camera is always installed together with the VarioFlex mount, which has been prepared at the factory for wall mounting and can be converted to a ceiling mount with just few single touches. The best camera position for the selected lens must be found before mounting the camera to a ceiling, or to an overhang or balcony (see *Section 2.1.1, «Mounting Options: Wall, Ceiling, Pole»* and *Section 2.1.2, «Mounting with Hemispheric Lens B016»*). Once the camera has been mounted to the wall, you can fine-tune its position. **Please also read the notes on protecting the camera against condensation (see Section 3.6.7).**

2.3.1 VarioFlex Ceiling Mount

Using the VarioFlex Ceiling Mount, the camera can be precisely panned, **both horizontally and vertically**, to suit the area that is to be monitored.

When mounted to a ceiling, the camera can be **turned or tilted** as follows:

- horizontally: 360°
- vertically: 110°

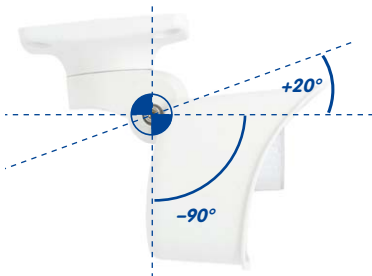

See Section 3.6.1, «Protecting the Camera Against Condensation»



Turning/tilting mounted to ceiling:
• horizontally: 360°
• vertically: 110°

In addition, a cavity or flush-mounted socket can be installed for the network cable protruding from the ceiling, which allows sufficient space to connect the network cable with the camera patch cable using a standard adapter.

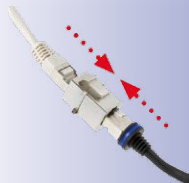

Standard adapter for connecting cables

Additional sealing of wall mount with silicone recommended (at the wall sealing), if surface is not even

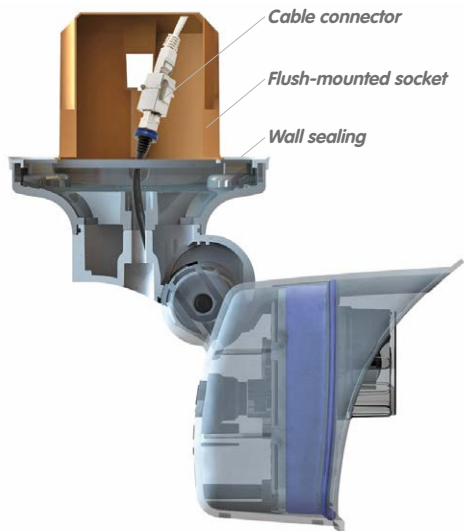

Pliers to break out cable guides



When installing **on-wall cabling**, breaking out one of the four provided openings in the base of the ceiling mount will ensure that the cables can be fed neatly into the camera. The camera patch cable must be connected to the network cable using a suitably sealed adapter.

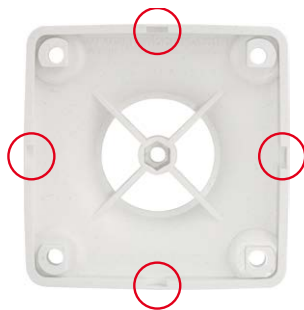

Procedure

1. **Convert to ceiling mount:** Simply remove the lock screw on the central joint and exchange the wall mount for the supplied ceiling mount. Before fastening the ceiling mount to the central joint (using the screw of the wall mount), the patch cable is guided through one of the four openings.



2. **Install and prepare the network connection:** Guide the pre-installed camera patch cable through one of the four openings in the ceiling mount. This will be connected later with the network cable using a suitable adapter, for example, in a pre-installed cavity socket.



3. **Drill the holes:** Use the supplied drilling template for the camera (found at the end of the manual). Drill the holes for the supplied screw anchors. Screw anchors do not have to be fitted if the surface is made of wood. To secure the mount, the supplied stainless steel hex head screws will later be screwed directly into the surface. In order to facilitate screwing in wood, the positions should first be predrilled using a 2 mm drill bit, for example (drilling depth just slightly less than screw length).

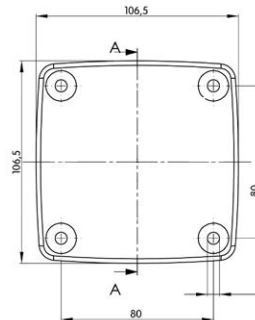

No screw anchors are required in wooden surfaces

4. **Attach ceiling seal:** Place the white rubber seal with the groove on the edge of the ceiling mount.





Screw caps for fastening screws

5. **Connect the cable:** Connect camera patch cable via connector. Make sure that the cable is not bent or squashed.
6. **Attach the camera:** Place the ceiling mount over the drill holes, use the four screws each with a washer and tighten them using the appropriate wrench. Do not overtighten the screws as this may damage the plastic mount. Check that the screws are securely in place and place the white caps on the screw heads. Then position the camera as described in *Section 3.2*.



7. **Clean the lens cover:** Once you have removed the white protective foil fixed to the front of the lens cover, clean the cover that has already been screwed on with a clean soft cotton cloth for optimal image results. The cover does not have to be removed.



8. **Establish a connection to the camera, check the image:** Establish a connection to the camera as described in *Section 3.1, «Manual and Automatic Operation – Overview»* and the following sections. The live image from the camera should be visible on the computer monitor. Check the image section on the computer monitor.

Note

Make sure that you always use the **VarioFlex mount** with **wall adapter** when **installing to walls** (see *Section 2.2, «Mounting the Camera with Wall Mount»*).

2.4 Mounting the Camera with Pole Mount (Accessory)



If you are intending to mount the camera on a pole, you should consider using the MOBOTIX M25 Pole Mount. This mount is made of 3 mm powder-coated stainless steel (white) and has been designed specifically for outdoor use. The supplied stainless steel straps allow attaching the mount to poles with diameters between 60 and 180 mm (2.4 to 7.1 in). By design, the Pole Mount does not allow using a flush-mounted wall outlet. In order to ensure a weatherproof connection of the network devices, it is recommended to use an MX-Overvoltage-Protection-Box, which is easily installed in the cavity of the VarioFlex wall mount. For additional information on the MX-Overvoltage-Protection-Box, open the **Products > Accessories > Interface Boxes** on www.mobotix.com.

The camera is always installed together with the VarioFlex mount, which has been prepared at the factory for wall mounting and which is easily attached to the Pole Mount. The best camera position for the selected lens must be found before installing the camera (see *Section 2.1, «Preparing the Installation»*). Once the camera has been mounted to the pole, you can fine-tune its position.



2.4.1 Pole Mount (MX-MH-SecureFlex-ESWS)

Using the pre-installed VarioFlex Wall Mount, which is secured to the pole mount simply using four screws and nuts, the camera can be precisely panned, both horizontally and vertically, to suit the area that is to be monitored.

When mounted to a pole, the camera can be turned or tilted as follows, just like wall installation:

- horizontally: 180°
- vertically: 110°

Schwenkbarkeit bei Mastmontage:

- horizontally: 180°
- vertically: 110°

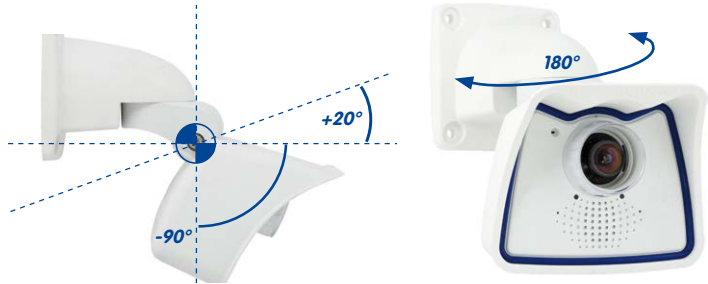

Pole Mount Dimensions



Scope of Delivery and Required Parts

Please first check that all the components supplied with the Corner and Pole Mount Set are present in the original packaging.

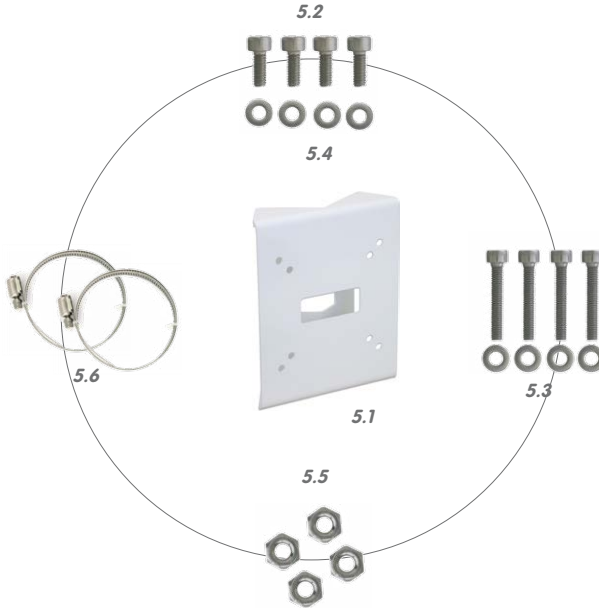

Item	Count	Part Name
5.1	1	Pole Mount
5.2	4	Stainless steel screws with hex head M6x20 mm
5.3	4	Stainless steel screws with hex head M6x35 mm (not used)
5.4	8	Stainless steel washers
5.5	4	Stainless steel lock nuts M6
5.6	2	Stainless steel straps

In addition, you will need the screw caps for fastening screws supplied with the M25 (see Section 1.4, «Delivered Parts and Dimensions», item M.10).



Screw caps M.10

Procedure

1. **Prepare the cable:** Guide the on-site network cable from behind through the middle opening of the pole mount. Ideally, the cable should be guided directly from the pole into the cavity socket of the VarioFlex Wall Mount, where it is connected with the camera patch cable via an adapter (e.g., the MX-Overvoltage-Protection-Box) to conceal the cabling.



2. **Prepare the straps:** Guide the two stainless steel straps through the pole mount. The pole must have a diameter between 60 mm and 180 mm.



3. **Attach pole mount:** Place the straps around the pole and tighten them using the screwdriver. If required, clip the ends of the stainless steel straps.



4. **Apply rubber seal:** Place the white rubber seal with the groove on the edge of the wall mount.



5. **Connect the cable:** Connect the on-site network cable to the camera patch cable using an adapter or insert the patch cable into the RJ45 outlet. When using a MX-Overvoltage-Protection-Box, follow the installation instructions supplied with the product. You can download the PDF file from the MOBOTIX website www.mobotix.com in the **Support > Manuals** section. Make sure that the cables are not bent or squashed.



- Attach the camera:** Place the wall mount over the predrilled positions in the pole mount and tighten it using the supplied M6x25 mm screws (item 2.2), washers (item 2.4) and M6 hex nuts (item 2.5). Place the white caps on the screw heads. Then position the camera as described in *Section 3.2*.



Screw caps for fastening screws

- Clean the lens cover:** Once you have removed the white protective foil fixed to the front of the lens cover, clean the cover that has already been screwed on with a clean soft cotton cloth for optimal image results. The cover does not have to be removed.



- Establish a connection to the camera, check the image:** Establish a connection to the camera as described in *Section 3.1, «Manual and Automatic Operation – Overview»* and the following sections. The live image from the camera should be visible on the computer monitor. Check the image section on the computer monitor.

Note

Make sure that you always use the **VarioFlex mount** with **wall adapter** when **installing to poles**. Der VarioFlex Ceiling Mount is **not** to be used.

2.5 Adjusting the Camera and Exchanging the Lens

2.5.1 Adjusting the Camera

1. Establish a connection to the camera as described in *Section 3.2, «First Images and the Most Important Settings»*. The live image from the camera should be visible on the computer monitor.
2. **Loosen the screws on the VarioFlex mount using the supplied Allen wrench** so that you can easily turn and tilt the camera.
3. Display the desired camera section on the computer monitor, then turn and tilt the camera until you have found the best position and sharpness. Retighten the screws of the VarioFlex mount to prevent the position of the camera from changing.
4. If required, clean the lens cap's surfaces using a clean, lint-free cotton cloth.



For more detailed information on the OnScreen Control, see *Section 3.5*



Horizontal correction



Rotate image up to $+30^\circ$



Rotate image up to $+30^\circ$

2.5.2 Correcting the Image Horizon (for B016 Lens Only)

The M25-Sec with hemispheric B016 lens allows the correction of an uneven image horizon via OnScreen Control that was possibly caused by the installation position. The image horizon can be adjusted by up to 30 degrees clockwise or counterclockwise and can be optically straightened by clicking on the corresponding icons (see image).

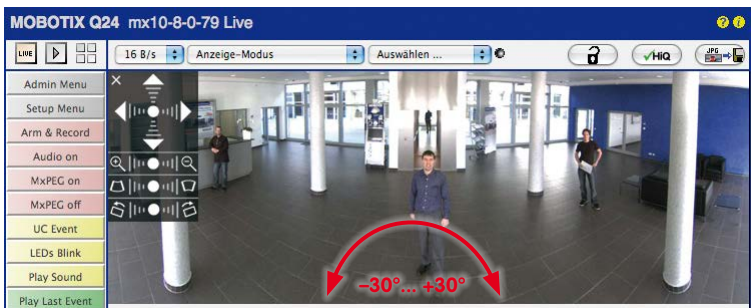
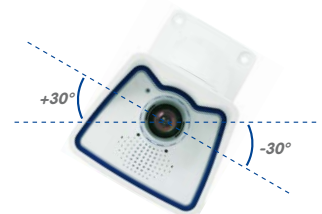

2.5.3 Exchanging the Lens

The M25 can be shipped from the factory with seven MOBOTIX standard lenses (B036, B041, B061, B079, B119, B237, B500) with the CSVario lens or the hemispheric B016 lens. This procedure applies equally for all lenses.

Only lenses with CS or C mounts may be used with the CSVario version of the M25. MOBOTIX lenses with M14 thread cannot be used. Similarly, the standard versions of the M25 can only take the standard MOBOTIX lenses with M14 thread. The hemispheric B016 lens, C Mount and CS Mount lenses cannot be used. Upgrading to other model versions is not possible.

Proceed as follows to change a lens:

1. Unmount the **lens cover** by turning it counter-clockwise.



2. Remove the **lens** by turning it counter-clockwise.



3. **Screw the new lens** (if present) back into the camera and restore the **power supply** of the camera.

4. **Adjust the image sharpness** according to the camera's live image on the computer monitor. Make sure that you do not screw in the lens too far or by using excessive force, since doing so may damage the lens mount.

5. **Screw the lens cover onto the lens again** and clean it, if required, using a clean, lint-free cotton cloth.



The white ring in the lens cover prevents the camera LEDs from adding light reflections to images

The focusing aid provides a visual aid when setting the image sharpness of a MOBOTIX camera lens (see Section 4.3.3, «Image and Audio Settings, Quick Controls» in the Software Manual).

2.6 Replacing the MicroSD Card

The camera must be taken down to remove, insert or replace a MicroSD card. To avoid data loss, be sure to deactivate MicroSD card recording in the camera software and reboot the MOBOTIX camera before removing the card.

Caution

A MicroSD card may only be removed from the camera after you have deactivated Recording to SD Card and rebooted the camera. Failing to do so may lead to loss of data! Make sure that the card is not write-protected!

2.6.1 Removing the MicroSD Card

1. **Deactivate recording:** Recording to MicroSD card must be deactivated (**Admin Menu > Storage on External File Server / Flash Device**). If MicroSD card recording is still active, deactivate recording and reboot the camera. *Section 3.4, «MicroSD Card Recording», contains more information on this topic.*
2. **Remove camera from the weatherproof housing:** Remove the two lock screws from the weatherproof housing and then remove the camera from the housing. In doing so, do not pull too hard on the lens cover. If required, use the long side of the 5 mm Allen wrench to carefully push the camera out of the housing from behind through the screw holes.
3. **Remove the connection cables:** The connected cables (patch cable, MiniUSB) must be removed from the camera first by rotating and opening the bayonet catch (MxBus see *Section 2.7.6*).
4. **Remove the back of the camera and take out the MicroSD card:** Remove the four screws from the back plate using the supplied 2.5 mm Allen wrench and carefully lift off the back plate. Gently push on the MicroSD card in the card slot of the camera. The card is released from the slot and can be removed from the camera.



Bayonet catch open



Push-push operation: only remove the MicroSD card after first gently pushing it in



To use the camera without a MicroSD card, continue by mounting the back plate (see step 2 in *Section 2.6.2*).

2.6.2 Inserting the MicroSD Card

1. **Insert the MicroSD card:** Push the MicroSD card into the card slot as shown, until an audible and perceptible click indicates it is in place.



2. **Mount the back plate:** Replace the back plate of the camera housing, ensuring that the back plate screw holes are correctly positioned above the thread inserts.



3. **Screw the back plate tight and replace the connection cables:** Place the four Allen screws back into the back plate and tighten the screws using the supplied 2.5 mm Allen wrench. The previously removed cables must now be reconnected (see *Section 2.7.5* and *Section 2.7.6*).



Push-push operation:
insert the MicroSD card
and push it in gently



Bayonet catch closed



4. **Attach the camera:** Re-attach the camera to the weatherproof housing using the two lock screws. Make sure that none of the cables are bent or squashed.



5. **Activate recording:** If you have inserted a MicroSD card that has already been MxFFS formatted, you can activate recording under **Admin Menu > Storage on External File Server / Flash Device**. Once the camera has been rebooted, it automatically activates recording.
6. **If you have inserted a new MicroSD card**, it must first be formatted as described in *Section 3.4, «MicroSD Card Recording»*.

2.7 Network and Power Connection

2.7.1 Notes on Cable Lengths and Power Supply

- Power is supplied to the camera via the camera Ethernet connection (patch or installation cable). We recommend using a MOBOTIX PoE adapter or another similar high-quality PoE product to loop-in the power supply:
 - **One camera:** with the PoE adapter (MX-NPA-PoE or MX-NPA-Box)
 - **Multiple cameras:** with PoE products conforming to IEEE 802.3af (PoE switch)
- The **maximum length** of the network cable for power supply over an Ethernet cable is **100 m**.
- Make sure that you only use switches or routers that support the **10/100 Mbps network interface** of the camera.
- We highly recommend using uninterruptible power supplies (UPS) to provide backup power.
- If you are using IEEE 802.3af or IEEE 802.3at (PoE+) Power-over-Ethernet network components to supply power to MOBOTIX cameras, make sure, if possible, that these components do not have a fan. Since the power consumption of MOBOTIX cameras is very low compared to other products, the reliability of the entire system is increased, thus extending the life of these components.

Caution

Appliances with a maximum total power consumption of four watts may be connected to the MxBus connector **and** USB connector **if power is supplied to the camera using PoE class 3**. If **PoE Class 2** is used, **the power consumption of all the connected appliances should not exceed one watt!**

For information on changing the PoE class, see *Section 2.7.8, «Variable PoE»*.

Connection of additional devices with more than 1 W (via MxBus/USB):
Max. ambient temperature +50°C/+122°F!

2.7.2 Network Cabling For M25 With Patch Cables

Using a patch cable and an MX-Overvoltage-Protection-Box or MX-NPA-Box offers the following advantages:

- Quick installation/deinstallation
- No shortening of cable even when installing/deinstalling several times
- Hose-proof/dust-proof connection in accordance with IP66
- Additional protection against overvoltages of up to 4 kV when using the MX-Overvoltage-Protection-Box.

Connecting the Patch Cable to an MX-Overvoltage-Protection-Box, an MX-NPA-Box or a Standard Network Outlet

To establish the network connection of the camera using an MX-Overvoltage-Protection-Box or an MX-NPA-Box, remove the blue bayonet catch and the blue sealing plug from the right-hand side of the box. Insert the MOBOTIX patch cable into the box and fasten the cable using the blue bayonet catch.

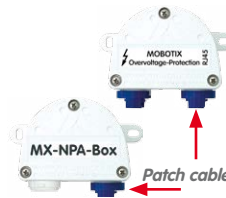

For additional, information on how to install an **MX-Overvoltage-Protection-Box** or an **MX-NPA-Box**, open the **Products > Accessories > Interface Boxes** section on www.mobotix.com.

When using a standard network outlet (only for indoor installations), insert the MOBOTIX patch cable of the M25 directly into the network outlet.

If additional cables are required inside the housing, they must be connected as described in Section 2.7.6, «Connecting a USB Cable» and Section 2.7.7, «Connecting a Two-Wire MxBus Cable».

2.7.3 Power Supply Using a Switch

1. Connect the factory pre-installed cable of the camera to the **camera** connector of the PoE adapter.
2. Connect the **LAN/Power** connector of the PoE adapter to the Ethernet connector of the switch/router or the Ethernet port.
3. Plug the RJ45 connector of the power supply unit into the **PC/Power** connector of the PoE adapter.

IP addresses in the figure are shown only as an example



For the M25 you should use the blue MX-NPA-PoE-Set or the MX-NPA-Box - previous MOBOTIX network power accessories, such as the NPA-Set, Power-Box and Power-Rack (MX-NPA-Set, MX-NPR-4 and MX-NPR8/20) are not suitable for use with the M25



IP addresses in the figure are shown only as an example

The PoE adapter replaces the crossover cable when directly connecting to a computer

For the M25 you should use the blue **MX-NPA-PoE-Set** or the **MX-NPA-Box** – previous **MOBOTIX** network power accessories, such as the **NPA-Set**, **Power-Box** and **Power-Rack (MX-NPA-Set, MX-NPR-4 and MX-NPR8/20)** are not suitable for use with the M25!



IP addresses in the figure are shown only as an example

2.7.4 Power Supply When Connected Directly to a Computer

1. Connect the factory pre-installed cable of the camera to the **camera** connector of the PoE adapter.
2. Connect the **PC/Power** connector of the PoE adapter to the Ethernet port of the computer.
3. Plug the RJ45 connector of the power supply unit into the **LAN/Power** connector of the PoE adapter.

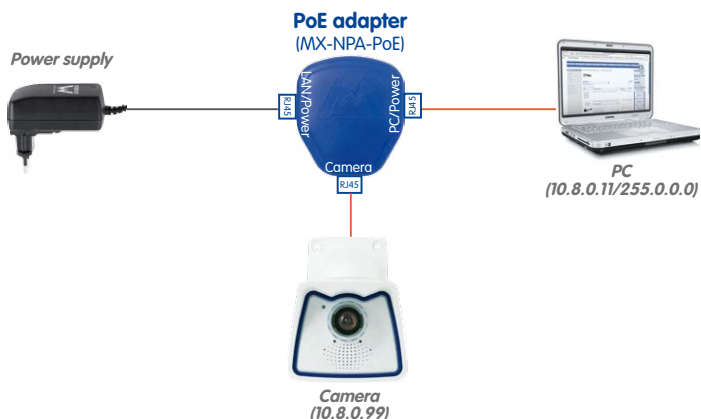

2.7.5 Power Supply with Power-Over-Ethernet Products

Connect the factory pre-installed cable of the camera to a PoE port of the PoE switch/router. The switch/router must support the PoE standards IEEE 802.3af or IEEE 802.3at.

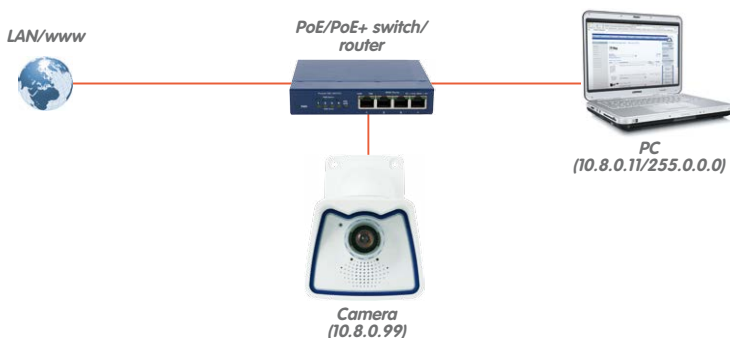

2.7.6 Connecting a USB Cable

Using the USB plug (red circle in figure), you can attach existing expansion modules, such as the MOBOTIX ExtIO (USB), the MX-232-IO-Box or external USB hard drives to the camera in a weatherproof and well-protected manner.



Only use USB cables with **angled plugs** for connecting USB cables to the M25!

Procedure

1. In case the camera had already been installed, remove the camera so you can access the connectors on the back.



2. **Remove bayonet catch and USB plug:** Turn the bayonet catch to the left (red arrow in figure), take it off and remove the blue USB plug.



3. **Insert USB plug:** Push the MOBOTIX cable with the angled MiniUSB plug into the connector (red circle in figure).

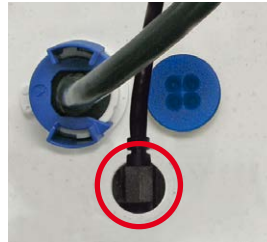

4. **Attach bayonet catch:** Again attach bayonet catch and turn it clockwise until it gently snaps shut (see figure).

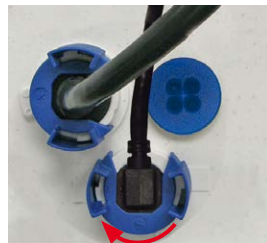

The length of the entire MxBus wiring must not exceed 50 m/55 yd.

2.7.7 Connecting a Two-Wire MxBus Cable

You can use such a cable to connect additional MOBOTIX modules (e.g., the MX-GPS-Box or the MX-232-IO-Box) to the M25.

Note that you can attach two MxBus cables (each having two wires) to the MxBus connector (red circle in figure). Take care not to switch the polarity of the wires. It is recommended to use the same wire color for +/- for the entire MxBus system (e.g., red = +, blue = -).



Procedure

1. In case the camera had already been installed, remove the camera so you can access the connectors on the back.

2. **Prepare MxBus cable:** Remove the blue single wire plug. Strip 5 mm (1/5 in) of insulation from the wire ends of the MxBus cable, then push each wire into one of the four holes in the single wire plug (this prevents humidity from entering the camera).

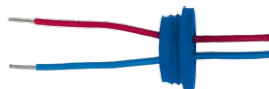

3. **Connect MxBus cable:** Push back the blue single wire plug so that you can easily attach the MxBus cable. Attach the MxBus wires by firmly pushing the wires into the corresponding connectors.



If you need to remove one of the wires, unlock the connector by pressing on the orange-colored area using a small screwdriver, then pull out the wire.



4. **Close the MxBus connector:** Carefully press the single wire plug into the connector socket and twist the MxBus wire pairs.



Single-wire plug



MxBus connector

2.7.8 Variable PoE

The power consumption of the camera depends on the functions in use as well as any peripheral devices connected (see table). PoE classes 1, 2 or 3 may be selected in the browser-based user interface in order to optimally adjust the camera to your system design (PoE switch in use, emergency power concept, etc.).

PoE Power Level Classes (IEEE 802.3af Standard)		
Class	Max. power consumption	Camera operating mode and peripheral devices
1	0.44 W–3.84 W	LowPower mode; no peripheral devices (available soon)
2	3.84 W–6.49 W	Normal mode; max. 1 W for MxBus peripheral devices
3	6.49 W–12.95 W	FullPower mode; max. 2.5 W for MxBus peripheral devices (for example, MX-GPS-Box and MX-232-IO-Box to MxBus), max. 4 W for peripheral devices to MxBus and USB interface

Caution

If the total power consumption of the camera and peripheral devices exceeds the power provided by the PoE switch for the specified class, the switch can disconnect the camera from the power supply. ***In this case, the camera will only be accessible again once the peripheral devices have been disconnected from the camera and the camera has been restarted.***

The default setting is usually fine, and nothing needs to be changed. However, the PoE power class must be changed in the browser if a higher or a lower power class is required for your application:

Variable PoE:
Multiple cameras can be operated simultaneously from the same switch

1. Select **Admin Menu > Network Setup > Ethernet Interface** (for experts).
2. Click on **Change** under **Power Supply**.
3. A **Power Wizard** will appear to guide you through the PoE configuration steps.
4. Next, restart the camera: Disconnect the camera from the power supply. Then reconnect it, for example, by disconnecting and then reconnecting the Ethernet cable at the PoE switch.

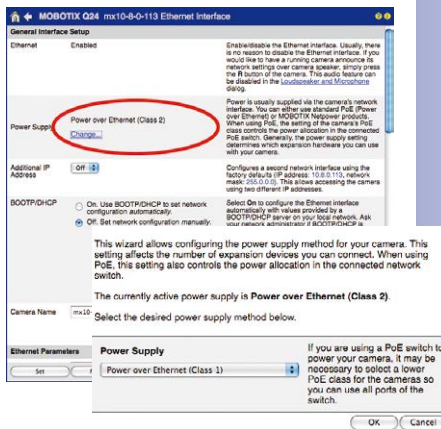

2.7.9 Camera Startup Sequence

As soon as the camera's power supply has been established, the two LEDs will show the progress of the startup sequence (see *Section 5.4.3, «LED Signals and LED Configuration»*, in the *MOBOTIX Camera Software Manual Part 2*).

LED default settings

- 1 Power (on),
Error (flashes)
- 2 Recording (flashes)



1. Booting 

2. Key? 

3. Ready 

- **Booting:** Immediately after connecting the power supply, the red LED lights up, blinks for two seconds, then stays on permanently red. The camera runs a self-test at this point, and starts the entire system after that. In case of an error, the camera will start using the backup system.
- **Waiting for key pressed:** Both LEDs light up for four seconds. If you press the **R or L key of the camera** during this time, the camera will execute the corresponding function (see *Section 3.2.4, «Starting the Camera with Factory (Network) Settings»* and *Section 3.2.5, «Starting the Camera with an Automatic IP Address (DHCP)»*). To press a key, use a **paper clip** for example, but **never use sharp or pointed objects!**
- **Ready:** Once the camera software is running, the green LED is on permanently and the red LED blinks. You can now reach the camera via the network (using a browser, MxManagementCenter, MOBOTIX App, etc.).

Note

During the startup sequence of the camera, the LEDs will always light up, even if they have been deactivated in **Admin Menu > LED Setup**.

3 OPERATING THE CAMERA

3.1 Manual and Automatic Operation – Overview

MOBOTIX cameras do not require any extra software. Thus, you can set up and operate the MOBOTIX camera using a JavaScript-enabled browser on all common operating systems (such as Windows, Linux, Macintosh, etc.). As an alternative, you can also use the MOBOTIX application MxManagementCenter. Follow these steps to set up the camera:

1. Connect the camera to the network.

Power is supplied directly via the Ethernet cable (see *Section 2.7, «Network and Power Connection»*)

2. Establish a connection to the camera and adjust the network settings, if required.

By factory default, MOBOTIX cameras are booting as DHCP client with an additional fixed IP address in the 10.x.x.x range (e.g., 10.16.0.128). Local computer networks usually have IP addresses in the 172 or 192 ranges. Depending on whether a DHCP server is present on the local network (e.g., a DSL router) or if the network has been set up to use fixed IP addresses, there are several possibilities for establishing a connection to the camera and to change its network parameters:

- **Network with DHCP server**

- Using a browser:

- If you know the IP address that the DHCP server assigned to the camera, simply enter that address in the browser address bar to directly connect to the camera (see *Section 3.2.2, «First Images and the Most Important Settings in the Browser»*).

- Using MxManagementCenter:

- With MxManagementCenter, you can show and integrate the camera without having to know its current IP address (see *Section 3.2.3, «First Images and Network Parameter Configuration in MxMC»*).

- **Network with fixed IP addresses**

- In order to access the camera, it must have an IP address within the range of the local network. To set the camera's network parameters, you can use one of these methods:

- Manually using a browser:

- First, you need to change the network parameters of your computer (see *Section 3.2.1, «Manually Setting Up the Network Parameters in a Browser»* and following ...).

- Integration into MxManagementCenter with automatic adjustment of the camera's IP address:

The camera is displayed in MxManagementCenter despite the fact that the IP address is not part of the local network. The application allows reconfiguring the network parameters accordingly (see *Section 3.2.3, «First Images and Network Parameter Configuration in MxMC»*).

3. Configure the camera.

Using the web-based user interface or MxManagementCenter.



Camera software
in the browser

3.2 First Images and the Most Important Settings

Once the MOBOTIX camera has been connected to the network, you need to set up the camera's network interface accordingly. This step involves setting up and checking the network parameters of the camera. If your network has an active DHCP server or is already using an IP address in the 10.x.x.x range with a 255.0.0.0 network mask, you do not need to change the camera's network parameters. You can access the camera directly (see *Section 3.2.2*). If your network or computer does not use an IP address in the 10.x.x.x range (for example, in the 192 or 172 ranges), you should follow one of the following methods for changing the camera's network parameters:

- **Manual Setup** (see *Section 3.2.1*)
- **Automatic setup using MxManagementCenter** (see *Section 3.2.3*)

Note

We will use a camera with the factory address 10.8.0.99 in the following examples. Replace this IP address with the IP address of your camera. You will find the IP address of your camera on a small sticker on the camera. Make sure that the IP addresses used in the following examples are not already being used by other devices in the network.

Pressing the "L" key (see *Section 3.2.4*) will prompt the camera to announce its current IP address on the camera speaker

3.2.1 Manually Setting Up the Network Parameters in a Browser

You need a computer that is using a 10.x.x.x IP address in order to manually set up the network parameters of the MOBOTIX camera. The computer's network parameters usually have to be changed for this purpose.

1. Change the network parameters of your computer:

Windows (XP, Vista and 7):

1. Open **Start > Settings > Control Panel > Network Connections**. Clicking on **Properties** opens the dialog box shown.
2. Double-click on **Internet Protocol (TCP/IP)**. On the **General** tab, activate the *Use the following IP address* option. Enter an IP address in the 10.x.x.x range in this field (for example, 10.8.0.11).
3. Once all dialog boxes have been closed, the computer will have the IP address 10.8.0.11.

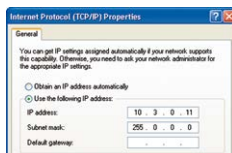
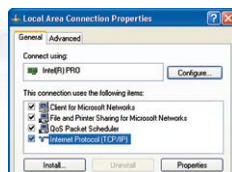

Entry in "Subnet mask" field: 255.0.0.0

Windows 8.1:

1. Open **Start > Settings > Control Panel > Network Connections**. Clicking on **Properties** opens the dialog box shown.
2. Double-click on **Internet Protocol (TCP/IP)**. On the **General** tab, activate the **Use the following IP address** option. Enter an IP address in the 10.x.x.x range in this field (for example, 10.8.0.11).
3. Once all dialog boxes have been closed, the computer will have the IP address 10.8.0.11.

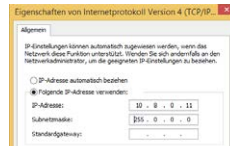
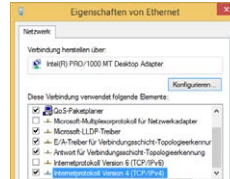

Entry in "Subnet mask" field: 255.0.0.0

Linux/Unix:

1. Open a terminal as `root` user.
2. Enter the following command: `ifconfig eth0:1 10.8.0.11`
3. The computer is now also using the IP address 10.8.0.11

Mac OS X:

1. Open **System Properties > Network**.
2. Select **Ethernet**. In the **Configuration** field, select **Manual** and enter a 10.x.x.x IP address (for example, 10.8.0.11).
3. Click on **Apply** on the bottom right-hand side of the dialog box to assign the computer the IP address 10.8.0.11.

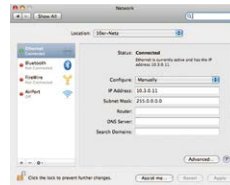

2. Set Up the Target Network Parameters of the MOBOTIX Camera:

1. Open a web browser on the computer and enter the default IP address of the MOBOTIX camera in the address bar of the browser (for example, 10.8.0.99). Pressing Enter displays the user interface of the MOBOTIX camera (see also *Section 3.2.2, «First Images and the Most Important Settings in the Browser»*).
2. Click on the **Admin Menu** softbutton in the user interface of the MOBOTIX camera. The Quick Installation starts automatically once the *admin* user has logged on.

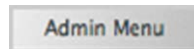

Default user data

User name: **admin**
password: **meinsm**

Note: The Quick Installation can also be executed at a later stage by opening **Admin Menu > Network Setup > Quick Installation** (see also *Quick Installation* in the *Camera Software Manual Part 2*).

3. Enter the target network parameters of the camera on the appropriate page of the Quick Installation assistant.

Note: The network parameters can also be modified retrospectively via **Admin Menu > Network Configuration > Quick Installation**.

4. Once you have completed the Quick Installation and rebooted the camera, the new network parameters will be activated. The camera can now be connected to the target network and, if required, further configured.

The screenshot shows a window titled "Quick Installation" with a subtitle "Camera WebInterface". The main text reads: "Assign a unique IP address and the network mask to the camera. These values consist of four numbers (0 to 255) separated by dots. They define which other IP addresses can be reached directly on your LAN. In order to access the camera from your computer via LAN, your computer needs an IP address on the same subnet as the camera." Below this, a note says: "If unsure, ask your system administrator for a valid and unique IP address and the network mask of your subnet." At the bottom, there are two input fields: "Camera IP Address: 192.168." and "Camera Network Mask: 255.255.0.0".

3.2.2 First Images and the Most Important Settings in the Browser

Once the MOBOTIX camera has been connected to the power supply and to the network, you can access the user interface with the live camera image in the web browser. Internet Explorer, Firefox, Safari or any other graphical browser with activated JavaScript is suitable. It does not matter which operating system is used.

After entering the camera's IP address in the browser's address bar, you will see the live view of the MOBOTIX camera with its user interface controls, such as softbuttons, buttons for the different camera screens, pull-down menus (Quick Controls), icons for accessing the online help and the camera status, and status information elements.

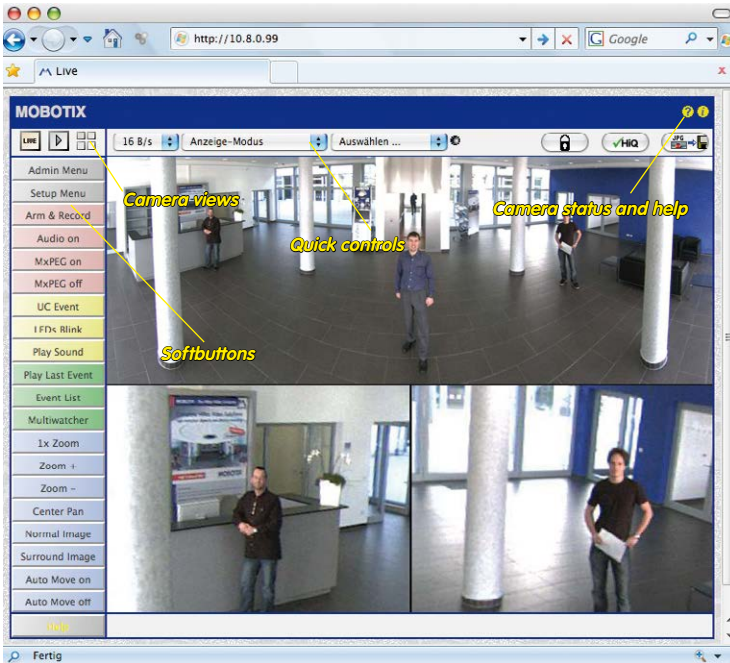

Note

Default access data for the administration menu

- User name: **admin**
- Password: **meinsm**



Live view:
<http://<camera IP>/control/userimage.html>

Camera Views: Live, Player, MultiView

The MOBOTIX camera automatically displays the **live** screen when it starts up (factory default setting). You can set a different start page in **Admin Menu > Language and Start Page** (for example, the **Guest** screen) to allow a restricted access to the live image.

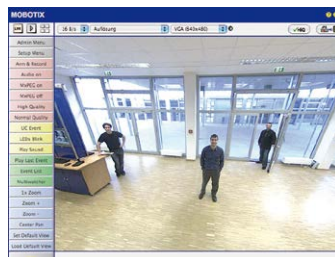

Player screen:
<http://<camera IP>/control/player>

The other available standard screens include **Player** (playback of recorded images and video sequences) and the **MultiView** screen (displays several cameras with live or recorded images).



MultiView screen:
<http://<camera IP>/control/multiview>

MultiView allows you to view several cameras via a “proxy” camera (especially useful if you want to access your cameras from outside of the network with reduced bandwidth) and the **PDA** mode provides a special screen for mobile devices.

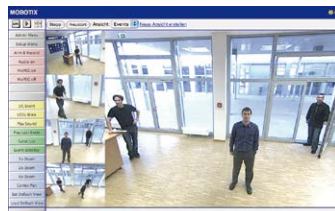

PDA screen:
<http://<camera IP>/pda>

PDA event list:
<http://<camera IP>/control/player?eventlist&pda>

Guest screen:
<http://<camera IP>/cgi-bin/guestimage.html>

Note

For more information on camera screens, see *Section «Camera Screens In The Browser»* in the *Camera Software Manual Part 2* or the online help of the camera’s user interface.



3.2.3 First Images and Network Parameter Configuration in MxMC

Installing and Starting MxManagementCenter

Download the current version of MxManagementCenter from the MOBOTIX website (www.mobotix.com > **Support** > **Software Downloads** in the **MxManagementCenter** area). Double-click the shortcut for the program or the program file.

Finding Cameras

When starting MxManagementCenter for the first time, the configuration wizard opens and automatically starts searching for MOBOTIX cameras. The number of found cameras is shown next to the Add button. This number is updated automatically if the number of MOBOTIX cameras on the network has changed (i.e., by connecting new/disconnecting existing cameras)..

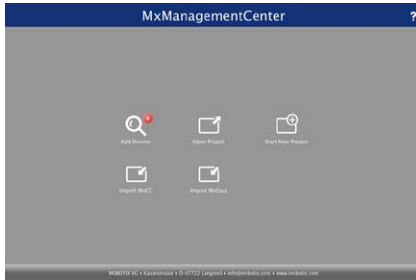

Download MxManagementCenter for free from www.mobotix.com

Click on **Add Devices**. The cameras are displayed either in a list or as tiles. Use the **List** and **Tile** buttons to change the display mode.



MxManagementCenter automatically monitors and displays the operating status of all cameras. Cameras that are not on the same subnet as the computer are indicated by the icon (Camera not in the same network as the computer). Likewise, the cameras

that have an unknown password or for which no user name/password combination has been specified in MxManagementCenter will be displayed with the icon  (Camera is password-protected).

Reconfiguring Network Addresses of Cameras

Using Bonjour*, MxManagementCenter finds not only cameras on the same network as your computer, but also MOBOTIX cameras located in other subnets (status: ). In such a case, you would not be able to establish any connection to cameras in a different network or subnet.

This is the case, for example, if you are integrating cameras into a network without DHCP server (i.e., with fixed IP addresses) and the IP address range is different from the 10.x.x.x range supported by the cameras in addition to DHCP.

MxManagementCenter can automatically configure such a camera so that it is "integrated" into your existing network. To do so, you have to select the respective camera and then click on the  button at the bottom of the program window.

The **Network Setting** dialogue opens.

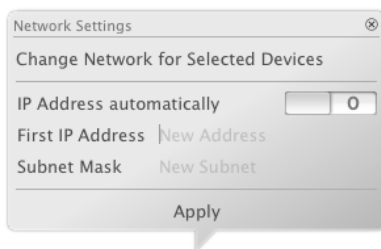

If you have assigned a fixed IP address to your computer, you will certainly prefer to assign fixed IP addresses to the cameras. To do so, enter the IP address and the subnet mask. The IP address is incremented automatically for each selected camera.

When you click on **Apply**, the selected cameras are automatically reconfigured and they are located in the same subnet as the computer.

Adding Cameras

After a camera has been reconfigured, it has the status **Accessible** and can be integrated into MxManagementCenter.

Select the desired cameras (use **Cmd-click** to select several cameras). If the cameras are password-protected **1**, click on **Edit User and Password** **2** and enter the user name and password.

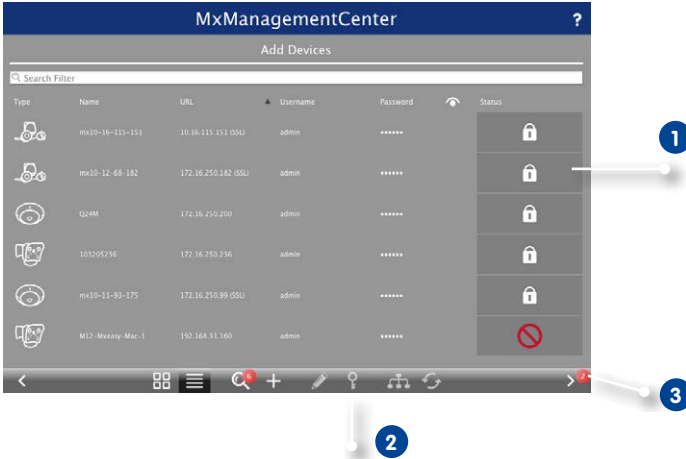

The number of selected cameras is shown on the **Next** button **3**. Move to the next page and click on **Finish**.

For more information, see the **MxManagementCenter Tutorial**, which can be downloaded as a PDF file from the MOBOTIX website: www.mobotix.com > **Support** > **Tutorials**.

3.2.4 Starting the Camera with Factory (Network) Settings

In certain situations, it may become necessary to start the camera with its default settings for the network (DHCP client and additional 10.x.x.x IP address) and for the other parameters. This could be the case, for example, if the IP address has been lost or the camera cannot be accessed using the last known IP address. In order to start the camera with the factory default settings for all parameters (with the exception of users and passwords), proceed as follows:

1. If the camera is powered on, disconnect the power supply by unplugging the corresponding cables and then reconnect the power supply.
2. Wait until both LEDs light up simultaneously for the first time.
3. **Press the L key within the next four seconds and hold it down** (if you need to try again, go back to Step 1). Use a **paper clip** for this purpose but **avoid using sharp or pointed objects!**

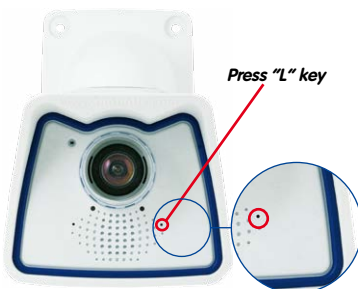

4. **After about 30 to 45 seconds**, the camera emits a single sound (“boing”).

The camera has finished booting and can now be used (e.g., MxManagementCenter, MOBOTIX App, web browser).

Notes

If you use the camera's **L key** to load the factory configuration, this configuration is not automatically saved in the camera's flash memory. When the camera is next rebooted without using the **L key**, the last stored configuration will be used. To permanently store the new configuration in the camera's flash memory, open **Admin Menu > Store**. Note that you can restore specific parts of the camera configuration afterwards by using “Restore” to re-apply the settings still stored in the camera.

As opposed to resetting the camera using **Admin Menu > Reset configuration to factory defaults**, the user information will **not** be reset if the camera is booted using the factory settings.

Make sure you store the default network configuration to the permanent flash memory

3.2.5 Starting the Camera with an Automatic IP Address (DHCP)

If a DHCP server is active on the network, you can also boot the camera with the DHCP client (factory default), without having to reset the entire configuration to the factory default settings. The camera will then automatically get an IP address from the DHCP server and will announce the new network parameters. Note that this is only possible if the speaker has been activated for this camera.

1. If the camera is powered on, disconnect the power supply by unplugging the corresponding cables and then reconnect the power supply.
2. Wait until both LEDs light up simultaneously for the first time.
3. **Press the R key within the next four seconds and hold it down** (if you need to try again, go back to Step 1). Use a **paper clip** for this purpose but **avoid using sharp or pointed objects!**



4. **After about 30 to 45 seconds**, the camera emits a double sound (“boing boing”).

The camera has finished booting and can now be used (e.g., MxManagementCenter, MOBOTIX App, web browser).

Notes

Starting the camera with an automatic IP address (DHCP) is only **temporary**. The network configuration of the camera can be permanently set to DHCP (factory setting) under **Admin Menu > Ethernet Interface**.

Make sure that the network has a functioning DHCP server when starting the camera with DHCP support. If this is not the case, the camera cannot obtain a valid IP address and will use its last IP address.

You should also make sure that the cameras always obtain the same IP addresses by permanently assigning the MAC addresses of the cameras to the desired IP addresses.

In case of an error, the camera uses its last IP address

3.3 Virtual PTZ and Full Image Recording

3.3.1 Preparing the Virtual PTZ Function

The virtual PTZ function allows you to use a mouse or joystick to continuously zoom in on images from the selected video source and “virtually” move the enlarged image section within the entire image sensor area.



Greater ease of use
through a joystick



Operation Using The Mouse And Scroll Wheel

The vPTZ function of the M25 can be controlled in the browser using the mouse. This position becomes the new image center by clicking on any position on the image displayed on the monitor. The image moves accordingly and the image distortion is automatically corrected. The **scroll wheel** can be used to control the zoom function. This functionality is disabled in the default settings of the camera and must therefore first be activated. To do this, go to **Setup Menu > vPTZ Settings**, disable **Lock Mouse Wheel Zoom**, click on **Set** and then on **Close** to save your settings. You can now use the scroll wheel to zoom + (roll upwards) or zoom - (roll downwards).

Operation Using USB Joystick

A standard USB joystick can drastically improve vPTZ operation for the user – in the browser and in MxManagementCenter. Please first install the joystick on the PC according to the manufacturer’s instructions.

In order to use a USB joystick in the browser, make sure that you have a PC with a Windows operating system and the latest version of Internet Explorer and that the **“ActiveX” mode in the camera software (browser) is activated:**

- Switch to **Browser** in the Quick Control.
- Under **Browser**, select the option **ActiveX** in the field to the right. The USB joystick can then be used until the browser is closed.
- To store the setting permanently, ActiveX must be activated in the **Admin Menu**. To do so, use **Language and Start Page** in the Admin Menu.
- Under the page options, select the **ActiveX** operating mode.
- Store the settings permanently in the camera by clicking on **Set** and **Close**.
- The joystick can now be used.

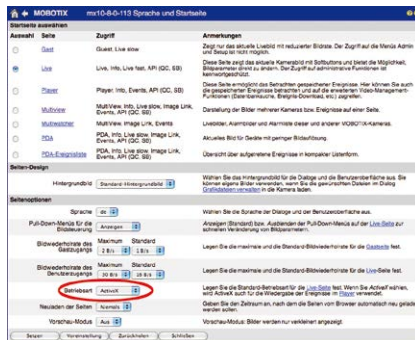
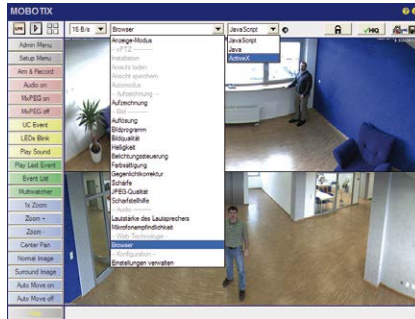

Notes

You will find more information and details on vPTZ in the **Camera Software Manual Part 2, Section 4.3.6, «Virtual PTZ»**.

Current versions of all manuals can be downloaded anytime from the MOBOTIX website www.mobotix.com under **Support > Manuals**.

3.3.2 Full Image Recording

It is possible to record a **full image**, regardless of the live image stream that is being displayed. This ensures that the recording always contains the full image of the lens used, even though the operator may have used the vPTZ features to zoom into the image in order to examine a specific detail.

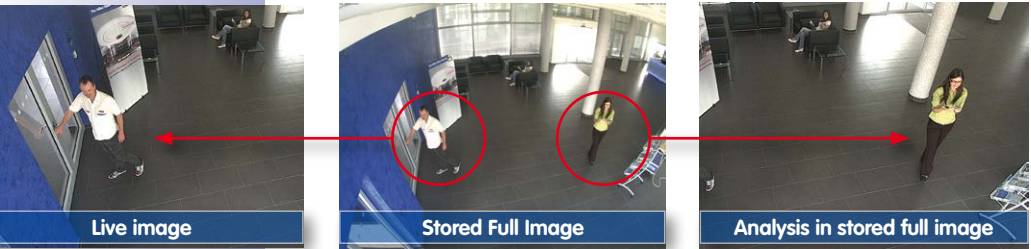

Stored full image:
Original camera image
without distortion or
image correction

This means that you can use the vPTZ features in VGA resolution to pan, tilt and zoom in the live image while the camera is, for example, recording full images at 1 fps in MEGA or 6MP resolution.

In **MxManagementCenter**, the recorded full images may be prepared for the user with the vPTZ functions (for example, panning and zooming in on an image detail such as a doorway).

If **full image recording is not activated**, only the last displayed live image will be saved (save what is seen). The **main benefit** of live image storage is to ensure that the full power of the camera processor is used for live image correction and maximum frame rates. The **main advantage of full image recording** lies in the special functionality of the D14D, in that it can always ensure the availability of a maximum size (full) image for later searches, despite vPTZ actions carried out on the live image. The mechanical limitations of motor-driven PTZ cameras mean that they simply **cannot** provide this unique advantage to the user!

Notes

Post-event search in the full image: If you are using Full Image Recording on D14D cameras, you should use at least MEGA resolution when storing. This will facilitate later searches in **MxManagementCenter**. The advanced distortion correction features require this function to deliver satisfactory image quality.

Full image recording on: Due to the increased processing time, full image recording reduces the data rate of the live image stream, which may drop by around 10 to 30 percent. We therefore recommend reducing the frame rate for storage as much as possible to affect the live image stream as little as possible.

Full image recording off: The event that triggered a video motion (VideoMotion VM) window may not be in the recorded sequences while the window was not displayed at the time.

Activate/Deactivate Full Image Recording in the Browser

To configure this feature, open the **Setup Menu > Event Control > Recording** dialog box and activate or deactivate the **Full Image Recording** option.

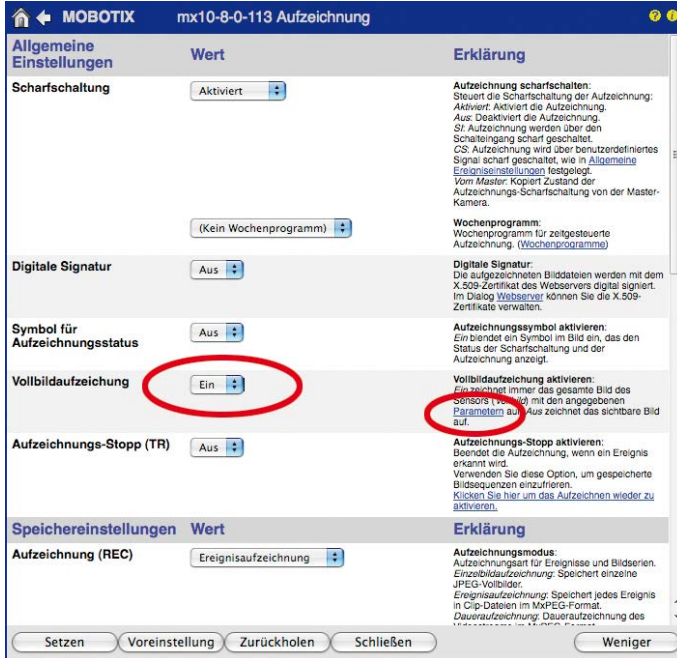

3.3.3 Special M25 Configuration in the Browser

Thanks to its hemispherical lens, the MOBOTIX M25 provides certain special configuration options for the image settings. Depending on where the camera is mounted (ceiling or wall) and on the live image display preferred by the user, certain important basic settings and, if necessary, their adjustment must be configured when a M25 is first installed.

A corresponding adjustment of the image setting is strongly recommended if the on-wall set is mounted with an inclination of 10 degrees (available as a M25 accessory).

Configuration of the M25 Basic Parameters

Complete the steps described below in the browser window:

1. **Log onto the camera and boot it** as described in *Section 3.2*.
2. **Select mounting position wall/ceiling/floor:** Click on **Installation** in the Quick Control panel and then select **Wall**, **Ceiling** or **Floor** according to the mounting position of the camera. **Ceiling** always means that the orientation of the camera or sensor module is from **top to bottom** and for **Floor**, the camera or sensor module's orientation is from **bottom to top**.

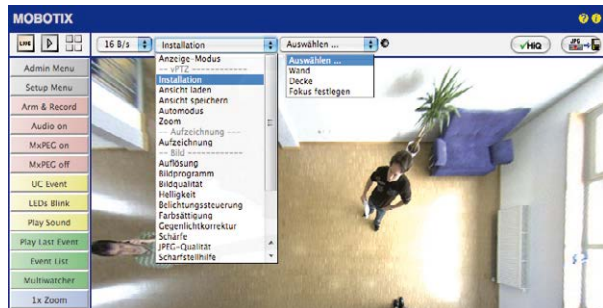

As a result, you will get a **perspective-corrected panorama view** for each image sensor matching the specified mounting position. Panorama view is set as a factory default and it can be changed as described below.

3. Switch to the **Display Mode** Quick Control.
4. Set the mode that you want to be the standard view. For demonstration purposes, the descriptions below describe the typical display mode for the wall mount and the ceiling mount, **Panorama** and **Surround** respectively. Every other display mode can be operated in the same way.

Wall-Mounted: Setting and Correcting the Standard View "Panorama"



High-resolution 180° panorama

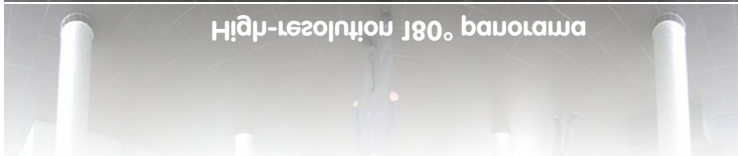

High-resolution 180° panorama

Camera live image with panorama correction

1. In the **Display Mode** Quick Control, select the option **Panorama**. Examine the image that is now displayed. If the section meets your expectations, no further adjustment is necessary, and panorama configuration is complete. To change the image section to meet your specific expectations, continue with Step 2.

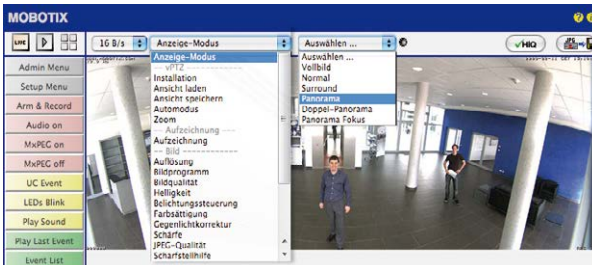

Camera live image without MOBOTIX panorama correction with Quick Controls visible

Note

The currently visible image section may differ from the desired image section due to the installation position or any accessories in use, for example. However, it is not necessary to physically move the camera, as in this case the browser alone can be used to adjust the visible panorama image by zooming, panning and tilting. Tilted vertical lines may also be optically straightened to the image edges using the panorama correction function. These tilted lines are primarily caused if the camera or sensor module is tilted (for example, due to mounting with 15° wedges) or if the image tilt is modified.

- Click on the **lock icon**. Clicking on the lock once opens it (lock clasp is raised). The lock prevents execution of later vPTZ actions, which could also unintentionally modify the view you configure. This holds for all overview display modes, that is, also for Panorama/Focus, Double Panorama and Surround.



Open lock



- A new **icon for processing the panorama image** appears in the top left corner of the camera image. Enlarge the image by clicking on the icon once (OnScreen Control appears).



Click on the icon



- Using the **OnScreen Control** visible in the live camera image, you can now change the displayed live camera image as desired (panning, tilting, zooming, rotating and panorama correction; see fig. on the right). When doing so, the vPTZ function using the mouse or joystick is deactivated.



Camera live image with
panorama correction with
OnScreen Control visible

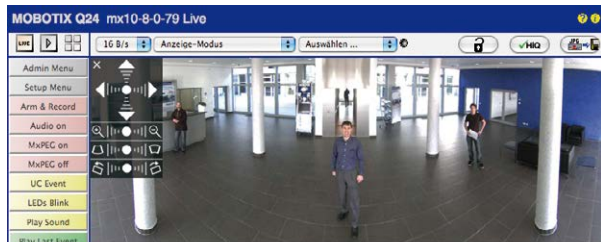

- After you have modified the desired setting, close the control panel (x in the top left hand corner).
- Click on the lock icon again** to close it (lock clasp is down). The panorama image setting is then locked until the camera is next restarted.

Caution

To permanently save the standard image setting defined for the M25, go to the **Store Complete Configuration** option in the **Manage Settings** Quick Control. The settings will then remain in effect, even after rebooting.

Functions of the M25 OnScreen Control

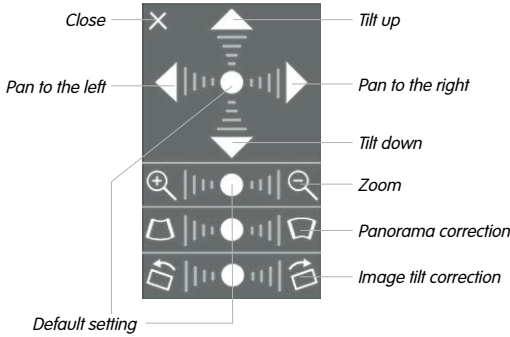

To use the OnScreen Control, click on the arrows in the top area for shifting the image section. In the bottom areas, which are displayed when needed, click to the left and/or right of the center point.

The same applies for every area: **The further away that you click from an area's center point, the greater the change triggered.** To reset an area, click on its center point again.

During panorama correction, clicking between the two trapezoid symbols straightens the left or right tilting lines, which are best visible at the edges of the image section.



Depending on the mounting position (ceiling, wall, floor), panorama correction and mounting error correction may not be available!

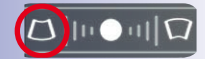

Bring columns together at the top (necessary to correct the example on the left)



Bring columns together at the bottom

Ceiling-Mounted: Set North (User-Defined North Direction)

Once the camera has been mounted on to the ceiling, you need to specify its North direction. This is not the “true” direction of North but rather the **main line of sight or the focus** of the camera or sensor module. It serves as a reference for the North direction in the **Surround** and **Double Panorama** display modes (the **Ceiling** option was already selected in the **Installation Type** Quick Control).

1. In the case of a double image, click on the corresponding sensor module (camera image) and select the **Normal** option from the **Display Mode** Quick Control.



2. **Rotate the live image** in the desired direction using the mouse or a joystick connected to the computer.



For vPTZ use and the configuration of a USB joystick, see Section 3.3.1

- In the **Installation Quick Control**, select the **Set North** option.

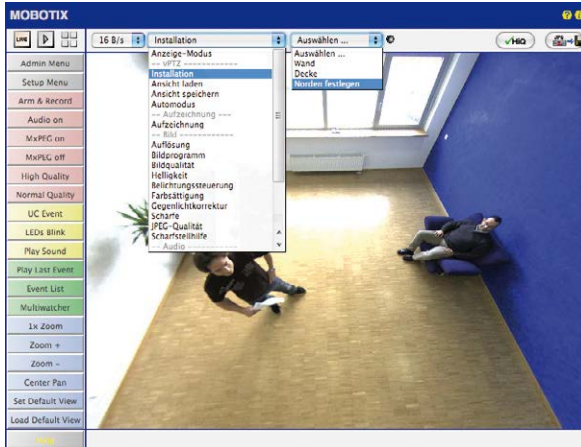

- Store the desired North direction permanently by first activating the checkbox and then clicking on **Yes**.

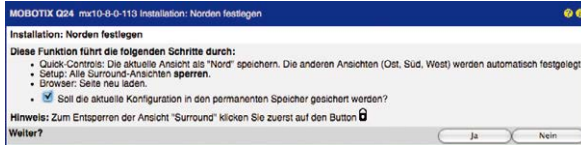

- You have now set the North direction for the **Surround** and **Double Panorama** display modes. In the next step, you can set these views as the standard view for the camera live image.



Caution: No OnScreen Control is available in "Double Panorama" mode



In the **Display Mode** Quick Control, select the option **Surround** or **Double Panorama**. You can fine-tune the views using the vPTZ via mouse or joystick and, as described above, by unlocking and locking the standard view using the lock icon (open lock, correct display and close lock again).

Note

For each of the **subviews** (*North, East, etc.*), the **OnScreen Control** on the side can be used to adapt it (open lock, click on subview, adapt view, click on next subview, adapt view and close lock again).



3.4 MicroSD Card Recording

3.4.1 Introduction

Flash-based storage devices (MicroSD cards, USB sticks and solid-state drives) do not contain any moving parts as compared to the commonly used hard drives. Flash-based storage devices are compact and highly resistant to moisture and vibrations. They feature low energy consumption and they do not lose any data in the event of a power failure, meaning that they are ideal for use with MOBOTIX cameras.



Flash memory devices: more robust than hard drives

Number of Write/Delete Cycles Per Flash Storage Cell

The number of write/delete cycles of every storage cell of a flash device is limited. The controller of the flash device automatically detects individual flash cells that are no longer functioning. The contents of the faulty cell will then be rebuilt using a checksum and will be moved to a properly working spare cell. The faulty storage cell will be marked as “bad” and will no longer be used. No data is lost in this process.

In addition, MOBOTIX cameras constantly monitor activated flash storage devices. MOBOTIX has developed a technology to test the wear of the flash device by logging the number of write/delete cycles (patent pending). The flash memory wear is automatically displayed in the status bar in the live camera image but it can also be viewed at any time in the **Admin Menu > Camera Status** dialog box.

Conservative Memory Usage Thanks to MOBOTIX MxFFS File System

MxFFS formatting of the MicroSD card means that MOBOTIX camera software will use the flash device as evenly as possible, thus allowing for the maximum possible number of write/delete cycles. This also means that all storage cells of the flash device will be written and deleted with the same frequency, if possible. MOBOTIX technology increases the life of the flash device considerably and also improves the security and the reliability of the storage process.

Storage Requirements and Life Expectancy of MicroSD Cards

The life expectancy of a MicroSD card increases proportionally to the storage capacity, since the camera software will execute fewer write/delete cycles on each storage cell. The first deletion will begin once the SD card has been filled to capacity (first full cycle).

All specifications are based on calculated averages

32 GB MicroSD Card: Storage Requirements					
	6 fps CIF	6 fps VGA		1 fps MEGA	1 fps QXGA
	M-JPEG	M-JPEG	MxPEG	M-JPEG	M-JPEG
File size single image	15 kB	45 kB	–	120 kB	240 kB
Storage required per second	90 kB	270 kB	75 kB	120 kB	240 kB
Storage required per 24 hrs	7.8 GB	23.5 GB	6.5 GB	10.4 GB	20.8 GB
Time for one full cycle	4 days	1.3 days	4.8 days	3 days	1.5 days

4 GB MicroSD Card: Storage Requirements					
	6 fps CIF	6 fps VGA		1 fps MEGA	1 fps QXGA
	M-JPEG	M-JPEG	MxPEG	M-JPEG	M-JPEG
File size single image	15 kB	45 kB	–	120 kB	240 kB
Storage required per second	90 kB	270 kB	75 kB	120 kB	240 kB
Storage required per 24 hrs	7.8 GB	23.5 GB	6.5 GB	10.4 GB	20.8 GB
Time for one full cycle	12 hours	4 hours	14.4 hours	9.2 hours	4.4 hours

Caution

The MicroSD card's service life depends on production quality and frequency of use. Set the type of recording (event-controlled or continuous recording, frame rate, resolution) according to your specific requirements.

We recommend changing the pre-installed, high-quality MicroSD card once a year if you have it constantly set to continuous recording.

Monitoring The Cell Wear Of Flash Storage Devices (Patent Pending)

MOBOTIX uses its own technology for this purpose and has a pending patent. You can view the flash wear in the status bar of the live image or by opening **Admin Menu > Camera Status**. In addition, the camera can also send a warning message (for example, via e-mail) as soon as a critical error is detected when data is written to the SD card (**Admin Menu > Error Notification Function**.). The MicroSD card can then be replaced to ensure that any existing data is not lost.

File Server / Flash Device	
Type	SD Flash Card
File System	MxFFS
Flash Wear	1%
Transfer Buffer Usage	0% (0: 0%, max: 0%)
Lost Event Images	0
Sequences	1 (1 files)
Newest Sequence	1970-01-01 01:00:00 #0
Oldest Sequence	1970-01-01 01:00:00 #0
Current Usage	4.0 MBytes (0.4%)
Max. Size	936 MBytes

3.4.2 Formatting the MicroSD Card

Before a MOBOTIX camera can store image and video sequences on a MicroSD card, the card needs to be formatted as MxFFS (MicroSD cards supplied by MOBOTIX are already MxFFS-formatted). The following steps are necessary to format a storage device (Admin Menu > Storage on External File Server / Flash Device):

- 1. Make sure that there is a MicroSD card in the card slot of the MOBOTIX camera.
- 2. Click **Format** in the **SD Memory Card** line.



- 3. Note down the characters shown in the **Encryption password** field or enter your own password. Next, click **OK**.

Note: The **Secure deletion – Slow** option will ensure that any data on the MicroSD card is overwritten completely so that the data cannot be recovered in any way. However, keep in mind that this kind of safe formatting takes considerably more time.

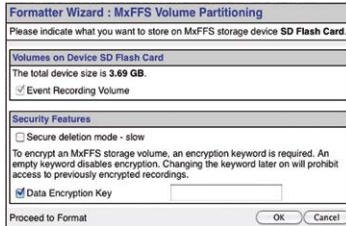

- 4. In the next dialog box, enter the user name and the password of a user of the **admins** group and click **OK** to confirm.

The MOBOTIX camera now starts formatting the card. It takes 5 to 12 minutes to format an 8 GB MicroSD card if the **Secure deletion – Slow** option is disabled. If **Secure deletion – Slow** is enabled, this may take anywhere between 3 and 14 hours.



Once the formatting has been completed, you can activate the MicroSD card for recording (see next section).

Caution

Make sure that you always wait until the formatting process has been completed before accessing the camera again. If the **Secure deletion – Slow** option is disabled, this usually takes just a few minutes. You can only access the MicroSD card once MxFFS formatting has been completed.

Formatting with the **Secure deletion – Slow** option enabled takes several hours. You can also use suitable applications on Windows, Linux/UNIX and Mac OS X systems to repartition and safely erase the MicroSD card.

Format SD card:
Admin Menu > Storage on External File Server / Flash Device

The **Secure deletion – Slow** option takes several hours. You can also use suitable applications on Windows, Linux/UNIX and Mac OS X systems to repartition and safely erase the SD card.

Activate recording:
Admin Menu >
Storage on External File
Server / Flash Device

3.4.3 Activating MicroSD Card Recording

Follow these steps to activate the recording to a MicroSD card that has already been MxFFS-formatted (**Admin Menu > Storage on External File Server / Flash Device**):

1. Make sure that there is a MicroSD card in the card slot of the MOBOTIX camera.
2. Make sure that the MicroSD card is formatted in MxFFS format.
3. Activate the **SD Flash Card** option.
4. Click on **Set** and then **Close** to store the configuration.
5. Reboot the MOBOTIX camera (**Admin Menu > Reboot Camera**).

Once the camera has rebooted, make sure that the camera displays the **FR REC** symbols in its live image. If this is the case, the camera uses the MicroSD card as recording target. If not, you must activate the recording (see below).

Activating the Recording

If the **FR REC** symbols are not visible in the live image after rebooting, you need to activate the recording using one of the following methods in the web browser:

- Automatic activation by clicking on the **Arm & Record** softbutton. Confirm this in the Easy Dialog by clicking on the **Yes** button.
- Manual activation via the Quick Control **Recording > Recording on** or in **Setup Menu > Recording**.

Encryption and Authentication

All video data stored on the MicroSD card is encrypted to ensure security at all times. The password for this is defined during the card's formatting procedure and needs to be entered for authentication whenever the recordings are accessed (see next section).

MicroSD Card Recording

3.4.4 Accessing Data on the MicroSD Card

The following options facilitate access to the stored image and video sequences on a MicroSD card:

- **In the web browser:** Play back the recorded event images without audio directly from the MicroSD card using the Playback view of the camera software.
- **In MxManagementCenter:** Play back the recorded video sequences with audio by accessing the MicroSD card in the MOBOTIX camera via the camera or with a direct access to the MicroSD card via a card reader connected to the computer (coming soon).

Caution

When **using the MicroSD card from one MOBOTIX camera in another MOBOTIX camera**, you need to make sure that the time on the original camera is in sync with the new camera. We recommend using automatic time synchronization via a time server (**Admin Menu > Date and Time**).

3.4.5 Deactivating Card Recording

Follow these steps to deactivate the memory on a MicroSD card (**Admin Menu > Storage on External File Server / Flash Device**):

1. Activate the **None** option.
2. Click on the **Set** button at the bottom of the dialog box and then on **Close**.
3. Reboot the MOBOTIX camera (**Admin Menu > Reboot Camera**).

Once the camera has rebooted, make sure that the symbol **FR REC** is no longer visible in the bottom right-hand corner of the live image. You can now safely remove the MicroSD card from the camera (see *Section 2.6, «Replacing the MicroSD Card»*).

Caution

A **MicroSD card may only be removed from the camera after you have deactivated the recording** to MicroSD card and **rebooted the camera**. **Failing to do so may lead to data loss!**

Removing connected flash storage devices from the camera without properly deactivating them may lead to data loss and/or destroy certain areas of the storage device. This is limited to 4 MB of lost data per incident due to MxFFS formatting.

3.4.6 Using a MicroSD Card in a Different MOBOTIX Camera

A MicroSD card containing recorded video data from a MOBOTIX camera can be inserted into any MicroSD card-enabled MOBOTIX camera. Once a MicroSD card recording has

been activated (requires a reboot), the "new" MOBOTIX camera automatically synchronizes with the card and resumes recording. No data is lost in this process. Make sure that you deactivate MicroSD card recording before removing the card and then reboot the MOBOTIX camera.

If the MicroSD card's contents are encrypted, you need to enter the same password in the "new" camera in the **Admin Menu > Storage on External File Server / Flash Device** dialog box. Otherwise, the camera cannot access the MicroSD card.

3.4.7 Limitations on Warranty When Using Flash Storage Media

MOBOTIX will not assume any responsibility for flash storage devices (for example, MicroSD cards or connected USB storage devices) delivered with or integrated into MOBOTIX cameras. The same applies to damage to flash storage devices or damage resulting from the use of devices that are not supplied by MOBOTIX.

3.5 Configuration in the Browser

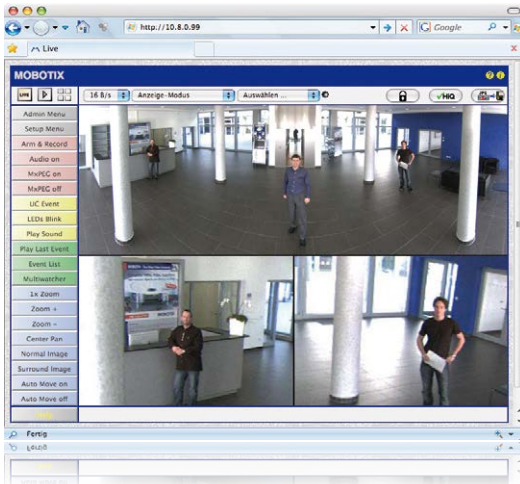

3.5.1 Overview

A MOBOTIX camera can be completely configured using a JavaScript-enabled browser on all common operating systems (such as Windows, Linux, Apple, etc.). The camera provides a HTML-based user interface for this purpose. The camera executes the changes you make to the camera configuration via HTTP commands using programs and scripts of the embedded software. The settings are stored in the camera's flash memory.

This section contains an overview of the basic browser settings of the MOBOTIX camera as well as further configuration options. Detailed information on the software functions is provided in the camera's online help.

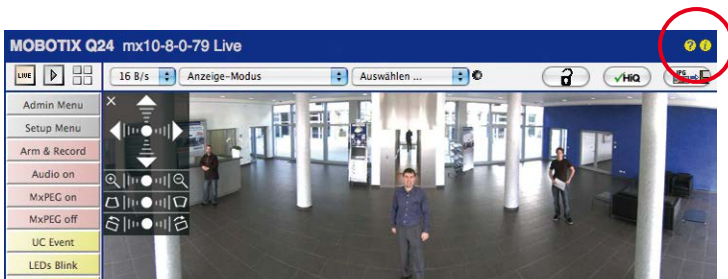

User name: admin
password: meinsm

Admin Menu

Setup Menu

Make sure to permanently store changed parameters!

Automatic time synchronization using a time server

More: Display advanced features

Less: Hide advanced features

Basic Settings

- **Administering the camera:** You can modify the camera configuration in the Admin Menu or the Setup Menu.
 - **Admin Menu:** This menu contains the basic configuration dialog boxes of the camera (for example, passwords, interfaces, software updates).
 - **Setup Menu:** This menu contains the dialog boxes for configuring the image, event and recording parameters. Some of these settings can be changed using the corresponding Quick Controls in the live view.
- **Resetting changes:** If you would like to reset some larger changes in one dialog box without resetting the complete configuration, you can use the **Default** button at the bottom of the dialog box to reset only this dialog box's settings to the factory defaults. If you would like to reset all image settings, you can do so using the **Manage Settings > Restore Image Settings** Quick Control in the live image of the camera.
- **Storing changes permanently:** Once you have finished configuring the camera, you should always store the settings in the camera's permanent memory. You can do so in each dialog box (clicking on the **Set** button at the bottom of each dialog box will temporarily implement the change; when you click **Close**, you will be asked to store the complete configuration in the camera's permanent memory) or in the Admin Menu (**Admin Menu > Store current configuration into flash memory**). The **Configuration** section of the Admin Menu provides more functions for storing, copying and managing camera settings. For more information on this topic, refer to the online help for the specific dialog boxes.
- **Time tasks and time synchronization:** Apart from a multitude of possibilities for controlling the camera using time (time tables, holiday and vacation, scheduled tasks, etc.), the camera can also synchronize its internal clock. This allows you to manually synchronize the camera with a computer or automatically using a time server or another MOBOTIX camera. The camera can use either NTP time servers or Time Protocol servers. For more information on this topic, refer to the online help for the specific dialog boxes.
- **The "More" and "Less" buttons:** When opening some of the camera dialog boxes, the camera only shows the most important parameters. These dialog boxes have a **More** button in the bottom right-hand corner. Click it to display additional options. If all options are displayed, click on the **Less** button to hide the additional options.

3.5.2 General Browser Settings

- **Run the Quick Installation:** After booting a new MOBOTIX camera, accessing the administration menu for the first time will automatically start the Quick Installation assistant (**Admin Menu** button). The Quick Installation assistant helps you in setting the most important parameters of the camera. For security reasons, you should set your own administrator password and disable public access to the camera.
- **Disable public access:** Guest users are only allowed to access the Guest screen of the camera without entering a password. If this is not required, you should deactivate public access (**Admin Menu > Quick Installation** or **Admin Menu > Users and Passwords**).
- **Add users and assign access rights:** Similar to a computer operating system, you can add users and user groups and assign the desired rights (**Admin Menu > Users and Passwords**, **Admin Menu > Group Access Control Lists (ACL)**). This approach allows individual access rights to be assigned or denied to camera-specific features based on the user groups.
- **Deactivate the automatic reboot:** In its factory state, every MOBOTIX camera will automatically reboot at 3:36 a.m. every day. All images in the camera's storage buffer will be deleted during this reboot. Images stored on external file servers, internal flash storage, or SD cards will NOT be affected by this reboot. Make sure that you deactivate the automatic reboot if this is not desired (**Admin Menu > Time Tasks**).
- **Optimize the image settings:** The factory image settings of MOBOTIX cameras deliver excellent images for most application scenarios and should therefore not be changed. If you do wish to make changes, your changes should be minor and gradual. You should, however, set an image program according to the application scenario of the camera. Image programs provide a quick and simple method for adjusting the camera to the application scenario as they perform several configuration steps at once (**Image Programs Quick Control**).
- **Set the resolution of the live image:** By default, all MOBOTIX cameras are factory-set to an image resolution of 640x480 pixels. You can select the desired resolution using the **Resolution Quick Control**.
- **Adjust the exposure:** The automatic exposure control of the MOBOTIX camera uses individually configurable exposure windows to determine the best image exposure. Open the **Exposure Control Quick Control** and select a predefined set of exposure windows. If required, you can also define custom exposure windows (**Setup Menu > Exposure Settings**).
- **Activate event control and recording:** By default, the MOBOTIX camera's event control is disabled. Click on the **Arm & Record** button to activate event control. This will activate motion detection and recording. Cameras with integrated flash memory (MOBOTIX R models and models with an SD card) will automatically use the flash memory to store image and video data (recording target). If desired, you can set additional events and adjust the settings of the recording and storage parameters (**Setup Menu > Event Settings**, **Setup Menu > Recording** and **Admin Menu > Recording to External File Server / Flash Device**).

- **Set up actions/messaging:** Upon detecting an event, the MOBOTIX camera can trigger alarms. These alarms can be adjusted to your needs and you can assign them to a specific event: playing back an alarm sound on the camera speaker, showing the visual alarm in the camera live image, sending an e-mail or network message with the alarm image, placing a phone call, uploading an alarm image to an FTP server, switching a signal output line of the camera (for example, for switching on the lights/opening a door).

For the settings, see **Setup Menu > Action Group Overview**. The actions to be performed are defined and used in these action groups in the form of "action profiles." The different action profiles can also be defined in the following areas: Admin Menu in the Hardware Configuration (profiles for signal output), Transfer Profiles (FTP, e-mail, network messages) and Sound and VoIP Telephony (sound profiles, VoIP profiles). For more information, refer to the online help for the **Action Group Overview** dialog box.

- **Activate shock detector:** The M25 is also equipped with a shock detector as standard. If, for example, the camera's housing receives a blow, it automatically registers it and sends a notification via a network message or telephone call. A general advantage is that MOBOTIX cameras are extremely tough because of the absence of mechanical moving parts. This allows them to stay fully operational when they are subject to strong vibrations. Open the **Setup Menu > Event Control > Environment Events > Edit** dialog box if you would like to activate the shock detector (and any other sensors).

Additional Notes

3.6 Additional Notes

3.6.1 Protecting the Camera Against Condensation

Due to its robust and carefully constructed design and the lack of mechanical moving parts, the M25 has some outstanding weatherproof features and is resistant to moisture and dust. Certified according to the **IP66 standard**, the camera is even resistant to water jets but is **not completely airtight**. Installation environments that experience **frequent changes in temperature and humidity may cause condensation to occur and build up** in the cavities of the camera mount through which outside air flows.

Condensation is caused when the temperature of warm moist air, which can absorb less water in a cooler state, falls below dew point. The condensation is the water that condenses when it meets the cool surface of an object.

To prevent condensation from building up, MOBOTIX recommends **drilling a hole corresponding to the size of the space in question** in -only- the lower of the two positions pictured here and breaking through the outermost housing wall before mounting the camera.

Before drilling, separate the camera from its housing by removing the two Allen lock screws in order to prevent damage occurring to the camera or the cabling.



Use 2 mm drill bit



Before drilling,
remove the camera
from the housing



Depending on the later tilt of the camera, drill through the front or rear drain hole of the camera's weatherproof housing.

Camera tilted upwards: Drill through rear drain hole



Camera tilted downwards: Drill through front drain hole

TILT (UP)



TILT (DOWN)



When cleaning the camera with a water jet, do not use high-pressure cleaners. The drain holes should be sealed with adhesive tape during cleaning.

3.6.2 Password for the Admin Menu

Accessing the Administration Menu of the camera (**Admin Menu** softbutton) is only possible after entering a user name and password.

- Factory default user name is **admin**.
- Factory default password is **meinsm**.

The **Quick Installation** assistant automatically appears when the Administration Menu is accessed for the first time. It provides an easy method to adjust the basic camera settings to the current application scenario. For security reasons, we highly recommend changing the default administrator password after the camera has been properly configured.

Enter the user name and password exactly as shown above. Note that all entries are case-sensitive.

Caution

Make sure that you store information on **user names and passwords** in a secure place. If you lose the administrator password and cannot access the administration menu, the password can only be reset at the factory. This service is subject to a fee!

3.6.3 Permanently Deactivating the Microphone

Deactivating a camera's microphone may be necessary in order to protect the privacy of persons at a workplace or for other reasons. You can permanently and irreversibly deactivate the microphone in the **Admin Menu > Loudspeaker and Microphone** dialog box.

The microphone can be irreversibly deactivated!

3.6.4 Starting the Camera with the Factory IP Address

If the camera's IP address is not known, you can start the camera with its factory IP address. *Section 3.2.4, «Starting the Camera with Factory (Network) Settings»* describes this procedure in more detail.

3.6.5 Resetting the Camera to Factory Settings

All settings of the MOBOTIX camera can be permanently reset to the factory default settings. This makes sense if you have, for example, obtained a camera without any information or you would like to reset all settings after testing the camera. In order to perform this procedure, you need to have administrative access to the camera (admins group). Open **Admin Menu > Reset** to reset the camera to factory defaults.

You can reset specific parts of the configuration

Note

All defined users are deleted and the admin password is reset to the factory default when you reset the camera using **Admin Menu > Reset**. If you want to maintain the existing users, use the method described in *Section 3.2.4, «Starting the Camera with Factory (Network) Settings»*.

3.6.6 Activating Event Control and Motion Detection

In its default configuration, the camera's event control and video motion detection features are not enabled. In order to activate event-controlled recording, open **Setup Menu > General Event Settings** and activate the Arming switch. Another method is to click on the **Arm & Record** softbutton in the browser's user interface. The camera displays the motion detection window in the live image (dotted frame in the center) and the camera automatically stores images as soon as the motion detection window detects movements.



If the dotted rectangle in the live image is visible, the camera is armed

3.6.7 Deactivating Text and Logo Options

As camera arming is deactivated in the camera's default configuration (see preceding section), the MOBOTIX camera only displays the text `www.mobotix.com`, the time stamp and the MOBOTIX logo at the top of the image. Once the camera arming has been activated, the text at the bottom of the live image (event, action, messaging and recording symbols) will also appear.

Text and logos can be also deactivated or individually configured

You can deactivate the status bar at the bottom of the live image and the text bar in the top left-hand corner by setting Text Display in the **Setup Menu > Text & Display Settings** dialog box to **Off**. Setting Text Display to **Date and Time** will only display the time stamp in the live image. To hide the logo in the live image, open **Admin Menu > Logo Profiles** and set **Logo Display** to **Deactivated**.

3.6.8 Deactivating the Camera Reboot

By factory default, the MOBOTIX camera automatically reboots once a week between 3 a.m. and 4 a.m. The reason for this is that in some rare cases, external influences (for example, radiation at high altitudes) can sometimes lead to camera malfunctions. The automatic reboot will refresh the camera's memory and will ensure proper operation without requiring any interaction on the part of the user. If desired, you can deactivate the automatic reboot of the camera in the **Admin Menu > Time Tasks** dialog box.

3.6.9 Browser

Current Internet browsers (Internet Explorer, Mozilla Firefox, Safari, Google Chrome, Opera, etc.) with enabled JavaScript can display the camera's live images with their standard settings.

3.6.10 Cleaning the Camera and Lens

If the lens becomes dirty during the installation process, clean the lens using a lint-free cotton cloth. Make sure that the lens is still in focus after cleaning and adjust its focus if required.

Cleaning the Lens Cover:

- Always mount and unmount the lens cover using a soft cotton cloth in order to protect it from being scratched and from getting dirty.
- You should clean the lens cover at regular intervals. Always use a soft, lint-free cotton cloth for this purpose.
- If the dirt is more persistent, add a mild alcohol-free detergent without abrasive particles.
- Make sure you instruct cleaning personnel on how to clean the camera.



3.6.11 Legal Notes

Legal aspects of video and sound recording: You must comply with all data protection regulations for video and sound monitoring when using MOBOTIX products. Depending on national laws and the installation location of the M25, the recording of video and sound data may be subject to special documentation or it may be prohibited. All users of MOBOTIX products are therefore required to familiarize themselves with all valid regulations and comply with these laws. MOBOTIX AG is not liable for any illegal use of its products.



3.6.12 Safety Warnings

Installation Instructions:

- This product must not be used in locations exposed to the dangers of explosion.
- Make sure to install this product as shown in *Chapter 2, «Installation»* of this manual.
- When installing this product, make sure that you are only using genuine MOBOTIX parts and MOBOTIX connection cables.
- Make sure that you are installing this product on a solid surface that provides for a sturdy installation of the fixing elements used.

Electrical installation: Electrical systems and equipment may only be installed, modified and maintained by a qualified electrician or under the direction and supervision of a qualified electrician in accordance with the applicable electrical guidelines. Make sure to properly set up all electrical connections.

Electrical surges: MOBOTIX cameras are protected against the effects of small electrical surges by numerous measures. These measures, however, cannot prevent the camera from being damaged when stronger electrical surges occur. Special care should be taken when installing the camera outside of buildings to ensure proper protection against **lightning**, since this also protects the building and the whole network infrastructure.

Max. power consumption of attached extension modules: The power consumption of all attached **MxBus modules** must **not exceed 2.5 W**. When attaching modules to the MxBus connector **and** the USB connector, the **power consumption of all attached modules must not exceed 3 W, if the camera is powered by PoE class 3**. If **PoE class 2** is used, **the power consumption of all attached modules must not exceed 1 W!**



Never touch the lens: Due to the high performance of the M25, the area of the image sensor **can get quite hot**, especially when the ambient temperature is also high. This does not affect the proper functioning of the camera in any way. For this reason, the product must not be installed within the reach of persons without the lens cover.

Power off before opening the camera: Make sure the power supply is disconnected before opening the camera (i.e., for installing or replacing sensor modules and SD cards).

Network security: MOBOTIX products include all of the necessary configuration options for operation in Ethernet networks in compliance with data protection laws. The operator is responsible for the data protection concept across the entire system. The basic settings required to prevent misuse can be configured in the software and are password-protected. This prevents unauthorized parties from accessing these settings.



3.6.13 Online Help in the Browser

For more information, see the News and Functional Overview pages in the online help of the camera's browser interface. Click on the  icon to open the camera's online help. Furthermore, detailed information on the camera and its current configuration is displayed in the **Camera Status** dialog box. Click on the  icon to open the relevant page.

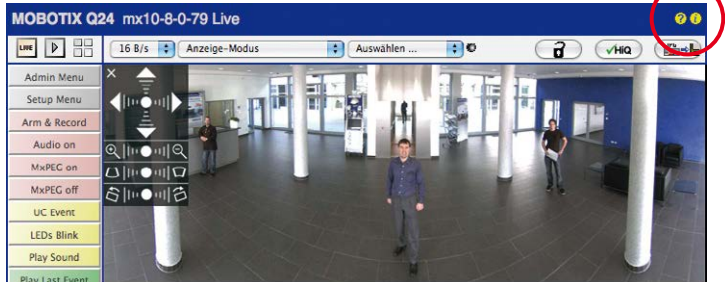

3.6.14 Declaration of Conformity

The products of MOBOTIX AG are certified according to the applicable directives of the E.U. and other countries. You can find the declarations of conformity of the products of MOBOTIX AG under www.mobotix.com, **Support > MX Media Library > Certificates > Declarations of Conformity**.

3.6.15 Disposal

Electrical and electronic products contain many reusable materials. For this reason, we would ask that you dispose of MOBOTIX products at the end of their service life in accordance with all legal requirements and regulations (or deposit these products at a municipal collection center). MOBOTIX products may not be disposed of with household waste! If the product contains a battery, please dispose of the battery separately (the corresponding product manuals contain specific directions if the product contains a battery).

3.6.16 Disclaimer

Neither MOBOTIX AG nor any subsidiary of MOBOTIX AG will assume any responsibility for damage resulting from improper use of its products or failure to comply with the manuals and the applicable rules and regulations.

Our **General Terms and Conditions** apply. You can download the current version of the General Terms and Conditions from our website at www.mobotix.com by clicking on the **cos** link at the bottom of every page.





Notes

A series of horizontal dashed lines for taking notes.



To demonstrate our confidence in the quality of our products, MObOTIX cameras have been used to capture all images that appear in this manual.

Manufacturer

MObOTIX AG
Kaiserstrasse
67722 Langmeil
Germany

Phone: +49 6302 9816-103

Fax: +49 6302 9816-190

www.mobotix.com

sales@mobotix.com

Registration Office: Kaiserslautern Local Court

Registration Number: HRB 3724

Tax Office: Worms-Kirchheimbolanden, Germany

Tax Code: 44/676/0700/4

VAT ID: DE202203501

You can find the latest version of this and other documents (e.g., declarations of conformity) at www.mobotix.com in the **Support** section.



Technical specifications subject to change without notice!

© MObOTIX AG • Security-Vision-Systems • Made in Germany

www.mobotix.com • sales@mobotix.com



More Camera For Less. Guaranteed!

The M25 series from MOBOTIX offers extremely compact, cost-effective and exceptionally powerful 6MP allround cameras with the widest range of lenses, including panorama version. Fully equipped with IP66-certified housing and long-term internal storage on a MicroSD card.

M25 Allround B036 to B500



M25 Allround B016



M25 Allround CSVario



6MP
Sensor

MxLEO



360°

vPTZ



MxBus

USB

+50°
-30°

IP66



Innovations - Made in Germany

The German company MOBOTIX AG is known as the leading pioneer in network camera technology and its decentralized concept has made high-resolution video systems cost efficient.

MOBOTIX AG • D-67722 Langmeil • Phone: +49 6302 9816-103 • Fax: +49 6302 9816-190 • sales@mobotix.com