

TOUCHLOCK stainless steel keypad - K38/K50/K75/K75 screw connector

System specifications

Cable Length	5m/16ft (Screw connector - None)	
Cable extension length and type	≤ 25m/82ft ≤ 100m/328ft	Belden 9538/ Belden 5506FE (USA) Belden 9540/ Belden 5306FE (USA)

Electrical

Operating Voltage	10V - 14V DC
Current consumption	180mA

Environment

Operating temperature	-35°C - +66°C -31°F - +151°F
Moisture resistance	IPX7 (Screw connector- No)
Vandal Resistance	Medium



The stainless steel K38/K50/K75/K75 screw connector Keypads are devices that offer the simplicity of PIN or Code authentication for system users.

They are available for use with both Switch2 and Net2 systems. The reader is wired as shown on the control unit label.

The 75 Series variant is also optionally available with a screw connector version making cabling even simpler.

By default, all 3 LEDs are lit. If access is granted, the green LED flashes. If access is denied, the red LED flashes. An audible tone is emitted in both cases.

K38ss

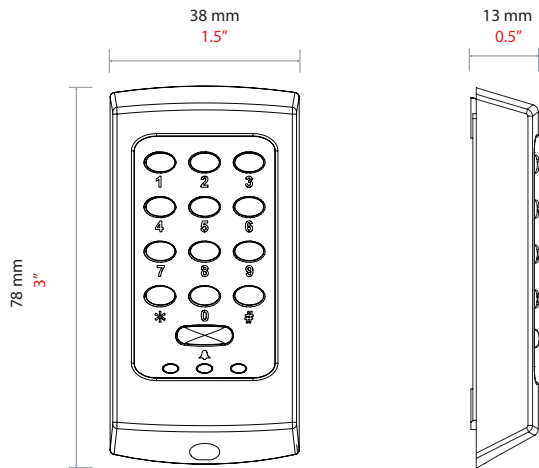

K50ss

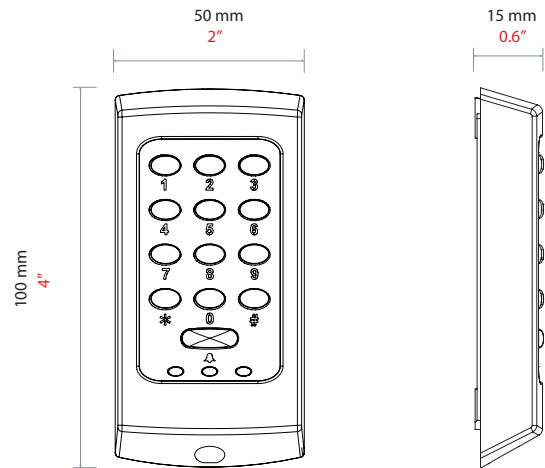

K75ss

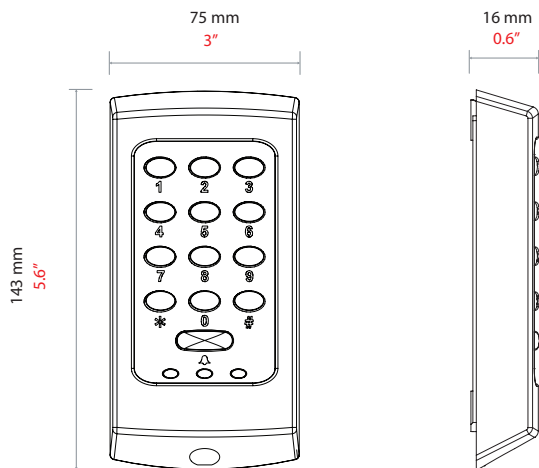

K75ss,sc

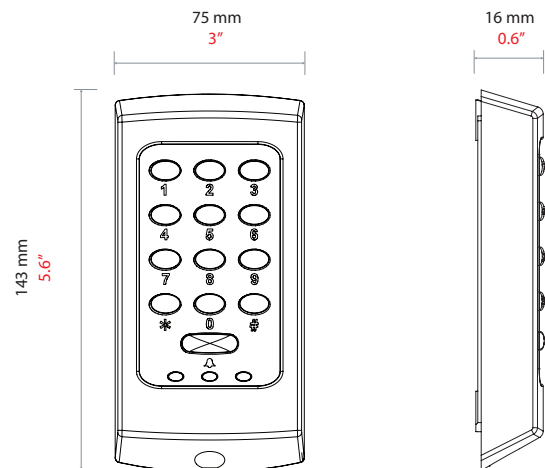

Accessories and sales codes

TOUCHLOCK stainless steel keypad - K38 332-110

TOUCHLOCK stainless steel keypad - K75 372-110

TOUCHLOCK stainless steel keypad - K50 352-110

TOUCHLOCK stainless steel keypad - K75, Screw connector 372-120