

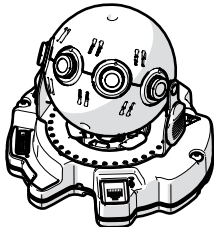

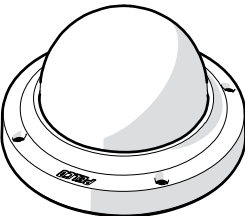



Optera IMM Installation

Parts List

All Models					
					
Camera	Lower Dome	Documentation	2 Mac Address Labels	T20 Bit	8-Pin Connector
In-Ceiling Models	Surface Mounts Models		Pendant Models		
					
Back Box	Mounting Plate	Surface Mount	Pendant Mount	Anti-Seize Lubricant	

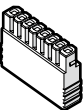
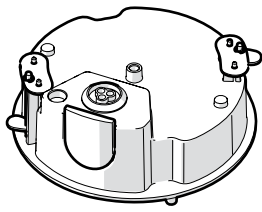
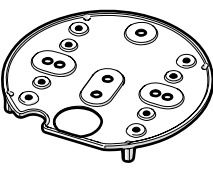
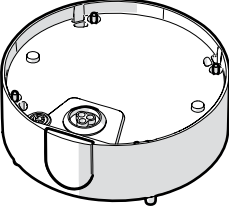
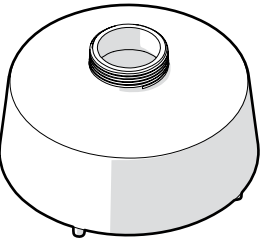
Unsupplied Parts

All Models

- Pipe/conduit (if applicable)
- Conduit adapters (if applicable)
- Cat5 (or higher) cable, appropriately terminated for POE+
- 24 AWG, 8-wire multiconductor cable (if using alarm, relays, and/or audio)
- SD card, 32GB SanDisk Extreme® PLUS microSDHC™ UHS-I

Surface Mount Models

- 1 of the following mounting substrates and fasteners:
- Standard 4 in. square electrical box and appropriate fasteners
 - Standard 2-gang electrical box and appropriate fasteners
 - Any substrate using 3 standard screws, size M6 or 1/4 in.

Pendant Models

- WMVE-SR Wall Mount (if using the wall mount for environmental and vandal-resistant models)
- WMVE-SW Wall Mount (if using the wall mount for indoor models)

Product Overview

NOTICE: Pelco recommends installing the camera at a height of 3 meters (10 feet) or higher for best results. To ensure an unobstructed view, the expected field of view should be at least 4 meters (12 feet) away from the camera.

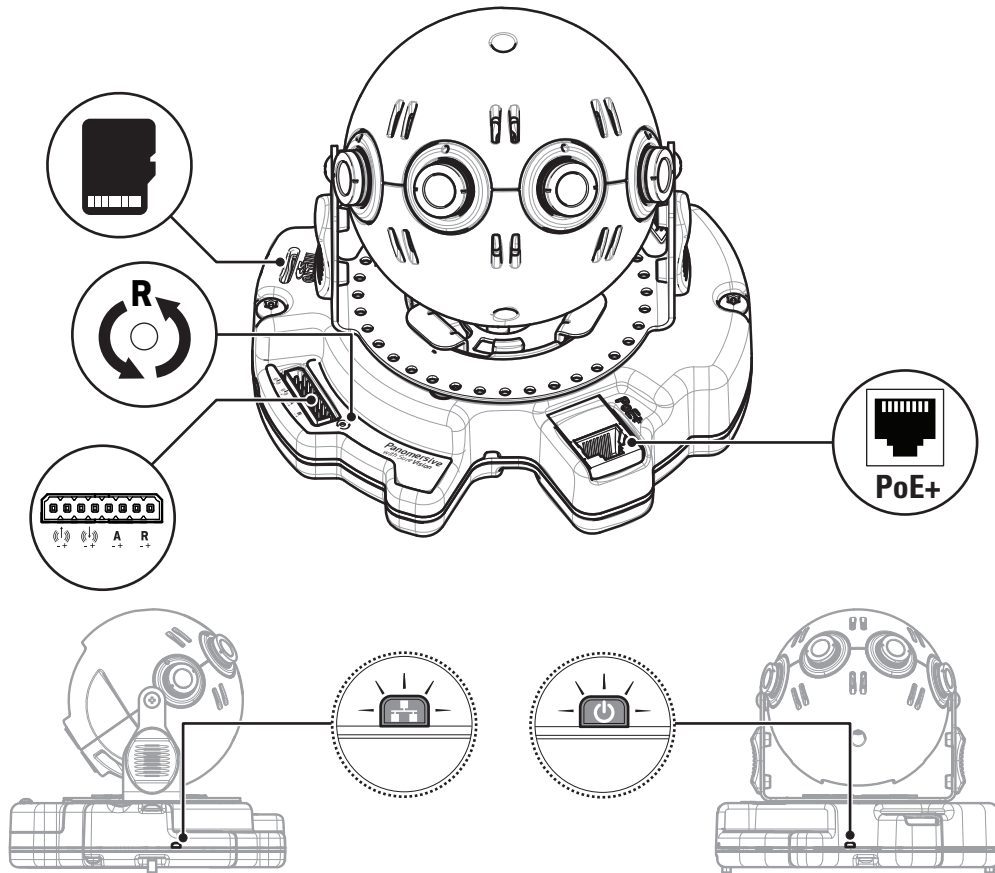

To ensure reliable local storage, Pelco recommends using a new 32 GB SanDisk Extreme® PLUS microSDHC™ UHS-I card. If the card has been used or reformatted, local storage may not function properly.

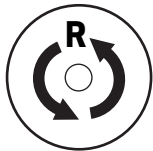

Using a small tool, like a paper clip, press once to restart the camera. Press and hold for 10 seconds to restore the camera to factory settings.



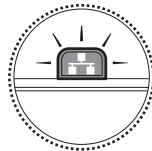

- *Flashes green:* cycling power.
- *Solid Green:* power is active.

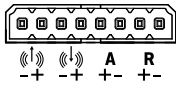

- *Flashes green:* network activity
- *Solid amber:* 1000 Mbps network connection
- *Solid green:* 100 Mbps network connection
- *Red (solid or flashing):* contact Pelco Product Support at 1-800-289-9100 (USA and Canada) or +1-559-292-1981 (international).

Wiring Information

		 PoE+		
Pin	Function	Pin	PoE+ Mode A	PoE+ Mode B
1	Audio Out-	1	TX+, PoE+ 1-2	TX+
2	Audio Out+	2	TX-, PoE+ 1-2	TX-
3	Audio In-	3	RX+, PoE+ 3-4	RX+
4	Audio In+	4	Not used	PoE+ 1-2
5	Alarm Input	5	Not used	PoE+ 1-2
6	Ground	6	RX-, PoE+ 3-4	RX-
7	Relay N.O.	7	Not used	PoE+ 3-4
8	Relay Return	8	Not used	PoE+ 3-4

Installing the In-Ceiling Mount

1.

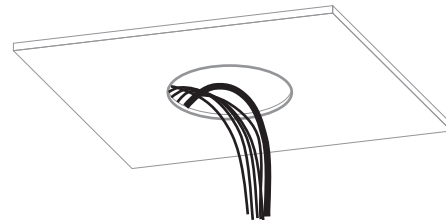
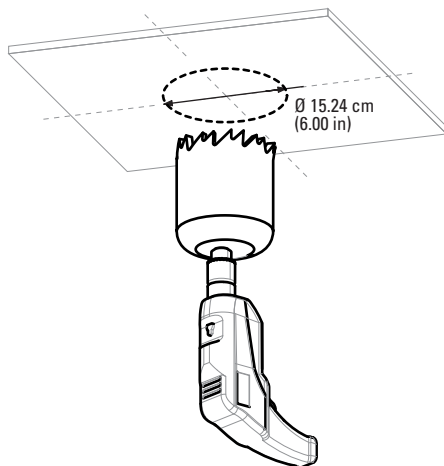

2. Remove either the conduit plug (side) or grommet (top) for side or top wire entry.

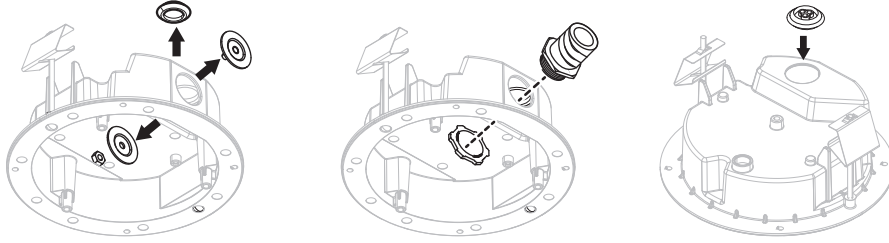

3. Prepare the wire entry holes. If using the supplied grommet (plenum rating is not required), set the grommet aside for use later. If using conduit (not supplied), replace with 25mm or 2/4 in. conduit adapters.

Installing the Back Box

1. Ensure that the support wings are rotated inward, and push the back box through the mounting hole.
2. Replace the other entry opening with the supplied conduit plug.
3. Tighten the two mounting screws to secure the back box using the supplied bit.
4. Feed the wires:
 - **If using conduit (not supplied):** Feed wires through the conduit adapter, into the back box, and attach the conduit to the adapter.
 - **If using the grommet (supplied):** Feed the wires into the back box; pass the unterminated cables through the grommet; and then insert the grommet.
5. Terminate the wires using an appropriate connector (not supplied).

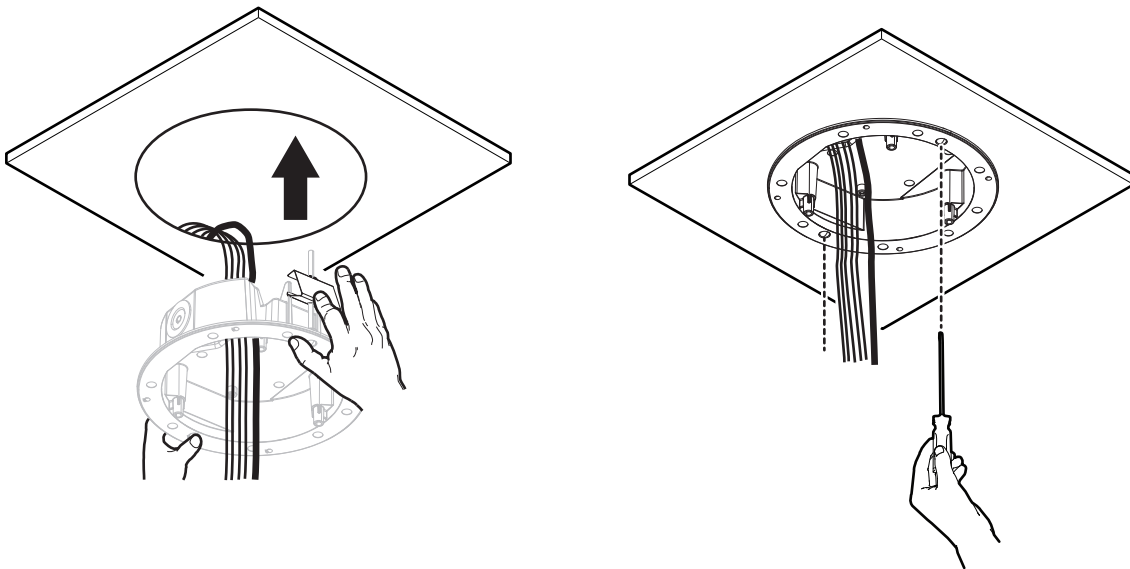

Installing the Pendant Mount

The pendant mount attaches to 1-1/2 in. NPT pipe/conduit or wall mount with 1-1/2 in. NPT thread (not supplied).

1. Apply anti-seize lubricant to the NPT pipe/conduit, and install the pendant mount to the conduit.

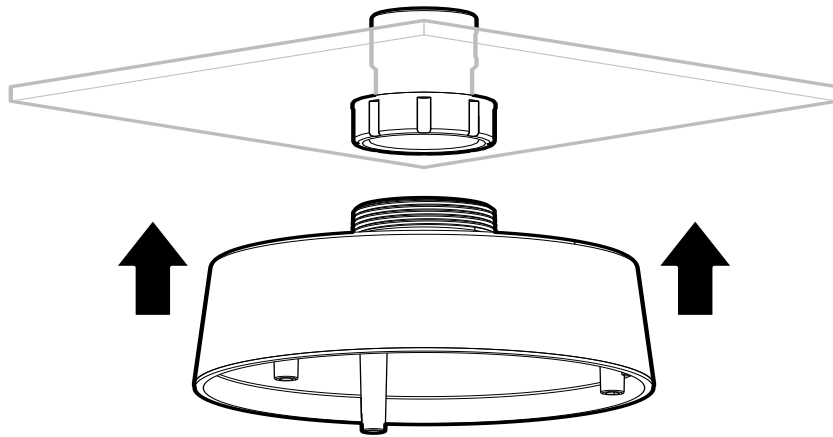

2. Pull the wiring through the opening.

Installing the Surface Mount

1. Reference the Surface Mount template and Install the mounting plate to the mounting substrate to one of the following:

- Standard 4 in. square electrical box (not supplied).
- Standard 2-gang electrical box (not supplied).
- Any substrate using standard screw size M6 or 1/4 in. hardware (not supplied)

NOTE: Head height and diameter of fasteners are not to exceed 5/16 in. and 3/4 in., respectively.

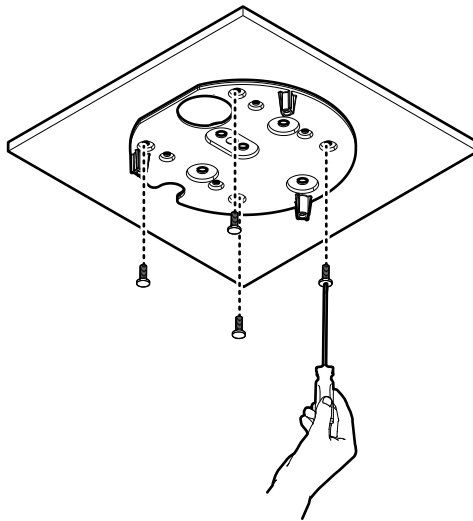

2. Remove either the conduit plug (side) or grommet (top) wire entry.

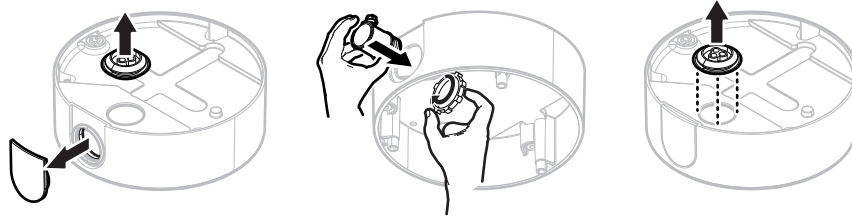

3. Prepare the wire entry holes:

- **If using the grommet:** Put the grommet (supplied) aside for use in a later step.
- **If using conduit (not supplied):** Insert a 25 mm or 3/4 in. conduit adapter (not supplied). For Environmental Vandal cameras, the conduit adapter and compression glands must be rated for IP66/NEMA 4 applications.

4. Install the surface mounting ring to the mounting plate and use a hand driver to tighten the four tamperproof captive fasteners using the supplied bit.

5. Pull the wiring through the opening:

- **If using conduit (not supplied):** Feed the wires through the conduit adapter into the surface mounting ring, and attach the conduit to the adapter.
- **If using the grommet:** Feed the wires into the surface mounting ring, pass the unterminated cables through the grommet, and insert the grommet in the top entry.

Installing the Camera

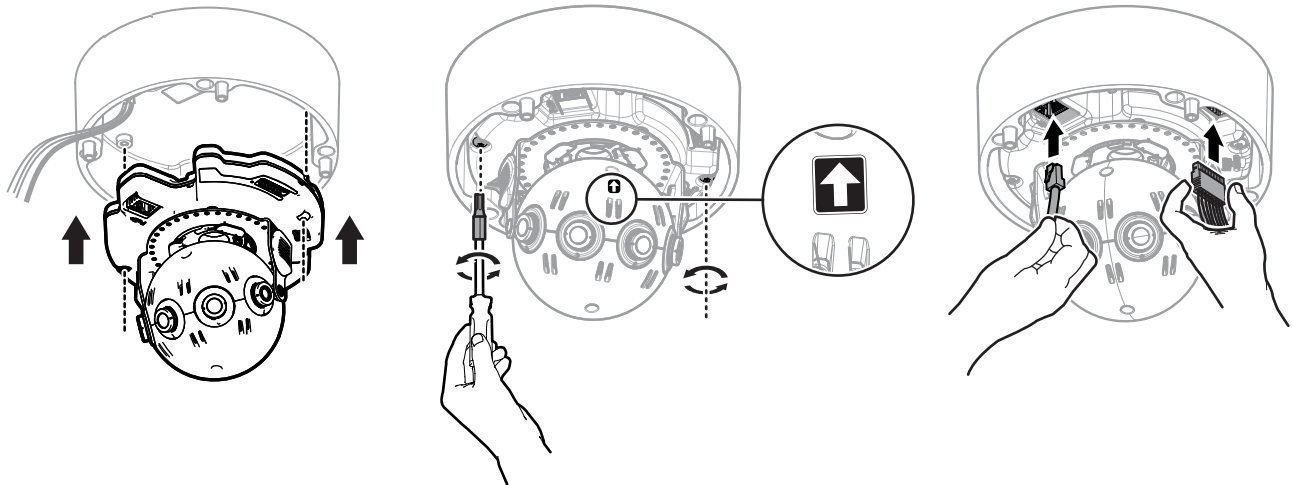

NOTICE: Take care not to touch the camera lenses during installation.

Dress the wires inside the mount or back box when you finish installing the camera.

Camera Configuration Sequence

When you apply power to the camera, the camera undergoes a configuration sequence, taking approximately two minutes to complete and come online. If the camera connected to a network without a DHCP server and DHCP is enabled, the configuration sequence can take up to five minutes to complete.

IP Address Settings

By default, the camera attempts to obtain an address via DHCP.

You can find and access your camera using Pelco's Device Utility. If the camera is not connected to a network containing a DHCP server but DHCP is set to On (as it is by default), the camera automatically assigns itself a default IP address 192.168.0.20 on subnet mask 255.255.255.0. Additional cameras will assign themselves IPv4 link local addresses and the next available 192.168.0.x IP addresses in sequential order.

Accessing the Camera for the First Time

Open a web browser, and enter the camera's IP address to access and configure your camera

By default, the camera possesses no user accounts; you can connect to the camera and configure it without authentication. You must configure a user account to enable authentication and secure the camera. You can configure user accounts from the Users page, under the Users menu.

Adjusting the Field of View

When you have completed the installation process, and the camera has fully started-up, you can use the camera's web browser to view live video and adjust the field of view.

1. Connect to the camera's web interface and log in to view the camera's field of view.
2. Manually adjust the camera's field of view if necessary:

- a. Slightly loosen the locking screws (2) with the bit (supplied).
- b. Reposition the camera.

NOTE: Only the 180° models tilt as shown in the example below. Do not try to tilt 270° and 360° models.

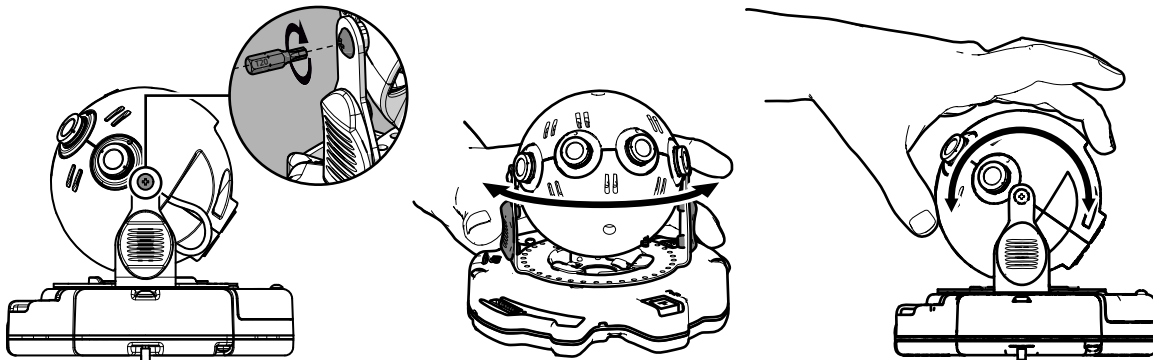

- c. Tighten the locking screws (2) with the bit (supplied).
- d. Gently clean the camera lenses with a microfiber lens cloth.

Installing the Lower Dome

NOTICE: You must install the lower dome to ensure proper sensor alignment and image focus.

1. Align the trim ring screw holes with the mount holes.
2. Tighten the fasteners using a hand driver. Ensure that there is no gap between the lower dome and the back box.

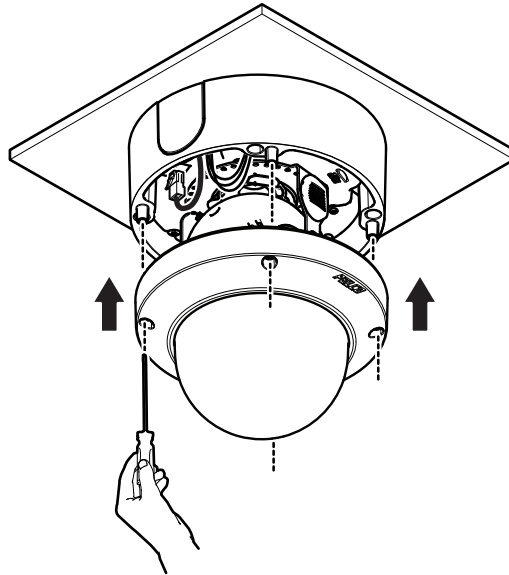

Surface Mount Template

Print this template at actual size (100%) to match mounting holes on the surface mounting plate.

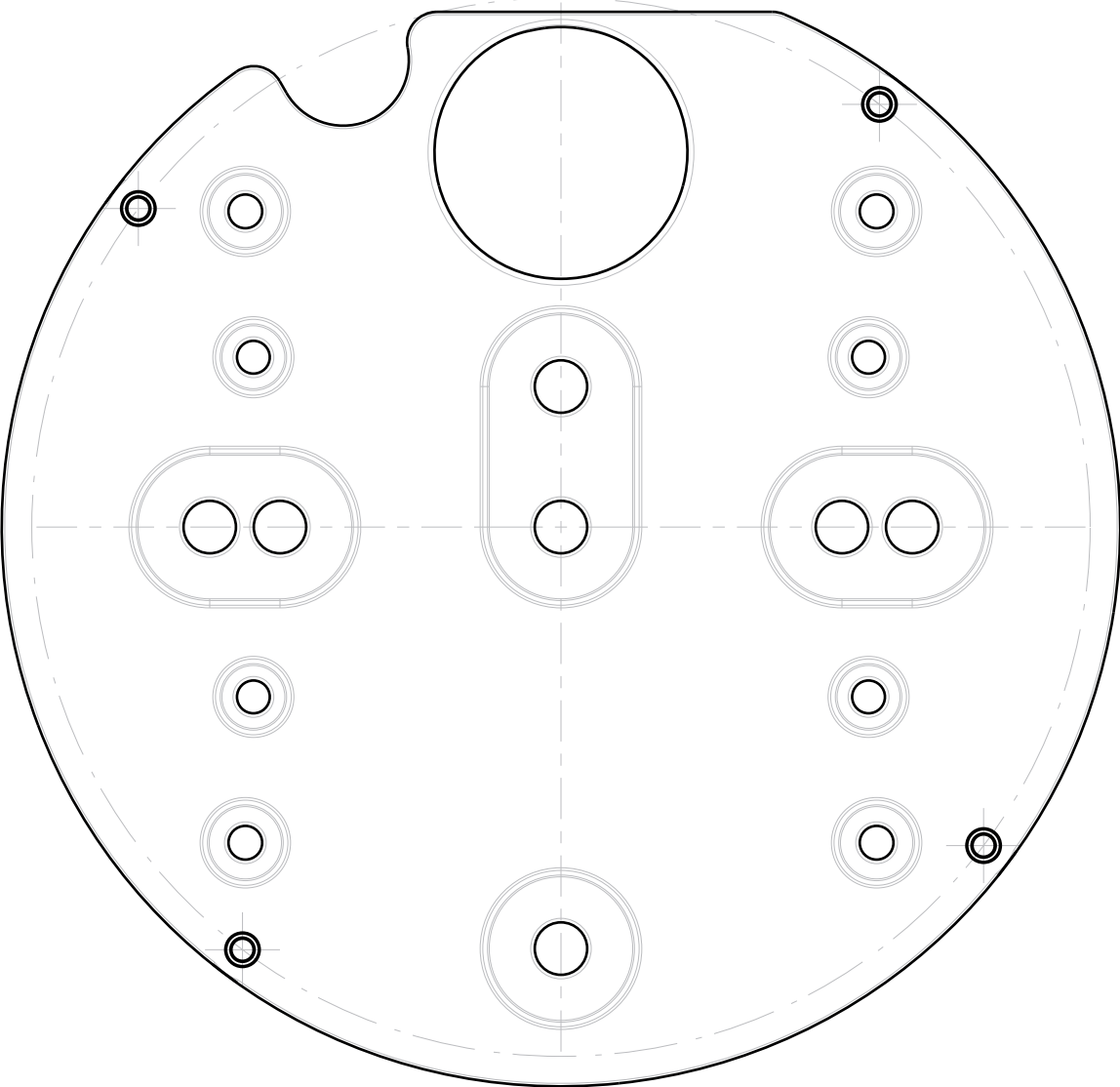

In-Ceiling Mount Template

Print this template at actual size (100%) to match mounting holes on the surface mounting plate.

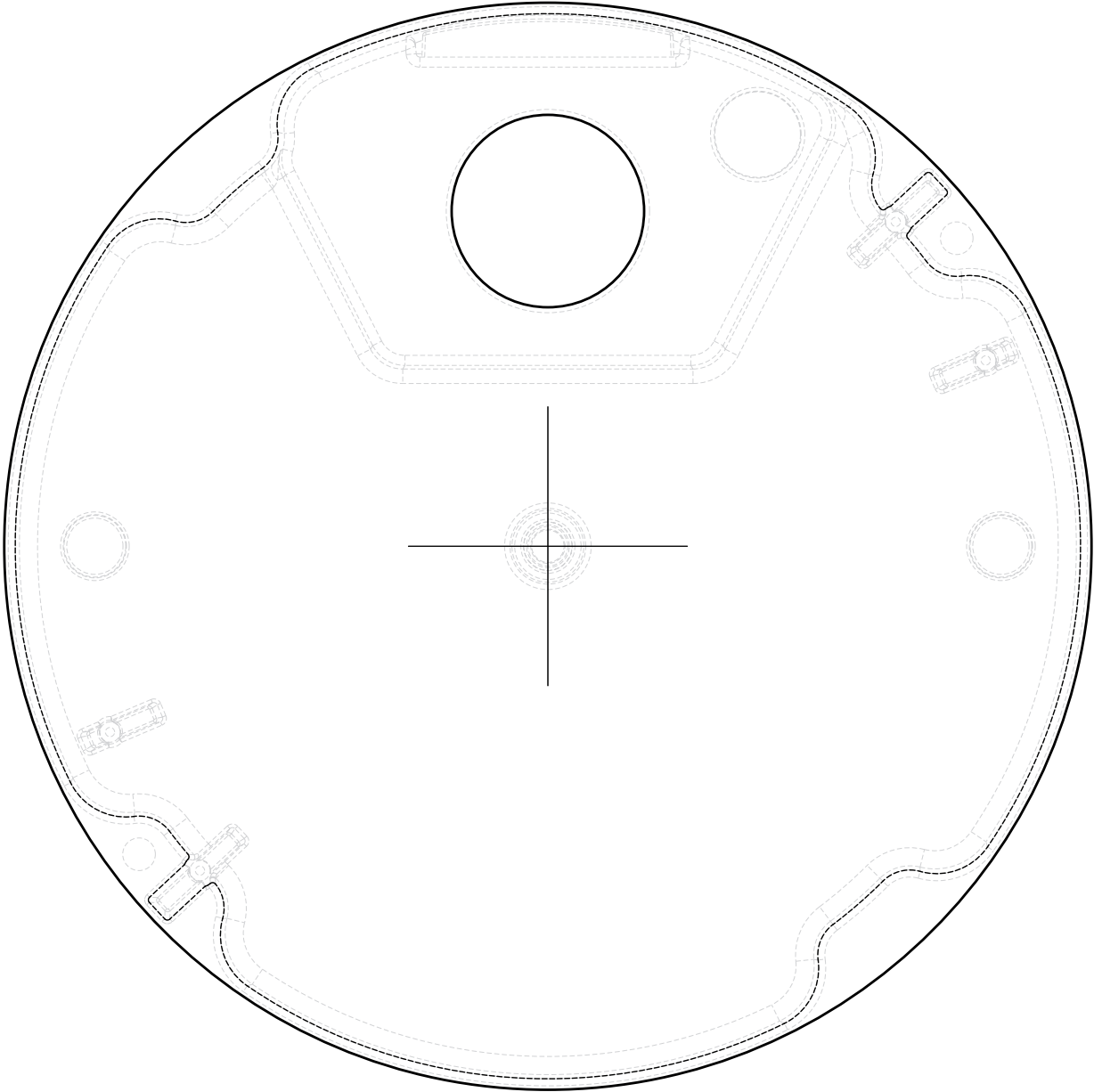

Pelco, Inc.

625 W. Alluvial Avenue, Fresno California 93711 USA

(800) 289-9100 Tel (800) 289-9150 Fax

+1 (559) 292-1981 International Tel

+1 (559) 348-1120 International Fax

www.pelco.com

Pelco, the Pelco logo, and other trademarks associated with Pelco products referred to in this publication are trademarks of Pelco, Inc. or its affiliates. ONVIF and the ONVIF logo are trademarks of ONVIF Inc. All other product names and services are the property of their respective companies. Product specifications and availability are subject to change without notice.

© Copyright 2015, Pelco, Inc.
All rights reserved.