



- PLATINUM SMT LED Technology
- Up to 14,000 delivered lumens
- Excellent efficacy >140lm/w
- 40W, 60W, 80W and 100W variants
- 5 year warranty
- X-treme durability and toughness
- Lightweight design
- UK designed and manufactured
- Intelligent & programmable driver options
- Optional photocell

The Urban-X Pro is a powerful, lightweight luminaire, designed for a range of perimeter, fence line, street, pathway and industrial lighting applications and is designed and manufactured in the UK.

The Urban-X Pro utilises the latest, high power, PLATINUM SMT LEDs to deliver a high lumen output of up to 14,000 delivered lumens on scene. It produces a highly even light distribution with excellent colour rendition. With a low power consumption and high efficacy, the URBAN-X Pro delivers class leading energy savings.

The luminaire offers X-treme levels of durability and toughness. Every unit is produced from LM6 marine grade cast aluminium and is supported by a 5 year warranty. All Urban-X Pro luminaires are environmentally protected (IP66) with a wide temperature range (-30°C to +60°C (-22°F to 140°F) and -30°C to +40°C (-22°F to 104°F) for 100W variants). They also have in-built protection from electrical surges (2kV with photocell, 8kV without photocell) and are impact resistant (IK08).

Urban-X Pro is available with an optional photocell and, thanks to its intelligent driver, customers can also choose from several pre-installed driver programs. Raytec can also develop bespoke programs tailored to a customer's exact requirements. Meanwhile, DALI compatibility gives users greater levels of control and functionality.

Product Dimensions

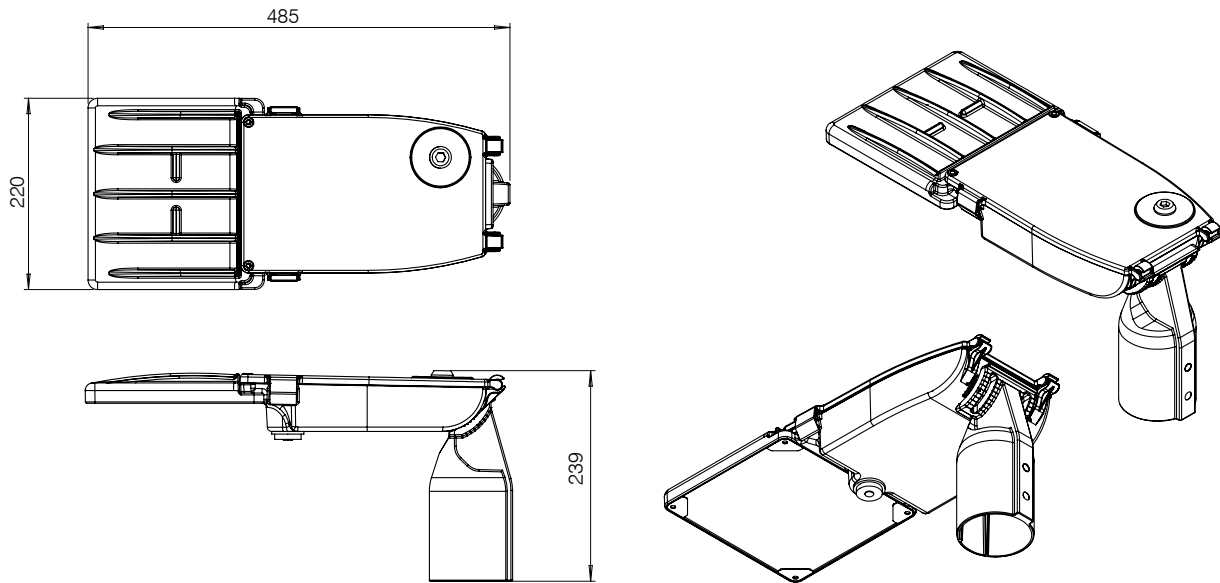

Features	Benefits
PLATINUM SMT LED Technology	The Urban-X Pro utilises the latest PLATINUM SMT LED technology together with an enhanced Cool Running™ thermal management system to deliver excellent performance and a light output of up to 14,000 lumens
Energy Saving	With a low power consumption of up to 100W, and a high efficacy of 140lm/w, the luminaire delivers significant energy savings and outstanding optical performance
X-Treme Durability and Toughness	The Urban-X Pro is manufactured from LM6 marine grade cast aluminum to give environmental protection (IP66) and safeguard against high salinity, while also being impact resistant (IK08). An inbuilt automatic thermal control (ATC) makes the luminaire suitable for high temperature installations and every unit features surge protection (2kV with photocell, 8kV without photocell)
Optics for Any Application	A wide choice of beam patterns tailored to achieve the best results for specific applications such as pathway, perimeter and area lighting
Lightweight	Every Urban-X Pro is a 2 piece, lightweight design (under 4kg) which means the luminaire can be safely fitted to most mounting columns
Intelligent and Controllable	Urban-X Pro is available with a variety of options including a fully programmable driver and/or an optional photocell for full intelligent lighting installations. Intelligent features include DALI compatibility, part night dimming, time & scheduling commands
Integrated Adjustable Bracket	With an adjustable bracket that can be rotated 90°, the luminaire can be fixed to any column, bracket or pole in post top or side arm configuration

5 YEAR WARRANTY

All Raytec luminaires are provided with an industry leading 5 year warranty and have an expected useful life in excess of 10 years



Technical Specifications

Electrical

Input:	220-240V AC
Frequency:	50 - 60Hz
Power Factor:	>0.95 VAC at 230V 50Hz
Efficiency:	>80% 230VAC, Full load
Surge Protection:	Without photocell: 8kV With photocell: 2kV
Consumption:	40, 60, 80 and 100W versions (model dependent)

Mechanical and Control

Spigot (pole) Diameter:	Compatible with 60-76mm (2.36-2.99")
Bracketry:	Supplied with Integrated Spigot Mount with adjustable rotation
Finish:	Silver (RAL 9006) polyester powder coating
Cable Length:	None
Dimensions:	485 x 239 x 220mm (19.09 x 9.4 x 8.66")
Weight:	<4kg
Photocell:	Optional mini photocell

Optical

Total Lumens:	40W - 5,600lm 60W - 8,400lm 80W - 11,200lm 100W - 14,000lm
Angle:	See beam angle options below
LED Type:	PLATINUM SMT LED
Number of LEDs:	Model Dependent
Wavelength:	White-Light
Colour Temperature:	4000K (other options available)
Colour Reproduction Index (CRI):	≥70

Environmental and Safety

Temp Range:	-30°C to +60°C (-22°F to 140°F) with automatic thermal control (+40°C/104°F for 100W variants)
IP Rating:	IP66
Safety:	EN60598 Approved
Warranty:	5 Years
Country of Manufacture:	United Kingdom
Impact Resistance:	IK08
Salinity:	LM6 marine grade cast aluminium

Light Distribution

Urban-X is available with a choice of three standard beam angles to suit a wide range of applications (other options available).

Perimeter/Pathway - PP1

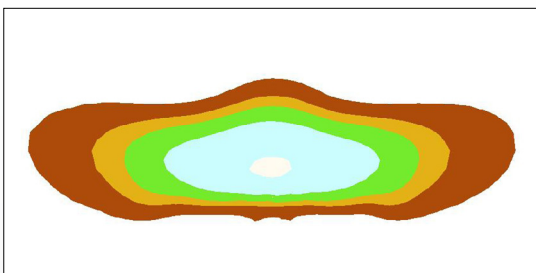

Perimeter/Pathway - PP2

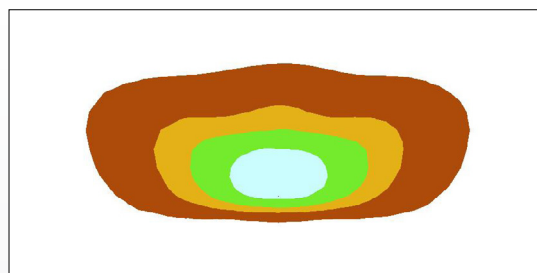

Area - AR1

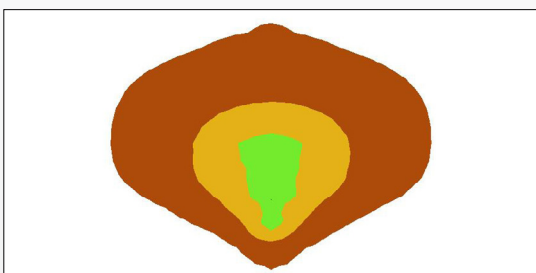

Beam angles and lux levels are based on a typical 100W installation with a 8m (26ft) mounting height over a 50x25m (164x82ft) area.

Intelligent Driver Program Options

The intelligent driver option in Urban-X allow the illuminator to be pre-programmed during manufacture to give the best performance for any application. Raytec offer 5 standard programming options:

ID1 - Soft Start

The luminaire operates at 100% output with a 5 second soft start from power being applied to the unit or from the photocell activation (when fitted).

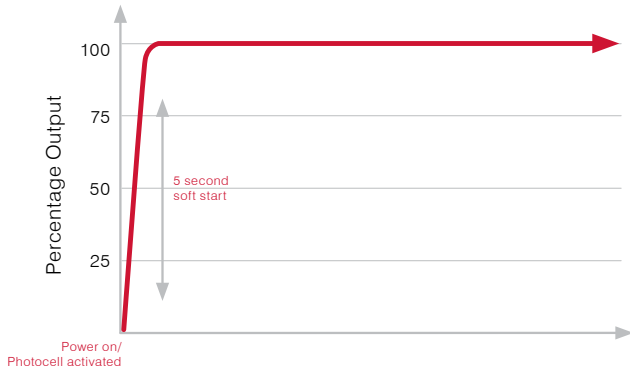

ID2 - Timer Dimming

The luminaire operates at 100% power for 5 hours from power being applied or from photocell activation (when fitted) and then switches to 50% power until the next cycle.

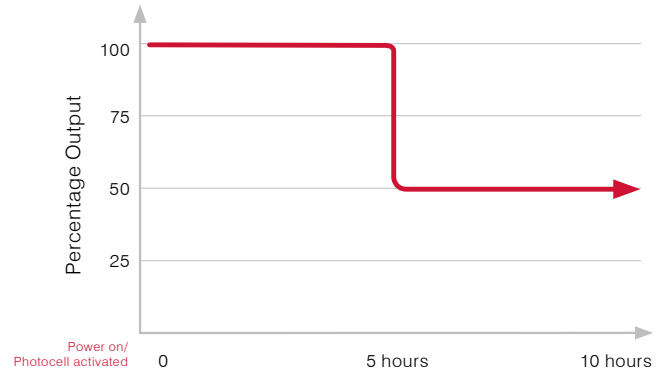

ID3 - Active Dimming 50%, ID4 - Active Dimming 25%

The luminaire's driver records the length of consecutive nights and dims to either 50% (ID3) or 25% (ID4) power, 1 hour before the midpoint of the night and up to 6 hours after, to deliver significant energy savings.

This program would typically require the use an inbuilt or remote photocell to monitor the hours of darkness.

Longer night (typical example) ■ ID3 ■ ID4

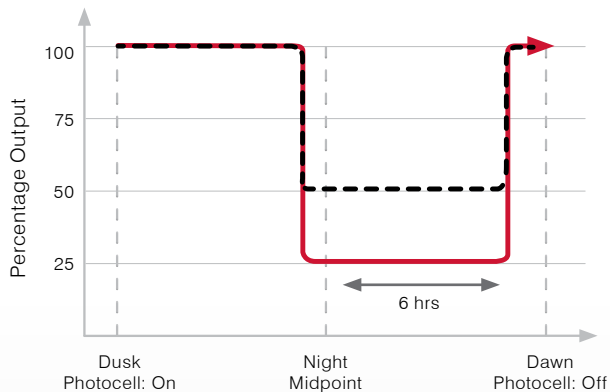

Shorter night (typical example) ■ ID3 ■ ID4

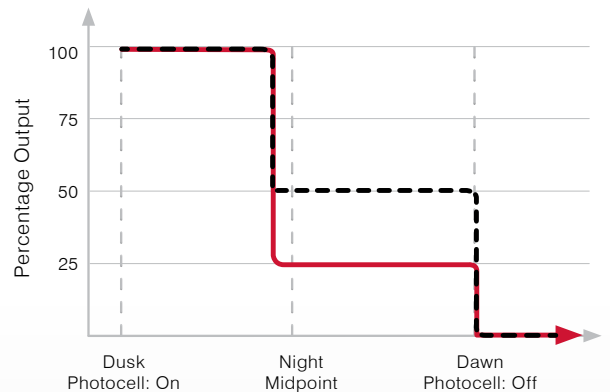

ID5 - Event Trigger

Designed to be used in conjunction with other control equipment, once power is applied, or triggered, the luminaire will operate at 100% for 30 minutes and then switch off until re-activated.

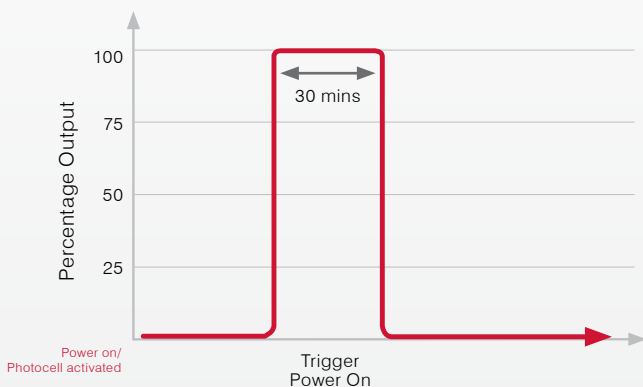

IDx - Custom

A customer specified intelligent driver program that Raytec will develop and pre-install (contact Raytec for more information).

*Programmes (ID2-ID4) also feature a 5 second soft start as shown in ID1

Product Code Builder

Example Order Reference: **UBXPRO40-4KPP2-ID1NP-2**

Core Product			Optics		Control		Input	Optional Extras
Product Family	Model Size	Wattage	Colour Temp*	Optics	Driver	Photocell	Input	Cable*
UBX (Urban X)	PRO (Pro)	40 (40W)	4K (4,000K)	PP1 (Path/perimeter 1)	ID1 (Soft Start)	PC (With photocell)	2 (220-240V)	8M (3 core cable, 8m)
		60 (60W)		PP2 (Path/perimeter 2)	ID2 (Timer Dimming)	NP (Without photocell)		12M (3 core cable, 12m)
		80 (80W)		AR1 (Area 1)	ID3 (Active Dimming 50%)			8MD (DALI cable, 8m)
		100 (100W)			ID4 (Active Dimming 25%)			12MD (DALI cable, 12m)
					ID5 (Event Trigger)			
					IDx (Bespoke options available. Contact Raytec for information)			

*Other options available

*Not supplied as standard