

# VAR2-i4-1 Medium Range Infra-Red Illuminator



- Distances up to 144m
- PLATINUM Elite SMT LED Technology
- Hot-spot Reduction Technology (HRT)
- VARIO Interchangeable Lens System
- VARIO Remote Control (optional)
- Angles from 10-120 degrees – from 1 product
- Semi-Covert (850nm) or Covert (940nm)
- Advanced Security Settings

Delivering world leading power and illumination distances VARIO2 next generation illuminators can improve the performance of any video surveillance system at night.

VARIO2 illuminators use PLATINUM Elite SMT LED technology to deliver more power and greater distances from a smaller platform than current generation illuminators. Providing a broader range of solutions, the VARIO2 series also offers a suite of advanced security features for easier programming and safer operation of smart lighting systems.

VARIO2 features an interchangeable lens system with Hot-spot Reduction Technology to deliver highly even illumination, where it is most needed, for outstanding night-time images. With the optional hand-held remote control, VARIO2 also makes installation and commissioning quicker, easier and safer.

The VARIO2 i4 Infra-Red series delivers maximum distances up to 144m (472ft).

## Product Dimensions

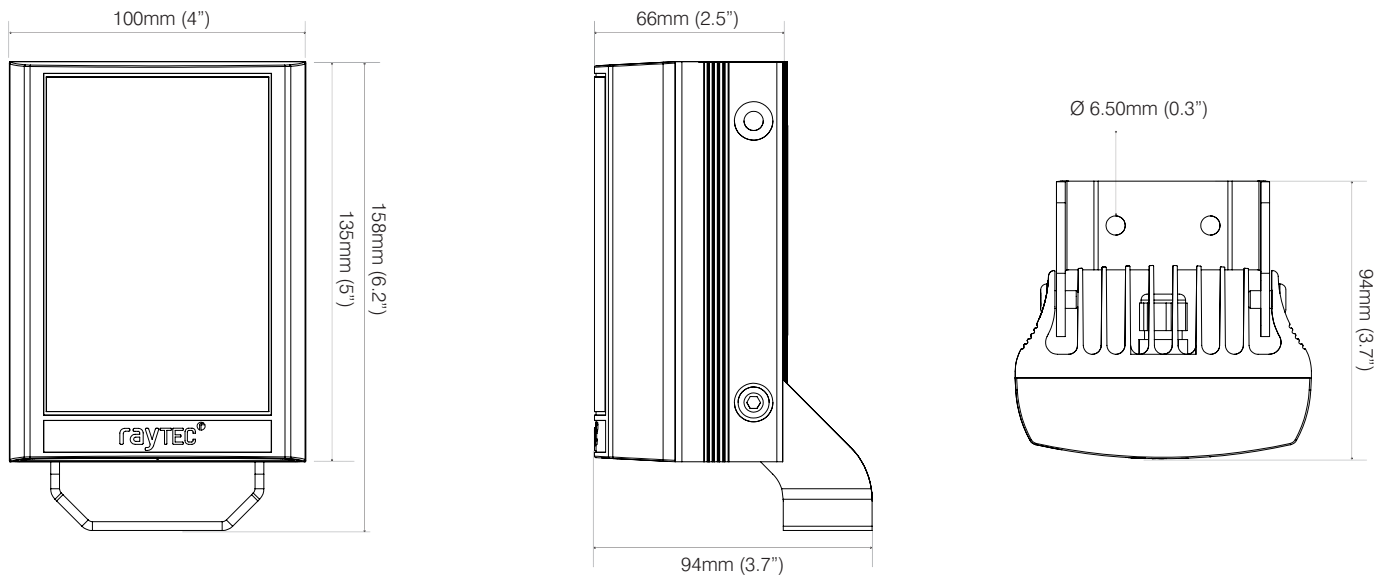

## Features

VARIO Interchangeable lens system

Hot-spot Reduction Technology (HRT)

VARIO Remote Control (optional)

LED Status Indicator

Platinum Elite SMT LED Technology

Advanced Security Settings

Green Technology

## Benefits

Angle of illumination can be easily, quickly and precisely adjusted by changing the VARIO holographic lens insert, to match the specific camera field of view.

HRT - Hot-Spot Reduction Technology delivers a highly diffused, elliptical beam shape to deliver more light where it is needed, generating both longer distances and minimizing light wastage. The HRT system also prevents overexposure of foreground objects.

Allows set up quickly and safely from ground level and provides access to advanced set up features. Reduces both cost and time of installation and commissioning.

Quick operational feedback on status and performance of the illuminator. Allows simple and quick commissioning of the installation and easy maintenance reviews

VARIO2 illuminators use cutting edge PLATINUM Elite SMT LED technology together with an enhanced Cool Running™ thermal management system to deliver World leading power, reliability and flexibility.

Programming inputs on both the VARIO remote control and on the VARIO2 illuminator can be disabled if required. Additionally, the VARIO remote control can be given a PIN code to lock in settings and limit access.

In-built green features such as power adjust, telemetry control and timer function enhance the potential for energy savings.

## 5 YEAR WARRANTY

All Raytec luminaires are provided with an industry leading 5 year warranty and have an expected useful life in excess of 10 years



# Technical Specifications

## Illuminator

Max Distance	144m (472ft)
Angle	Standard pack includes 10° circular + 35° x 10° (fitted as standard) and 60° x 25° elliptical lenses. Additional optional lenses: 80° x 30°, 120° x 50°
Input	12/24V AC/DC
Voltage	13.5V current controlled
Beam Shape	Elliptical with HRT (Hot-spot Reduction Technology)
Beam Angle System	VARIO Interchangeable Lens System
Consumption	13W max
LED type	Platinum Elite SMT LEDs
Number of LEDs	9
Wavelength	850nm (940nm options available)
IP rating	IP66
Temperature Range	-50° to +50°C (-58 to 122°F)
Colour	Black
Weight	950g (2.1lbs)
Dimensions	100 x 135 x 66mm (4" x 5" x 2.5" approx.)
Cable Length	2.5m
Bracketry	U bracket included VUB Bracketry also available (Optional)
Country of Manufacture	United Kingdom

## Integrated Command and Control Technology

Integrated Standard Features	<ul style="list-style-type: none"> <li>• Power adjust from 20-100%</li> <li>• In-built photocell for automatic on/off operation</li> <li>• Photocell following output</li> <li>• Photocell sensitivity adjust</li> <li>• LED status indicator provides status on performance of the unit</li> <li>• LED status indicator on/off</li> <li>• Disable programming mode</li> </ul>
Advanced Features (accessed via VARIO remote control)	<ul style="list-style-type: none"> <li>• Timer function (up to 30 mins)</li> <li>• Telemetry control</li> <li>• Remote Dimming</li> <li>• Restore factory default settings</li> <li>• Optional PIN to lock in settings and limit access</li> <li>• Remote Control can be disabled for improved security</li> </ul>

## POWERS – The Open Lighting Standard

Specifications and distances based on the POWERS lighting standard  
For more information on POWERS click [here](#)

For full POWERS data and A&E specifications please contact  
[sales@rayteccctv.com](mailto:sales@rayteccctv.com)

## Product Codes

Part Codes	Description	Angles	Distances
VAR2-i4-1	VARIO2 i4, 850nm, with 3 angle options included, 12-24V	10 x 10°	144m (472ft)
		35 x 10° (fitted as standard)	78m (256ft)
		60 x 25°	54m (177ft)
		80 x 30° (optional)	36m (118ft)
		120 x 50° (optional)	24m (79ft)
VAR2-i4-1-c	VARIO2 i4, 940nm, with 3 angle options included, 12-24V	10 x 10°	Contact Raytec
		35 x 10° (fitted as standard)	Contact Raytec
		60 x 25°	Contact Raytec
		80 x 30° (optional)	Contact Raytec
		120 x 50° (optional)	Contact Raytec

## Optional Parts

VAR-rc	Remote Control for any VARIO Illuminator (only 1 remote needed)
VAR-i4-LENS-8030	Individual i4 VARIO lens – 80°H x 30°V
VAR-i4-LENS-12050	Individual i4 VARIO lens – 120°H x 50°V